

HOLOGIC®



ThinPrep® Genesis™ Processor

Operator's Manual



ThinPrep® Genesis™ Processor Operator's Manual

HOLOGIC®



Hologic, Inc.
250 Campus Drive
Marlborough, MA 01752 USA
Tel: 1-800-442-9892
1-508-263-2900
Fax: 1-508-229-2795
Web: www.hologic.com

Caution: Federal law restricts this device to sale by or on the order of a physician, or any other practitioner licensed by the law of the State in which the practitioner practices to use or order the use of the device and are trained and experienced in the use of the ThinPrep Genesis Processor

Preparation of microscope slides using the ThinPrep Genesis Processor should be performed only by personnel who have been trained by Hologic or by organizations or individuals designated by Hologic.

Evaluation of microscope slides produced with the ThinPrep Genesis Processor should be performed only by cytotechnologists and pathologists who have been trained to evaluate ThinPrep prepared slides by Hologic or by organizations or individuals designated by Hologic.

© Hologic, Inc., 2023. All rights reserved.

Although this guide has been prepared with every precaution to ensure accuracy, Hologic assumes no liability for any errors or omissions, nor for any damages resulting from the application or use of this information.

This product may be covered by one or more U.S. patents identified at <http://hologic.com/patentinformation>

Hologic, Aptima, CytoLyt, Genesis, PreservCyt and ThinPrep are trademarks and/or registered trademarks of Hologic, Inc. or its subsidiaries in the United States and other countries. All other trademarks are the property of their respective owners.

Caution: Changes or modifications to this unit not expressly approved by the party responsible for compliance could void the user's authority to operate the equipment.

Document number: AW-17235-003 Rev. 003
1-2023



Instructions For Use

Instructions For Use

ThinPrep® Genesis™ Processor

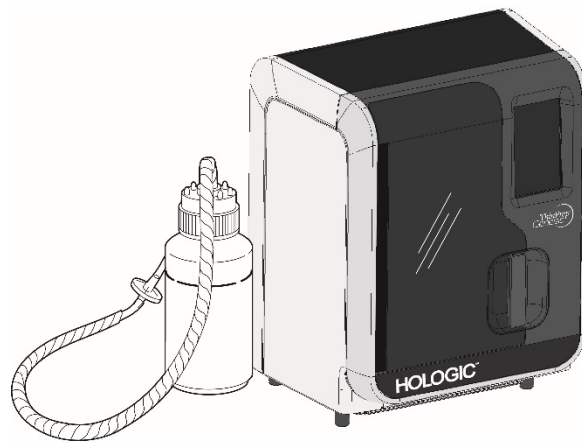

Instructions for Use

IVD

INTENDED USE

The ThinPrep Genesis processor is an integral part of the ThinPrep® system. The ThinPrep Genesis processor is used to prepare ThinPrep® microscope slides from ThinPrep® PreservCyt® vials to screen for the presence of atypical cells, cervical cancer or its precursor lesions (Low-grade Squamous Intraepithelial Lesions, High-grade Squamous Intraepithelial Lesions), as well as all other cytologic categories, including adenocarcinoma, as defined by *The Bethesda System for Reporting Cervical Cytology*¹.

The ThinPrep Genesis processor is also used to prepare ThinPrep slides from non-gynecologic (non-gyn) samples, including urine samples, and it can also be used to pipette an aliquot from the sample vial to a specimen transfer tube.

For professional use only.

SUMMARY AND EXPLANATION OF THE SYSTEM

The ThinPrep process begins with the patient's gynecologic sample being collected by the clinician using a cervical sampling device which, rather than being smeared on a microscope slide, is immersed and rinsed in a vial filled with 20 ml of PreservCyt® Solution (PreservCyt). The ThinPrep sample vial is then capped, labeled, and sent to a laboratory equipped with a ThinPrep Genesis processor.

At the laboratory, the PreservCyt sample vial is placed into a ThinPrep Genesis processor. A laboratory can elect to set up the ThinPrep Genesis processor to track the chain of custody for the sample, and to set up printing IDs on each glass microscope slide. Specimens are processed from the PreservCyt sample vial by one of three processes: "Aliquot + Slide", "Aliquot", or "Slide." In the Slide process, a cytology slide is prepared from the PreservCyt sample vial. In the Aliquot process, the ThinPrep Genesis processor can remove a 1-ml aliquot from the sample vial and transfer the aliquot to a specimen transfer tube. In the Aliquot + Slide process, the ThinPrep Genesis processor first transfers a 1-ml aliquot to a specimen transfer tube and then prepares a cytology slide. If a manual aliquot is prepared, the Slide process should be used.

A gentle dispersion step mixes the cell sample by currents in the fluid that are strong enough to separate debris and disperse mucus, but gentle enough to have no adverse effect on cell appearance.

The cells are then captured on a gynecological ThinPrep Pap test filter that is specifically designed to collect cells. The ThinPrep Genesis processor constantly monitors the rate of flow through the ThinPrep Pap test filter during the collection process to prevent the cellular presentation from being too scant or too dense. A thin layer of cells is then transferred to a glass slide in a 20 mm-diameter circle, and the slide is automatically deposited into a fixative solution.

The ThinPrep Sample Preparation Process

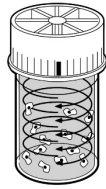

(1) Dispersion

The sample vial is rotated, creating currents in the fluid that are strong enough to separate debris and disperse mucus, but gentle enough to have no adverse effect on cell appearance.

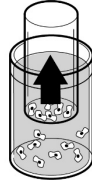

(2) Cell Collection

A gentle vacuum is created within the ThinPrep Pap test filter, which collects cells on the exterior surface of the membrane. Cell collection is controlled by the ThinPrep Genesis processor's software that monitors the rate of flow through the ThinPrep Pap test filter.

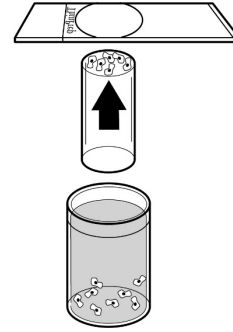

(3) Cell Transfer

After the cells are collected on the membrane, the ThinPrep filter is inverted and gently pressed against the ThinPrep microscope slide. Natural attraction and slight positive air pressure cause the cells to adhere to the ThinPrep microscope slide resulting in an even distribution of cells in a defined circular area.

As with conventional Pap smears, slides prepared with the ThinPrep® Genesis processor are examined in the context of the patient's clinical history and information provided by other diagnostic procedures such as colposcopy, biopsy, and human papillomavirus (HPV) testing, to determine patient management.

The PreservCyt® Solution component of the ThinPrep Genesis processor is an alternative collection and transport medium for the testing of Human Papilloma Virus (HPV) and sexually transmitted infections (STIs) in gynecological specimens, including, but not limited to:

Chlamydia trachomatis and Neisseria gonorrhoeae (Aptima Combo 2® assay),
Chlamydia trachomatis (Aptima® CT assay),
Neisseria gonorrhoeae (Aptima® GC assay),
Mycoplasma genitalium (Aptima® Mycoplasma genitalium assay),
Trichomonas vaginalis (Aptima® Trichomonas vaginalis assay),
Human papillomavirus (Aptima® HPV assay), and
Human papillomavirus (Aptima® HPV 16 18/45 genotype assay)

Note: Refer to the respective manufacturer's package inserts for instructions for using PreservCyt Solution for collection, transport, storage, and preparation of specimens for use in those systems.

In addition to preparing a slide from a PreservCyt sample vial, the ThinPrep Genesis processor has the ability to remove a 1-ml aliquot from the sample vial and transfer the aliquot to a specimen transfer tube.

The ThinPrep Genesis processor is also used to prepare ThinPrep slides from non-gynecologic (non-gyn) samples.

LIMITATIONS

- Gynecologic samples collected for preparation using the ThinPrep Genesis processor should be collected using a broom-type or endocervical brush/plastic spatula combination collection devices. Refer to the instructions provided with the collection device for warnings, contraindications, and limitations associated with specimen collection.
- Preparation of microscope slides using the ThinPrep Genesis processor should be performed only by personnel who have been trained by Hologic or by organizations or individuals designated by Hologic.
- Evaluation of microscope slides produced with the ThinPrep Genesis processor should be performed only by cytotechnologists and pathologists who have been trained to evaluate ThinPrep prepared slides by Hologic or by organizations or individuals designated by Hologic.
- Supplies used by the ThinPrep Genesis processor are those designed and supplied by Hologic specifically for the ThinPrep Genesis processor. These include PreservCyt Solution vials, ThinPrep Pap test filters, ThinPrep microscope slides, and tubes for the aliquot. These supplies are required for proper performance of the system and cannot be substituted. Product performance will be compromised if other supplies are used. After use, supplies should be disposed of in accordance with local, state, and federal regulations.
- A ThinPrep Pap test filter must be used only once and cannot be reused.
- A ThinPrep microscope slide can be used only once. The slide can only have cells transferred onto it once.
- Aliquots taken by the ThinPrep Genesis processor have not been evaluated for specific assays. Please refer to the instructions provided with a specific assay.
- The performance of HPV and STI ancillary testing on sample vials reprocessed using glacial acetic acid has not been evaluated.

WARNINGS

- For In Vitro Diagnostic Use
- Danger. PreservCyt Solution contains methanol. Toxic if swallowed. Toxic if inhaled. Causes damage to organs. Flammable liquid and vapor. Keep away from heat, sparks, open flames and hot surfaces. Other solutions cannot be substituted for PreservCyt

Solution. PreservCyt Solution should be stored and disposed of in accordance with all applicable regulations.

- Do not process a cerebral spinal fluid (CSF) specimen or other sample type that is suspected of possessing prion infectivity (PrPsc) derived from a person with a TSE, such as Creutzfeldt- Jakob disease, on the ThinPrep Genesis processor. A TSE-contaminated processor cannot be effectively decontaminated and therefore must be properly disposed of in order to avoid potential harm to users of the processor or service personnel.
- Strong oxidizers, such as bleach, are incompatible with PreservCyt Solution and therefore should not be used to clean the waste bottle.

PRECAUTIONS

- This equipment generates, uses and can radiate radio frequency energy, and if not installed and used in accordance with the operator's manual, may cause interference to radio communications. Operation of this equipment in a residential area is likely to cause harmful interference, in which case the user will be required to correct the interference at his/her own expense.
- PreservCyt Solution *with* cytologic sample intended for ThinPrep Pap testing must be stored between 15°C (59°F) and 30°C (86°F) and tested within 6 weeks of collection.
- Testing for certain sexually transmitted infections (STIs) and for Human Papilloma Virus (HPV) in conjunction with cytology may be performed. Refer to assay specific guidance for the collection, transport, and storage conditions of specimens for use in those systems.
- PreservCyt Solution was challenged with a variety of microbial and viral organisms. The following table presents the starting concentrations of viable organisms, and the log reduction of viable organisms found after 15 minutes in the PreservCyt Solution. As with all laboratory procedures, universal precautions should be followed.

Organism	Initial Concentration	Log Reduction After 15 Minutes
<i>Candida albicans</i>	5.5 x 10 ⁵ CFU/ml	≥4.7
<i>Candida auris</i>	2.6 x 10 ⁵ CFU/ml	≥5.4
<i>Aspergillus niger</i>	4.8 x 10 ⁵ CFU/ml	2.7*
<i>Escherichia coli</i>	2.8 x 10 ⁵ CFU/ml	≥4.4
<i>Staphylococcus aureus</i>	2.3 x 10 ⁵ CFU/ml	≥4.4
<i>Pseudomonas aeruginosa</i>	2.5 x 10 ⁵ CFU/ml	≥4.4
<i>Mycobacterium tuberculosis</i> [†]	9.4 x 10 ⁵ CFU/ml	4.9**

Organism	Initial Concentration	Log Reduction After 15 Minutes
Rabbitpox virus	6.0 x 10 ⁶ PFU/ml	5.5***
HIV-1	3.2 x 10 ⁷ TCID ₅₀ /ml	≥7.0***
Hepatitis B virus [†]	2.2 x 10 ⁶ TCID ₅₀ /ml	≥4.25
SARS-CoV-2 virus	1.8 x 10 ⁶ TCID ₅₀ /ml	≥3.75
<p>* After 1 hour 4.7 log reduction ** After 1 hour 5.7 log reduction *** Data is for 5 minutes [†] Organisms were tested with similar organisms from the same genus to assess antimicrobial effectiveness</p>		
<p>Note: All log reduction values with a ≥ designation yielded undetectable microbial presence after exposure to PreservCyt Solution. The listed values represent the minimum allowable claim given the initial concentration and the detection limit of the quantitative method.</p>		

PERFORMANCE CHARACTERISTICS: REPORT OF CLINICAL STUDIES

The ThinPrep Genesis processor uses similar cell collection and slide preparation technology as the ThinPrep 2000 system. The performance characteristics of the ThinPrep Genesis processor are predicated on those of the ThinPrep 2000 system. Both clinical studies for the ThinPrep 2000 system and those comparing the ThinPrep Genesis processor to the ThinPrep 2000 system are described in the following sections.

ThinPrep 2000 System Compared to Conventional Pap Smear

A prospective multi-center clinical study was conducted to evaluate the performance of the ThinPrep 2000 system in direct comparison to the conventional Pap smear. The objective of the ThinPrep clinical study was to demonstrate that gynecologic specimens prepared using the ThinPrep 2000 system were at least as effective as conventional Pap smears for the detection of atypical cells and cervical cancer or its precursor lesions in a variety of patient populations. In addition, an assessment of specimen adequacy was performed.

The initial clinical study protocol was a blinded, split sample, matched pair study, for which a conventional Pap smear was prepared first, and the remainder of the sample (the portion that normally would have been discarded) was immersed and rinsed into a vial of PreservCyt Solution. At the laboratory, the PreservCyt sample vial was placed into a ThinPrep 2000 system and a slide was then prepared from the patient's sample. ThinPrep and conventional Pap smear slides were examined and diagnosed independently. Reporting forms containing patient history as well as a

checklist of all possible categories of The Bethesda System were used to record the results of the screening. A single independent pathologist reviewed all discrepant and positive slides from all sites in a blinded fashion to provide a further objective review of the results.

Since the time of the ThinPrep 2000 system study, terminology in The Bethesda System categories was revised. The data below retains the terminology from the original study.

LABORATORY AND PATIENT CHARACTERISTICS

Cytology laboratories at three screening centers (designated as S1, S2, and S3) and three hospital centers (designated as H1, H2, and H3) participated in the clinical study. The screening centers in the study serve patient populations (screening populations) with rates of abnormality (Low-grade Squamous Intraepithelial Lesion [LSIL] and more severe lesions) similar to the United States average of less than 5%.² The hospital centers in the study serve a high-risk referral patient population (hospital populations) characterized by high rates (>10%) of cervical abnormality. Data on race demographics was obtained for 70% of the patients that participated in the study. The study population consisted of the following race groups: Caucasian (41.2%), Asian (2.3%), Hispanic (9.7%), African American (15.2%), Native American (1.0%) and other groups (0.6%).

Table 1 describes the laboratories and the patient populations.

Table 1: Site Characteristics (ThinPrep 2000 System Study)

Site	Laboratory Characteristics			Clinical Study Demographics			
	Type of Patient Population	Laboratory Volume - Smears per Year	Cases	Patient Age Range	Post-Menopausal	Previous Abnormal Pap Smear	Convent. Prevalence LSIL+
S1	Screening	300,000	1,386	18.0 - 84.0	10.6%	8.8%	2.3%
S2	Screening	100,000	1,668	18.0 - 60.6	0.3%	10.7%	2.9%
S3	Screening	96,000	1,093	18.0 - 48.8	0.0%	7.1%	3.8%
H1	Hospital	35,000	1,046	18.1 - 89.1	8.1%	40.4%	9.9%
H2	Hospital	40,000	1,049	18.1 - 84.4	2.1%	18.8%	12.9%
H3	Hospital	37,000	981	18.2 - 78.8	11.1%	38.2%	24.2%

CLINICAL STUDY RESULTS

The diagnostic categories of The Bethesda System were used as the basis of the comparison between conventional and ThinPrep® findings from the clinical study. The diagnostic classification data and statistical analyses for all clinical sites are presented in Tables 2 through 11. Cases with incorrect paperwork, patient's age less than 18 years, cytologically unsatisfactory slides, or patients with a hysterectomy were excluded from this analysis. Few cases of cervical cancer (0.02%³) were represented in the clinical study, as is typical in the United States patient population.

Table 2: Diagnostic Classification Table, All Categories (ThinPrep 2000 System Study)

		Conventional							TOTAL
		NEG	ASCUS	AGUS	LSIL	HSIL	SQ CA	GL CA	
ThinPrep	NEG	5224	295	3	60	11	0	0	5593
	ASCUS	318	125	2	45	7	0	0	497
	AGUS	13	2	3	0	1	0	1	20
	LSIL	114	84	0	227	44	0	0	469
	HSIL	11	15	0	35	104	2	0	167
	SQ CA	0	0	0	0	0	1	0	1
	GL CA	0	0	0	0	0	0	0	0
	TOTAL	5680	521	8	367	167	3	1	6747

Abbreviations for Diagnoses: **NEG** = Normal or negative, **ASCUS** = Atypical Squamous Cells of Undetermined Significance, **AGUS** = Atypical Glandular Cells of Undetermined Significance, **LSIL** = Low-grade Squamous Intraepithelial Lesion, **HSIL** = High-grade Squamous Intraepithelial Lesion, **SQ CA** = Squamous Cell Carcinoma, **GL CA** = Glandular Cell Adenocarcinoma

Table 3: Three Category Diagnostic Classification Table (ThinPrep 2000 System Study)

		Conventional			
		NEG	ASCUS/AGUS+	LSIL+	TOTAL
ThinPrep	NEG	5224	298	71	5593
	ASCUS/AGUS+	331	132	54	517
	LSIL+	125	99	413	637
	TOTAL	5680	529	538	6747

Table 4: Two Category Diagnostic Classification Table, LSIL and More Severe Diagnoses (ThinPrep 2000 System Study)

		Conventional		
		NEG/ASCUS/AGUS+	LSIL+	TOTAL
ThinPrep	NEG/ASCUS/AGUS+	5985	125	6110
	LSIL+	224	413	637
	TOTAL	6209	538	6747

Table 5: Two Category Diagnostic Classification Table, ASCUS/AGUS and More Severe Diagnoses (ThinPrep 2000 System Study)

		NEG	ASCUS/AGUS+	TOTAL
ThinPrep	NEG	5224	369	5593
	ASCUS/AGUS+	456	698	1154
	TOTAL	5680	1067	6747

The diagnostic data analysis from the sites is summarized in Table 6 and 7. When the p-value is significant ($p < 0.05$), the method favored is indicated in the tables.

Table 6: Results by Site, LSIL and More Severe Lesions (ThinPrep 2000 System Study)

Site	Cases	ThinPrep LSIL+	Convent. LSIL+	Increased Detection*	p-Value	Method Favored
S1	1,336	46	31	48%	0.027	ThinPrep
S2	1,563	78	45	73%	<0.001	ThinPrep
S3	1,058	67	40	68%	<0.001	ThinPrep
H1	971	125	96	30%	<0.001	ThinPrep
H2	1,010	111	130	(15%)	0.135	Neither
H3	809	210	196	7%	0.374	Neither

$$*Increased\ detection = \frac{ThinPrep^{\circ} LSIL+ - Conventional LSIL+}{Conventional LSIL+} \times 100\%$$

For LSIL and more severe lesions, the diagnostic comparison statistically favored the ThinPrep[®] method at four sites and was statistically equivalent at two sites.

**Table 7: Results by Site, ASCUS/AGUS and More Severe Lesions
(ThinPrep 2000 System Study)**

Site	Cases	ThinPrep ASCUS+	Convent. ASCUS+	Increased Detection*	p-Value	Method Favored
S1	1,336	117	93	26%	0.067	Neither
S2	1,563	124	80	55%	<0.001	ThinPrep
S3	1,058	123	81	52%	<0.001	ThinPrep
H1	971	204	173	18%	0.007	ThinPrep
H2	1,010	259	282	(8%)	0.360	Neither
H3	809	327	358	(9%)	0.102	Neither

$$*Increased\ detection = \frac{ThinPrep^{\circ} ASCUS+ - Conventional\ ASCUS+}{Conventional\ ASCUS+} \times 100\%$$

For ASCUS/AGUS and more severe lesions, the diagnostic comparison statistically favored the ThinPrep method at three sites and was statistically equivalent at three sites.

One pathologist served as an independent reviewer for the six clinical sites, receiving both slides from cases where the two methods were either abnormal or discrepant. Since a true reference cannot be determined in such studies and therefore true sensitivity cannot be calculated, the use of an expert cytologic review provides an alternative to histologic confirmation by biopsy or human papillomavirus (HPV) testing as a means for determining the reference diagnosis.

The reference diagnosis was the more severe diagnosis from either of the ThinPrep or conventional Pap slides as determined by the independent pathologist. The number of slides diagnosed as abnormal at each site, compared to the reference diagnosis of the independent pathologist, provides the proportion of LSIL or more severe lesions (Table 8) and the proportion of ASCUS/AGUS or more severe lesions (Table 9). The statistical analysis allows a comparison of the two methods and a determination of which method is favored when using the independent pathologist for expert cytologic review as the adjudicator of the final diagnosis.

Table 8: Independent Pathologist Results by Site, LSIL and More Severe Lesions (ThinPrep 2000 System Study)

Site	Cases Positive by Independent Pathologist	ThinPrep Positive	Conventional Positive	p-Value	Method Favored
S1	50	33	25	0.0614	Neither
S2	65	48	33	0.0119	ThinPrep
S3	77	54	33	<0.001	ThinPrep
H1	116	102	81	<0.001	ThinPrep
H2	115	86	90	0.607	Neither
H3	126	120	112	0.061	Neither

For LSIL and more severe lesions, the diagnostic comparison statistically favored the ThinPrep method at three sites and was statistically equivalent at three sites.

Table 9: Independent Pathologist Results by Site, ASCUS/AGUS and More Severe Lesions (ThinPrep 2000 System Study)

Site	Cases Positive by Independent Pathologist	ThinPrep® Positive	Conventional Positive	p-Value	Method Favored
S1	92	72	68	0.0511	Neither
S2	101	85	59	0.001	ThinPrep
S3	109	95	65	<0.001	ThinPrep
H1	170	155	143	0.090	Neither
H2	171	143	154	0.136	Neither
H3	204	190	191	1.000	Neither

For ASCUS/AGUS and more severe lesions, the diagnostic comparison statistically favored the ThinPrep method at two sites and was statistically equivalent at four sites.

Table 10 below shows the summary for all sites of the descriptive diagnosis for all Bethesda System categories.

Table 10: Summary of Descriptive Diagnosis (ThinPrep 2000 System Study)

Descriptive Diagnosis <i>Number of Patients: 6747</i>	ThinPrep		Conventional	
	N	%	N	%
Benign Cellular Changes:	1592	23.6	1591	23.6
Infection:				
Trichomonas Vaginalis	136	2.0	185	2.7
Candida spp.	406	6.0	259	3.8
Coccobacilli	690	10.2	608	9.0
Actinomyces spp.	2	0.0	3	0.0
Herpes	3	0.0	8	0.1
Other	155	2.3	285	4.2
Reactive Cellular Changes				
Associated with:				
Inflammation	353	5.2	385	5.7
Atrophic Vaginitis	32	0.5	48	0.7
Radiation	2	0.0	1	0.0
Other	25	0.4	37	0.5
Epithelial Cell Abnormalities:	1159	17.2	1077	16.0
Squamous Cell:				
ASCUS	501	7.4	521	7.7
favor reactive	128	1.9	131	1.9
favor neoplastic	161	2.4	140	2.1
undetermined	213	3.2	250	3.7
LSIL	469	7.0	367	5.4
HSIL	167	2.5	167	2.5
Carcinoma	1	0.0	3	0.0
Glandular Cell:				
Benign Endometrial cells in Postmenopausal Women	7	0.1	10	0.1
Atypical Glandular Cells (AGUS)	21	0.3	9	0.1
favor reactive	9	0.1	4	0.1
favor neoplastic	0	0.0	3	0.0
undetermined	12	0.2	2	0.0
Endocervical Adenocarcinoma	0	0.0	1	0.0

Note: Some patients had more than one diagnostic subcategory.

Table 11 shows the rates of detection for infection, reactive changes, and the total benign cellular changes for both the ThinPrep® and conventional methods at all sites.

Table 11: Benign Cellular Changes Results (ThinPrep 2000 System Study)

	ThinPrep		Conventional	
	N	%	N	%
Benign Cellular Changes				
Infection	1392	20.6	1348	20.0
Reactive Changes	412	6.1	471	7.0
Total*	1592	23.6	1591	23.6

** Total includes some patients that may have had both an infection and reactive cellular change.*

Tables 12, 13, and 14 show the specimen adequacy results for the ThinPrep method and conventional smear method for all of the study sites. Of the 7,360 total patients enrolled, 7,223 are included in this analysis. Cases with patient's age less than 18 years or patients with a hysterectomy were excluded from this analysis.

Two additional clinical studies were conducted to evaluate specimen adequacy results when samples were deposited directly into the PreservCyt® vial, without first making a conventional Pap smear. This specimen collection technique is the intended use for the ThinPrep 2000 system. Tables 15 and 16 present the split sample and direct to vial results.

Table 12: Summary of Specimen Adequacy Results (ThinPrep 2000 System Study)

Specimen Adequacy Number of Patients: 7223	ThinPrep		Conventional	
	N	%	N	%
Satisfactory	5656	78.3	5101	70.6
Satisfactory for Evaluation but Limited by:	1431	19.8	2008	27.8
Air-Drying Artifact	1	0.0	136	1.9
Thick Smear	9	0.1	65	0.9
Endocervical Component Absent	1140	15.8	681	9.4
Scant Squamous Epithelial Component	150	2.1	47	0.7
Obscuring Blood	55	0.8	339	4.7
Obscuring Inflammation	141	2.0	1008	14.0
No Clinical History	12	0.2	6	0.1
Cytolysis	19	0.3	119	1.6
Other	10	0.1	26	0.4
Unsatisfactory for Evaluation:	136	1.9	114	1.6
Air-Drying Artifact	0	0.0	13	0.2
Thick Smear	0	0.0	7	0.1
Endocervical Component Absent	25	0.3	11	0.2
Scant Squamous Epithelial Component	106	1.5	47	0.7
Obscuring Blood	23	0.3	58	0.8
Obscuring Inflammation	5	0.1	41	0.6
No Clinical History	0	0.0	0	0.0
Cytolysis	0	0.0	4	0.1
Other	31	0.4	9	0.1

Note: Some patients had more than one subcategory.

Table 13: Specimen Adequacy Results (ThinPrep 2000 System Study)

		Conventional			
		SAT	SBLB	UNSAT	TOTAL
ThinPrep	SAT	4316	1302	38	5656
	SBLB	722	665	44	1431
	UNSAT	63	41	32	136
	TOTAL	5101	2008	114	7223

SAT=Satisfactory, SBLB=Satisfactory But Limited By, UNSAT=Unsatisfactory

Table 14: Specimen Adequacy Results by Site (ThinPrep 2000 System Study)

Site	Cases	ThinPrep SAT Cases	Convent. SAT Cases	ThinPrep SBLB Cases	Convent. SBLB Cases	ThinPrep UNSAT Cases	Convent. UNSAT Cases
S1	1,386	1092	1178	265	204	29	4
S2	1,668	1530	1477	130	178	8	13
S3	1,093	896	650	183	432	14	11
H1	1,046	760	660	266	375	20	11
H2	1,049	709	712	323	330	17	7
H3	981	669	424	264	489	48	68
All Sites	7,223	5656	5101	1431	2008	136	114

The Satisfactory But Limited By (SBLB) category can be broken down into many subcategories, one of which is the absence of Endocervical Component. Table 15 shows the Satisfactory But Limited By category “No ECC’s” for ThinPrep® and conventional slides.

Table 15: Specimen Adequacy Results by Site, SBLB Rates for no Endocervical Component (ThinPrep 2000 System Study)

SBLB Due to No ECC's					
Site	Cases	ThinPrep SBLB-no ECC's	ThinPrep SBLB-no ECC's (%)	Conventional SBLB-no ECC's	Conventional SBLB-no ECC's (%)
S1	1,386	237	17.1%	162	11.7%
S2	1,668	104	6.2%	73	4.4%
S3	1,093	145	13.3%	84	7.7%
H1	1,046	229	21.9%	115	11.0%
H2	1,049	305	29.1%	150	14.3%
H3	981	120	12.2%	97	9.9%
All Sites	7,223	1140	15.8%	681	9.4%

For the results of the clinical study involving a split-sample protocol, there was a 6.4 percent difference between conventional and ThinPrep methods in detecting endocervical component. This is similar to previous studies using a split sample methodology.

DIRECT-TO-VIAL ENDOCERVICAL COMPONENT (ECC) STUDIES

For the intended use of the ThinPrep® 2000 system, the cervical sampling device will be rinsed directly into a PreservCyt® vial, rather than splitting the cellular sample. It was expected that this

would result in an increase in the pick-up of endocervical cells and metaplastic cells. To verify this hypothesis, two studies were performed using the direct-to-vial method and are summarized in Table 16. Overall, no difference was found between ThinPrep and conventional methods in these two studies.

Table 16: Summary of Direct-to-Vial Endocervical Component (ECC) Studies (ThinPrep 2000 System Study)

Study	Number of Evaluable Patients	SBLB due to No Endocervical Component	Comparable Conventional Pap Smear Percentage
Direct-to-Vial Feasibility	299	9.36%	9.43% ¹
Direct-to-Vial Clinical Study	484	4.96%	4.38% ²

1. Direct-to-Vial Feasibility study compared to overall clinical investigation conventional Pap smear SBLB-No Endocervical Component rate.

2. Direct-to-Vial Clinical study compared to site S2 clinical investigation conventional Pap smear SBLB-No Endocervical Component rate.

DIRECT-TO-VIAL HSIL+ STUDY

Following initial FDA approval of the ThinPrep system, Hologic conducted a multi-site direct-to-vial clinical study to evaluate the ThinPrep 2000 system versus conventional Pap smear for the detection of High Grade Squamous Intraepithelial and more severe lesions (HSIL+). Two types of patient groups were enrolled in the trial from ten (10) leading academic hospitals in major metropolitan areas throughout the United States. From each site, one group consisted of patients that were representative of a routine Pap test screening population and the other group made up of patients representative of a referral population enrolled at the time of colposcopic examination. The ThinPrep specimens were collected prospectively and compared against a historical control cohort. The historical cohort consisted of data collected from the same clinics and clinicians (if available) used to collect the ThinPrep specimens. These data were collected sequentially from patients seen immediately prior to the initiation of the study.

The results from this study showed a detection rate of 511 / 20,917 for the conventional Pap smear versus 399 / 10,226 for the ThinPrep slides. For these clinical sites and these study populations, this indicates a 59.7% increase in detection of HSIL+ lesions for the ThinPrep specimens. These results are summarized in Table 17.

Table 17: Summary of Direct-to-Vial HSIL+ Study (ThinPrep 2000 System)

Site	Total CP (n)	HSIL+	Percent (%)	Total TP (n)	HSIL+	Percent (%)	Percent Change (%)
S1	2,439	51	2.1	1,218	26	2.1	+2.1
S2	2,075	44	2.1	1,001	57	5.7	+168.5
S3	2,034	7	0.3	1,016	16	1.6	+357.6
S4	2,043	14	0.7	1,000	19	1.9	+177.3
S5	2,040	166	8.1	1,004	98	9.8	+20.0
S6	2,011	37	1.8	1,004	39	3.9	+111.1
S7	2,221	58	2.6	1,000	45	4.5	+72.3
S8	2,039	61	3.0	983	44	4.5	+49.6
S9	2,000	4	0.2	1,000	5	0.5	+150.0
S10	2,015	69	3.4	1,000	50	5.0	+46.0
Total	20,917	511	2.4	10,226	399	3.9	59.7(p<0.001)

$$\text{Percent Change (\%)} = ((\text{TP HSIL+}/\text{TP Total})/(\text{CP HSIL+}/\text{CP Total})-1) * 100$$

GLANDULAR DISEASE DETECTION – PUBLISHED STUDIES

The detection of endocervical glandular lesions is an essential function of the Pap test. However, abnormal glandular cells in the Pap sample may also originate from the endometrium or from extrauterine sites. The Pap test is not intended to be a screening test for such lesions.

When suspected glandular abnormalities are identified, their accurate classification as true glandular versus squamous lesions is important for proper evaluation and subsequent treatment (e.g., choice of excisional biopsy method versus conservative follow-up). Multiple peer-reviewed publications⁴⁻⁹ report on the improved ability of the ThinPrep 2000 system to detect glandular disease versus the conventional Pap smear. Although these studies do not consistently address sensitivity of different Pap testing methods in detecting specific types of glandular disease, the reported results are consistent with more frequent biopsy confirmation of abnormal glandular findings by the ThinPrep Pap Test compared to conventional cytology.

Thus, the finding of a glandular abnormality on a ThinPrep Pap Test slide merits increased attention for definitive evaluation of potential endocervical or endometrial pathology.

ThinPrep Genesis Processor Compared to ThinPrep 2000 System

A multi-center clinical study was conducted to evaluate the performance of the ThinPrep Genesis processor in direct comparison to the ThinPrep 2000 system. The objective of the ThinPrep clinical study was to estimate the Positive Percent Agreement (PPA) and Negative Percent Agreement (NPA) for gynecologic specimens prepared using the ThinPrep Genesis processor as compared with processing using the ThinPrep 2000 system.

CLINICAL STUDY DESIGN

This study was a multi-center, split-sample, blinded evaluation of pairs of ThinPrep slides generated from the ThinPrep 2000 system and ThinPrep Genesis processor from the same residual cytological specimen. The study was conducted at three (3) laboratories in the United States. All study specimens were processed on both a ThinPrep 2000 system (TP-2000) and a ThinPrep Genesis processor using “Slide Only” process. All slides were reviewed independently by three (3) cytotechnologists (CT) and three (3) pathologists at each site. Following manual review, all slides were adjudicated by an independent site, the fourth site. All cytological diagnoses were determined in accordance with the Bethesda System criteria for all slides.

1,260 patients' ThinPrep Pap Test specimens were enrolled in this study. 1,260 samples were enrolled from February 2019 through June 2020. Each study site enrolled 420 specimens selected from their residual inventory (population of gynecological ThinPrep Pap Test specimens sent to the study sites' cytology laboratory). The samples for the study included specimens in each of the diagnostic categories being evaluated. Each study site produced 2 slides per specimen, 1 slide prepared on the ThinPrep Genesis processor and 1 slide prepared on the TP-2000 processor, yielding 840 slides (420 pairs of slides) per site for diagnostic review. A total of 2,520 slides were analyzed for the study. The order in which the slides were processed was randomized. All slides were stained, coverslipped, and read manually following standard laboratory procedures; all slides prepared at the site were reviewed independently by each of three (3) pairs of cytotechnologists/pathologists. All cytologic diagnoses were determined in accordance with Bethesda System 2001 criteria.

LABORATORY AND PATIENT CHARACTERISTICS

Of the 1260 specimens enrolled, 7 specimens were excluded (3 specimens were excluded because of expiration time and 4 specimens were excluded because there were no adjudication results). Total number of specimens for an evaluation of the ThinPrep Genesis processor was 1253. The study population included women with median age \approx 36 years, \approx 7% of women were postmenopausal and \approx 2% of women had hysterectomy. Table 18 describes the patient populations at each of the study sites:

Table 18: Clinical Study Characteristics

Parameter	Statistic	Site 1 (N=417)	Site 2 (N=418)	Site 3 (N=418)	All Sites (N=1253)
Age (years)	n	417	418	418	1253
	Mean	38.7	39.9	38.7	39.1
	SD	12.89	12.71	13.97	13.20
	Median	36.0	38.0	35.0	36.0
	Min - Max	20 - 78	18 - 82	15 - 82	15 - 82
Postmenopausal					
Yes	n (%)	19 (4.6)	31 (7.7)	35 (8.4)	85 (6.9)
No	n (%)	398 (95.4)	386 (92.3)	383 (91.6)	1167 (93.1)
Hysterectomy					
Yes	n (%)	5 (1.2)	3 (0.7)	18 (4.3)	26 (2.1)
No	n (%)	412 (98.8)	415 (99.3)	400 (95.7)	1227 (97.9)

REFERENCE DIAGNOSIS BY ADJUDICATION REVIEW

After all study slides were reviewed, the ThinPrep Genesis slides and ThinPrep 2000 slides were subject to an adjudication review. Adjudication was done at a facility that was not one of the study sites conducting the study. Slides for adjudication were evenly divided between three adjudication panels each consisting of one (1) cytotechnologist and three (3) independent pathologists. Each adjudication panel reviewed one-third of the slides prepared from each study site for a total of 2512 slides. Each adjudication panel was blinded to the original review diagnosis for all slides and each independent pathologist within each panel was also blinded to other adjudicator's diagnoses for all slides. Adjudication consensus agreement was obtained for each

slide reviewed. Consensus agreement was achieved when at least two of the three pathologists from a panel rendered an identical diagnosis. In cases where the pathologist review process did not reach a consensus, the panel of pathologists was brought together at a multi-headed microscope to manually review those slides for consensus diagnosis. Each panel of pathologists participating in the multi-head review was blinded to all previous diagnoses obtained in the adjudication review.

Adjudicated results for both the ThinPrep 2000 system and the Genesis processor are presented in Table 19.

Table 19: Adjudicated ThinPrep Genesis Processor Diagnosis vs Adjudicated ThinPrep 2000 System Diagnosis (Combined Sites)

		Adjudicated Results (ThinPrep 2000 System)							Total	
		UNSAT	NILM	ASCUS	AGUS	LSIL	ASC-H	HSIL		Cancer
Adjudicated Results (ThinPrep Genesis Processor)	UNSAT	2	2	0	0	0	0	1	0	5
	NILM	3	593	65	4	10	11	4	1	691
	ASCUS	1	69	48	2	25	2	2	1	150
	AGUS	0	2	0	0	0	1	1	1	5
	LSIL	0	10	27	0	143	2	18	0	200
	ASC-H	0	6	6	2	2	6	9	1	32
	HSIL	0	1	4	1	10	13	113	6	148
	Cancer	0	0	0	2	0	2	4	14	22
	Total	6	683	150	11	190	37	152	24	1253

Nine (9) sample vials had UNSAT either with ThinPrep Genesis processor, with ThinPrep 2000 system, or with both. Using the severity ordering of the diagnostic result (NILM, ASC-US, AGUS, LSIL, ASC-H, HSIL, Cancer), a single reference diagnosis was formed for each sample vial (specimen) by choosing the most severe of the diagnoses in each pair to create the adjudication reference (“truth”) result for each sample, or slide pair. In the study, there were 32 Cancer, 176 HSIL, 38 ASC-H, 215 LSIL, 8 AGUS, 182 ASC-US, and 593 NILM specimens. Clinical sensitivity and specificity (e.g., with reference to a histological diagnosis) cannot be measured in this study which relied on cytological examination alone. Instead, laboratory positive and negative diagnoses by both methods, ThinPrep Genesis processor and ThinPrep 2000 system, for the specimens with Reference Diagnosis of ASC-US+ (combined ASC-US, AGUS, LSIL, ASC-H, HSIL, and Cancer), LSIL+ (combined LSIL, ASC-H, HSIL, and Cancer), ASC-H+ (combined ASC-H, HSIL, and Cancer), HSIL+ (combined HSIL and Cancer) and Cancer were compared.

CLINICAL STUDY RESULTS

Tables 20 through 29 present the comparison of Laboratory true positive and true negative rates for ASC-US+, LSIL+, ASC-H+, HSIL+ and Cancer for the first pair of cytotechnologist/pathologist at each site and combined for the three sites for the first pair of cytotechnologist/pathologist data.

1. Reference Diagnosis ASC-US+

In the study, there were 651 specimens with Reference Diagnosis of ASC-US+ (combined ASC-US, AGUS, LSIL, ASC-H, HSIL and Cancer) and 593 specimens with Reference Diagnosis of NILM.

Table 20: Laboratory ThinPrep Genesis Results vs Laboratory ThinPrep 2000 Results for the Specimens with Reference Diagnosis of ASC-US+

		Laboratory ThinPrep 2000								
		UNSAT	NILM	ASCUS	AGUS	LSIL	ASC-H	HSIL	Cancer	Total
Laboratory ThinPrep Genesis	UNSAT	0	1	0	0	1	0	1	0	3
	NILM	1	148	26	0	6	6	2	1	190
	ASCUS	0	30	50	0	22	8	2	0	112
	AGUS	0	2	0	1	0	1	1	0	5
	LSIL	0	9	12	0	106	2	7	0	136
	ASC-H	0	5	6	0	3	16	12	1	43
	HSIL	0	4	3	0	7	12	105	7	138
	Cancer	0	0	1	0	0	1	4	18	24
	Total	1	199	98	1	145	46	134	27	651

Table 21: Positive Percent Agreement and Negative Percent Agreement for Laboratory ThinPrep Genesis Diagnoses and Laboratory ThinPrep 2000 Diagnoses

In this table, Laboratory “Positive” means ASC-US+ or UNSAT, and Laboratory “Negative” means NILM.

Site	Positive Percent Agreement				Negative Percent Agreement			
	N	ThinPrep Genesis (95%CI)	ThinPrep 2000 (95%CI)	Difference (95%CI)	N	ThinPrep Genesis (95%CI)	ThinPrep 2000 (95%CI)	Difference (95%CI)
Site #1	220	76.8% (169/220) (70.8%; 81.9%)	75.5% (166/220) (69.4%; 80.7%)	1.4% (-3.5%; 6.3%)	192	96.4% (185/192) (92.7%; 98.2%)	94.8% (182/195) (90.7%; 97.1%)	1.6% (-1.9%; 5.4%)
Site #2	205	71.2% (146/205) (64.7%; 77.0%)	72.7% (149/205) (66.2%; 78.3%)	-1.5% (-5.8%; 2.8%)	212	93.4% (198/212) (89.2%; 96.0%)	92.0% (195/212) (87.5%; 94.9%)	1.4% (-2.9%; 5.8%)
Site #3	226	64.6% (146/226) (58.2%; 70.5%)	60.6% (137/226) (54.1%; 66.8%)	4.0% (-1.9%; 9.8%)	189	97.9% (185/189) (94.7%; 99.2%)	96.3% (182/189) (92.6%; 98.2%)	1.6% (-1.7%; 5.2%)
Combined	651	70.8% (61/651) (67.2%; 74.2%)	69.4% (452/651) (65.8%; 72.8%)	1.4% (-1.5%; 4.3%)	593	95.8% (568/593) (93.9%; 97.1%)	94.3% (559/593) (92.1%; 95.9%)	1.5% (-0.5%; 3.6%)

2. Reference Diagnosis LSIL+

In the study, there were 461 specimens with Reference Diagnosis of LSIL+ (combined LSIL, ASC-H, HSIL, and Cancer) and 783 specimens with Reference Diagnosis of (combined NILM, ASC-US/AGUS).

Table 22: Laboratory ThinPrep Genesis Results vs Laboratory ThinPrep 2000 Results for the Specimens with Reference Diagnosis of LSIL+

		Laboratory ThinPrep 2000								
		UNSAT	NILM	ASCUS	AGUS	LSIL	ASC-H	HSIL	Cancer	Total
Laboratory ThinPrep Genesis	UNSAT	0	0	0	0	1	0	1	0	2
	NILM	0	29	8	0	6	5	1	1	50
	ASCUS	0	15	38	0	18	7	2	0	80
	AGUS	0	1	0	1	0	0	1	0	3
	LSIL	0	7	10	0	105	2	7	0	131
	ASC-H	0	3	4	0	3	11	12	1	34
	HSIL	0	4	2	0	7	12	105	7	137
	Cancer	0	0	1	0	0	1	4	18	24
	Total	0	59	63	1	140	38	133	27	461

Table 23: Positive Percent Agreement and Negative Percent Agreement for Laboratory ThinPrep Genesis Diagnoses and Laboratory ThinPrep 2000 Diagnoses

In this table, Laboratory “Positive” means LSIL+ or UNSAT, and Laboratory “Negative” means NILM or ASC-US/AGUS.

Site	Positive Percent Agreement				Negative Percent Agreement			
	N	ThinPrep Genesis (95%CI)	ThinPrep 2000 (95%CI)	Difference (95%CI)	N	ThinPrep Genesis (95%CI)	ThinPrep 2000 (95%CI)	Difference (95%CI)
Site #1	162	74.7% (121/162) (67.5%; 80.8%)	76.5% (124/162) (69.5%; 82.4%)	-1.9% (-7.3%; 3.6%)	250	96.4% (241/250) (93.3%; 98.1%)	96.0% (240/250) (92.8%; 97.8%)	0.4% (-2.4%; 3.3%)
Site #2	138	81.9% (113/138) (74.6%; 87.4%)	84.8% (117/138) (77.9%; 89.8%)	-2.9% (-9.0%; 3.1%)	279	96.4% (269/279) (93.5%; 98.0%)	94.3% (263/279) (90.9%; 96.4%)	2.2% (-1.2%; 5.7%)
Site #3	161	58.4% (94/161) (50.7%; 65.7%)	60.2% (97/161) (52.5%; 67.5%)	-1.9% (-9.3%; 5.6%)	254	97.6% (248/254) (94.9%; 98.9%)	98.4% (250/254) (96.0%; 99.4%)	-0.8% (-3.2%; 1.3%)
Combined	461	71.1% (328/461) (66.9%; 75.1%)	73.3% (338/461) (69.1%; 77.2%)	-2.2% (-5.8%; 1.5%)	783	96.8% (758/783) (95.3%; 97.8%)	96.2% (753/783) (94.6%; 97.3%)	0.6% (-0.9%; 2.2%)

3. Reference Diagnosis ASC-H+

In the study, there were 246 specimens with Reference Diagnosis of ASC-H+ (combined ASC-H, HSIL, and Cancer) and 998 specimens with Reference Diagnosis of (combined NILM, ASC-US, AGUS, and LSIL).

Table 24: Laboratory ThinPrep Genesis Results vs Laboratory ThinPrep 2000 Results for the Specimens with Reference Diagnosis of ASC-H+.

		Laboratory ThinPrep 2000								
		UNSAT	NILM	ASCUS	AGUS	LSIL	ASC-H	HSIL	Cancer	Total
Laboratory ThinPrep Genesis	UNSAT	0	0	0	0	0	0	1	0	1
	NILM	0	12	2	0	0	5	1	1	21
	ASCUS	0	3	6	0	1	5	2	0	17
	AGUS	0	1	0	1	0	0	1	0	3
	LSIL	0	0	0	0	12	2	5	0	19
	ASC-H	0	3	4	0	1	9	12	1	30
	HSIL	0	3	2	0	5	11	103	7	131
	Cancer	0	0	1	0	0	1	4	18	24
	Total	0	22	15	1	19	33	129	27	246

Table 25: Positive Percent Agreement and Negative Percent Agreement for Laboratory ThinPrep Genesis Diagnoses and Laboratory ThinPrep 2000 Diagnoses

(In this table, Laboratory “Positive” means ASC-H+ or UNSAT, and Laboratory “Negative” means NILM or ASC-US/AGUS or LSIL)

Site	Positive Percent Agreement				Negative Percent Agreement			
	N	ThinPrep Genesis (95%CI)	ThinPrep 2000 (95%CI)	Difference (95%CI)	N	ThinPrep Genesis (95%CI)	ThinPrep 2000 (95%CI)	Difference (95%CI)
Site #1	89	82.0% (73/89) (72.8%; 88.6%)	84.3% (75/89) (75.3%; 90.4%)	-2.2% (-10.0%; 5.3%)	323	96.3% (311/323) (93.6%; 97.9%)	96.6% (312/323) (94.0%; 98.1%)	-0.3% (-2.5%; 1.9%)
Site #2	75	81.3% (61/75) (71.1%; 88.5%)	80.0% (60/75) (69.6%; 87.5%)	1.3% (-8.6%; 11.3%)	342	96.5% (330/342) (94.0%; 98.0%)	95.6% (327/342) (92.9%; 97.3%)	0.9% (-1.8%; 3.7%)
Site #3	82	63.4% (52/82) (52.6%; 73.0%)	65.9% (54/82) (55.1%; 75.2%)	-2.4% (-12.7%; 7.9%)	333	98.2% (327/333) (96.1%; 99.2%)	98.2% (327/333) (96.1%; 99.2%)	0.0% (-1.7%; 1.7%)
Combined	246	75.6% (186/246) (69.9%; 80.6%)	76.8% (189/246) (71.2%; 81.7%)	-1.2% (-6.4%; 4.0%)	998	97.0% (968/998) (95.7%; 97.9%)	96.8% (966/998) (95.5%; 97.7%)	0.2% (-1.0%; 1.4%)

4. Reference Diagnosis HSIL+

In the study, there were 208 specimens with Reference Diagnosis of HSIL+ (combined HSIL and Cancer) and 1036 specimens with Reference Diagnosis of (combined NILM, ASC-US, AGUS, LSIL, and ASC-H).

Table 26: Laboratory ThinPrep Genesis Results vs Laboratory ThinPrep 2000 Results for the Specimens with Reference Diagnosis of HSIL+

Laboratory ThinPrep 2000										
		UNSAT	NILM	ASCUS	AGUS	LSIL	ASC-H	HSIL	Cancer	Total
Laboratory ThinPrep Genesis	UNSAT	0	0	0	0	0	0	1	0	1
	NILM	0	0	0	0	0	2	1	1	4
	ASCUS	0	1	3	0	1	3	1	0	9
	AGUS	0	1	0	1	0	0	1	0	3
	LSIL	0	0	0	0	12	1	5	0	18
	ASC-H	0	3	3	0	1	8	9	0	24
	HSIL	0	2	2	0	5	11	99	7	126
	Cancer	0	0	1	0	0	1	3	18	23
	Total	0	7	9	1	19	26	120	26	208

Table 27: Positive Percent Agreement and Negative Percent Agreement for Laboratory ThinPrep Genesis Diagnoses and Laboratory ThinPrep 2000 Diagnoses

(In this table, Laboratory “Positive” means HSIL+ or UNSAT, and “Negative” means NILM or ASC-US/AGUS or LSIL or ASC-H.)

Site	Positive Percent Agreement				Negative Percent Agreement			
	N	ThinPrep Genesis (95%CI)	ThinPrep 2000 (95%CI)	Difference (95%CI)	N	ThinPrep Genesis (95%CI)	ThinPrep 2000 (95%CI)	Difference (95%CI)
Site #1	76	85.5% (65/76) (75.9%; 91.7%)	80.3% (61/76) (70.0%; 87.7%)	5.3% (-4.2%; 14.9%)	336	98.5% (331/336) (96.6%; 99.4%)	99.1% (333/336) (97.4%; 99.7%)	-0.6% (-2.4%; 1.0%)
Site #2	64	73.4% (47/64) (61.5%; 82.7%)	79.7% (51/64) (68.3%; 87.7%)	-6.3% (-18.0%; 5.6%)	353	97.5% (344/353) (95.2%; 98.7%)	96.0% (339/353) (93.5%; 97.6%)	1.4% (-0.9%; 3.9%)
Site #3	68	55.9% (38/68) (44.1%; 67.1%)	50.0% (34/68) (38.4%; 61.6%)	5.9% (-5.0%; 16.5%)	347	98.8% (343/347) (97.1%; 99.6%)	98.6% (342/347) (96.7%; 99.4%)	0.3% (-1.2%; 1.9%)
Combined	208	72.1% (150/208) (65.7%; 77.8%)	70.2% (146/208) (63.7%; 76.0%)	1.9% (-4.1%; 7.9%)	1036	98.3% (1018/1036) (97.3%; 98.9%)	97.9% (1014/1036) (96.8%; 98.6%)	0.4% (-0.6%; 1.4%)

5. Reference Diagnosis Cancer

In the study, there were 32 specimens with Reference Diagnosis of Cancer and 1212 specimens with Reference Diagnosis of (combined NILM, ASC-US, AGUS, LSIL, ASC-H, and HSIL).

Table 28: Laboratory ThinPrep Genesis Results vs Laboratory ThinPrep 2000 results for the Specimens with Reference Diagnosis of Cancer.

		Laboratory ThinPrep 2000								
		UNSAT	NILM	ASCUS	AGUS	LSIL	ASC-H	HSIL	Cancer	Total
Laboratory ThinPrep Genesis	UNSAT	0	0	0	0	0	0	0	0	0
	NILM	0	0	0	0	0	0	0	1	1
	ASCUS	0	0	0	0	0	0	0	0	0
	AGUS	0	1	0	0	0	0	1	0	2
	LSIL	0	0	0	0	1	0	0	0	1
	ASC-H	0	0	0	0	0	1	0	0	1
	HSIL	0	0	0	0	0	1	3	4	8
	Cancer	0	0	1	0	0	0	1	17	19
Total		0	1	1	0	1	2	5	22	32

Table 29: Positive Percent Agreement and Negative Percent Agreement for Laboratory ThinPrep Genesis Diagnoses and Laboratory ThinPrep 2000 Diagnoses

(In this table, Laboratory “Positive” means Cancer or UNSAT, and “Negative” means NILM or ASC-US/AGUS or LSIL or ASC-H or HSIL).

Site	Positive Percent Agreement				Negative Percent Agreement			
	N	ThinPrep Genesis (95%CI)	ThinPrep 2000 (95%CI)	Difference (95%CI)	N	ThinPrep Genesis (95%CI)	ThinPrep 2000 (95%CI)	Difference (95%CI)
Site #1	14	78.6% (11/14) (52.4%; 92.4%)	78.6% (11/14) (52.4%; 92.4%)	0.0% (-24.8%; 24.8%)	398	99.5% (396/398) (98.2%;99.9%)	99.7% (397/398) (98.6%;100.0%)	-0.3% (-1.5%;0.8%)
Site #2	7	71.4% (5/7) (35.9%; 91.8%)	100.0% (7/7) (64.6%; 100%)	-28.6% (-64.1%; 12.3%)	410	98.5% (404/410) (96.8%; 99.3%)	98.5% (404/410) (96.8%; 99.3%)	0.0% (-1.9%; 1.9%)
Site #3	11	27.3% (3/11) (9.7%; 56.6%)	36.4% (4/11) (15.2%; 64.6%)	-9.1% (-39.6%; 24.0%)	404	99.3% (401/404) (97.8%; 99.7%)	99.3% (401/404) (97.8%; 99.7%)	0.0% (-1.2%; 1.2%)
Combined	32	59.4% (19/32) (42.3%; 74.5%)	68.8% (22/32) (51.4%; 82.0%)	-9.4% (-25.3%; 7.4%)	1212	99.1% (1201/1212) (98.4%; 99.5%)	99.2% (1202/1212) (98.5%; 99.6%)	-0.1% (-0.8%;0.6%)

Results of the clinical study for 32 specimens with Reference Diagnosis of Cancer were analyzed where “Positive” means HSIL+ (combined Cancer and HSIL).

Both the ThinPrep Genesis processor and the ThinPrep 2000 system have HSIL+ results for 27 out of 32 specimens (PPAs for both are 84.4% (27/32) and difference is 0.0% with 95%CI: (-14.9%; 14.9%)).

Both the ThinPrep Genesis processor and the ThinPrep 2000 system have ASC-US+ results for 31 out of 32 specimens (PPAs for both are 96.9% (31/32) and difference is 0.0% with 95%CI: (-14.2%; 14.2%)). Table 30 provides additional details on one specimen with NILM adjudicated result on the ThinPrep Genesis slide and with Cancer adjudicated result on the ThinPrep 2000 slide.

Table 30: Laboratory and Adjudicated Diagnoses of Specimen with NILM Adjudicated Result on Slide Prepared on ThinPrep Genesis Processor and Cancer Result on Slide Prepared with the ThinPrep 2000 System

	Slide	Diagnoses from slide prepared on TP-2000 (second slide)	Diagnoses from slide prepared on ThinPrep Genesis (first slide)
Lab- oratory	Manual 1	CANCER	CANCER
	Manual 2	CANCER	CANCER
	Manual 3	CANCER	CANCER
Adjudicated	Adjudicated result 1	CANCER	NILM
	Adjudicated result 2	CANCER	NILM

	Adjudicated result 3	AGUS	NILM
	Final Adjudicated result	CANCER	NILM

Results of the clinical study for 20 specimens with Reference Diagnosis of Adenocarcinoma are also presented in Table 31.

Table 31: Adjudicated Results for 32 Specimens with Reference Diagnosis of Cancer

		ThinPrep 2000 Adjudicated Results											
		NILM	ASC-US	ASC-H	HSIL	SCC	AGC-NOS	AGC favor neo	AIS	Adeno-NOS	Adeno-EC	Adeno-EM	Total
ThinPrep Genesis Adjudicated Results	NILM							1					1
	ASC-US							1					1
	ASC-H					1							1
	HSIL					3		1	1		1		6
	SCC			2	1	4							7
	AGC-NOS					1							1
	AGS favor neo							1					1
	AIS				2					1			3
	Adeno-NOS										1		1
	Adeno-EC				1								1
	Adeno-EM							1			1	7	9
Total				2	4	9	2	3	2	1	2	7	32

Among 32 specimens with Reference Diagnosis of Cancer, there were 20 specimens with Reference Diagnosis of Adenocarcinoma. Both the ThinPrep Genesis processor and the ThinPrep 2000 system have adjudicated results of Adenocarcinoma for 75% (15/20) specimens.

6. UNSAT Slides by Adjudication Panels

Tables 32 and 33 provide details on the various levels of agreement among the CT and pathologist pairs for the specimens determined to be unsatisfactory for evaluation by the adjudication panels. The tables also indicate if a specimen was first run on the ThinPrep Genesis processor, or if was first run on the ThinPrep 2000 System. In the study, there were 0.4% (5 out of 1253) UNSAT ThinPrep Genesis slides and 0.5% (6 out of 1253) UNSAT ThinPrep 2000 slides.

Table 32: UNSAT Specimen Details, ThinPrep Genesis Slides

UNSAT Genesis slides	Processing Order from Vial	Manual Diagnosis by CT/Path#1	Manual Diagnosis by CT/Path#2	Manual Diagnosis by CT/Path#3	Reason for adj. UNSAT result
Genesis sample 1	First	ASCUS	NILM	NILM	Hypocellular
Genesis sample 2	First	HSIL	HSIL	HSIL	Hypocellular
Genesis sample 3	Second	NILM	NILM	NILM	Hypocellular, Obscuring inflammation
Genesis sample 4	First	NILM	NILM	NILM	Obscuring inflammation (UNSAT on multihead)
Genesis sample 5	Second	UNSAT	NILM	NILM	Hypocellular, Bloody
Sensitivity (95%)		60.0% (3/5) (23.1%; 88.2%)	20.0% (1/5) (3.6%; 62.5%)	20.0% (1/5) (3.6% ; 62.5%)	

The positive percent agreement averaged over 3 pairs of CT/Pathologist for ThinPrep Genesis UNSAT slides was 33.3%.

Table 33: UNSAT Specimen Details, ThinPrep 2000 Slides

UNSAT TP-2000 slides	Processing Order from Vial	Manual Diagnosis by CT/Path#1	Manual Diagnosis by CT/Path#2	Manual Diagnosis by CT/Path#3	Reason for adj. UNSAT result
TP-2000 sample 1	First	UNSAT	NILM	NILM	Hypocellular
TP-2000 sample 2	Second	UNSAT	UNSAT	UNSAT	Hypocellular
TP-2000 sample 3	First	UNSAT	NILM	UNSAT	Hypocellular
TP-2000 sample 4	Second	NILM	NILM	NILM	Hypocellular, Obscuring inflammation
TP-2000 sample 5	Second	UNSAT	NILM	NILM	Hypocellular
TP-2000 sample 6	First	UNSAT	NILM	UNSAT	Hypocellular
Sensitivity (95% score CI)		83.3% (5/6) (43.7%; 97.0%)	16.7% (1/6) (3.0%; 56.4%)	50.0% (3/6) (18.8%; 81.2%)	

The positive percent agreement averaged over 3 pairs of CT/Pathologist for ThinPrep 2000 UNSAT slides was 50.0%.

Precision Studies

Within-instrument precision and between-instrument precision (reproducibility) of the ThinPrep Genesis processor was evaluated in laboratory studies using a split-sample technique.

WITHIN-INSTRUMENT PRECISION

A total of 160 specimens were enrolled in the study. Each specimen was split into three portions and processed on three separate runs on a single instrument using “Slide Only” process. The slides were stained, coverslipped, and then reviewed by cytotechnologists according to the Bethesda System for Reporting Cervical Cytology. Seven specimens were excluded from the analysis because at least one slide was unavailable for CT review. The resulting diagnoses are summarized in Table 36 with comparisons of the different runs in Tables 37, 38, and 39.

Table 36: Within-Instrument Precision

Sample processing run on the ThinPrep Genesis processor	Specimen Diagnostic Level			
	NILM	ASCUS or AGUS	LSIL	ASC-H or HSIL or Cancer
Run 1 (n = 153)	109	12	18	14
Run 2 (n = 153)	111	11	16	15
Run 3 (n = 153)	109	11	19	14
	Number of specimens with three matching replicates			
	107	9	16	14

Percent of specimens with 3 matching replicates was 95.4% (146/153), 95%CI: (90.9%; 97.8%)

Table 37: Run-to-Run Precision: Run 1 vs Run 2

Run 2	Run 1						
	UNSAT	NILM	ASCUS/AGUS	LSIL	ASC-H	HSIL	Cancer
UNSAT	0	0	0	0	0	0	0
NILM	0	107	2	2	0	0	0
ASCUS/AGUS	0	1	10	0	0	0	0
LSIL	0	0	0	16	0	0	0
ASC-H	0	0	0	0	1	0	0
HSIL	0	1	0	0	0	13	0
Cancer	0	0	0	0	0	0	0

Table 38: Run-to-Run Precision: Run 1 vs Run 3

Run 3	Run 1						
	UNSAT	NILM	ASCUS/ AGUS	LSIL	ASC-H	HSIL	Cancer
UNSAT	0	0	0	0	0	0	0
NILM	0	107	2	0	0	0	0
ASCUS/AGUS	0	1	10	0	0	0	0
LSIL	0	0	0	18	0	1	0
ASC-H	0	0	0	0	1	0	0
HSIL	0	1	0	0	0	12	0
Cancer	0	0	0	0	0	0	0

Table 39: Run-to-Run Precision: Run 2 vs Run 3

Run 3	Run 2						
	UNSAT	NILM	ASCUS/ AGUS	LSIL	ASC-H	HSIL	Cancer
UNSAT	0	0	0	0	0	0	0
NILM	0	107	2	0	0	0	0
ASCUS/AGUS	0	2	9	0	0	0	0
LSIL	0	3	0	16	0	1	0
ASC-H	0	0	0	0	1	0	0
HSIL	0	0	0	0	0	13	0
Cancer	0	0	0	0	0	0	0

BETWEEN-INSTRUMENT REPRODUCIBILITY

A total of 160 specimens were enrolled in the study. Each specimen was split into three portions and processed on three different ThinPrep Genesis processors using “Slide Only” process. The slides were stained, coverslipped, and then reviewed by cytotechnologists using Imager-assisted review according to the Bethesda System for Reporting Cervical Cytology. Ten specimens were excluded because at least one slide was unavailable for CT review. The resulting diagnoses are presented in Table 40, with comparisons of the different runs in Tables 41, 42, and 43.

Table 40: Between-Instrument Reproducibility

ThinPrep Genesis Processor	Specimen Diagnostic Level Number of specimens with three matching replicates			
	NILM	ASCUS or AGUS	LSIL	ASC-H or HSIL or Cancer
ThinPrep Genesis Instrument 1 (n = 150)	112	2	22	14
ThinPrep Genesis Instrument 2 (n = 150)	109	3	23	15
ThinPrep Genesis Instrument 3 (n = 150)	111	2	21	16
	Number of specimens with three matching replicates			
	104	0	18	9

Percent of specimens with 3 matching replicates was 87.3% (131/150), 95%CI: (81.1%; 91.7%)

**Table 41: Instrument-to-Instrument Reproducibility,
ThinPrep Genesis Instrument 1 versus ThinPrep Genesis Instrument 2**

ThinPrep Genesis Instrument 2	ThinPrep Genesis Instrument 1						
	UNSAT	NILM	ASCUS/AGUS	LSIL	ASC-H	HSIL	Cancer
UNSAT	0	0	0	0	0	0	0
NILM	0	105	1	3	0	0	0
ASCUS/AGUS	0	2	1	0	0	0	0
LSIL	0	3	0	18	1	1	0
ASC-H	0	1	0	0	1	1	0
HSIL	0	1	0	1	1	8	0
Cancer	0	0	0	0	0	0	1

**Table 42: Instrument-to-Instrument Reproducibility,
ThinPrep Genesis Instrument 1 versus ThinPrep Genesis Instrument 3**

ThinPrep Genesis Instrument 3	ThinPrep Genesis Instrument 1						
	UNSAT	NILM	ASCUS/AGUS	LSIL	ASC-H	HSIL	Cancer
UNSAT	0	0	0	0	0	0	0
NILM	0	108	1	2	0	0	0
ASCUS/AGUS	0	1	0	1	0	0	0
LSIL	0	1	0	18	1	1	0
ASC-H	0	2	1	0	0	1	0
HSIL	0	0	0	1	2	8	0
Cancer	0	0	0	0	0	0	1

**Table 43: Instrument-to-Instrument Reproducibility,
ThinPrep Genesis Instrument 2 versus ThinPrep Genesis Instrument 3**

ThinPrep Genesis Instrument 3	ThinPrep Genesis Instrument 2						
	UNSAT	NILM	ASCUS/AGUS	LSIL	ASC-H	HSIL	Cancer
UNSAT	0	0	0	0	0	0	0
NILM	0	104	2	4	0	1	0
ASCUS/AGUS	0	2	0	0	0	0	0
LSIL	0	2	0	18	0	1	0
ASC-H	0	1	1	0	2	0	0
HSIL	0	0	0	1	1	9	0
Cancer	0	0	0	0	0	0	1

Cell Count Study

A study was conducted to evaluate the quantity of cellular material transferred onto slides, comparing the ThinPrep Genesis processor to the ThinPrep 2000 system.

Two comparisons were made. Slides prepared on the ThinPrep Genesis processor using the “Aliquot + Slide” process were compared to slides prepared on the ThinPrep 2000 system. And, slides prepared on the ThinPrep Genesis processor using the “Slide Only” process were compared to slides prepared using the ThinPrep 2000 system.

A split-sample technique was used. A total of 300 specimens were enrolled in the study. Each specimen was split into three portions. Specimens processed by one of three methods (ThinPrep 2000, ThinPrep Genesis “Aliquot + Slide” or ThinPrep Genesis “Slide”). The slides were stained, coverslipped, and then imaged with the ThinPrep Imaging System in order to quantify the amount of cellular material on each slide. Furthermore, the slides prepared in the cell count study were reviewed by cytotechnologists and categorized according to the Bethesda System for Reporting Cervical Cytology.

Results of the Study: ThinPrep Genesis “Slide Only” Process vs. ThinPrep 2000 System

Figure 1 presents a scatter plot of cell counts and an ordinary Deming linear regression analysis.

Figure 1: ThinPrep Genesis “Slide” Process vs. ThinPrep 2000 System

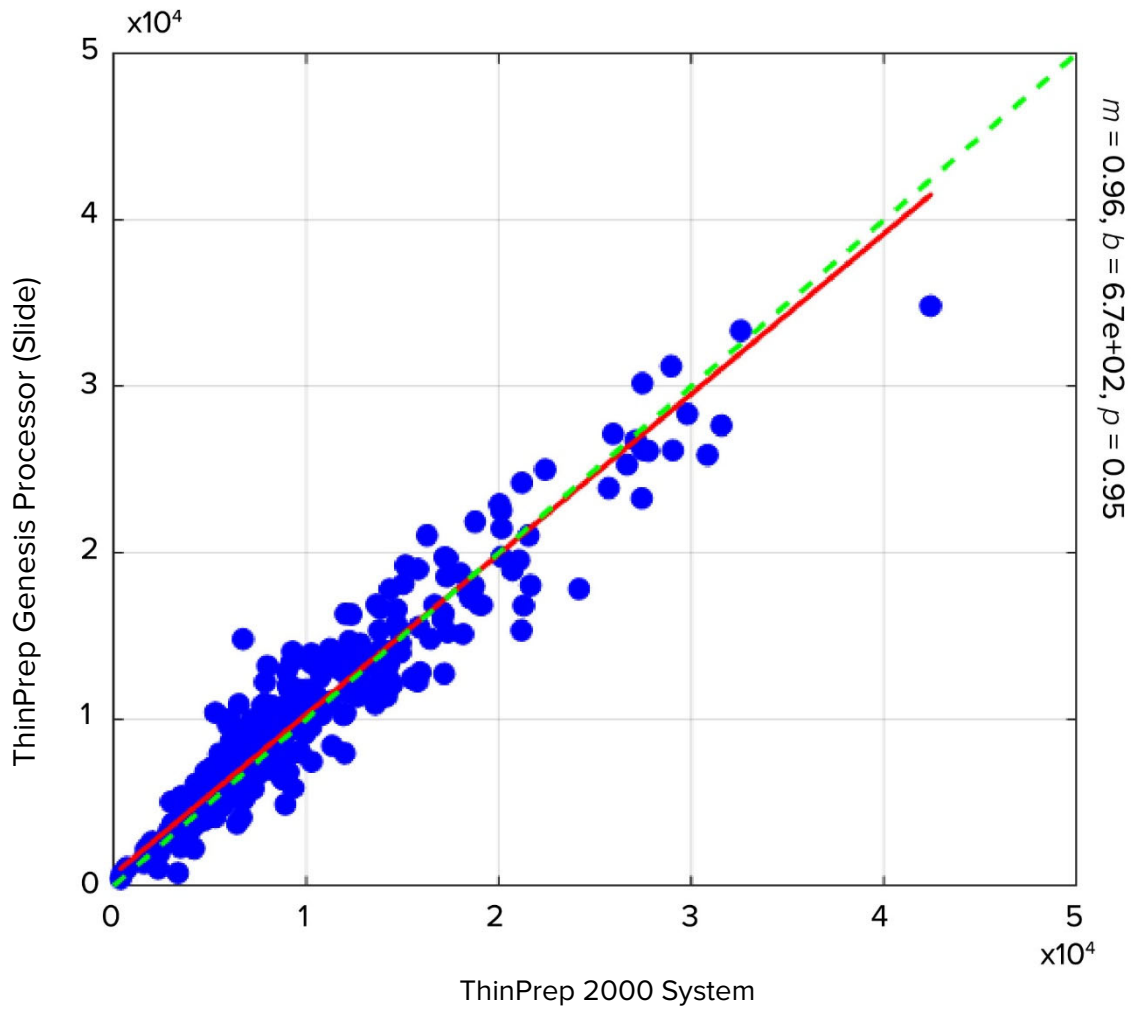

Deming regression analysis was performed, and the slope was 0.96 with 95%CI: (0.94; 0.99) and the intercept was 670 with 95% CI: (420; 930)

The resulting diagnosis determinates are presented in Table 44.

Table 44: Diagnostic Comparison of Slides Processed on the ThinPrep Genesis Processor (“Slide Only” Process) vs. ThinPrep 2000 System

		ThinPrep 2000 System		
		<i>UNSAT</i>	<i>ASCUS+</i>	<i>NILM</i>
ThinPrep Genesis Processor (“Slide Only” process)	<i>UNSAT</i>	10	0	1
	<i>ASCUS+</i>	0	66	13
	<i>NILM</i>	3	12	195

Percent of UNSAT slides were 3.7% (11/300) for ThinPrep Genesis Processor (“Slide” process) and 4.3% (13/300) for ThinPrep 2000 system; difference was -0.7%, 95%CI: (-2.6%; 1.1%). Percent for ASC-US+ slides were 27.6% (79/286) for ThinPrep Genesis Processor (“Slide Only” process) and 27.3% (78/286) for ThinPrep 2000 system; difference was 0.3% with 95%CI: (-3.2%; 3.9%).

The data demonstrate similar cell count values on the ThinPrep Genesis processor (“Slide Only” process) and ThinPrep 2000 system.

Results of the Study: ThinPrep Genesis “Aliquot+Slide” Process vs. ThinPrep 2000 System

Figure 2 presents a scatter plot of cell counts and an ordinary Deming linear regression analysis.

Figure 2: ThinPrep Genesis “Aliquot + Slide” Process vs. ThinPrep 2000 System

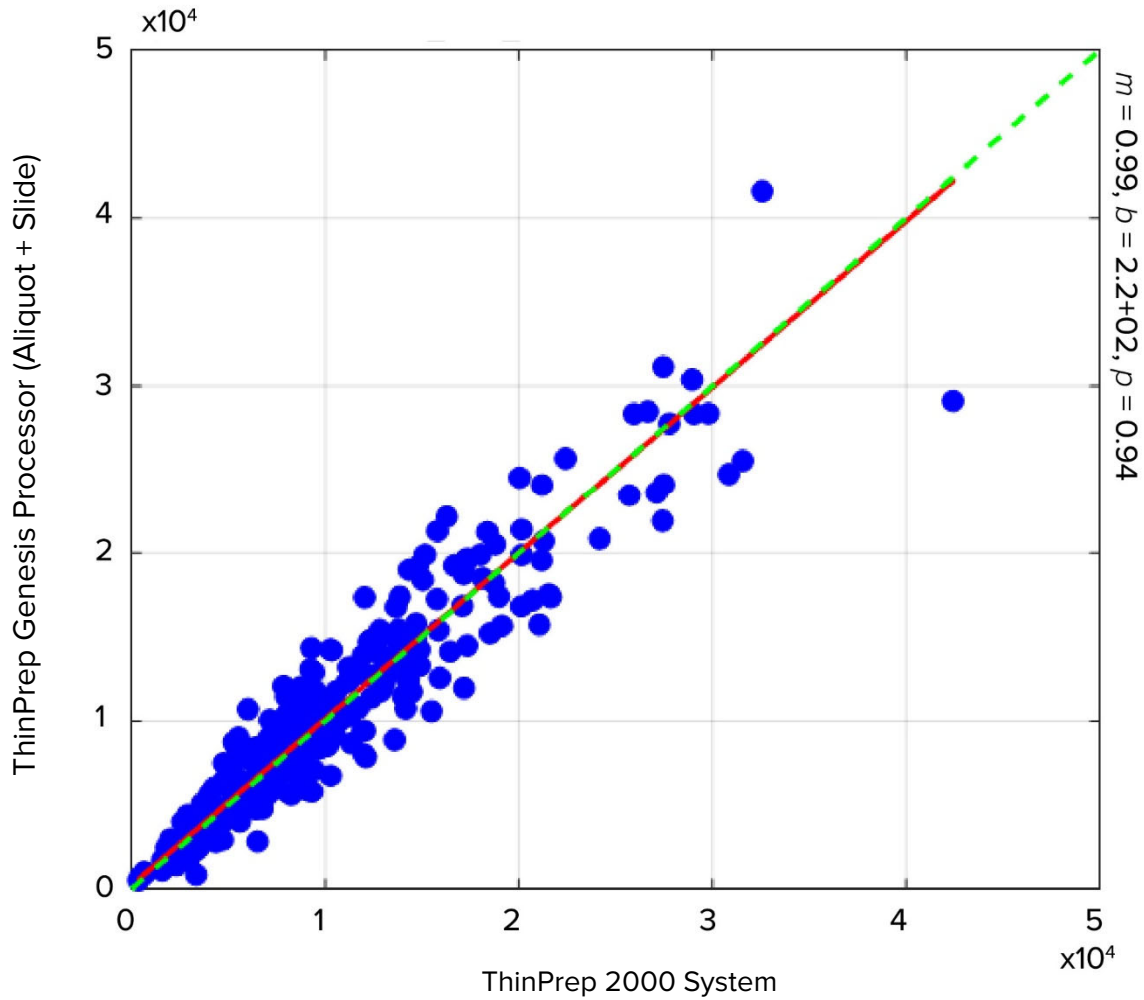

Deming regression analysis was performed and the slope was 0.99 with 95%CI: (0.96; 1.02) and the intercept was 220 with 95%CI: (-70;500)

The resulting diagnosis determinates are presented in Table 45.

Table 45: Diagnostic Comparison of Slides Processed on the ThinPrep Genesis Processor (Aliquot + Slide Process) vs. ThinPrep 2000 System

		ThinPrep 2000 System		
		<i>UNSAT</i>	<i>ASCUS+</i>	<i>NILM</i>
ThinPrep Genesis Processor ("Aliquot + Slide" process)	<i>UNSAT</i>	9	0	2
	<i>ASCUS+</i>	0	70	15
	<i>NILM</i>	4	8	192

Percent of UNSAT slides were 3.7% (11/300) for ThinPrep Genesis Processor ("Aliquot+ Slide" process) and 4.3% (13/300) for ThinPrep 2000 system; difference was -0.7%, 95%CI: (-2.8%; 1.3%). Percent for ASC-US+ slides were 29.7% (85/286) for ThinPrep Genesis Processor ("Aliquot+Slide" process) and 27.4% (78/286) for ThinPrep 2000 system; difference was 2.5% with 95%CI: (-0.9%; 5.8%).

The data demonstrate similar cell count values on the ThinPrep Genesis processor ("Aliquot+ Slide" process) and ThinPrep 2000 system.

Carry-Over Study

Cellular carry-over between slides was evaluated in a study for the ThinPrep Genesis processor and the ThinPrep 2000 system.

On each system 350 abnormal clinical specimens were processed, alternating with 350 PreservCyt vials containing no cells ("acellular vials"). Specimens processed on the ThinPrep Genesis processor used the "Aliquot + Slide" process. After processing, slides made from the acellular vials were segregated from the cellular slides, stained and coverslipped and then reviewed by cytotechnologists. Any cells found on a slide were noted. Slides made from an acellular vial but containing at least one cell were considered to have cellular carry-over. One slide from the ThinPrep 2000 system was excluded due to operator error. Table 46 presents the results.

Table 46: Cellular Carry-Over

	ThinPrep 2000 System	ThinPrep Genesis Processor ("Aliquot+Slide" process)
Total # of Slides	349	350
# of Slides with carry-over	89	20
% of Slides with carry-over	25.5%	5.7%
Number of cells on the slides with carry-over: Median (Min, Max)	2 (1, 96)	2 (1, 43)

The study demonstrated that the cellular cross-contamination from slide to slide on the ThinPrep Genesis is not inferior to the cross-contamination on the ThinPrep 2000 system.

Aliquot Delivery Study

The ability for the ThinPrep Genesis processor to dispense an aliquot from a ThinPrep vial into an output tube was evaluated in a laboratory study. The data generated for this study demonstrate that the ThinPrep Genesis processor dispenses 1 mL ± 4% from the ThinPrep vial to an output tube.

Conclusions

The results of the study comparing the performance of the ThinPrep Genesis processor to the ThinPrep 2000 system demonstrate that the ThinPrep Genesis processor is at least as effective as the ThinPrep 2000 system for preparing slides from gynecologic specimens for the detection of atypical cells, cervical cancer including adenocarcinoma or its precursor lesions, as well as all other cytologic categories as defined by *The Bethesda System for Reporting Cervical Cytology*.

The ThinPrep® 2000 system is as effective as the conventional Pap smear in a variety of patient populations and may be used as a replacement for the conventional Pap smear method for the detection of atypical cells, cervical cancer, or its precursor lesions, as well as all other cytologic categories as defined by The Bethesda System. Since the ThinPrep Genesis processor uses similar cell collection and slide preparation technology as the ThinPrep 2000 system, the ThinPrep Genesis processor is also as effective as the conventional Pap smear in a variety of patient populations and may be used as a replacement for the conventional Pap smear method for the detection of atypical cells, cervical cancer, or its precursor lesions, as well as all other cytologic categories as defined by the Bethesda System.

The ThinPrep 2000 system is significantly more effective than the conventional Pap smear for the detection of Low-grade Squamous Intraepithelial (LSIL) and more severe lesions in a variety of patient populations. Since the ThinPrep Genesis processor uses similar cell collection and slide preparation technology as the ThinPrep 2000 system, the ThinPrep Genesis processor is also significantly more effective than the conventional Pap smear for the detection of Low-grade Squamous Intraepithelial (LSIL) and more severe lesions in a variety of patient populations.

Specimen quality with the ThinPrep 2000 system is significantly improved over that of conventional Pap smear preparation in a variety of patient populations. Since the ThinPrep Genesis processor uses similar cell collection and slide preparation technology as the ThinPrep 2000 system, the specimen quality with the ThinPrep Genesis processor is also significantly improved over that of conventional Pap smear preparation in a variety of patient populations.

MATERIALS REQUIRED

MATERIALS PROVIDED

- ThinPrep Genesis processor
- ThinPrep Genesis processor operator's manual
- Power cord
- Waste bottle assembly with tubing harness and transport cover
- Fixative baths (10)
- Pipette tip disposal cup (2)
- Absorbent pad for filter plug (4)
- Absorbent pad for filter puncture area (4)
- Pipette tip holder (2, for customers performing aliquot removal)
- Multi-channel pipette tip gripper (for customers performing aliquot removal)
- Slide printer (optional)
- Tube printer (optional)
- USB key (1)

MATERIALS REQUIRED BUT NOT PROVIDED

- 20 ml PreservCyt® Solution vial
- ThinPrep® Pap Test filter
- ThinPrep® microscope slide
- Pipette tips (conductive, disposable, plastic pipette tips with an aerosol-resistant filter, 1 mL, for customers performing aliquot removal)
- Specimen transfer tube (for customers performing aliquot removal)
- Cervical collection device
- Slide staining system and reagents
- Standard laboratory fixative
- Coverslips and mounting media

- Lint-free wipes
- Personal protective equipment
- Sodium hypochlorite solution (0.5% solution, for customers performing aliquot removal)

STORAGE

- Store PreservCyt Solution between 15°C (59°F) and 30°C (86°F). Do not use beyond the expiration date printed on the container.
- Store PreservCyt Solution with cytologic sample intended for ThinPrep Pap testing between 15°C (59°F) and 30°C (86°F) for up to 6 weeks.

BIBLIOGRAPHY

1. Nayar R, Wilbur DC. (eds), *The Bethesda System for Reporting Cervical Cytology: Definitions, Criteria, and Explanatory Notes*. 3rd ed. Cham, Switzerland: Springer: 2015
2. Jones HW. Impact of The Bethesda System, *Cancer* 77 pp. 1914-1918, 1995.
3. American Cancer Society. *Cancer Facts and Figures*, 1995.
4. Ashfaq R, Gibbons D, Vela C, Saboorian MH, Iliya F. ThinPrep Pap Test. Accuracy for glandular disease. *Acta Cytol* 1999; 43: 81-5
5. Bai H, Sung CJ, Steinhoff MM: ThinPrep Pap Test promotes detection of glandular lesions of the endocervix. *Diagn Cytopathol* 2000;23:19-22
6. Carpenter AB, Davey DD: ThinPrep Pap Test: Performance and biopsy follow-up un a university hospital. *Cancer Cytopathology* 1999; 87: 105-12
7. Guidos BJ, Selvaggi SM. Detection of endometrial adenocarcinoma with the ThinPrep Pap test. *Diagn Cytopathol* 2000; 23: 260-5
8. Schorge JO, Hossein Saboorian M, Hynan L, Ashfaq R. ThinPrep detection of cervical and endometrial adenocarcinoma: A retrospective cohort study. *Cancer Cytopathology* 2002; 96: 338-43
9. Wang N, Emancipator SN, Rose P, Rodriguez M, Abdul-Karim FW. Histologic follow-up of atypical endocervical cells. Liquid-based, thin-layer preparation vs. conventional Pap smear. *Acta Cytol* 2002; 46: 453-7

TECHNICAL SERVICE AND PRODUCT INFORMATION

For technical service and assistance related to use of the ThinPrep Genesis processor, contact Hologic:

Telephone: 1-800-442-9892

Fax: 1-508-229-2795

For international or toll-free blocked calls, please contact 1-508-263-2900.

Email: info@hologic.com



Hologic, Inc.
250 Campus Drive
Marlborough, MA 01752
1-800-442-9892
www.hologic.com

©2022 Hologic, Inc. All rights reserved.

Table of Contents

Table of Contents



Table of Contents

Chapter One

Introduction

SECTION A: Overview and Function of the ThinPrep® Genesis Processor	1.1
SECTION B: Principles of Operation	1.8
SECTION C: ThinPrep Genesis Processor Technical Specifications.....	1.14
SECTION D: Internal Quality Control	1.20
SECTION E: ThinPrep Genesis Processor Hazards	1.20
SECTION F: Disposal	1.26

Chapter Two

Installation

SECTION A: General	2.1
SECTION B: Action Upon Delivery	2.1
SECTION C: Preparation Prior to Installation	2.2
SECTION D: Storage and Handling - Post-Installation	2.5
SECTION E: Turn on the ThinPrep Genesis System	2.6
SECTION F: Set User Preferences.....	2.7
SECTION G: Turn Off the ThinPrep Genesis System.....	2.7

Chapter Three

PreservCyt® and Cytolyt® Solutions

SECTION A: PreservCyt® and CytoLyt® Solutions	3.1
SECTION B: CytoLyt® Solution	3.5

Chapter Four

Gynecologic Sample Preparation

SECTION A: Introduction	4.1
SECTION B: Collection Preparation.....	4.2
SECTION C: Specimen Collection	4.4
SECTION D: Special Precautions	4.7



TABLE OF CONTENTS

SECTION E: Specimen Processing.....	4.8
SECTION F: Sample Processing Troubleshooting.....	4.9
<i>Chapter Five</i>	
NON-Gynecologic Sample Preparation	
SECTION A: Introduction	5.1
SECTION B: Contents.....	5.2
SECTION C: Required Materials.....	5.3
SECTION D: Details of Non-Gynecologic Sample Preparation Steps	5.4
SECTION E: Specimen Preparation Recommendations.....	5.16
SECTION F: Urine Specimens for the Vysis™ Urovysion Assay.....	5.22
SECTION G: Sample Preparation Troubleshooting.....	5.24
<i>Chapter Six</i>	
USER INTERFACE	
SECTION A: Screen Display	6.2
SECTION B: Main Menu, Processor Idle	6.3
SECTION C: Administrative Options	6.9
<i>Chapter Seven</i>	
Operating Instructions	
SECTION A: Introduction	7.1
SECTION B: Optional Instructions for Ancillary Testing	7.2
SECTION C: Material Requirements.....	7.4
SECTION D: Label the Sample Vials, Slides and Tubes.....	7.8
SECTION E: Open or Close the Door.....	7.11
SECTION F: Using the Tube Printer.....	7.13
SECTION G: Using the Slide Printer	7.15
SECTION H: Load the Fixative Bath.....	7.18
SECTION I: Load the Pipette Tips	7.19
SECTION J: Pre-Operation Checklist.....	7.21
SECTION K: Select the Process and Begin Processing	7.21
SECTION L: Process a Slide on the ThinPrep Genesis Processor	7.23



SECTION M: Remove an Aliquot from the Sample Vial on the ThinPrep Genesis Processor.....7.33

SECTION N: Remove an Aliquot from the Sample Vial and Process a Slide on the ThinPrep Genesis Processor.....7.37

SECTION O: Cancel Sample Processing.....7.47

Chapter Eight

Maintenance

SECTION A: Daily8.3

SECTION B: Weekly Cleaning8.4

SECTION C: As Needed Cleaning and Maintenance8.13

SECTION D: Moving the ThinPrep® Genesis Processor8.24

SECTION E: Replacing the User Accessible Fuses.....8.26

SECTION F: Replacing the Slide Printer8.28

SECTION G: Replacing the Tube Printer8.29

Chapter Nine

Troubleshooting

SECTION A: General9.1

SECTION B: Sample Processing Errors.....9.1

SECTION C: Media Handling Errors9.11

SECTION D: System Errors.....9.13

Chapter Ten

Fixation, Staining, and Coverslipping

SECTION A: Introduction10.1

SECTION B: Fixation10.2

SECTION C: Staining.....10.3

SECTION D: Coverslipping10.6

Chapter Eleven

ThinPrep Pap Test Training Program

Service Information

Ordering Information

Index



TABLE OF CONTENTS

This page intentionally left blank.

Chapter One

Introduction

This chapter describes an overview and the principles of operation of the ThinPrep® Genesis™ System.

SECTION A

OVERVIEW AND FUNCTION OF THE THINPREP® GENESIS PROCESSOR

The ThinPrep Genesis System is used to process liquid-based cytologic specimens to produce a thin, uniform preparation of cells that is transferred and fixed onto a glass microscope slide. The slide is delivered directly into a cup containing an alcohol fixative bath. After processing, the slide is ready for staining, coverslipping and screening. The processor supports the preparation of:

- slides prepared from gynecologic specimens for use with the ThinPrep Pap test, and subsequent imaging by the ThinPrep Imaging System.
- slides prepared from non-gynecologic specimens collected for general cytologic screening.
- slides prepared from urine specimens, including specimens used in conjunction with the Vysis™ UroVysion assay.

One slide per vial may be processed at a time.

The ThinPrep Genesis System can also be used to remove an aliquot from a specimen preserved in PreservCyt® Solution into an Aptima® specimen transfer tube. And, the ThinPrep Genesis System can conduct the aliquot removal process and the slide preparation process from the same specimen.

Indication for Use

Intended use

The ThinPrep® Genesis™ processor is an integral part of the ThinPrep® system. The ThinPrep® Genesis processor is used to prepare ThinPrep® microscope slides from ThinPrep® PreserCyt® vials to screen for the presence of atypical cells, cervical cancer, or its precursor lesions (Lowgrade Squamous intraepithelial Lesions, High-grade Squamous Intraepithelial Lesions), as well as all other cytologic categories, including adenocarcinoma, as defined by *The Bethesda System for Reporting Cervical Cytology*¹.

1. Nayar R, Wilbur DC. (eds). *The Bethesda System for Reporting Cervical Cytology: Definitions, Criteria, and Explanatory Notes*. 3rd ed. Cham, Switzerland: Springer: 2015

1 INTRODUCTION

The ThinPrep Genesis processor is also used to prepare ThinPrep slides from non-gynecological (non-gyn) samples, including urine samples, and it can be used to pipette an aliquot from the sample vial to a specimen transfer tube. For professional use only.

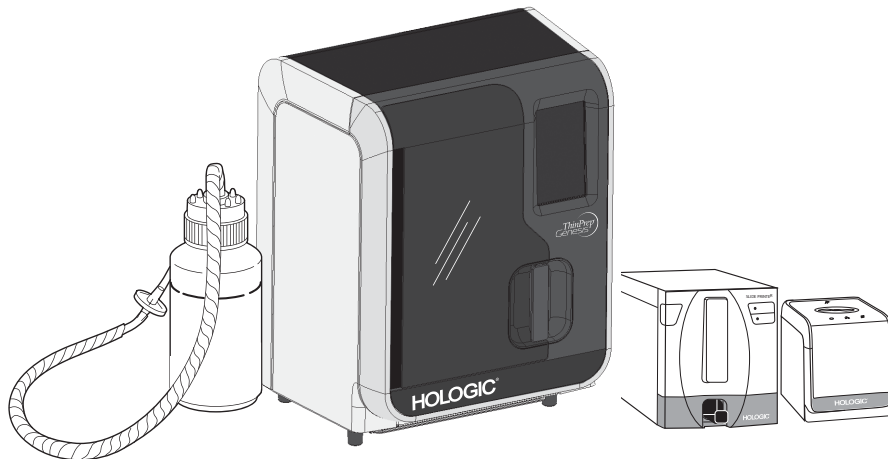

Figure 1-1 The ThinPrep Genesis system, shown with optional printers

The ThinPrep® Pap Test

The ThinPrep Pap test is a fluid-based method for the collection and preparation of gynecologic samples.

The ThinPrep process begins with the patient's gynecologic sample being collected by the clinician using a cervical sampling device which, rather than being smeared on a microscope slide, is immersed and rinsed in a vial filled with PreservCyt® Solution. The ThinPrep sample vial is then capped, labeled, and sent to a laboratory equipped with a ThinPrep Genesis processor.

At the laboratory, the PreservCyt sample vial is placed into a ThinPrep Genesis processor and a gentle dispersion step breaks up blood, mucus, non-diagnostic debris, and thoroughly mixes the cell sample. The cells are then collected on a ThinPrep Pap test filter specifically designed to collect diagnostic cells. The ThinPrep Genesis processor constantly monitors the rate of flow through the ThinPrep Pap test filter during the collection process in order to prevent the cellular presentation from being too scant or too dense. A thin layer of cells is then transferred to a glass slide. The slide is then automatically deposited into a fixative solution.

In addition to preparing a slide from a PreservCyt sample vial, the ThinPrep Genesis processor has the ability remove a 1-ml aliquot from the sample vial and transfer the aliquot to a specimen transfer tube.

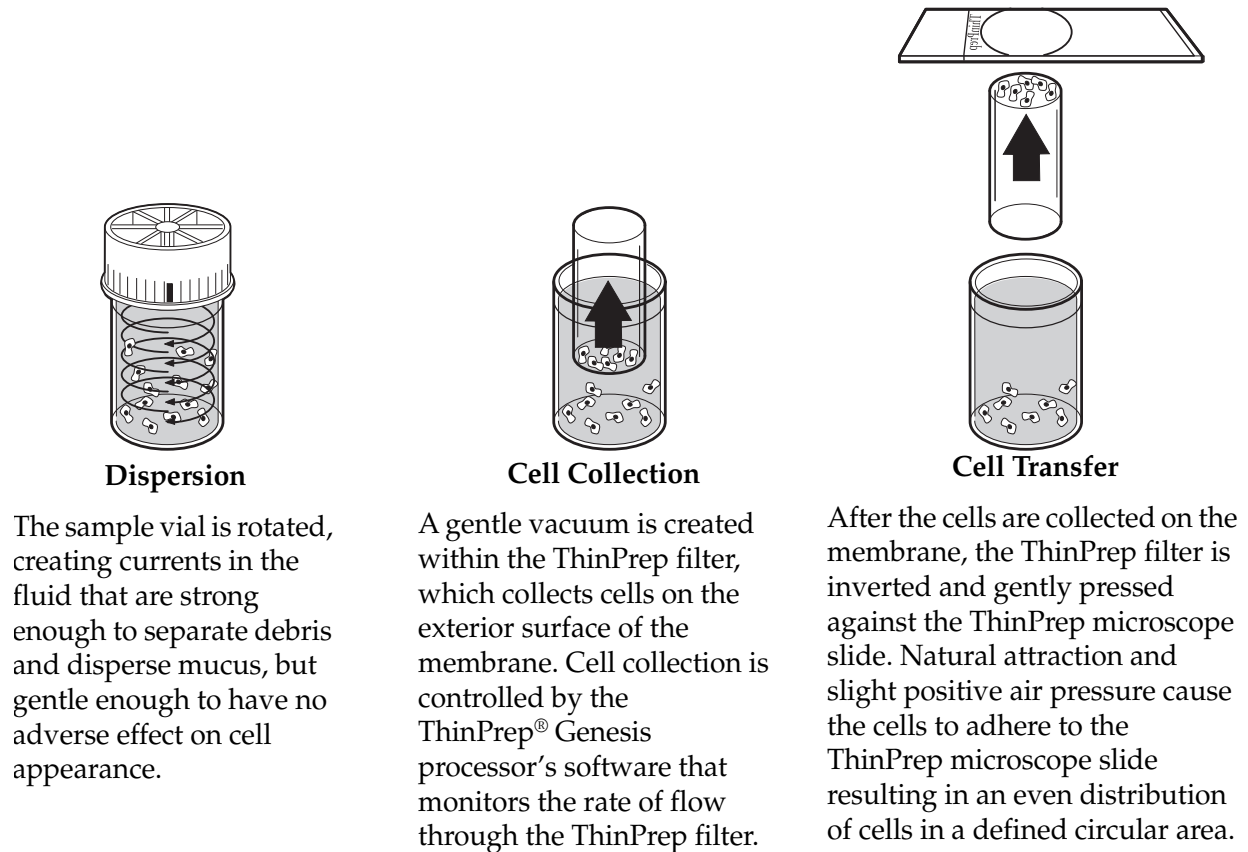

Figure 1-2 The ThinPrep sample preparation process

As with conventional Pap smears, slides prepared with the ThinPrep Genesis system are examined in the context of the patient's clinical history and information provided by other diagnostic procedures such as colposcopy, biopsy, and human papillomavirus (HPV) testing, to determine patient management.

Limitations

- Gynecologic samples collected for preparation using the ThinPrep Genesis processor should be collected using a broom-type cervical collection device or endocervical brush/plastic spatula combination collection device. Refer to the instructions provided with the collection device for warnings, contraindications, and limitations associated with specimen collection.
- Preparation of microscope slides using the ThinPrep Genesis processor should be performed only by personnel who have been trained by Hologic or by organizations or individuals designated by Hologic.

1 INTRODUCTION

- Evaluation of microscope slides produced with the ThinPrep Genesis processor should be performed only by cytotechnologists and pathologists who have been trained to evaluate ThinPrep-prepared slides by Hologic or by organizations or individuals designated by Hologic.
- Supplies used in the ThinPrep Genesis processor are those designed and specified by Hologic specifically for the ThinPrep Genesis processor. These include PreservCyt Solution vials, ThinPrep filters, and ThinPrep microscope slides. These supplies are required for proper performance of the system and cannot be substituted. Product performance will be compromised if other supplies are used. After use, supplies should be disposed of in accordance with local, state, and federal regulations.
- A ThinPrep filter must be used only once and cannot be reused.
- A ThinPrep microscope slide can be used only once. The slide can only have cells transferred onto it once.
- Refer to the instructions provided with the specimen transfer tube and the instructions provided with any subsequent assay to be run from the tube, for all collection, transport, and storage conditions concerning the tube.

Warnings

- For *in vitro* diagnostic use.
- Danger. PreservCyt Solution contains methanol. Toxic if swallowed. Toxic if inhaled. Causes damage to organs. Cannot be made non-poisonous. Consult Safety Data Sheet (SDS) at www.hologicsds.com. Wear personal protective laboratory gear. Flammable liquid and vapor. Keep away from heat, sparks, open flames and hot surfaces. Evaporating alcohol could create a fire hazard. Other solutions cannot be substituted for PreservCyt Solution. PreservCyt Solution should be stored and disposed of in accordance with all applicable regulations.
- Do not process a cerebral spinal fluid (CSF) specimen or other sample type that is suspected of possessing prion infectivity (PrPsc) derived from a person with a TSE, such as Creutzfeldt-Jakob disease, on the ThinPrep Genesis processor. A TSE-contaminated processor cannot be effectively decontaminated and therefore must be properly disposed of in order to avoid potential harm to users of the processor or service personnel.
- Strong oxidizers, such as bleach, are incompatible with PreservCyt Solution and therefore should not be used to clean the waste bottle

Precautions

- This equipment generates, uses, and can radiate radio frequency energy, and if not installed and used in accordance with the operator's manual, may cause interference to radio communications. Operation of this equipment in a residential area is likely to cause harmful interference, in which case the user will be required to correct the interference at his/her own expense.

- PreservCyt Solution *with* cytologic sample intended for ThinPrep Pap testing must be stored between 15°C (59°F) and 30°C (86°F) and tested within 6 weeks of collection.
- PreservCyt Solution was challenged with a variety of microbial and viral organisms. The following table presents the starting concentrations of viable organisms and the number of viable organisms found after 15 minutes in the PreservCyt Solution. The log reduction of viable organisms is also presented. As with all laboratory procedures, universal precautions should be followed.

Organism	Initial Concentration	Log Reduction After 15 Minutes
<i>Candida albicans</i>	5.5 x 10 ⁵ CFU/ml	≥4.7
<i>Candida auris</i>	2.6 x 10 ⁵ CFU/ml	≥5.4
<i>Aspergillus niger</i>	4.8 x 10 ⁵ CFU/ml	2.7*
<i>Escherichia coli</i>	2.8 x 10 ⁵ CFU/ml	≥4.4
<i>Staphylococcus aureus</i>	2.3 x 10 ⁵ CFU/ml	≥4.4
<i>Pseudomonas aeruginosa</i>	2.5 x 10 ⁵ CFU/ml	≥4.4
<i>Mycobacterium tuberculosis</i> [†]	9.4 x 10 ⁵ CFU/ml	4.9**
Rabbitpox virus	6.0 x 10 ⁶ PFU/ml	5.5***
HIV-1	3.2 x 10 ⁷ TCID ₅₀ /ml	≥7.0***
Hepatitis B virus [†]	2.2 x 10 ⁶ TCID ₅₀ /ml	≥4.25
SARS-CoV-2 virus	1.8 x 10 ⁶ TCID ₅₀ /ml	≥3.75
* After 1 hour 4.7 log reduction ** After 1 hour 5.7 log reduction *** Data is for 5 minutes † Organisms were tested with similar organisms from the same genus to assess antimicrobial effectiveness		
Note: All log reduction values with a ≥ designation yielded undetectable microbial presence after exposure to PreservCyt Solution. The listed values represent the minimum allowable claim given the initial concentration and the detection limit of the quantitative method.		

1 INTRODUCTION

Components

Key system components include the ThinPrep Genesis processor, a PreservCyt[®] Solution sample vial, a fixative bath, a filter, a microscope slide, a pipette tip, and an Aptima[®] specimen transfer tube.

The system has two optional components: a slide printer for printing ID information on a slide and a tube printer for printing ID information on a tube. The tube printer is compatible with an Aptima specimen transfer tube that has a thermally sensitive label.

The system is operated via a touch screen graphical user interface. The interface is available in several languages, via a user preference.

All specimen samples are collected into PreservCyt Solution vials.

The operator selects the type of sample to process. The sample vial and a corresponding ThinPrep microscope slide and/or tube are labeled with accession numbers and are loaded into the processor for processing. A ThinPrep filter is also loaded for each cytology sample. A pipette tip is used for each aliquot from the sample. For cytology samples, a bath containing fixative alcohol is placed into the processor.

The sample vial is placed into the ThinPrep Genesis processor.

The operator closes the door before the processing begins. The system processes one sample vial at a time.

Materials Required

Materials Provided

The following items are included when the ThinPrep[®] Genesis processor is delivered for installation. (These items may vary according to your order.)

- ThinPrep Genesis processor
- ThinPrep Genesis Processor Operator's Manual
- Power cord
- Waste bottle with tubing harness and transport cover
- Fixative baths (10)
- Pipette tip disposal cup (2)
- Absorbent pads for the filter plug (4)
- Absorbent pads for the filter puncture area (4)
- Pipette tip holder (2)
- Multi-channel pipette tip gripper (to transfer the pipette tips from their packaging to the processor, for customers performing aliquot removal)
- Pipette tips (for customers performing aliquot removal)

- Slide printer (optional)
- Tube printer (optional)
- USB key(1)

Additional items supplied

- ThinPrep PreservCyt Solution vials
- ThinPrep filters
- ThinPrep microscope slides
- Dispenser pump
- Aptima® specimen transfer tubes (for customers performing aliquot removal)
- Pipette tips (for customers performing aliquot removal)

1 INTRODUCTION

Materials Required But Not Provided

- Slide staining system and reagents
- Standard laboratory fixative
- Coverslips and mounting media
- Lint-free wipes
- Sodium hypochlorite solution (0.5% solution, for customers performing aliquot removal)
- Personal protective equipment

Storage

- Store PreservCyt® Solution between 15°C (59°F) and 30°C (86°F). Do not use beyond the expiration date printed on the container.
- Store PreservCyt Solution *with* cytologic sample intended for ThinPrep Pap testing between 15°C (59°F) and 30°C (86°F) for up to 6 weeks.
- Refer to the instructions provided with the specimen transfer tube and the instructions provided with any subsequent assay to be run from the tube, for all collection, transport, and storage conditions concerning the tube.
- Store ThinPrep filters in their trays with the cover on until ready for use.
- Store ThinPrep filters in an ambient environment and out of direct sunlight.
- Check the expiration date printed on the ThinPrep filter tray label and discard if outdated.
- Store pipette tips as described on their packaging.

SECTION B PRINCIPLES OF OPERATION

The ThinPrep Genesis processor makes use of mechanical, pneumatic, and fluidic principles for cell dispersion, collection, and transfer. A rotary drive mechanism gently disperses samples. A pneumatic/fluidic system, controlled by a microprocessor, monitors cell collection and cell transfer.

Each ThinPrep processor slide preparation processing sequence is optimized for the biological characteristics of the various cytological specimens.

The ThinPrep Genesis processor also makes use of mechanical, pneumatic, and fluidic principles to move a pipette tip from the storage area onto the pipettor, to pipette, and to eject a used pipette tip. The pipetting system is also controlled by a microprocessor.

The optional slide printer is a thermal transfer printer which uses a printer ribbon. The optional tube printer is a direct thermal printer which requires the tube to bear a thermal-sensitive label.

The ThinPrep processor slide preparation and aliquot removal process can be divided into the phases illustrated in Figure 1-3.



Figure 1-3 Slide processing and aliquot removal on the ThinPrep Genesis processor

The following sections describe the principles of each of these phases in detail.

Sample Preparation/Vial Labeling

Before the ThinPrep processor can process gynecologic samples, the samples must be placed into PreservCyt Solution. Gynecologic samples must be prepared according to the protocols described in Chapter 4, “Gynecologic Sample Preparation” and non-gynecologic samples must be prepared as described in Chapter 5, “Non-Gynecologic Sample Preparation”. Once the cells are added to the PreservCyt Solution vial by the appropriate method, the processor can process the sample vial.

Before the ThinPrep processor processes the sample, the sample is typically labeled with an ID.

Instrument Loading

In preparation for sample processing, the operator loads essential items into the ThinPrep Genesis processor. The processes of loading and operating the processor are explained in Chapter 7, “Operating Instructions”.

Labeling the slide and the tube and checking that the slide and tube are properly labeled can be steps in the loading process, depending on a laboratory’s preference. Refer to Chapter 7, “Operating Instructions” for more information.

Start of Cycle

When the operator initiates a sequence, the ThinPrep Genesis processor verifies the installation of disposables, the motor positions, and the positive and negative pressures in the pressure reservoirs. After this, the instrument processes the sample using the selected sequence.

Dispersion

The robot in the ThinPrep Genesis processor grasps the sample vial cap, positioning the vial to allow the processor to tighten the vial cap. The processor verifies that the cap is tightly sealed and then mechanical features on the processor hold the vial while the dispersion system bi-directionally rotates the capped ThinPrep vial, creating shear forces in the fluid that are strong enough to separate randomly joined material and disperse mucus, and are not known to have an adverse effect on the cellular architecture or on adhesive forces joining diagnostically relevant groups of cells.

Uncapping and Capping

The robot in the ThinPrep Genesis processor grasps the sample vial cap. For processes where the operator has selected aliquot removal on the ThinPrep Genesis processor, the robot also grasps the tube cap. Mechanical features on the processor hold the vial and tube and slowly spin the vial and spin the tube to remove the cap from the vial and the cap from the tube. These same mechanical features hold the vial still while the vial is uncapped and hold the tube still while the tube is uncapped. The robot continues to grasp the cap(s) up to the point in the process where the tube is recapped and the point where the vial is recapped. To recap, the robot positions the cap near the tube and near the vial, and the mechanical spinning process proceeds in the opposite direction.

Fluid Level Detection

The robot in the ThinPrep Genesis processor rotates, raises and lowers to lower the pipette tip or a filter to make contact with the surface of fluid in the uncapped vial. If the fluid level is satisfactory, the processor will continue the process. An error message and audible alarm indicate an unsatisfactory fluid level.

Depending on the items to be processed, the ThinPrep Genesis processor may detect the fluid level in the vial with the pipette tip, with the filter, or it may detect the fluid level twice, first with the pipette tip and then, after aliquot removal, with the filter.

Depending on the items to be processed, the ThinPrep Genesis processor may detect the fluid level in the tube with the pipette tip. The fluid level in the tube is checked before the aliquot is added to confirm that fluid is present in the tube. The fluid level in the tube is checked after dispensing the aliquot to verify that the aliquot is completely dispensed.

Pipetting

For processes where the operator has selected aliquot removal on the ThinPrep Genesis processor, the robot and pipette tip storage area move to automatically load a single-use pipette tip onto the pipettor component of the robot and to move the pipette tip into the sample vial. The pneumatic system applies negative pressure to the pipettor to draw PreservCyt Solution and suspended cellular material into the pipette tip. The robot introduces the pipette tip into the sample transfer tube and the pneumatic system releases pressure to deposit the aliquot into the uncapped tube. Then robot moves the pipette tip so that the processor can mechanically eject the pipette tip into the pipette tip waste disposal cup.

Filter Wetting

For processes where the operator has selected slide preparation on the ThinPrep Genesis processor, the robot rotates and moves up and down to position the filter in the uncapped vial. Negative pressure is briefly applied, drawing a small amount of fluid through the ThinPrep filter to wet it. Following wetting, the system gently blows out the liquid in the ThinPrep filter. This clears any cellular material from the filter surface.

Cell Collection

For processes where the operator has selected slide preparation on the ThinPrep Genesis processor, a ThinPrep filter collects cells from the sample. The filter membrane is biologically neutral and is mounted at one end of the ThinPrep filter cylinder. The membrane is a flat, smooth, porous surface that collects the cellular material on one plane.

The pneumatic system applies negative pressure to the filter in a series of pulses. These negative pressure pulses (sips) draw PreservCyt Solution through the filter membrane and collect suspended cellular material onto the outer membrane surface.

The collection process ceases when a target filter coverage, predetermined by the processor sequence, is attained. Cell collection is controlled by an embedded microprocessor that monitors the pressure in

1 INTRODUCTION

the ThinPrep filter cylinder. After collection, the cells sit on a single plane over the pores, ready for transfer to the slide. Figure 1-4 illustrates cell collection.

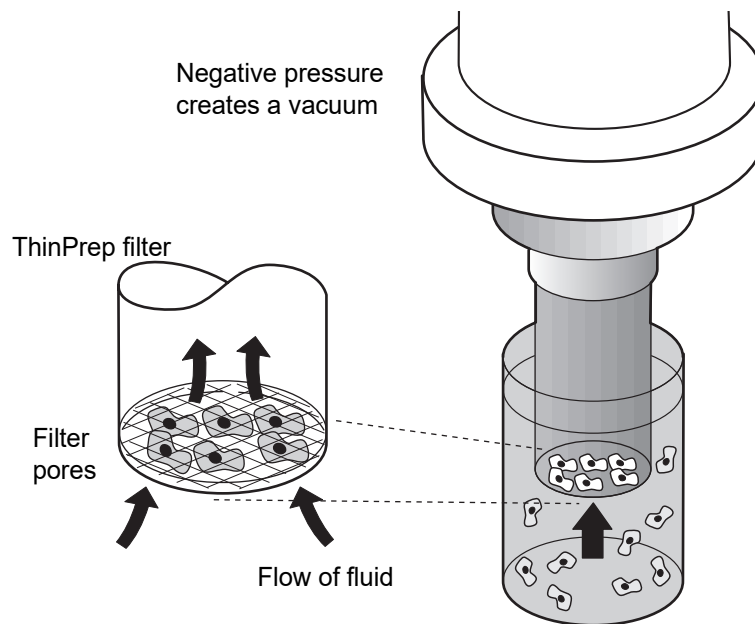

Figure 1-4 Cell collection on a ThinPrep filter

Waste Clearing

For processes where the operator has selected slide preparation on the ThinPrep Genesis processor, when collection ends, the ThinPrep filter is withdrawn from the sample vial and the filtrate is aspirated into the waste bottle as the filter is inverted. The collected cells remain on the ThinPrep filter due to the negative holding pressure.

Bubble Point

For processes where the operator has selected slide preparation on the ThinPrep Genesis processor, bubble point removes excess fluid from the filter membrane prior to transferring cells onto the slide to enhance cell adhesion to the slide.

Bubble point is performed after all of the fluid is evacuated. This is evident by the bubbling activity on the inside of the filter membrane. Cells do not air-dry during bubble point.

Cell Transfer

For processes where the operator has selected slide preparation on the ThinPrep Genesis processor, when bubble point is complete, the slide gripper moves the slide into contact with the inverted ThinPrep filter.

The natural adhesion properties of cells to the glass slide are responsible for the transfer of cells from the filter membrane to the slide. The cells have a higher affinity for the glass slide than for the membrane; slight positive air pressure behind the filter membrane enhances cell transfer.

Deposit Slide

For processes where the operator has selected slide preparation on the ThinPrep Genesis processor, once cell transfer is complete, the slide is removed from contact with the filter and automatically deposited into the fixative bath.

Filter Puncture

For processes where the operator has selected slide preparation on the ThinPrep Genesis processor, once cell transfer is complete, the robot rotates and lowers the filter to puncture the filter membrane so that the single-use filter cannot be reused.

Cycle Completion

All the motorized mechanisms return to their initial positions and the display returns to the Main Menu. If the system detects an error during the process, a message will be displayed and an audible alarm will sound.

1

INTRODUCTION

SECTION C

THINPREP GENESIS PROCESSOR TECHNICAL SPECIFICATIONS

Overview of Components

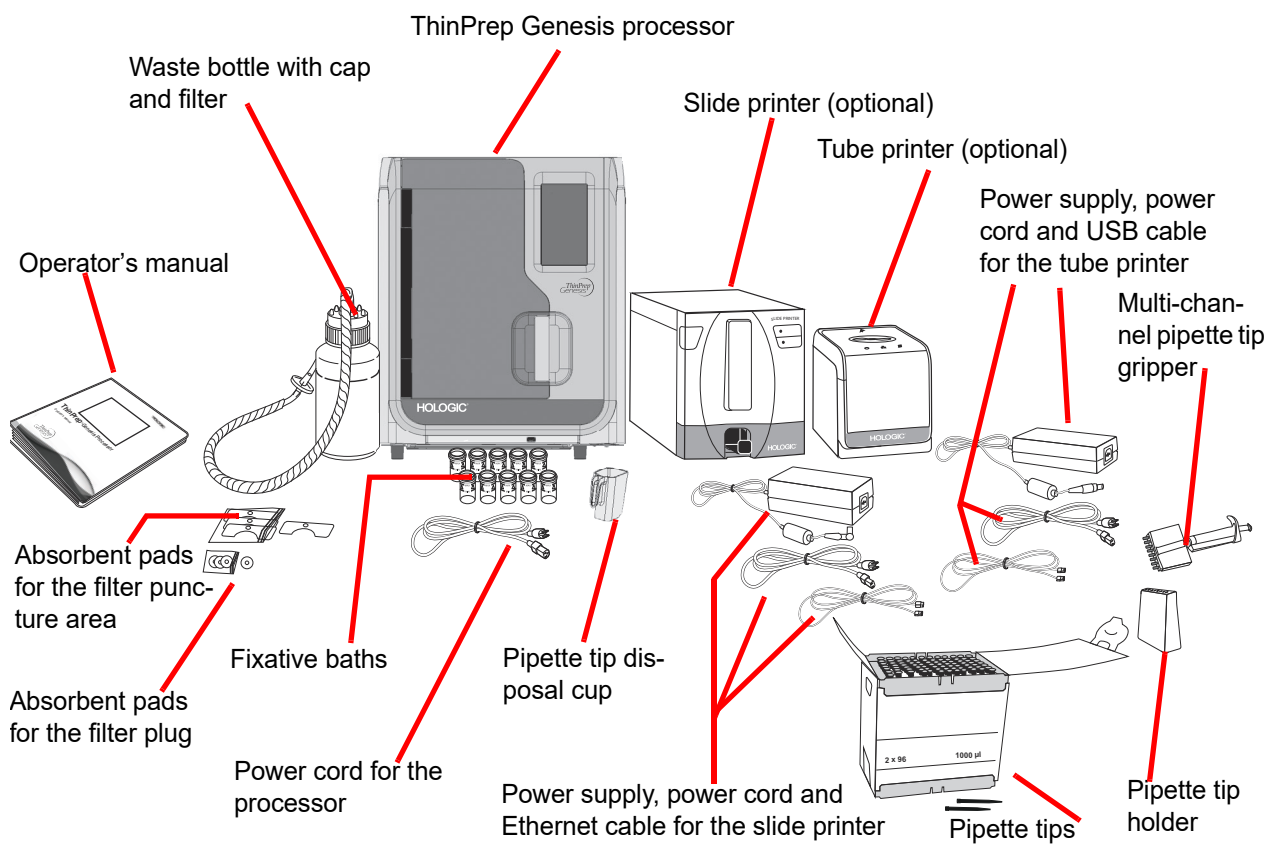

Figure 1-5 ThinPrep Genesis system components

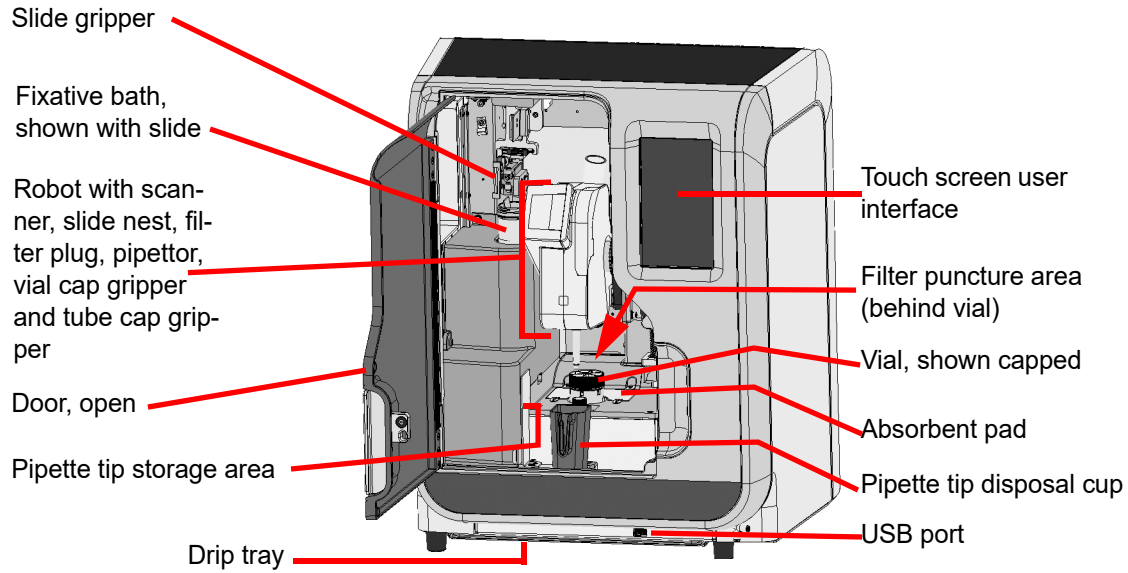

Figure 1-6 ThinPrep Genesis processor

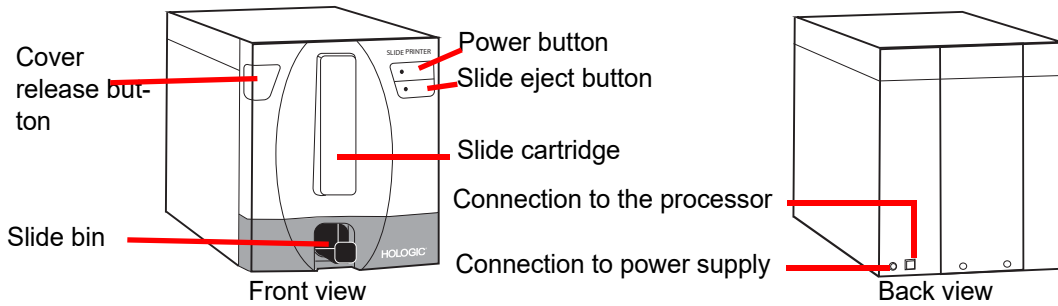

Figure 1-7 Slide printer (optional)

1 INTRODUCTION

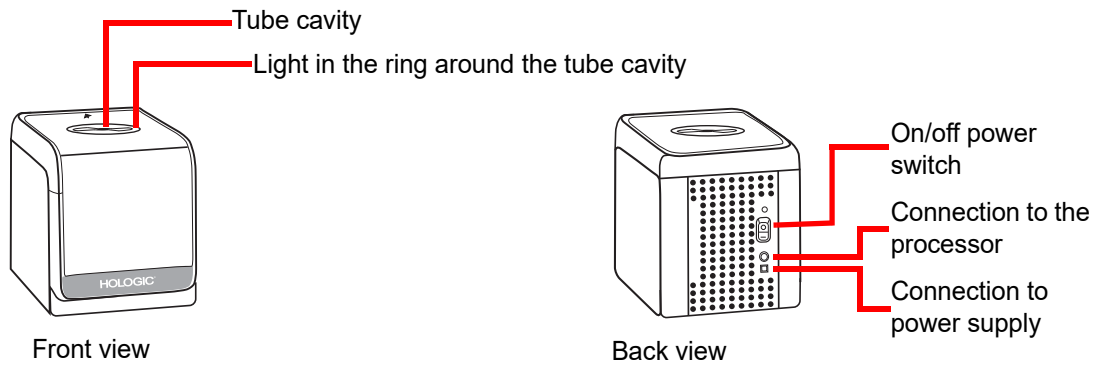

Figure 1-8 Tube printer (optional)

ThinPrep Genesis System Dimensions and Clearances

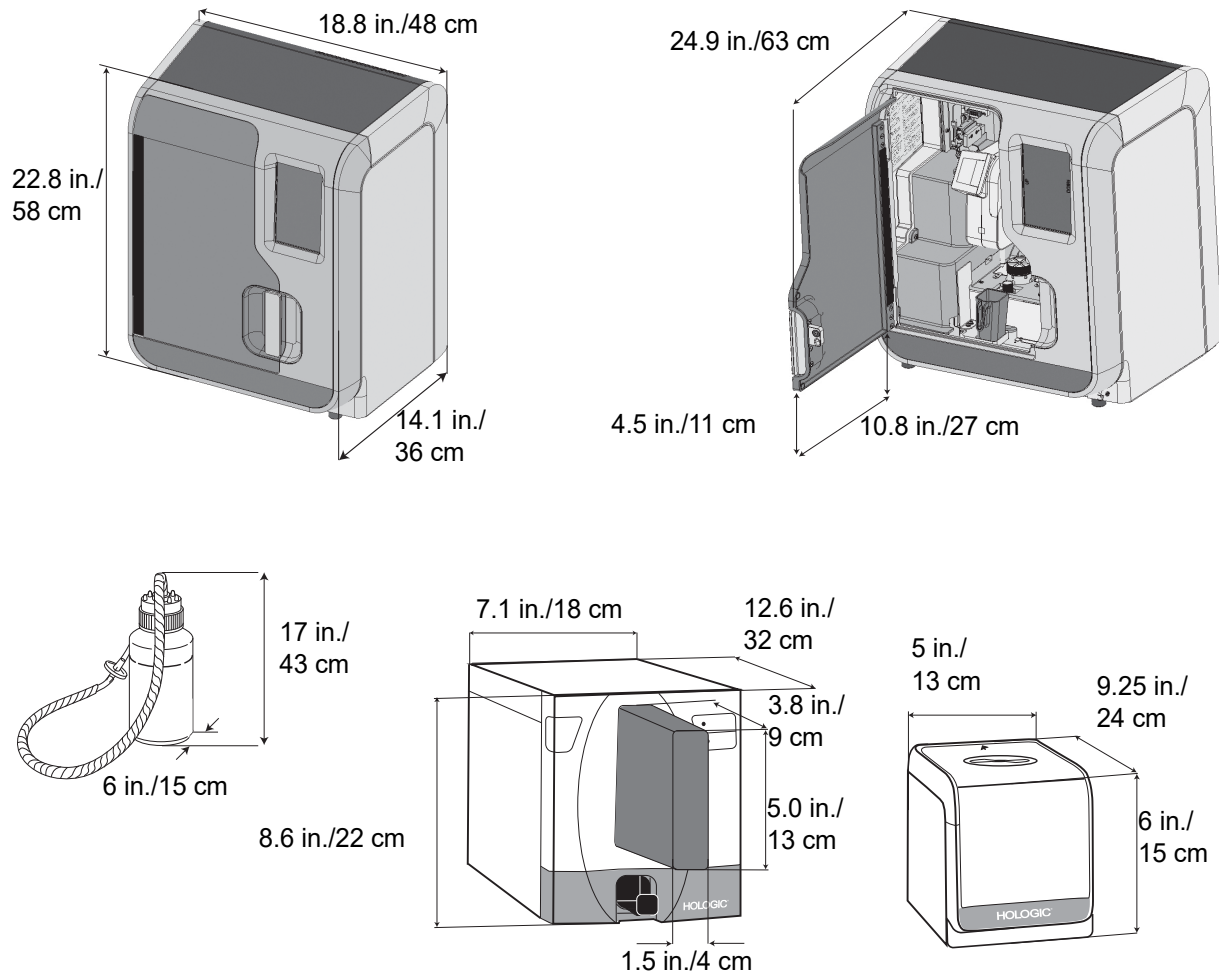

Figure 1-9 System dimensions and clearances

Dimensions and Weight (Approximate)

ThinPrep Genesis processor: 22.8 in./58 cm H x 18.8 in./48 cm W x 14.1 in./36 cm D
89 lbs/40.3kg

Waste bottle: 17 in./43 cm H x 6 in./15 cm diameter

Slide printer (optional): 8.6 in./22 cm H x 7.1 in./18 cm W x 12.7 in./32 cm D, 17 lbs/7.6 kg

Tube printer (optional): 6 in./15 cm H x 5 in./13 cm W x 9.2 in./24 cm D, 5.6 lbs/2.5 kg

Consider the weight of the slide printer, the tube printer, and a full waste bottle before lifting them. Due to the weight of the processor, use the help of another person if you need to lift it.

1 INTRODUCTION

Environmental

Operating Temperature

16–32°C

60–90°F

Operating Humidity

20%–80% RH, non-condensing

Non-operating (Shipping and storage) Temperature

-28–50°C

-20–122°F

Pollution Degree: II, in accordance with IEC 60664.

Category II, the ThinPrep Genesis System is for indoor use only in an office or a clean laboratory environment.

Altitude: 0 meters (sea level) to 2000 meters.

Atmospheric Pressure: 1100 millibar to 500 millibar.

Sound levels

Maximum A-weighted sound pressure level at the operator's position and at a bystander's position is less than 80 dBA.

Power

Electrical Voltage

ThinPrep Genesis processor:

100-120 VAC~3A 47-63 Hz

220-240 VAC ~1A 47-63 Hz

300 Watts maximum

Slide printer (optional):

100-240 VAC, 50/60 Hz, 60 watts

Tube printer (optional):

24 VDC/4.5A

50/60 Hz

Fusing

ThinPrep Genesis processor:

Two 10A/250V 3AG glass, time delay

ThinPrep Genesis System Standards

The ThinPrep Genesis System has been tested and certified by a U.S. nationally recognized testing Laboratory (NRTL) to comply with current Safety, Electro-Magnetic Interference (EMI) and Electro-Magnetic Compatibility (EMC) standards. Refer to the processor product label, located on the rear of the instrument, to see the safety certification markings.

This equipment meets the emission and immunity requirements of IEC 61326-2-6. This equipment has been designed and tested to CISPR 11 Class A. In a domestic environment it may cause radio interference, in which case, you may need to take measures to mitigate the interference. The electromagnetic environment should be evaluated prior to operation.

Do not use this device in close proximity to sources of strong electromagnetic radiation (e.g., unshielded intentional radio frequency sources), as these may interfere with the proper operation.

Caution: Changes or modifications to this unit not expressly approved by the party responsible for compliance could void the user's authority to operate the equipment.

This equipment has been tested and found to comply with the limits for a Class A digital device, pursuant to Part 15 of the FCC Rules. These limits are designed to provide reasonable protections against harmful interference when the equipment is operated in a commercial environment. This equipment generates, uses, and can radiate radio frequency energy; and if not installed and used in accordance with the instruction manual may cause harmful interference to radio communications. Operation of this equipment in a residential area is likely to cause harmful interference, in which case the user will be required to correct the interference at his own expense.

This product is *in vitro diagnostic* (IVD) medical equipment.

1 INTRODUCTION

SECTION D INTERNAL QUALITY CONTROL

Power On Self Test (POST)

When the ThinPrep Genesis processor is powered on (refer to page 2.6), the system goes through a self-diagnostic test. The electrical, mechanical and software/communications subsystems are tested to confirm that each performs properly. The operator is alerted to malfunctions by a message on the user interface touch screen.

SECTION E THINPREP GENESIS PROCESSOR HAZARDS

The ThinPrep Genesis processor is intended to be operated in the manner specified in this manual. Be sure to review and understand the information listed below in order to avoid harm to operators and/or damage to the instrument.

If this equipment is used in a manner not specified by the manufacturer, then the protection provided by the equipment may be impaired.

Warnings, Cautions and Notes

The terms **WARNING**, **Caution** and **Note** have specific meanings in this manual.







A **WARNING** advises against certain actions or situations that could result in personal injury or death.

A **Caution** advises against actions or situations that could damage equipment, produce inaccurate data or invalidate a procedure, although personal injury is unlikely.



A **Note** provides useful information within the context of the instructions being provided.

Symbols Used on the System

The following symbols may appear on the processor or accessories:

Symbol	Title	Description	Standard information
	Direct Current	to indicate on the rating plate that the equipment is suitable for direct current only; to identify relevant terminals.	ISO 7000/IEC 60417 Graphical symbols for use on equipment, symbol 5031
	Caution	Indicates the need for the user to consult the instructions for use for important cautionary information such as warnings and precautions that cannot, for a variety of reasons, be presented on the medical device itself.	ISO 15223-1 Medical devices—Symbols to be used with medical device labeling and information to be supplied, Section 5.4.4
	<i>In vitro</i> diagnostic medical device	Indicates a medical device that is intended to used as an <i>in vitro</i> diagnostic medical device	ISO 15223-1 Medical devices—Symbols to be used with medical device labeling and information to be supplied, Section 5.5.1
	Authorized Representative in the European Community	Indicates the Authorized Representative in the European Community	ISO 15223-1 Medical devices—Symbols to be used with medical device labeling and information to be supplied, Section 5.1.2
	Manufacturer	Indicates the medical device manufacturer, as defined in the EU Directives 90/385/EEC, 93/42/EEC and 98/79/EC	ISO 15223-1 Medical devices—Symbols to be used with medical device labeling and information to be supplied, Section 5.1.1
	Date of manufacture	Indicates the date when the medical device was manufactured	ISO 15223-1 Medical devices—Symbols to be used with medical device labeling and information to be supplied, Section 5.1.3
	Catalogue number	Indicates the manufacturer's catalogue number so that the medical device can be identified	ISO 15223-1 Medical devices—Symbols to be used with medical device labeling and information to be supplied, Section 5.1.6

1 INTRODUCTION

	Serial number	Indicates the manufacturer's serial number so that a specific medical device can be identified	ISO 15223-1 Medical devices—Symbols to be used with medical device labeling and information to be supplied, Section 5.1.7
	Consult instructions for use	Indicates the need for the user to consult the instructions for use	ISO 15223-1 Medical devices—Symbols to be used with medical device labeling and information to be supplied, Section 5.4.3
	Do not re-use	Indicates a medical device that is intended for one use, or for use on a single patient during a single procedure	ISO 15223-1 Medical devices—Symbols to be used with medical device labeling and information to be supplied, Section 5.4.32

And, this instrument uses the following markings:



Product can be used safely during an environmental protection use period of 50 years (as defined in China the RoHS standard)



Waste Electrical and Electronic Equipment - contact Hologic for disposal of the instrument.



Product meets the requirements for CE marking in accordance with EU-IVD Regulation 2017/746



Caution: Federal (USA) law restricts this device to sale by or on the order of a physician, or any other practitioner licensed by the law of the State in which the practitioner practices to use or order the use of the device and are trained and experienced in the use of the product.



The ETL Mark is proof of product compliance to North American safety standards. Authorities Having Jurisdiction (AHJs) and code officials across the US and Canada accept the ETL Listed Mark as proof of product compliance to published industry standards.

Location of Labels Used on the System

Warning: FLAMMABLE LIQUIDS. Keep away from fire, heat, sparks and flame.

Warning: MOVING PARTS. Keep hands, hair, loose clothing, etc. clear. Only operate with door closed.

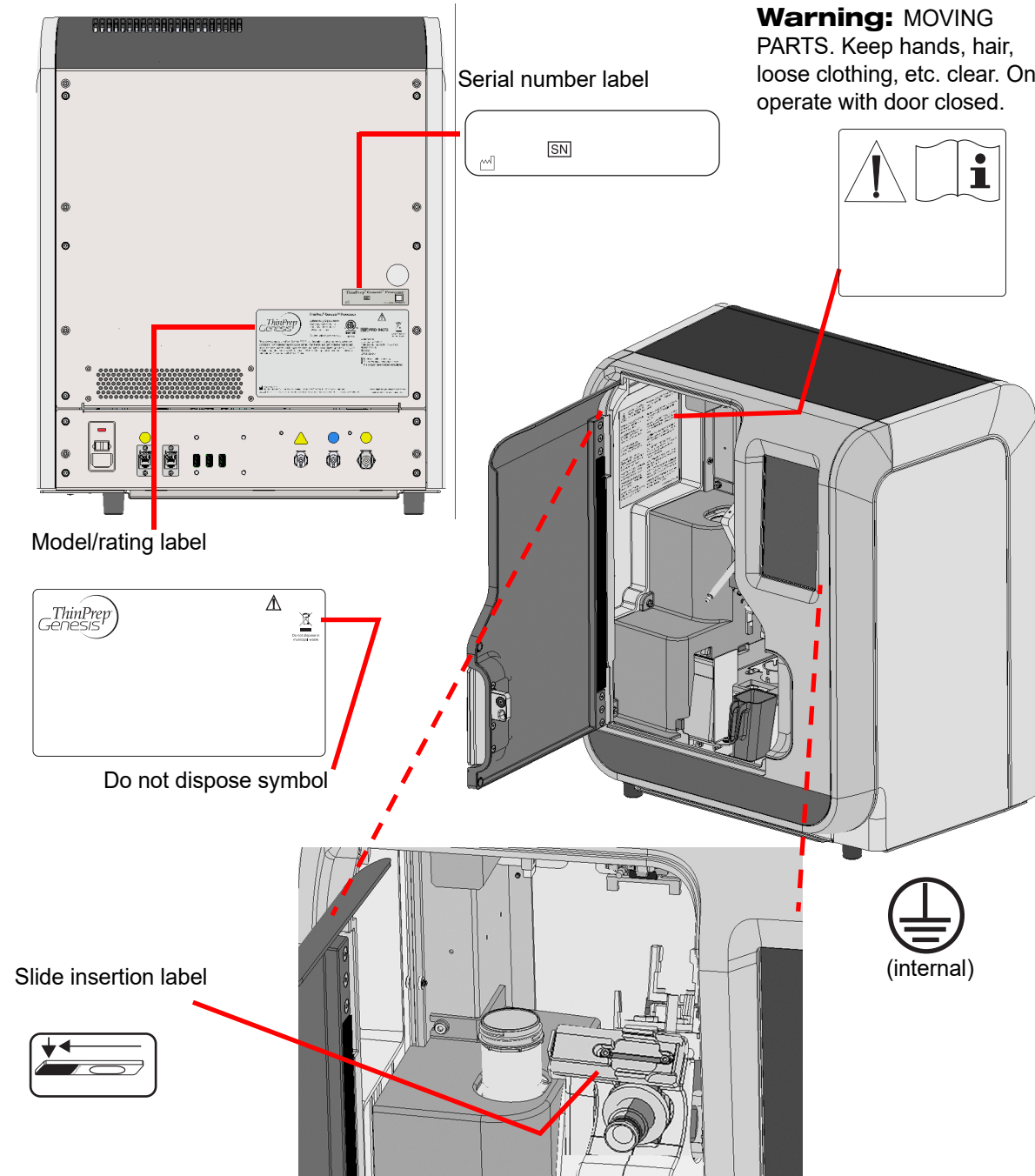

Figure 1-10 Location of labels used on the processor

1 INTRODUCTION

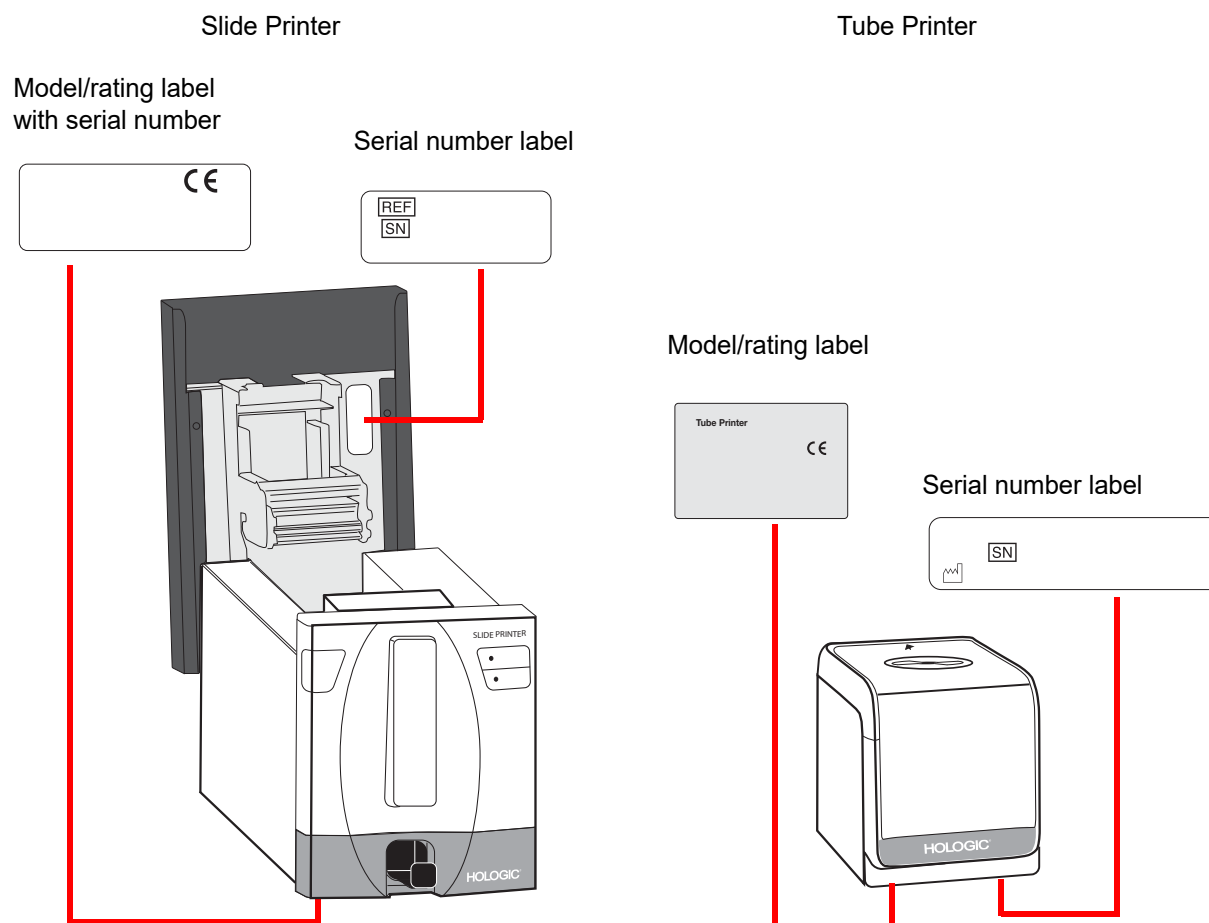

Figure 1-11 Location of labels used on the optional slide printer and optional tube printer

Warnings Used in this Manual:

WARNING: Moving parts

The instrument contains moving parts. Keep hands, loose clothing, jewelry, etc., clear.

WARNING: Grounded outlet

To ensure safe operation of the instrument, use a three-wire grounded outlet. Disconnection from the power supply source is by removal of the power cord.

WARNING: Glass

The instrument uses microscope slides, which have sharp edges. In addition, the slides may be broken in their storage packaging or on the instrument. Use caution when handling glass slides and cleaning the instrument.

WARNING: Sharp edges

The slide gripper fingers have sharp edges. Use caution when cleaning the slide gripper fingers.

WARNING: Flammable liquid and vapor

Flammable liquid and vapor. Keep away from heat, sparks, open flames and hot surfaces. Evaporating alcohol could create a fire hazard.

WARNING: Toxic mixture

Danger. PreservCyt Solution contains methanol. Toxic if swallowed. Toxic if inhaled. Refer to Safety Data Sheet (SDS) at www.hologicsds.com for safe handling instructions. Wear personal protective laboratory gear.

1 INTRODUCTION

SECTION F DISPOSAL

Disposal of Consumable Items

- **Fix reagent.** Follow local, state, provincial and federal or county guidelines. Dispose of all solvents as hazardous waste.
- **Waste bottle contents.** Dispose of all solvents as hazardous waste. Follow local, state, provincial and federal or county guidelines. As with all laboratory procedures, universal precautions should be followed.
- **PreservCyt solution.** Follow local, state, provincial and federal or county guidelines. Dispose of all solvents as hazardous waste.
- **Used filters.** Dispose of as regular waste.
- **Absorbent pads.** Dispose of as regular waste. (If dripping wet, dispose of as hazardous waste.)
- **Waste filter.** Dispose of as regular waste.
- **Pinch valve tubing.** Dispose of as regular waste.
- **Pipette tips.** Dispose of as regular waste. Follow local, state, provincial and federal or county guidelines.
- **Specimen transfer tube contents.** Follow local, state, provincial and federal or county guidelines.
- **CytoLyt solution.** Dispose of as hazardous waste. Follow local, state, provincial and federal or county guidelines. Dispose of all solvents as hazardous waste.
- **Broken glass.** Dispose of in a Sharps container.

Disposal of the Equipment

Waste electrical & electronic equipment (WEEE)

Hologic is dedicated to meeting country specific requirements associated with the environmentally sound treatment of our products. Our objective is to reduce the waste arising from our electrical and electronic equipment. Hologic realizes the benefits of subjecting such WEEE equipment to potential reuse, treatment, recycling or recovery to minimize the amount of hazardous substances entering the environment.

Your responsibility

As a Hologic customer, you are responsible for ensuring that devices marked with the symbol shown below are not placed into the municipal waste system unless authorized to do so by the authorities in

your area. Please contact Hologic (see below) prior to disposing any electrical equipment provided by Hologic.

Symbol used on the instrument

The following symbol is used on this instrument:

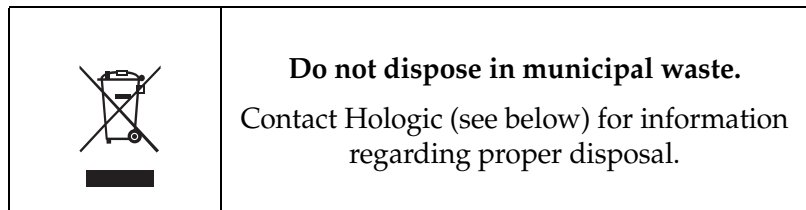
**Reclamation**

Hologic will provide for the collection and proper reclamation of electrical devices we provide to our customers. Hologic strives to reuse Hologic devices, subassemblies, and components whenever possible. When reuse is not appropriate, Hologic will ensure the waste material is properly disposed of.

Contact information**Corporate headquarters**

Hologic, Inc.
250 Campus Drive
Marlborough, MA 01752 USA
Tel: (USA and Canada)
1-800-442-9892
Fax: 1-508-263-2967



1 INTRODUCTION

This page intentionally left blank.

Chapter Two

ThinPrep Genesis Processor Installation

SECTION A

GENERAL

The ThinPrep[®] Genesis[™] processor must be installed by personnel who have completed Hologic service training for the processor. When installation is complete, the operator(s) are trained, using the operator's manual as the training guide.

SECTION B

ACTION UPON DELIVERY

Remove and read the *Operating Instructions Prior to Installation* sheet attached to the packing carton.

Inspect the packing cartons for damage. Report any damage immediately to the shipper and/or Hologic Technical Support as soon as possible. (Refer to Chapter 12, "Service Information".)

Leave the instrument in the packing cartons for Hologic service installation.

Store the instrument in a suitable environment until installation (cool, dry, vibration-free area).

Checklist for contents of shipping container and accessory kits

- ThinPrep Genesis processor
- ThinPrep Genesis Processor Operator's Manual
- Power cord, 6 feet (1.8 m)
- Waste bottle assembly, includes bottle, bottle cap, tubing set, fittings, waste filter
- Fixative baths (10)
- Pipette tip disposal cup (2)
- Absorbent pads for the filter plug (4)
- Absorbent pads for the filter puncture area (4)

2

THINPREP GENESIS PROCESSOR INSTALLATION

- Pipette tip holder (2)
- Multi-channel pipette tip gripper (to transfer the pipette tips from their packaging to the processor, for customers performing aliquot removal)
- Pipette tips (for customers performing aliquot removal)
- Box to support pipette tips (2; for customers performing aliquot removal)
- Slide printer, with power supply and USB cable (for orders that include the optional slide printer)
- Power cord for the slide printer (for orders that include the optional slide printer)
- Tube printer, with power supply and ethernet cable (for orders that include the optional tube printer)
- Power cord for the tube printer (for orders that include the optional tube printer)
- USB key(1)

Caution: Turning the power on before instructed to do so can damage the instrument and invalidate your warranty.

SECTION C

PREPARATION PRIOR TO INSTALLATION

Pre-Installation Site Assessment

A pre-installation site assessment is performed by Hologic service personnel. Be sure to have prepared any and all site configuration requirements as instructed by the service personnel.

Location

Locate the ThinPrep Genesis processor near (within 3 meters of) a three-wire grounded power outlet that is free of voltage fluctuations and power surges. The components of the ThinPrep Genesis processor should be close enough to comfortably make all connections.

During operation the ThinPrep Genesis processor is sensitive to vibrations. It should be placed on a sturdy bench that can support the 89 lbs (40.3 kg) that the processor weighs. The bench should be away from centrifuges, vortexors, or any other equipment that may cause vibrations. If the location of the processor must be in proximity to one of these devices, it should not be operating at the same time as any of these other devices.

Allowing for adequate clearances, the following space is required for the ThinPrep processor:
H = 22.8 in./58 cm, W = 14.1 in./36 cm. (Refer to Figure 1-9.)

The waste bottle may be placed either on the bench with the processor or below the processor. The waste bottle will occupy an area approximately a 6 in./15 cm square by 17 in./43 cm high.

Security

Limit Access to Trusted Users

The ThinPrep Genesis processor does not require a user logon and is accessible to anyone who has physical access to the system. The system is a non-networked standalone device which does not contain any patient or sensitive data. There are minimal cybersecurity risks to the system but someone with physical access to the system could cause unintentional or intentional harm. This harm is limited to causing a non-functional system which could delay sample processing in the lab. Hologic recommends that the processor should be located in an area that is only accessible to trusted users as the customer sees fit.

In the event of a non-functioning system, contact Hologic Technical Support as detailed in the Service Information section of this manual.

Cybersecurity Safeguards

Hologic incorporates secure design principles into the product development life cycle to minimizing cybersecurity risks. The following safeguards are provided in the ThinPrep Genesis processor:

1. The system operates in a kiosk mode enabling the User to only run the Hologic ThinPrep Genesis application software. Access to the desktop and Windows Operating system is prevented. This denies the operator direct access to data stored on the System and all Windows features.
2. McAfee Embedded Control, a whitelisting security software, converts the Operating System into a closed “white box,” preventing execution of unauthorized code and buffer overflow exploits as well as providing malware protection (including zero-day attacks), and only allows for software upgrades using digitally signed software that was created in a controlled environment.
3. The Windows Operating System is hardened to reduce vulnerability by removing software, usernames/logins, and the disabling or removal of services not required for the normal operation of the System. Windows Group policy is also employed to control the working environment of user accounts and the workstation. For example, the USB autorun feature is disabled.
4. Access to the Service Interface is password protected so only Hologic Field Service engineers can use these functions.
5. The instrument is stand alone and does not connect to an external network.
6. There is no patient or sensitive data stored on the system.



THINPREP GENESIS PROCESSOR INSTALLATION

Cybersecurity Updates

Hologic continually evaluates software updates, security patches, and the effectiveness of the implemented security safeguards to determine if updates are needed to mitigate emerging threats. Hologic will provide validated software updates and patches as needed throughout the lifecycle of the medical device to continue to assure its safety and effectiveness.

SECTION
D

STORAGE AND HANDLING - POST-INSTALLATION

During operation the ThinPrep Genesis processor is sensitive to vibrations. It should be placed on a sturdy bench away from centrifuges, vortexors or any other equipment that may cause vibrations.

The ThinPrep Genesis processor may be stored where it is installed. Be sure to clean and maintain the processor as described in the Maintenance chapter of this manual.

Warning: The fixative bath must be removed. Evaporating alcohol could create a fire hazard.

If the ThinPrep Genesis processor is to be moved or shipped to a new location, please contact Hologic Technical Support. (Refer to Service Information, Chapter 12.)

2

THINPREP GENESIS PROCESSOR INSTALLATION

SECTION E

TURN ON THE THINPREP GENESIS SYSTEM

1. To turn on the ThinPrep Genesis processor, press the rocker switch located near the power cord on the back of the processor to the on position. See Figure 2-1.

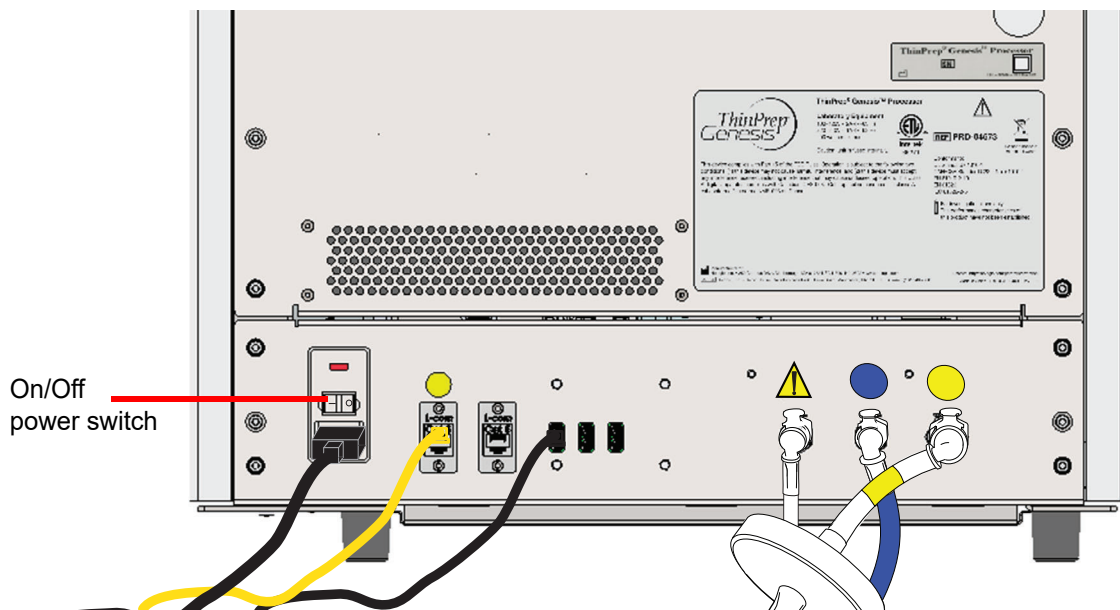

Figure 2-1 Power switch

The user interface will display the ThinPrep Genesis processor logo while the system boots and the main screen will appear when the processor is ready for use. The pump/compressor will be heard to energize and the mechanisms will move and then position for access. The door will unlock.

Note: The ThinPrep Genesis processor is intended to be left on. For shutdown or extended shutdown, see page 2.7.

2. To turn on the optional tube printer, press the rocker switch on the back of the tube printer. The light around the tube cavity will illuminate green.
3. To turn on the optional slide printer, press the power button in the upper right of the front of the printer. The light on the power button will illuminate blue.

SECTION
F

SET USER PREFERENCES

The following preferences may be set via the touch screen interface. These settings may be reset at any time and any settings will persist even if the processor is powered off and powered on again.

- Set the Date/time - page 6.11
- Set the Language - page 6.12
- Set the Lab name - page 6.12
- Set the Instrument name - page 6.13
- Adjust the Sound - page 6.15
- Select Alert tones - page 6.16
- Auto-start with door close - page 6.17
- Set the Chain of custody - page 6.18
- Set communication with the Slide Printer - page 6.25
- Set communication with the Tube Printer - page 6.26
- Set the format used on Slide Labels - page 6.26
- Set the format used on Tube Labels - page 6.36
- Set up parameters for comparing sample IDs; Configure Barcodes - page 6.38

SECTION
G

TURN OFF THE THINPREP GENESIS SYSTEM

Normal Shutdown

If the ThinPrep Genesis processor is to be turned off, unload any items in it. Refer to Chapter 7, “Operating Instructions”.

Caution: Never turn off power to the processor without first quitting the application via the user interface.

If the processor is to be turned off, it must be in an idle state. If processing is in progress, either let it finish, or cancel the process. To shut down, touch the **Admin Options** button on the user interface and press the **Shutdown** button.



THINPREP GENESIS PROCESSOR INSTALLATION

A confirmation box will be displayed on the touch screen. Press the **Yes** button to proceed with system shutdown. Wait for the application to turn off (wait until the touch screen interface goes blank). Then turn off the power switch located on the back of the processor.

Press the **No** button to cancel shutdown and return to the Admin Options screen.

To turn off the optional tube printer, press the rocker switch on the back of the tube printer.

To turn off the optional slide printer, press the power button in the upper right of the front of the printer.

Taking the Instrument Out of Service (Extended Shutdown)

If the ThinPrep Genesis processor is to be shut down for an extended time, empty the waste bottle (Maintenance, Chapter 8), remove any items that may be on board and close the door. Follow the instructions for “Normal Shutdown” on page 2.7.

Completely remove power to the processor by unplugging the power cord from the wall outlet.

Completely remove power to the tube printer by unplugging the power cord from the wall outlet.

Completely remove power to the slide printer by unplugging the power cord from the wall outlet.

Chapter Three

PreservCyt® and CytoLyt® Solutions

The following sections describe the function and specifications of the cytologic preservative fluid, PreservCyt® Solution and of CytoLyt® Solution, the transportation medium used in specimen preparation prior to processing. Refer to the instructions provided with the specimen transfer tube and the instructions provided with any subsequent assay to be run from the tube, for all collection, transport, storage conditions, and Safety Data Sheets (SDS) concerning the tube.

SECTION A

PRESERVCYT® SOLUTION

PreservCyt Solution is a methanol-based, buffered solution designed to preserve cells during transport and slide preparation on the ThinPrep Genesis processor.

The slide preparation process on the ThinPrep processor also requires PreservCyt Solution for transporting and storing samples prior to processing. PreservCyt Solution is optimized for the ThinPrep processor slide preparation process and cannot be substituted with any other reagents.

Packaging

Please refer to the Ordering Information in this manual for part numbers and detailed information regarding the ordering of solutions and supplies for the ThinPrep Genesis processor.

- Vials (20 ml) of PreservCyt Solution are contained in each ThinPrep Pap test.

Composition

PreservCyt Solution is buffered solution containing methanol. It contains no reactive ingredients. It contains no active ingredients.

WARNING: Danger. PreservCyt Solution contains methanol. Toxic if swallowed. Toxic if inhaled. Causes damage to organs. Cannot be made non-poisonous. Keep away from heat, sparks, open flames and hot surfaces. Other solutions cannot be substituted for PreservCyt Solution.

Storage Requirements

- Store PreservCyt Solution between 15°C (59°F) and 30°C (86°F). Do not use beyond the expiration date printed on the container.

3

PRESERVCYT® AND CYTOLYT® SOLUTIONS

- Store PreservCyt Solution *with* cytologic sample intended for ThinPrep Pap testing between 15°C (59°F) and 30°C (86°F) for up to 6 weeks.
- Store PreservCyt Solution *with* non-gynecological sample between 4°C (39°F) and 37°C (98°F) for up to 3 weeks.
- Refer to the instructions provided with the specimen transfer tube for storage requirements for specimens transferred to the tube on the ThinPrep Genesis processor.
- Storage requirements for quantities of PreservCyt Solution are dependent on local regulations regarding the size and configuration of your facility. Please refer to the Solutions Storage Guide at the end of this chapter.

Transportation

When transporting a PreservCyt Solution vial containing cells, make sure the vial is tightly sealed. Align the mark on the cap with the mark on the vial to prevent leakage as shown in Figure 3-1. If the cap on the vial does not have a line, ensure the cap is tightened securely.

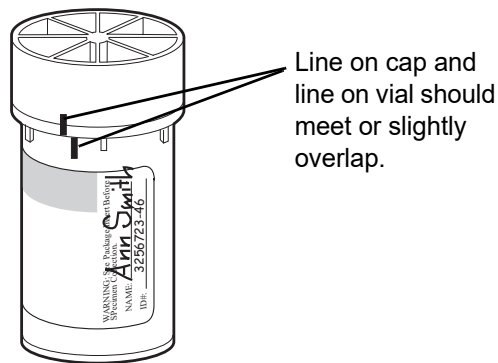

Figure 3-1 Aligning the vial cap

The shipping category for PreservCyt Solution is:

“flammable liquids, n.o.s. (methanol)” (USA only)

“flammable liquids, toxic, n.o.s. (methanol) (outside the USA)

The shipping category for PreservCyt Solution containing cells is “diagnostic sample.”

Please refer to the Shipping Requirements and Recommendations guide at the end of this chapter.

Stability

Do not use PreservCyt Solution after the expiration date on the container label. If making multiple slides from the same sample vial, be sure to make the slides before the expiration date marked on the

sample vial. Expired vials should be discarded using appropriate laboratory procedures. Also, refer to the storage requirements (page 3.1) for cell preservation limits.

Handling/Disposal

Handle all chemical-containing materials carefully in accordance with safe laboratory practices. When required by reagent composition, additional precautions are marked on the reagent containers or in the instructions for use.

Dispose of PreservCyt Solution according to the guidelines for disposing of hazardous waste. PreservCyt Solution contains methanol.

PreservCyt Solution was challenged with a variety of microbial and viral organisms. The following table presents the starting concentrations of viable organisms and the log reduction of viable organisms found after 15 minutes in the PreservCyt Solution. As with all laboratory procedures, universal precautions should be followed.

Organism	Initial Concentration	Log Reduction After 15 Minutes
<i>Candida albicans</i>	5.5 x 10 ⁵ CFU/ml	≥4.7
<i>Candida auris</i>	2.6 x 10 ⁵ CFU/ml	≥5.4
<i>Aspergillus niger</i>	4.8 x 10 ⁵ CFU/ml	2.7*
<i>Escherichia coli</i>	2.8 x 10 ⁵ CFU/ml	≥4.4
<i>Staphylococcus aureus</i>	2.3 x 10 ⁵ CFU/ml	≥4.4
<i>Pseudomonas aeruginosa</i>	2.5 x 10 ⁵ CFU/ml	≥4.4
<i>Mycobacterium tuberculosis</i> [†]	9.4 x 10 ⁵ CFU/ml	4.9**
Rabbitpox virus	6.0 x 10 ⁶ PFU/ml	5.5***
HIV-1	3.2 x 10 ⁷ TCID ₅₀ /ml	≥7.0***
Hepatitis B virus [†]	2.2 x 10 ⁶ TCID ₅₀ /ml	≥4.25
SARS-CoV-2 virus	1.8 x 10 ⁶ TCID ₅₀ /ml	≥3.75
* After 1 hour 4.7 log reduction ** After 1 hour 5.7 log reduction *** Data is for 5 minutes † Organisms were tested with similar organisms from the same genus to assess antimicrobial effectiveness		



PRESERVCYT® AND CYTOLYT® SOLUTIONS

Organism	Initial Concentration	Log Reduction After 15 Minutes
Note: All log reduction values with a \geq designation yielded undetectable microbial presence after exposure to PreservCyt Solution. The listed values represent the minimum allowable claim given the initial concentration and the detection limit of the quantitative method.		

Safety Data Sheet

The SDS for PreservCyt Solution is available at www.hologicsds.com.

Interfering Substances

The use of lubricants (e.g., KY Jelly) should be avoided prior to specimen collection. Lubricants can adhere to the filter membrane and may cause poor cell transfer to the slide. If its use is unavoidable, the lubricant should be carbomer-free and used in minimum amounts.

**SECTION
B****CYTOLYT[®] SOLUTION**

CytoLyt Solution is a methanol-based, buffered, preservative solution designed to lyse red blood cells, prevent protein precipitation, dissolve mucus, and preserve morphology of general cytology samples. It is intended as a transportation medium and is used in specimen preparation prior to processing. It is not intended for complete inactivation of microbes. Chapter 5, Non-Gynecologic Sample Preparation, describes the uses of CytoLyt Solution in detail.

Packaging

Please refer to the Ordering Information in this manual for part numbers and detailed information regarding the ordering of solutions and supplies for the ThinPrep[®] Genesis processor.

Composition

CytoLyt Solution contains methanol and buffer.

WARNING: Danger. CytoLyt Solution contains methanol. Harmful if swallowed. Harmful if inhaled. Causes damage to organs. Cannot be made non-poisonous. Keep away from heat, sparks, open flames and hot surfaces. Other solutions cannot be substituted for CytoLyt Solution.

Storage Requirements

- Store the containers at 15°C– 30°C without cells.
- Cells in CytoLyt Solution are preserved for 8 days at room temperature; however, for best results, transport specimen to the laboratory immediately for processing. This 8-day preservation period pertains to samples in a minimum CytoLyt Solution-to-sample ratio of one part CytoLyt Solution to three parts sample.
- Storage requirements for quantities of CytoLyt Solution are dependent on local regulations regarding the size and configuration of your facility. Please refer to the Solution Storage Guide at the end of this chapter.

Transportation

Make sure the tubes and specimen cups containing CytoLyt Solution are tightly sealed. Align the mark on the cap with the mark on the vial to prevent leakage.

Stability

Do not use CytoLyt Solution after the expiration date on the container label. Refer to the Storage Requirements earlier in this section for cell preservation limits.



PRESERV[®]CYT[®] AND CYTO[®]LYT[®] SOLUTIONS

Handling/Disposal

Handle all chemical-containing materials carefully in accordance with safe laboratory practices.

Safety Data Sheet

The SDS for CytoLyt Solution is available at www.hologicsds.com.

The National Fire Protection Association (NFPA) is the expert authority that local fire departments and fire safety code enforcement authorities look to for fire safety standards and codes. Their codes are developed through a consensus standards development process approved by the American National Standards Institute. The NFPA codes are used as guidelines by most fire code enforcement agencies. Since these codes are guidelines, your local Authority Having Jurisdiction (AHJ) for fire code enforcement may make the final determination. The summary chart below is based upon guidelines for facilities protected by standard sprinkler systems. ⁽³⁾

The ThinPrep products NFPA ratings are listed in a table below this chart.

Use this chart to help you determine your maximum storage limits for flammable and combustible liquids.

Maximum Quantities of Flammable and Combustible Liquids in Laboratory Units Outside of Inside Liquid Storage Areas⁽⁴⁾														
Lab Unit Fire Hazard Class	Flammable & Combustible Liquid Class	NFPA Code	Quantities in Use						Quantities in Use and Storage					
			Max per 100ft ² (9.2m ²) of Lab Unit ⁽⁵⁾			Max Quantity per Lab Unit			Max per 100ft ² (9.2m ²) of Lab Unit ⁽⁵⁾			Max Quantity per Lab Unit		
			Gallons	Liters	Vials ⁽⁸⁾	Gallons	Liters	Vials ⁽⁸⁾	Gallons	Liters	Vials ⁽⁸⁾	Gallons	Liters	Vials ⁽⁸⁾
A (High)	I	45-2015	10	38	1900	480	1820	91,000	20	76	3800	480	1820	91,000
	I, II, IIIA	45-2015	20	76	3800	800	3028	151,400	40	150	7500	1600	6060	303,000
B⁽⁶⁾ (Moderate)	I	45-2015	5	19	950	300	1136	56,800	10	38	1900	480	1820	91,000
	I, II, IIIA	45-2015	10	38	1900	400	1515	75,750	20	76	3800	800	3028	151,400
C⁽⁷⁾ (Low)	I	45-2015	2	7.5	375	150	570	28,500	4	15	750	300	1136	56,800
	I, II, IIIA	45-2015	4	15	750	200	757	37,8520	8	30	1500	400	1515	75,750
D⁽⁷⁾ (Minimal)	I	45-2015	1	4	200	75	284	14,200	2	7.5	375	150	570	28,500
	I, II, IIIA	45-2015	1	4	200	75	284	14,200	2	7.5	375	150	570	28,500

Maximum Quantities of PreservCyt Solution (Class IC) That Can Be Stored per Fire Area⁽⁹⁾ Outside a Safety Flammable Cabinet				
Location	NFPA Code	Gallons	Liters	Vials ⁽⁸⁾
General Warehouse ⁽¹⁰⁾⁽¹²⁾⁽¹³⁾	30-2015	120	460	23,000
Liquid Warehouse ^(3,11)	30-2015	Unlimited	Unlimited	Unlimited
Office, to include Exam Rooms	30-2015	10	38	1900

Allowable Quantities of PreservCyt Solution That Can Be Stored in a Liquid Storage Room				
Location	NFPA Code	Gallons	Liters	Vials ⁽⁸⁾
Maximum allowable storage per ft ² in an inside storage room that is smaller than 150ft ² in size.	30-2015	5	19	950
Maximum allowable storage per ft ² in an inside storage room that is larger than 150ft ² and less than 500ft ² in size.	30-2015	10	38	1900

- (1) Solution classifications: PreservCyt – Class IC; CytoLyt – Class II; CellFyx – Class IB
- (2) This information is Hologic’s summary of the various regulations. To view the codes in their entirety, please refer to NFPA 30 and NFPA 45.
- (3) A Liquid Warehouse shall have a sprinkler system that complies with the appropriate system indicated in NFPA 30.
- (4) An Inside Liquid Storage Area is a storage room totally enclosed within a building and having no exterior walls.
- (5) A Laboratory Unit is the area surrounded by firewalls per NFPA 30 *Flammable and Combustible Liquids Code*.
- (6) Reduce quantities by 50% for B laboratory units located above the 3rd floor.
- (7) Reduce quantities by 25% for C and D laboratory units located on the 4th-6th floors of a building and reduce quantities by 50% for C and D laboratory units above the 6th floor
- (8) 20ml PreservCyt vials.
- (9) A Fire Area is the area of a building separated from the remainder of the building by construction having a fire resistance of at least 1-hour and having all communicating openings properly protected by an assembly having a fire resistance rating of at least 1-hour per NFPA 30 *Flammable and Combustible Liquids Code*.

- (10) Allowable quantities in a warehouse can be increased with a sprinkler system rated higher than standard systems.
- (11) A Liquid Warehouse is a separate, detached building or attached building used for warehousing-type operations for liquids.
- (12) Quantities are permitted to be increased 100% where stored in approved flammable liquids storage cabinets.
- (13) Quantities are permitted to be increased 100% in buildings equipped throughout with an automatic sprinkler system installed in accordance with NFPA13, Standard for the Installation of Sprinkler Systems.

This table lists the NFPA ratings for all the ThinPrep products.

ThinPrep Product	Health Hazard	Flammability Hazard	Instability Hazard	Specific Hazard
ThinPrep PreservCyt Solution	2	3	0	N/A
ThinPrep CytoLyt Solution	2	2	0	N/A
ThinPrep CellFyx Solution	2	3	0	N/A
ThinPrep Rinse Solution	0	0	0	N/A
ThinPrep Bluing Solution	0	0	0	N/A
ThinPrep Rinse II Solution	2	3	0	N/A
ThinPrep Bluing II Solution	0	0	0	N/A
ThinPrep Stain EA Solution	2	3	0	N/A
ThinPrep Stain Orange G Solution	2	3	0	N/A
ThinPrep Nuclear Stain	2	0	0	N/A

ThinPrep® Solutions Shipping Requirements *

Scope:

These requirements include shipping:

- Biological specimens (patient specimens) in ThinPrep® solutions
- Biological specimens in solutions other than ThinPrep® solutions
- Biological specimens not in solutions
- ThinPrep® PreservCyt™ Solution without biological specimens
- ThinPrep® CytoLyt™ Solution without biological specimens

Note: Shippers of Hazardous Materials or Dangerous Goods must be trained according to the various Hazardous Materials/Dangerous Good regulations

A. Shipping Requirements when shipping patient samples in ThinPrep PreservCyt Solution only – Ambient Temperature:

1. Patient samples / biological substances (pathogens) contained ThinPrep PreservCyt Solution are neutralized or inactivated by the solution and as such no longer pose a health risk. (For further information regarding this, refer to the ThinPrep 2000 or ThinPrep 5000 Operators' Manual).
2. Materials that have been neutralized or inactivated are exempt from the Category B Class 6, Division 6.2 requirements.
3. Solutions that contain neutralized or inactivated pathogens, and meet the criteria of one or more of the other hazards risks, must be shipped according to the shipping requirements for that hazard risk(s).
4. ThinPrep PreservCyt Solution is a Flammable liquid when shipped domestic or international. Therefore, follow the instructions in Section C below, Shipping ThinPrep® PreservCyt™ Solution Only (such as from a laboratory to a physician).

B Shipping Biological Specimens in Solutions (other than ThinPrep PreservCyt Solution) or Without Solutions

Notes:

When biological specimens are shipped in a solution of a quantity of 30 ml or less and are packed in accordance with these guidelines, no further requirements in the Hazardous Materials (Dangerous Goods) Regulations need be met. However, training is recommended.”¹

Definitions:

- Biological Substance, Category B: Materials containing or suspected to contain infectious substances that do not meet Category A criteria. IATA Dangerous Goods regulations were revised with an effective date of January 1, 2015. Note: The term “diagnostic specimen” has been replaced with “biological substance, Category B”
- Exempt specimens: Specimens that with the minimal likelihood that pathogens are present (fixed tissue, etc.)

* These instructions are Hologic's interpretation of the various regulations as of the effective date. However, Hologic will not be responsible for any non-conformance to the actual regulations.

Shipping Requirements Category B or Exempt ¹ – Ambient Temperature:

1. Packaging must consist of three components
 - a. a primary receptacle, leak proof
 - b. secondary packaging, leak proof
 - c. a rigid outer packaging

NOTES:

- FedEx will not accept clinical samples or diagnostic specimens packaged in FedEx envelopes, FedEx tubes, FedEx Paks, or FedEx Boxes, Styrofoam boxes, plastic bags, or paper envelopes.
- FedEx will accept clinical samples in FedEx Clinical Paks, FedEx Medium Clinical Boxes or FedEx Large Clinical Boxes.²

2. The primary receptacle cannot contain more than 1L of a liquid substance (500 ml if using FedEx).
3. If multiple fragile primary receptacles are placed in a single secondary packaging, they must be either individually wrapped or separated to prevent contact between them.
4. Absorbent material must be placed between the primary receptacle and the secondary packaging. The absorbent material (cotton balls, cellulose wadding, absorbent packets, paper towels) must be in sufficient quantity to absorb the entire contents of the primary receptacle(s) so that any release of the liquid substance will not compromise the integrity of the cushioning material or the outer packaging.
5. The outer packaging must not contain more than 4L or 4kg of material. This quantity excludes ice, dry ice, or liquid nitrogen when used to keep specimens cold.
6. An itemized list of contents must be enclosed between the secondary packaging and the outer packaging.
7. The packaging must successfully pass a 4 ft. drop test (Section 6.6.1 IATA regulations).
8. The UN3373 mark must be displayed on the external surface of the outer packaging (one surface of the outer packaging must have a minimum dimension of 100 mm x 100 mm FedEx minimum is 7"x 4"x 2") on a background of a contrasting color and must be clearly visible and legible. The mark must be in the form of a diamond with each side having a length of at least 50 mm. Lettering must be at least 6mm high.
9. The proper shipping name "Biological Substance, Category B" in letters at least 6mm high must be marked on the outer package adjacent to the diamond shaped UN3373 mark.

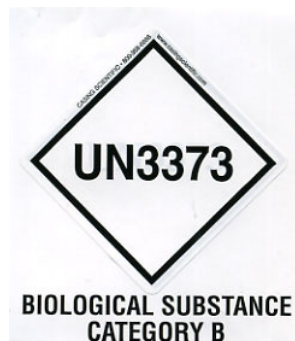

10. If using FedEx, the FedEx USA Airbill, Section 6, Special Handling must be completed with dangerous goods/dry ice information:

Does this shipment contain dangerous goods?

YES- Shipper's Declaration not required

11. The outer container of all diagnostic/clinical specimen packages must display the following:

- a. Sender's name and address
- b. Recipient's name and address
- c. The words "Biological Substance, Category B"
- d. The UN 3373 label

Shipping Requirements Category B or Exempt¹ – Frozen or Refrigerated Specimens:

NOTE: FedEx defers to IATA regulations for the shipping of refrigerated or frozen diagnostic specimens.²

Follow all packaging directions for Category B or Exempt – Ambient Temperature plus:

1. Place ice or dry ice outside of the secondary packaging. Interior supports must be provided to secure the secondary packaging in the original position after the ice or dry ice has dissipated. If ice is used, the outside packaging or overpack must be leak proof. If dry ice is used, the packaging must be designed and constructed to permit the release of CO² gas to prevent a buildup of pressure that could rupture the packaging.

2. Always affix the Class 9, UN 1845 dry ice label as well as the UN 3373, Biological Substance, Category B label to these shipments

3. If using FedEx, the FedEx USA Airbill, Section 6, Special Handling must be completed with dangerous goods/dry ice information:

Does this shipment contain dangerous goods?

YES- Shipper's Declaration not required

Enter kg of dry ice used (if applicable)

4. The outer container of all diagnostic/clinical specimen packages must display the following:
 - a. Sender's name and address
 - b. Recipient's name and address
 - c. The words "Biological Substance, Category B"
 - d. The UN 3373 label
 - e. Class 9 label, including UN 1845, and net weight if packaged with dry ice

C Shipping ThinPrep® PreservCyt™ Solution Only (such as from a laboratory to a physician)

Domestic Ground Shipments - Limited Quantities:

Notes:

ThinPrep® PreservCyt™ Solution is classified as a Class 3 Flammable liquid, assigned to Packing Group III (PG III).

49 CFR 173.150 (Limited Quantities) allows ThinPrep® PreservCyt™ Solution in vials to be shipped in Limited Quantities when shipped via ground transportation in a sturdy box. The total volume in a package cannot exceed 5 liters or weigh more than 30 kg (66 lbs). Limited Quantities are exempt from labeling requirements.

Limited Quantity domestic ground shipping recommendations:

1. ThinPrep® PreservCyt™ Solution must be shipped in the vials.
2. Place the vials in a good quality cardboard box, such as the ThinPrep® box that holds 250 vials. Pack vials in a manner (adding protective packing material as necessary) as to limit movement of individual vials.
3. Mark the package as “Flammable liquids, n.o.s., (Methanol Solution), 3, UN1993, Ltd. Qty.” add orientation arrows on the ends, and the Limited Quantity label:

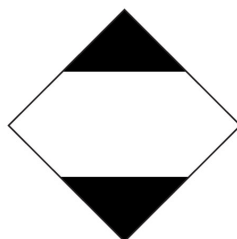

4. Print “UN1993, Flammable liquids, n.o.s., (Methanol Solution), 3, PG III, Ltd. Qty.” on the Shipping papers.

Domestic Ground Shipments - Other than Limited Quantities:

When shipping packages in excess of “Limited Quantity” amounts:

1. Do not include “Ltd Qty” in the wording on the package or on the Shipping papers as indicated in c and d above.
2. Affix a Class 3 “Flammable Liquid” hazard label to the outer package in close proximity of the wording described in “C” above. See the example of the label on the last page of these recommendations.
3. Mark the package as “Flammable liquids, n.o.s., (Methanol Solution), 3, UN1993, Net Qty.”

Domestic Air Shipments:

In addition to 1 and 2 above in Domestic Ground Shipments – Other than Limited Quantities, the following are recommendations for domestic air shipments:

3. Maximum allowable package sizes are:
 - i. Sixty (60) liters (3000-vials) for passenger aircraft, and
 - ii. Two hundred twenty (220) liters (11,000-vials) for cargo aircraft.

4. Single packages containing more than sixty (60) liters (3000-vials) of total product must be clearly marked "FOR CARGO AIRCRAFT ONLY".
5. The vials must be shipped in United Nations (UN) certified 4G packaging for any quantity in an aircraft. (e.g., ThinPrep® PreservCyt™ Solution 250-vial box or equivalent.)
6. A Class 3 "Flammable Liquid" label must be affixed to the outer package near the words "Flammable liquids, n.o.s., (Methanol Solution)".



All Domestic Shipments:

The following are recommendations for all domestic ground and air shipments:

1. If the ThinPrep® PreservCyt™ Solution is shipped in a package also containing non-hazardous material, the hazardous material must be listed first, or be printed in a contrasting color (or highlighted) to differentiate it from the non-hazardous material.
2. The total volume of ThinPrep® PreservCyt™ Solution and the number of vials must appear on the shipping papers.

International Ground Shipments - Limited Quantities:

When shipping internationally, ThinPrep® PreservCyt™ Solution is classified with a primary hazard of Class 3 (Flammable Liquid), and with a secondary hazard of Class 6.1 (Toxic). It is assigned to PG III.

The reference used for the international ground recommendations is the *ADR - European Agreement Concerning the International Carriage of Dangerous Good by Road* (United Nations). A "Limited Quantity" is defined as a package containing a maximum net quantity of 5-liters and not weighing more than 20 kg (40 lbs). The recommendations for international ground shipments are as follows:

1. ThinPrep® PreservCyt™ Solution must be shipped in the vials.
2. Place the vials in a good quality cardboard box, such as the Cytyc box that holds 250 vials. Pack vials in a manner (adding protective packing material as necessary) as to limit movement of individual vials.
3. Mark the package with "UN1992, Flammable liquids, toxic, n.o.s., (Methanol Solution), 3, 6.1, PGIII Ltd. Qty" orientation arrows on the ends and the Limited Quantity label that has a "Y" on it.

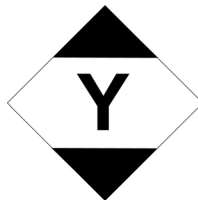

4. The shipping papers should include all the information indicated in "3" above.

International Ground Shipments – Other than Limited Quantities:

1. Do not include “Ltd Qty” in the wording on the package or on the Shipping papers as indicated in c and d above.
2. Affix both a Class 3 “Flammable Liquid” label and a secondary Class 6.1 “Toxic” label to the package adjacent to the markings. (Copies of the labels can be found on the last page of this document.)



Class 6.1 “Toxic” secondary hazard label.

3. Mark the package with “UN1992, Flammable liquids, toxic, n.o.s., (Methanol Solution), 3, 6.1, PG III, Net Qty”.

International Air Shipments:

The references used for the International Air recommendations are: In addition to a and b above in International Ground Shipments, the following are the recommendations for international air shipments:

1. Maximum allowable package sizes are:
 - i. Sixty (60) liters (3000-vials) for passenger aircraft, and
 - ii. Two hundred twenty (220) liters (11,000-vials) for cargo aircraft.
2. Packages containing more than sixty (60) liters of product must be clearly marked “FOR CARGO AIRCRAFT ONLY”
3. The vials must be shipped in United Nations (UN) certified 4G packaging for any quantity in an aircraft. (e.g., ThinPrep® PreservCyt™ Solution 250-vial box or equivalent.) Pack vials in a manner (adding protective packing material as necessary) as to limit movement of individual vials.
4. Limited Quantity exemption can only be used if the package has a maximum net quantity of 2-liters.
5. Packaging manufacturer’s specifications markings are not required when shipping Limited Quantity.
6. Mark the package with “UN1992, Flammable liquids, toxic, n.o.s., (Methanol Solution), 3, 6.1, PGIII, Net. Qty”.
7. When a “Cargo Aircraft Only” marking is required, it must be affixed on the same package surface and near the hazard labels.
8. The shipper is responsible for the completion of a “Shipper’s Declaration for Dangerous Goods” form.

D. Shipping ThinPrep® CytoLyt™ Solution Only (such as from a laboratory to a physician)

Domestic Ground Shipments:

ThinPrep® CytoLyt™ Solution has a flash point of 109° F. For domestic ground transportation only, a flammable liquid with a flashpoint at or above 100° F that does not meet the definition of any other hazard class may be reclassified as a combustible liquid. As such, ThinPrep® CytoLyt™ Solution, shipped via ground, is exempt from the requirements of the DOT Hazardous Materials Regulations.

Domestic Air Shipments:

When shipping ThinPrep® CytoLyt™ Solution via air, follow the Domestic Air Shipments recommendations for Shipping ThinPrep® PreservCyt™ Solution Only that can be found in Section C of this document.

International Ground and Air shipments:

When shipping ThinPrep® CytoLyt™ Solution via ground or air, follow the International Ground or Air Shipments recommendations for Shipping ThinPrep® PreservCyt™ Solution Only guidelines that can be found in Section C of this document.

E. Shipping ThinPrep® CytoLyt™ Solution With Patient Sample (such as from a physician to a laboratory)

Domestic Shipments:

ThinPrep® CytoLyt™ Solution containing a patient sample is classified as a Biological Substance, Category B. Follow the recommendations in Section B of this document.

International Shipments:

ThinPrep® CytoLyt™ Solution containing a patient sample is classified as a Biological Substance, Category B. Follow the recommendations in Section B of this document.

References:

- 49 CFR 100 to 185, *Transportation*
- *Dangerous Goods Regulations*, 56th Edition, 2015, International Air Transportation Association (IATA)
- International Civil Aviation Organization's (ICAO) *Technical Instructions for the Safe Transport of Dangerous Goods by Air*

Foot Notes:

1. See Packing Instruction 650 in the IATA *Dangerous Goods Regulations*
2. FedEx Document 33539PL: "Packaging Clinical Samples" and "Packaging UN 3373 Shipments"

**4. Gynecologic
Sample Preparation**

**4. Gynecologic
Sample Preparation**

Chapter Four

Gynecologic Sample Preparation

**SECTION
A**

INTRODUCTION

Includes cell samples from the ectocervix and the endocervix.

	<p>1. Collection: Deposit the specimen directly into a PreservCyt[®] Solution vial.</p> <p>Note: Proper rinsing technique of the collection device is very important. See specimen collection instructions on pages 4.3 and 4.4.</p>
	<p>2. Allow to stand in PreservCyt Solution for 15 minutes</p>
	<p>3. Run on ThinPrep[®] Genesis processor using the Slide or Aliquot + Slide process.</p>



GYNECOLOGIC SAMPLE PREPARATION

SECTION B

COLLECTION PREPARATION

ThinPrep Collection Techniques

The detection of cervical cancer and its precursors as well as other gynecologic abnormalities is the primary purpose of obtaining a cervical cell sample. The following guidelines are referenced from Clinical and Laboratory Standard Institute Guidelines, (CLSI) Document GP15-A3¹ and are recommended in the collection process for obtaining a ThinPrep Pap test (TPPT) specimen. In general, the guidelines state that it is important to obtain a specimen that is not obscured by blood, mucus, inflammatory exudate or lubricant.

Patient Information

- The patient should be tested 2 weeks after the first day of her last menstrual period, and avoid scheduling her appointment during heavy menstrual bleeding.²
Even though the TPPT reduces obscuring blood, clinical studies have demonstrated that excessive amounts of blood may still compromise the test and possibly lead to an unsatisfactory result.³
- The patient should not use vaginal medication, vaginal contraceptives, or douches during the 48 hours before the exam.

1. Papanicolaou Technique Approved Guidelines (CLSI Document GP15-A3, third edition, 2008)

2. Davey et al. Cervical Cytology Specimen Adequacy: Patient Management Guidelines and Optimizing Specimen Collection. American Society for Colposcopy and Cervical Pathology Journal of Lower Genital Tract Disease, Volume 12, Number 2, 2008, 71-81

3. Lee et al. Comparison of Conventional Papanicolaou Smears and Fluid-Based, Thin-Layer System for Cervical Cancer Screening. Ob Gyn 1997; 90: 278-284.

Specimen Collection Preparation

- Lukewarm water may be used to warm and lubricate the speculum.
- If lubricant must be used due to patient discomfort or other circumstances, carbomer-free lubricant jellies should be used sparingly, applied only to the exterior sides of the speculum blades.

Even though lubricant jellies are water soluble, excessive amounts of jelly may compromise the test and possibly lead to an unsatisfactory result.

- Remove excess mucus or other discharge present before taking the sample. This should be gently removed with ring forceps holding a folded gauze pad.

The excess cervical mucus is essentially devoid of meaningful cellular material and when present in the sample vial may yield a slide with little or no diagnostic material present.

- Remove inflammatory exudate from the cervical canal before taking the sample. Remove by placing a dry 2 x 2 inch (5 x 5 cm) piece of gauze over the cervix and peeling it away after it absorbs the exudate or by using a dry procto swab or Scopette[®] swab.

The excess inflammatory exudate is essentially devoid of diagnostic cellular material and when present in the sample vial may yield a slide with little or no diagnostic material present.

- The cervix should not be cleaned by washing with saline or it may result in a relatively acellular specimen.
- The sample should be obtained before the application of acetic acid.

4







GYNECOLOGIC SAMPLE PREPARATION

SECTION C

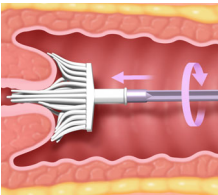
SPECIMEN COLLECTION

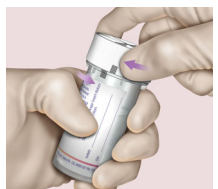
Collect Gynecologic Sample Using the Broom-Like Device

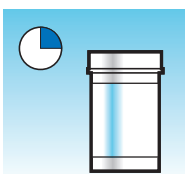
Physician/clinician instructions for collecting gynecologic samples.

	<p>1. Obtain an adequate sampling from the cervix using a broom-like device. Insert the central bristles of the broom into the endocervical canal deep enough to allow the shorter bristles to fully contact the ectocervix. Push gently, and rotate the broom in a clockwise direction five times.</p>
	<p>2. Rinse the broom as quickly as possible into the PreservCyt Solution vial by pushing the broom into the bottom of the vial 10 times, forcing the bristles apart. As a final step, swirl the broom vigorously to further release material. Discard the collection device.</p>
	<p>3. Tighten the cap so that the torque line on the cap passes the torque line on the vial.</p>
	<p>4. Record the patient's name and ID number on the vial. Record the patient information and medical history on the cytology request form.</p>
	<p>Note: If the sample is to be processed immediately, allow the sample to stand in the PreservCyt Solution vial for at least 15 minutes before processing. If the sample is to be sent elsewhere for processing, continue with the next step.</p>
	<p>5. Place the vial and requisition in a specimen bag for transport to the laboratory.</p>

Refer to the instructions provided with the collection device for warnings, contraindications, and limitations associated with specimen collection.



Collect Gynecologic Sample, Using the Endocervical Brush/Spatula Device

Physician/clinician instructions for collecting gynecologic samples.

	<p>1. Obtain an adequate sampling from the ectocervix using a <i>plastic spatula</i>.</p>
	<p>2. Rinse the spatula as quickly as possible into the PreservCyt Solution vial by swirling the spatula vigorously in the vial 10 times. Discard the spatula.</p>
	<p>3. Obtain an adequate sampling from the endocervix using an endocervical brush device. Insert brush into the cervix until only the bottom-most fibers are exposed. Slowly rotate 1/4 or 1/2 turn in one direction. DO NOT OVER-ROTATE.</p>
	<p>4. Rinse the brush as quickly as possible in the PreservCyt Solution by rotating the device in the solution 10 times while pushing against the PreservCyt vial wall. Swirl vigorously to further release material. Discard the brush.</p>
	<p>5. Tighten the cap so that the torque line on the cap passes the torque line on the vial.</p>
	<p>6. Record the patient's name and ID number on the vial. Record the patient information and medical history on the cytology requisition form.</p>

4

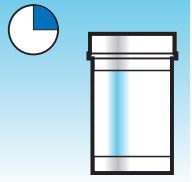
GYNECOLOGIC SAMPLE PREPARATION

	<p>Note: If the sample is to be processed immediately, allow the sample to stand in the PreservCyt Solution vial for at least 15 minutes before processing.</p> <p>If the sample is to be sent elsewhere for processing, continue with the next step.</p>
	<p>7. Place the vial and requisition in a specimen bag for transport to the laboratory.</p>

Refer to the instructions provided with the collection device for warnings, contraindications, and limitations associated with specimen collection.

SECTION
D

SPECIAL PRECAUTIONS

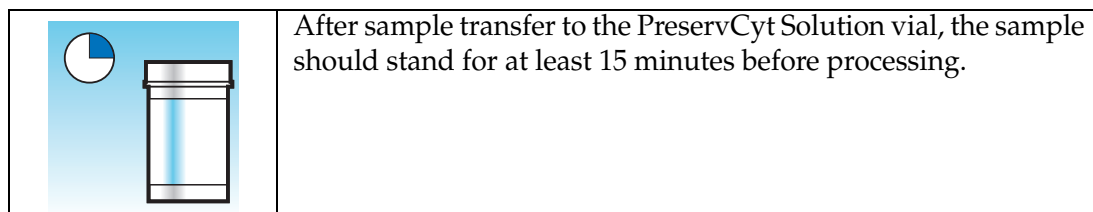
PreservCyt Solution

After sample transfer to the PreservCyt Solution vial, the sample should stand for at least 15 minutes before processing.

For more information on PreservCyt Solution, refer to Chapter 3, “PreservCyt® and CytoLyt® Solutions”.

Interfering Substances

The Clinical and Laboratory Standard Institute Guidelines recommend that no lubricant be used during Pap testing.¹

ACOG recommends that care be taken not to contaminate the specimen with lubricant because this may lead to unsatisfactory results.² This applies to both conventional Pap testing and liquid based cytology.

If you are using a plastic speculum, or in instances where a lubricant must be used, take care not to contaminate the cervix or collection devices with the lubricant. A tiny amount of carbomer-free lubricant may be used, just enough to sparingly coat the speculum with a gloved finger, avoiding the tip of the speculum.

The Clinical and Laboratory Standard Institute Guidelines and ACOG recommend that you not take a Pap during menses.¹⁻²

For samples to be processed on the ThinPrep processor, lubricants can adhere to the filter membrane and may cause poor cell transfer to the slide. If the use of lubricant is unavoidable, the carbomer-free lubricant should be used in minimum amounts.

1. Papanicolaou Technique Approved Guidelines (CLSI Document GP15-A3, third edition, 2008)

2. ACOG Practice Bulletin, no. 45, August 2003

4

GYNECOLOGIC SAMPLE PREPARATION

Handling/Disposal

Handle all chemical-containing materials carefully in accordance with safe laboratory practices. When required by reagent composition, additional precautions are marked on the reagent containers.

Dispose of PreservCyt Solution according to your guidelines for disposing of hazardous waste. PreservCyt Solution contains methanol.

SECTION E

SPECIMEN PROCESSING

Materials Required

Refer to “Materials Required” on page 1.6 for a list and explanation of materials provided and materials required but not provided.

Specimen Preparation

- The gynecologic sample should be deposited in the PreservCyt Solution immediately upon collection.
- The PreservCyt Sample vial fluid level should be within the frosted area of the sample vial.

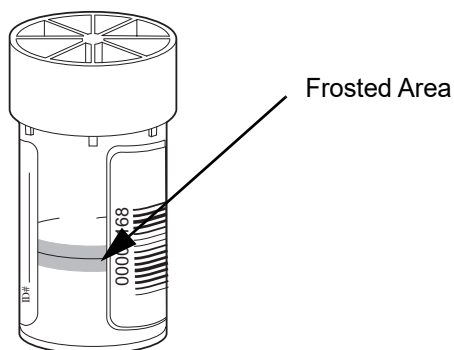
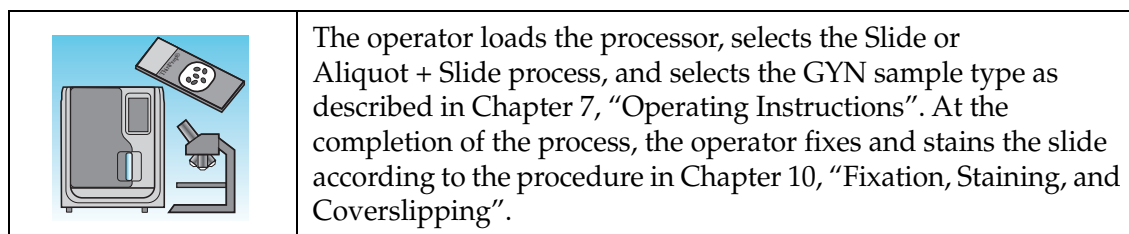

Figure 4-1 PreservCyt Solution sample vial fluid level

- Store PreservCyt Solution *with* cytologic sample intended for ThinPrep Pap testing between 15°C (59°F) and 30°C (86°F) for up to 6 weeks.

Run on ThinPrep® Genesis Processor Using the Slide or Aliquot + Slide Process



Stability

Store PreservCyt Solution *with* cytologic sample intended for ThinPrep Pap testing between 15°C (59°F) and 30°C (86°F) for up to 6 weeks.

SECTION F

SAMPLE PROCESSING TROUBLESHOOTING

Reprocessing a ThinPrep Pap test sample vial following an unsatisfactory result on a slide

Laboratory personnel may reprocess ThinPrep Pap test specimens where slides have been interpreted as inadequate (“Unsatisfactory for Evaluation”) for diagnosis following cytotechnologist screening. The instructions below must be followed in order to properly reprocess these specimens:

Note: For a specimen that will be used on a microscope slide, reprocessing a ThinPrep Pap test specimen may only be performed once.



Note: Good laboratory practices should be followed to avoid introducing contaminants into the PreservCyt Solution sample vial.

Removal of an aliquot after a sample has been reprocessed has not been validated on the ThinPrep Genesis processor.

4

GYNECOLOGIC SAMPLE PREPARATION

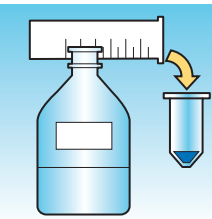
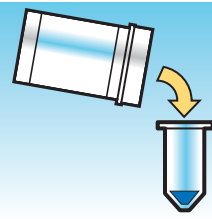
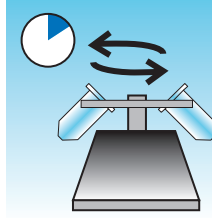
Reprocessing protocol

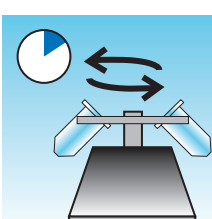
	<p>1 Prepare a wash solution of sufficient volume to add 30 ml to every ThinPrep Pap test specimen being reprocessed. The wash solution is made by mixing 9 parts CytoLyt Solution with 1 part glacial acetic acid.</p>
	<p>2 Prior to performing this step, assure there is sufficient volume in the ThinPrep Pap test specimen to result in a pellet, following centrifugation. Pour the contents of the ThinPrep Pap test specimen into a centrifuge tube appropriately labeled to maintain chain of custody. Retain the vial.</p>
	<p>3 Pellet the contents of the centrifuge tube by centrifugation at 1200 x g for 5 minutes.</p> <p>Note: Once centrifugation is complete, the cell pellet should be clearly visible but the cells may not be tightly packed together (the pellet may appear fluffy).</p>
 <p>30 ml</p>	<p>4</p> <ol style="list-style-type: none"> Carefully pour off the supernatant from the centrifuge tube to avoid loss of cells. Dispose of according to local regulations. Vortex the centrifuge tube briefly. Pour 30 ml of the CytoLyt Solution and 10% glacial acetic acid mixture into the centrifuge tube and cap securely. Invert the centrifuge tube by hand several times to mix.
	<p>5 Pellet the cells again by centrifugation - 1200 x g for 5 minutes.</p>

	<p>6</p> <ol style="list-style-type: none"> Carefully pour off the supernatant from the centrifuge tube to avoid loss of cells. Dispose of according to local regulations. Vortex the centrifuge tube briefly.
	<p>7</p> <ol style="list-style-type: none"> Using the volume markings on the centrifuge tube, pour the necessary quantity of unused (i.e., containing no patient specimens) PreservCyt Solution to the cells and fill to a final volume of 20 ml. Secure the cap tightly. Invert the centrifuge tube several times to mix and transfer the sample back into the retained specimen vial.
	<p>8</p> <p>Process the specimen using a ThinPrep Genesis processor according to the procedure for running gynecologic specimens. Evaluate the resultant slide according to <i>The Bethesda System for Reporting Cervical Cytology</i>. If after reprocessing, negative results from specimen do not fit with the clinical impression, a new specimen may be necessary.</p>



GYNECOLOGIC SAMPLE PREPARATION

This page intentionally left blank.

**5. Non-Gynecologic
Sample Preparation**

**5. Non-Gynecologic
Sample Preparation**

Chapter Five

Non-Gynecologic Sample Preparation

SECTION A

INTRODUCTION

This chapter provides instructions for preparing non-gynecologic (non-gyn) samples and making slides with the ThinPrep® Genesis System. Non-gyn specimens include, but are not limited to: fine needle aspirates, urines, effusions, sputa, respiratory tract, gastrointestinal tract, etc.

For the best results, carefully follow the instructions in this chapter. Because there is biological variability among samples and variability in collection methods, standard processing may not always yield a satisfactory and uniformly distributed preparation on the first slide. This chapter contains troubleshooting instructions for further sample processing to obtain better quality subsequent slides in these cases. This chapter also provides an outline of various sample collection methods and the appropriate procedures for each.

In order to perform sample preparation for ThinPrep UroCyte® specimens, refer to “Urine Specimens for the Vysis™ Urovysion Assay” on page 5.22. Sample preparation troubleshooting as described in “Sample Preparation Troubleshooting” on page 5.24 has not been evaluated for ThinPrep UroCyte samples.



NON-GYNECOLOGIC SAMPLE PREPARATION

SECTION B

CONTENTS

This chapter is divided into the following five main sections and several sub-sections:

SECTION C: Required Materials

SECTION D: Details of non-gynecologic sample preparation steps

SECTION D-1: Collection

SECTION D-2: Concentrate by Centrifugation - 600g for 10 Min.

SECTION D-3: Pour Off Supernatant and Vortex to Resuspend Cell Pellet

SECTION D-4: Evaluate Cell Pellet Appearance

SECTION D-5: Add Specimen to PreservCyt® Solution Vial

SECTION D-6: Allow to Stand in PreservCyt Solution for 15 Min.

SECTION D-7: Run on ThinPrep® Genesis processor. Fix, Stain, and Evaluate

SECTION D-8: Mechanical Agitation

SECTION D-9: CytoLyt® Solution Wash

SECTION E: Specimen Preparation Recommendations

SECTION E-1: Fine Needle Aspirates

SECTION E-2: Muroid Specimens

SECTION E-3: Body Fluids

SECTION E-4: Other Sample Types

SECTION F: Urine Specimens for the Vysis™ UroVysion Assay

SECTION G: Sample Preparation Troubleshooting

SECTION
C

REQUIRED MATERIALS

To perform further testing on an aliquot removed from the patient sample by the ThinPrep Genesis processor, additional materials may be required. Follow the instructions provided by the manufacturer of that assay for information describing any further testing.

The following materials are required for slide preparation of non-gynecologic samples on the ThinPrep Genesis processor.

From Hologic:

- CytoLyt Solution
 - CytoLyt tubes
 - CytoLyt cups
 - CytoLyt bottles (bulk)
- PreservCyt Solution
 - PreservCyt vials
 - PreservCyt bottles (bulk)
- Non-Gyn ThinPrep filters (blue)
- ThinPrep UroCyte[®] filter (yellow) for urine specimens (including the UroVysion assay urine specimens)
- ThinPrep UroCyte microscope slides for urine specimens (including the UroVysion assay urine specimens)
- ThinPrep UroCyte PreservCyt vials for urine specimens (including the UroVysion assay urine specimens)
- Non-Gyn ThinPrep microscope slides
- ThinPrep Genesis processor
- Vortexor

Note: Refer to the Ordering Information of the ThinPrep Genesis Processor Operator's Manual for more information about supplies and solutions from Hologic.

From Other Suppliers:

- 50 ml capacity centrifuge (free swing basket)
- Centrifuge tubes, 50 ml
- Plastic transfer pipettes, 1 ml
- Balanced electrolyte solutions
- Slide staining system and reagents
- Standard laboratory fixative

5

NON-GYNECOLOGIC SAMPLE PREPARATION



- Coverslips and mounting media
- Anticoagulant for needle aspirates
- Blender (optional)
- Glacial acetic acid (*troubleshooting only*)
- Saline (*troubleshooting only*)
- DiThioThreitol (DTT, optional, mucoid samples only)

SECTION D

DETAILS OF NON-GYNECOLOGIC SAMPLE PREPARATION STEPS

The following are the common steps for preparing a non-gynecologic sample with the ThinPrep Genesis processor. Each step is explained in detail in the following sections.

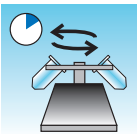
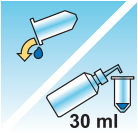
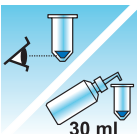
WARNING: Do not process a cerebral spinal fluid (CSF) specimen or other sample type that is suspected of possessing prion infectivity (PrPsc) derived from a person with a TSE, such as Creutzfeldt-Jakob disease, on the ThinPrep processor. A TSE-contaminated processor cannot be effectively decontaminated and therefore must be properly disposed of in order to avoid potential harm to users of the processor or service personnel.

	D-1. Collection
	D-2. Concentrate by centrifugation — 600g for 10 minutes
	D-3. Pour off supernatant and vortex to resuspend cell pellet
	D-4. Evaluate cell pellet appearance Refer to page 5.11.
	D-5. Add appropriate amount of specimen to PreservCyt Solution vial Refer to page 5.12.

	<p>D-6. Allow to stand in PreservCyt Solution for 15 minutes</p>
	<p>D-7. Run on ThinPrep® Genesis processor using the Slide or Aliquot + Slide process. Fix, stain, and evaluate</p>
	<p>D-8. Mechanical agitation (mucoid samples only, optional)</p>
	<p>D-9. CytoLyt Solution wash (Some specimens do not require a CytoLyt wash. Refer to the specific specimen preparation protocol.)</p>

SECTION D-1 COLLECTION

Note: The ThinPrep® Genesis processor is designed for use with PreservCyt® Solution. Do not run any other collection media or preservative solution through it.

Samples to be processed on the ThinPrep processor will arrive in the lab either fresh or in CytoLyt Solution. There are preferred collection methods for different sample types. This section will describe the Hologic recommended procedure as well as alternate collection methods.

WARNING: For washes and lavages, do not expose the patient to CytoLyt Solution.



Fine needle aspirate specimens:

The optimal collection technique for FNAs is to deposit and rinse the entire sample into a centrifuge tube containing 30 ml of CytoLyt Solution. A secondary method would be to collect the sample into a balanced electrolyte solution, such as Polysol® or Plasma-Lyte® injection solutions.

Note: Direct smears may be necessary for radiologic-guided FNAs when a rapid analysis of specimen adequacy is required.

5

NON-GYNECOLOGIC SAMPLE PREPARATION



Mucoid specimens:

Mucoid specimens are best collected into CytoLyt Solution. If they are collected fresh, CytoLyt Solution should be added as soon as possible. Early addition of CytoLyt Solution preserves the sample and initiates the mucus dissolution process.

Large volume of fresh mucoid specimens (greater than 20 ml) should be concentrated before addition of CytoLyt Solution to the sample.



Fluid specimens:

The preferred method for preparing fluid samples (urinary tract, effusions, synovial, and cyst fluids) is to concentrate the fresh sample before any addition of CytoLyt Solution. If this is not possible and the samples must be preserved for transport to the lab, collect the samples in CytoLyt Solution.

CytoLyt Solution added directly to fluids with high levels of protein may produce some degree of protein precipitation.

Note: Fluid collection in CytoLyt Solution is only considered a collection step and not a wash step. See “CytoLyt Solution Wash” on page 5.15, in this section for more detail.

The quantity of fluid samples can vary widely from less than 1 ml to 1000 ml and more. Each lab must follow its own procedure for determining the amount of sample to use for processing. If more than one centrifuge tube of sample is used, the cell pellets can be combined after pouring off the supernatant.



Other sample types:

For other sample types that are received in PreservCyt[®] Solution, such as brushings and scrapings, the sample is ready to be run on the ThinPrep[®] Genesis processor.

For other sample types that are received in CytoLyt Solution, follow the protocol for FNA samples. See “Fine Needle Aspirates (FNA)” on page 5.17.

Other collection media:

In cases where CytoLyt Solution is contraindicated, balanced electrolyte solutions, such as Plasma-Lyte and Polysol, may be used as collection media for samples to be processed on the ThinPrep Genesis processor. These solutions are primarily used as media for washings or lavages which contact the patient.

Non-recommended collection media:

Hologic does not recommend the use of the following collection solutions with the ThinPrep System. Use of these solutions will produce sub-optimal results:

- Sacomanno and other solutions containing carbowax
- Alcohol
- Mucollexx[®]
- Normal Saline
- Culture media, RPMI Solution
- PBS
- Solutions containing formalin

Specimens *must* be centrifuged and washed in CytoLyt[®] Solution and transferred to PreservCyt[®] Solution prior to being processed on the ThinPrep Genesis processor.

Refer to “CytoLyt Solution Wash” on page 5.15 for CytoLyt Solution wash instructions.

Note: See Chapter 3, PreservCyt[®] and CytoLyt[®] Solutions for more information on CytoLyt Solution.

WARNING: CytoLyt Solution is a poison (contains methanol) and it must never come in direct contact with the patient.

5

NON-GYNECOLOGIC SAMPLE PREPARATION

SECTION D-2

CONCENTRATE BY CENTRIFUGATION - 600 G FOR 10 MINUTES

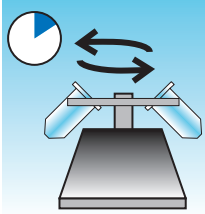

The purpose of this procedure is to concentrate the cellular material in order to separate the cellular component(s) from the supernatant. This step is performed with fresh samples and after the addition of CytoLyt Solution. When specified in the protocol, centrifuge samples at 600 times normal gravity (600 g) for 10 minutes to force the cells in solution into a pellet at the bottom of the centrifuge tube.

Set your centrifuge to the approximate number of revolutions per minute (rpm) to spin the cells at 600 g.

Follow these steps to determine the correct setting for your centrifuge:

Caution: Check cell morphology on non-critical experimental samples before making any changes to your centrifugation process.

Note: Use of fixed-angle centrifuges is not recommended.

Measure the rotor length of your centrifuge

Use a centimeter ruler to measure the radius of your centrifuge, the distance from the center of the rotor to the bottom of the bucket extended horizontally as shown in Figure 5-1.

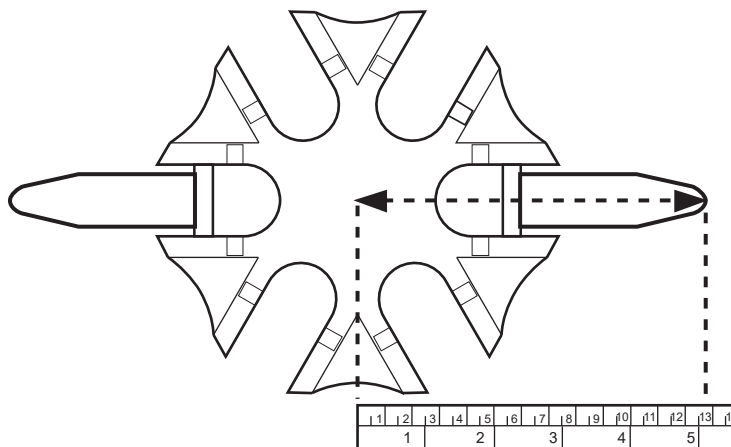

Figure 5-1 Measuring the centrifuge

Determine the correct centrifuge speed

Refer to the chart in Figure 5-2. Find the radius of your centrifuge in the first column of Figure 5-2. Draw a line from the radius value through the 600 Gravities (g) column and into the rpm column. Read the rpm value from the straight edge as shown in Figure 5-2. Run your centrifuge at this speed to achieve a force of 600 g on your samples.

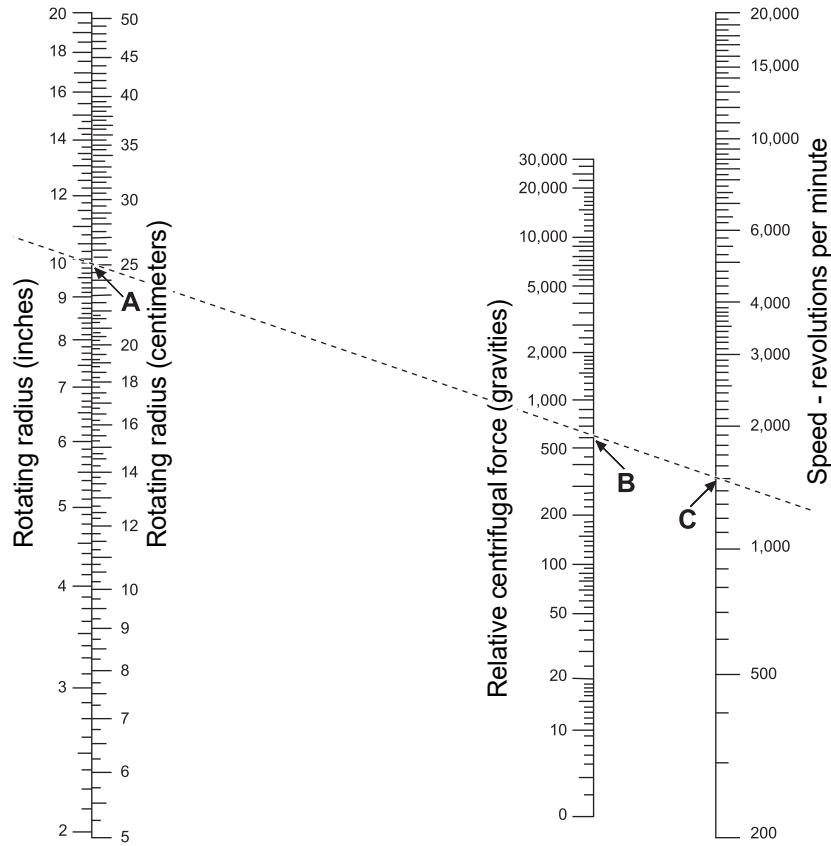

Figure 5-2 Determining the correct centrifuge speed

To reduce the time required for the centrifugation step, operate your centrifuge at 1200 g for 5 minutes.

5

NON-GYNECOLOGIC SAMPLE PREPARATION

SECTION D-3

POUR OFF SUPERNATANT AND VORTEX TO RESUSPEND CELL PELLET

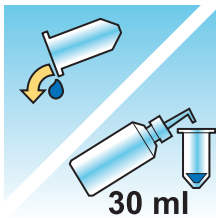

Pour off the supernatant completely to effectively concentrate the sample. To do this, invert the centrifuge tube 180 degrees in one smooth movement, pour off all the supernatant, and then return the tube to its original position as shown in Figure 5-3.¹ Observe the cell pellet during inversion to avoid accidental loss of cellular material.

Caution: Failure to completely pour off the supernatant may produce a sparse sample and an unsatisfactory slide due to dilution of the cell pellet.

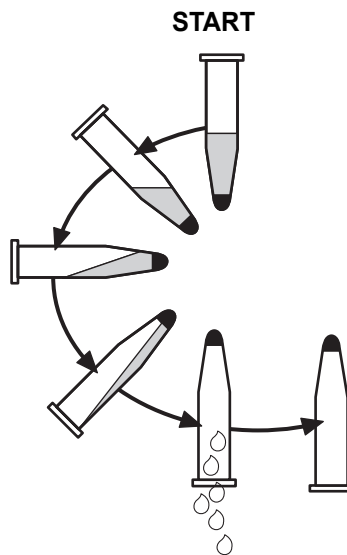

Figure 5-3 Pouring off supernatant

After pouring off the supernatant, place the centrifuge tube onto a vortexor and agitate the cell pellet for 3 seconds. Manual vortexing may be achieved by syringing the pellet back and forth with a plastic pipette. The intention of this vortexing step is to randomize the cell pellet before transferring to the PreservCyt Solution vial and to improve the results of the CytoLyt Solution washing procedure.

1. Refer to Bales, CE, and Durfee, GR. *Cytologic Techniques* in Koss, L. ed. *Diagnostic Cytology and its Histopathologic Basis*. 3rd Edition. Philadelphia: JB Lippincott. Vol. II: pp. 1187–12600 for details.

**SECTION
D-4**

EVALUATE CELL PELLETT APPEARANCE

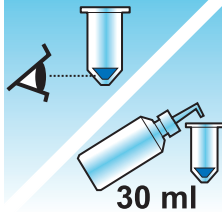

Appearance of Cell Pellet	Procedure
<p>Cell pellet is white, pale pink, tan, or not visible.</p>	<p>Add specimen to PreservCyt Solution vial. See “Add Specimen to PreservCyt Solution Vial” on page 5.12.</p>
<p>Cell pellet is distinctly red or brown indicating the presence of blood.</p>	<p>CytoLyt Solution wash See “CytoLyt Solution Wash” on page 5.15.</p> <ul style="list-style-type: none"> • Add 30 ml CytoLyt Solution • Concentrate by centrifugation • Pour off supernatant and vortex to resuspend cell pellet
<p>Cell pellet is mucoid (not in liquid form). To test for liquid form, draw a small amount of the sample into a pipette and deliver drops back into the tube. If the drops appear stringy or gelatinous, then the mucus must be further liquefied.</p>	<p>CytoLyt Solution wash See “CytoLyt Solution Wash” on page 5.15.</p> <ul style="list-style-type: none"> • Add 30 ml CytoLyt Solution • Mechanical agitation • Concentrate by centrifugation • Pour off supernatant and vortex to resuspend cell pellet

5



NON-GYNECOLOGIC SAMPLE PREPARATION

SECTION D-5

ADD SPECIMEN TO PRESERVCYT SOLUTION VIAL



Determine the cell pellet size and refer to the table below:

	Size of Cell Pellet	Procedure
	Pellet is clearly visible and the pellet volume is less than 1 ml.	Place the centrifuge tube in a vortexor to resuspend the cells in the residual liquid or mix the pellet by syringing it manually with a pipette. Transfer 2 drops of the pellet to a fresh PreservCyt Solution vial.
	Pellet is not visible or is scant.	Add the contents of a fresh PreservCyt Solution vial (20 ml) into the tube. Vortex briefly to mix the solution and pour the entire sample back into the PreservCyt Solution vial.
	Pellet volume is greater than 1 ml.	Add 1ml of CytoLyt Solution into the tube. Vortex briefly to resuspend the pellet. Transfer 1 drop of the specimen to a fresh PreservCyt Solution vial.

Factors to Consider

The type of pipette that you use may affect the concentration of the sample that is added to the PreservCyt Solution vial, and therefore may affect the volume of sample. Hologic recommends using standard, 1 ml plastic pipettes.

If a “Sample Is Dilute” message occurs repeatedly and specimen remains in the specimen tube, increase the number of drops of concentrated sample added to the vial.

Your technique for pouring off the supernatant may also affect the concentration of the sample. If the supernatant is not completely poured off, then additional drops of the sample may be required. The total volume added to the vial must not exceed 1 ml.

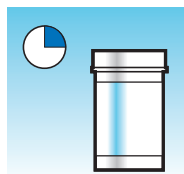
**SECTION
D-6****ALLOW TO STAND IN PRESERVCYT SOLUTION FOR 15 MINUTES**

After sample transfer to the PreservCyt Solution vial, the sample should stand for at least 15 minutes before processing to allow the PreservCyt Solution to render the sample non-infectious.

For more information on PreservCyt Solution, refer to Chapter 3, PreservCyt® and CytoLyt® Solutions.

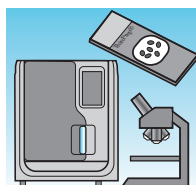
**SECTION
D-7****RUN ON THINPREP GENESIS PROCESSOR, FIX, STAIN, AND EVALUATE**

After the sample has been in contact with PreservCyt Solution for 15 minutes, it may be processed on the ThinPrep Genesis processor using the Slide or Slide + Aliquot process. The operator loads the processor, selects the appropriate item(s) to be processed, and selects the sample type as described in Chapter 7, Operating Instructions.

At the completion of the slide preparation process on the ThinPrep Genesis processor, the operator fixes and stains the slide according to the procedure in Chapter 10, Fixation, Staining, and Coverslipping.

When the slide is stained and coverslipped, it is microscopically reviewed by a cytotechnologist or pathologist. If the slide appears unsatisfactory after microscopic review, another slide may be made from the specimen using the procedures "Sample Preparation Troubleshooting" on page 5.24.

5

NON-GYNECOLOGIC SAMPLE PREPARATION

SECTION D-8

MECHANICAL AGITATION

Mucoid specimens require vigorous agitation in CytoLyt Solution to break up the mucus. Hologic recommends two methods of mechanical agitation:

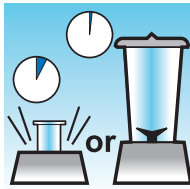

Method A:

Vortex the CytoLyt/Sample mixture for at least 5 minutes on a “hands-free” vortexor. The vortexor speed must be adjusted to produce visible agitation to the bottom of the tube.

Method B:

Blend the CytoLyt/Sample mixture for a few seconds.

Note: Agitation times for both methods may vary due to differences in specimen consistency.

The blending technique may show fragmentation or disruption of cell architecture. Excessive blending must be avoided.

Vortexing for at least 5 minutes after blending helps break up more mucus.

SECTION
D-9

CYTOLYT SOLUTION WASH

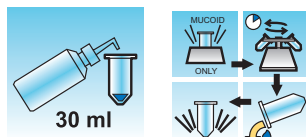

Addition of CytoLyt Solution to cell pellets is required to wash the sample. A **CytoLyt Solution wash** performs the following functions while preserving cellular morphology:

- Lyse red blood cells
- Dissolve mucus
- Reduce protein precipitation

A **CytoLyt Solution wash** consists of the following process:

- Adding 30 ml of CytoLyt Solution to a cell pellet
- *Muroid Specimens Only: Mechanical agitation*
- Concentration by centrifugation — 600 g x 10 minutes
- Pouring off the supernatant and vortexing to resuspend the cell pellet

One **CytoLyt Solution wash** is usually adequate to clean most non-gyn samples. For particularly bloody or muroid specimens, additional **CytoLyt Solution washes** may be necessary.

When a sample is collected in CytoLyt Solution at a ratio less than 30 parts CytoLyt Solution to 1 part sample, this is considered a *Collection Step* and not a *Wash Step*. For example, if one collects 15 ml of a sample and adds 30 ml of CytoLyt Solution to this sample, then the CytoLyt: sample ratio is only 2 to 1 and this is considered a sample collection step and still requires a **CytoLyt Solution wash**.

For more information on CytoLyt Solution, refer to Chapter 3, PreservCyt® and CytoLyt® Solutions.



NON-GYNECOLOGIC SAMPLE PREPARATION

SECTION E

SPECIMEN PREPARATION RECOMMENDATIONS





The following recommendations outline the preferred methods for preparing the different types of specimens. The methods are described in general terms.

For more detailed information about each step, refer to “Details of Non-Gynecologic Sample Preparation Steps” on page 5.4.

“Sample Preparation Troubleshooting” on page 5.24 provides troubleshooting for sample preparation.

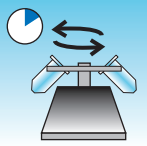
SECTION
E-1

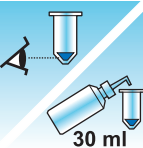
FINE NEEDLE ASPIRATES (FNA)

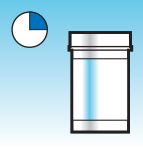
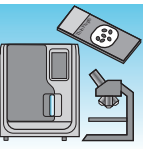
	<p>1. Collection: Collect sample directly into 30 ml of CytoLyt Solution. If specimen must be collected in an intravenous solution, use a balanced electrolyte solution.</p> <p>Note: If possible, flush the needle and syringe with a sterile anticoagulant solution prior to aspirating the sample. Some anticoagulants may interfere with other cell processing techniques, so use caution if you plan to use the specimen for other testing.</p>
	<p>2. Concentrate by centrifugation — 600 g for 10 minutes or 1200 g for 5 minutes.</p>
 <p>30 ml</p>	<p>3. Pour off supernatant and vortex to resuspend cell pellet.</p>
 <p>30 ml</p>	<p>4. Evaluate cell pellet appearance. Refer to page 5.11.</p> <p>If cell pellet is not free of blood, add 30 ml of CytoLyt Solution to cell pellet and repeat from step 2.</p>
	<p>5. Add appropriate amount of specimen (dependent on the size of the cell pellet) to PreservCyt Solution vial. Refer to page 5.12.</p>
	<p>6. Allow to stand in PreservCyt Solution for 15 minutes.</p>
	<p>7. Run on ThinPrep® Genesis processor using the Slide or Aliquot + Slide process for a Non-Gyn sample type. Fix, stain, and evaluate.</p>





5

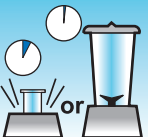
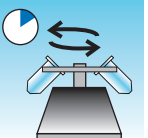

NON-GYNECOLOGIC SAMPLE PREPARATION

SECTION E-2

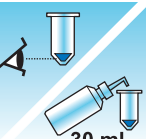
MUCOID SPECIMENS

Mucoid Specimens may include respiratory and gastrointestinal specimens.

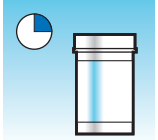
 <p>30 ml</p>	<p>1. Collection: Collect sample directly into 30 ml of CytoLyt Solution. OR Add 30 ml of CytoLyt Solution to the fresh specimen as soon as possible.</p> <p>Note: Large specimens (greater than 20 ml) should be concentrated before addition of CytoLyt Solution to the sample.</p>
<p>Optional:</p>	<p>If DTT is being used with respiratory mucoid samples, add stock before agitation. See the following page for preparation instructions.</p>
 <p>or</p>	<p>2. Mechanical agitation</p> <p>Note: Vortex for a minimum of 5 minutes in “hands-free” vortexor.</p>
	<p>3. Concentrate by centrifugation — 600 g for 10 minutes or 1200 g for 5 minutes.</p>
 <p>30 ml</p>	<p>4. Pour off supernatant and vortex to resuspend cell pellet.</p>
 <p>30 ml</p>	<p>5. Evaluate cell pellet appearance. Refer to page 5.11. Confirm the cell pellet is in liquid form. If the cell pellet is not in liquid form, add 30 ml of CytoLyt Solution and repeat steps 2-4.</p>
	<p>6. Add appropriate amount of specimen (dependent on the size of the cell pellet) to PreservCyt Solution vial. Refer to page 5.12.</p>

	7. Allow to stand in PreservCyt Solution for 15 minutes
	8. Run on ThinPrep® Genesis processor using the Slide or Aliquot + Slide process for a Non-Gyn sample type. Fix, stain, and evaluate.

Procedure for the Use of DiThioThreitol (DTT) with Muroid Non-Gyn Samples

DTT has been shown to be a reagent that is effective in reducing the amount of mucus in respiratory samples.^{1,2}

DTT stock solution

- Prepare a stock solution by adding 2.5 g DTT³ to 30 ml of CytoLyt Solution.
- This solution is suitable for use for 1 week when stored at room temperature (15°C–30°C).

Sample preparation

- This procedure is designed for muroid non-gyn samples to be processed onto a slide. Follow the steps for processing muroid specimens on the previous page. Removal of an aliquot after a sample has been prepared with DTT has not been validated on the ThinPrep Genesis processor.
- After sample collection (Step 1), but prior to vortexing (Step 2), add 1 ml of the stock DTT solution to the sample.
- Proceed with the remaining sample processing steps as listed.

1. Tockman, MS et al., 'Safe Separation of Sputum Cells from Muroid Glycoprotein' Acta Cytologica 39, 1128 (1995).

2. Tang, C-S, Tang CMC and Kung, TM, 'Dithiothreitol Homogenization of Prefixed Sputum for Lung Cancer Detection', Diagn. Cytopathol. 10, 76 (1994).

3. Available from Amresco, contact a sales representative at 800-448-4442 or www.amresco-inc.com.





5

NON-GYNECOLOGIC SAMPLE PREPARATION

SECTION E-3

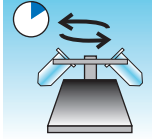
BODY FLUIDS

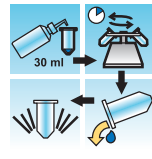
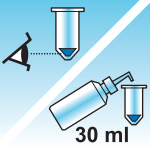
Body Fluids may include serous effusions, urinary and cerebrospinal fluids.

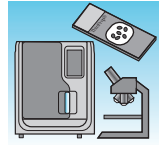

	<p>1. Collection: Collect body fluids fresh.</p> <p>Note: Fluids collected in CytoLyt Solution also require a CytoLyt Solution wash prior to instrument processing.</p> <p>Note: For extremely bloody fluids (e.g., pericardial), start with only 10 ml of fresh fluid.</p>
	<p>2. Concentrate by centrifugation — 600 g for 10 minutes or 1200 g for 5 Minutes.</p>
 <p>30 ml</p>	<p>3. Pour off supernatant and vortex to resuspend cell pellet.</p>
 <p>30 ml</p>	<p>4. CytoLyt Solution wash</p>
 <p>30 ml</p>	<p>5. Evaluate cell pellet appearance. Refer to page 5.11. If cell pellet is not free of blood, add 30 ml of CytoLyt solution to cell pellet and repeat from step 2.</p>
	<p>6. Add appropriate amount of specimen (dependent on the size of the cell pellet) to PreservCyt Solution vial. Refer to page 5.12.</p>
	<p>7. Allow to stand in PreservCyt Solution for 15 minutes</p>

	<p>8. Run on ThinPrep® Genesis processor using the Slide or Aliquot + Slide process for a Non-Gyn sample type. Fix, stain, and evaluate.</p>
---	--

**SECTION
E-4**

OTHER SAMPLE TYPES

Other sample types that are received in PreservCyt® Solution may include superficial brushings and scrapings, such as oral cavity specimens, nipple secretions, skin lesions (Tzanck Test), and eye brushings.

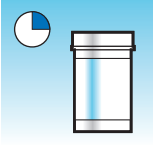
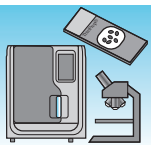
	<p>1. Collection: Deposit the specimen directly into a PreservCyt Solution vial.</p>
	<p>2. Gently shake the PreservCyt sample vial to mix the contents.</p>
	<p>3. Allow to stand in PreservCyt Solution for 15 minutes.</p>
	<p>4. Run on ThinPrep® Genesis processor using the Slide or Aliquot + Slide process for a Non-Gyn sample type. Fix, stain, and evaluate.</p>

5

NON-GYNECOLOGIC SAMPLE PREPARATION

SECTION F

URINE SPECIMENS FOR THE VYSIS™ UROVYSION ASSAY

For use with urine cytology processing or slide-based molecular testing, such as UroVysion assay urine specimens.

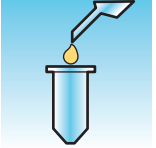
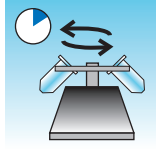
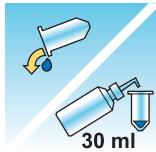
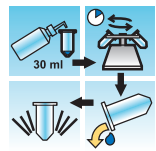
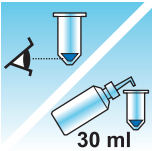
	<p>1. Collection. Collect urine , OR process urine fresh.</p> <p>Note: Fresh urine can be mixed with a 2:1 urine-to-PreservCyt® Solution ratio and stored for up to 48 hours before processing.</p> <p>Note: Do not exceed a 2:1 ratio of urine to PreservCyt Solution. If the urine volume exceeds 60 ml, pour off excess. A minimum volume of 33 ml of urine is required to perform the UroVysion assay.</p>
	<p>2. Concentrate by centrifugation.</p> <p>Transfer the sample evenly into two labeled to 50 ml centrifuge tubes. Centrifuge at 600 g for 10 minutes or 1200 g for 5 minutes.</p>
	<p>3. Pour off supernatant and resuspend cell pellet.</p> <p>Resuspension can be done on a vortexor or may be achieved by syringing the pellet back and forth with a plastic pipette.</p>
	<p>4. CytoLyt® Solution wash</p> <p>Add 30 ml of CytoLyt Solution to one 50 ml centrifuge tube and vortex. Transfer the contents of this tube into the second 50 ml centrifuge tube and vortex. The specimen is now combined into one 50 ml tube. The empty tube can be discarded.</p> <p>Centrifuge.</p> <p>Pour off supernatant.</p> <p>Resuspend cell pellet.</p>
	<p>5. Evaluate cell pellet appearance.</p> <p>Refer to page 5.11.</p> <p>If the cell pellet is not free of blood, add 30 ml of CytoLyt Solution and repeat from step 4.</p>

	<p>6. Add entire specimen to PreservCyt® Solution vial. Allow to stand in PreservCyt Solution for 15 minutes.</p>
	<p>7. Run on ThinPrep® Genesis processor using the Slide or Aliquot + Slide process for a UroCyte sample type. Fix, stain, and evaluate cytology, OR perform the molecular diagnostic testing according to the manufacturer's instructions for use.</p> <p>Note: UroCyte samples require the yellow ThinPrep UroCyte filter and UroCyte microscope slide for processing.</p>

Urine Specimen Collection

	<p>1. On the specimen collection cup, record patient information in the space provided.</p>
	<p>2. Collect urine in a routine manner. If urine volume exceeds 60 ml, pour off excess. The total volume of urine must not exceed 60 ml. A minimum of 33 ml of urine is required to perform the Vysis® UroVysion assay.</p>



NON-GYNECOLOGIC SAMPLE PREPARATION

SECTION G

SAMPLE PREPARATION TROUBLESHOOTING

Because there is biological variability among samples and variability in collection methods, standard processing may not always yield a satisfactory and uniformly distributed preparation on the first slide. This section contains instructions for further sample processing to obtain better quality subsequent slides in these cases.



After staining, you may observe the following irregularities:

- Non-uniform distribution of the cells in the cell spot that was not accompanied by a “Sample Is Dilute” message,
- Uneven distribution in the form of a ring or “halo” of cellular material and/or white blood cells,
- A sparse cell spot lacking in a cellular component and containing blood, protein, and debris. This type of slide may be accompanied by a “Sample Is Dilute” message.

Note: Satisfactory slide appearance is a matter of judgment and experience. Hologic recommends that you check the quality of the slide after staining. If you determine that the slide is unsatisfactory, use the procedures in this section to make additional slides.





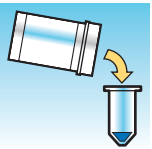
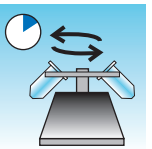
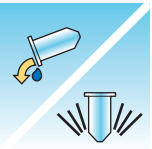
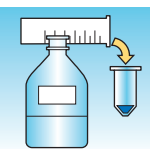

Caution: Be sure to use a new non-gynecologic filter for each slide.

Bloody or Proteinaceous Specimens

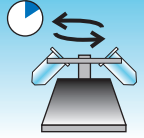

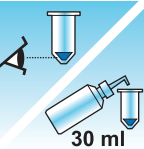
Problem	Procedure	
<p>A. Did the “Sample Is Dilute” message appear during processing? NO ↓ YES ⇒</p>	<p>1. Check to see if cellularity is adequate. If not, use more of the pellet if available. Prepare a slide using the Slide or Aliquot + Slide process for a Non-Gyn sample type.</p> 	
<p>B. Does the slide have an obvious “halo” of cellular material and/or white blood cells? NO ↓ YES ⇒</p>	<p>1. Dilute the sample 20:1. Use a calibrated pipette to add 1 ml of sample to a new PreservCyt Solution vial. Prepare slide using the Slide or Aliquot + Slide process for a Non-Gyn sample type. If a halo is present on the new slide, call Hologic Technical Support.</p> 	
<p>C. Is the slide sparse and does it contain blood, protein, or non-cellular debris? NO ↓ YES ⇒</p>	<p>1. Pour the contents of the PreservCyt Sample vial into a centrifuge tube.</p> 	
<p>Call Hologic Technical Support.</p>	<p>2. Concentrate by centrifugation — 600 g for 10 min. or 1200 g for 5 min.</p> 	
	<p>3. Pour off supernatant and vortex to resuspend cell pellet.</p> 	
	<p>4. If the sample contains blood or non-cellular debris: Mix a solution of 9 parts CytoLyt Solution to 1 part glacial acetic acid. Add 30 ml of this solution to the sample centrifuge tube. If the sample contains protein: Add 30 ml of saline to the sample centrifuge tube.</p> 	

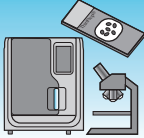
5

NON-GYNECOLOGIC SAMPLE PREPARATION

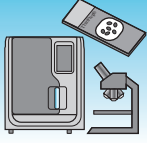
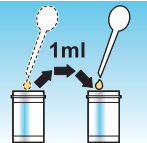
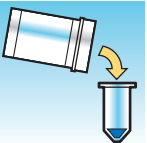
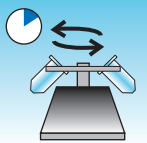
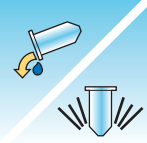

Problem	Procedure	
	5. Concentrate by centrifugation — 600 g for 10 min. or 1200 g for 5 min.	
	6. Pour off supernatant and vortex to resuspend cell pellet.	
	7. Evaluate cell pellet appearance. Refer to page 5.11. If pellet contains blood or protein, repeat from step 4.	
	8. Add appropriate amount of specimen to PreservCyt Solution vial. Refer to page 5.12.	
	9. Run on ThinPrep® Genesis processor using the Slide or Aliquot + Slide process. Fix, stain, and evaluate.	
	10. If the new slide is sparse, call Hologic Technical Support.	

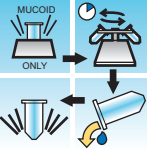
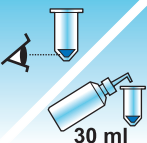
Mucoid Specimens

Problem	Procedure	
<p>A. Did the “Sample Is Dilute” message appear during processing? NO ↓ YES ⇒</p>	<p>1. Check to see if cellularity is adequate. If not, use more of the pellet if available. Prepare a slide using the Slide or Aliquot + Slide process for a Non-Gyn sample type.</p> 	
<p>B. Does the slide have an obvious “halo” of cellular material and/or white blood cells? NO ↓ YES ⇒</p>	<p>1. Dilute the sample 20:1. Use a calibrated pipette to add 1 ml of sample to a new PreservCyt Solution vial. Prepare slide using the Slide or Aliquot + Slide process for a Non-Gyn sample type. If a halo is present on the new slide, call Hologic Technical Support.</p> 	
<p>C. Is the slide sparse and does it contain mucus? NO ↓ YES ⇒</p>	<p>1. Pour the contents of the PreservCyt sample vial into a centrifuge tube.</p> 	
<p>Call Hologic Technical Support.</p>	<p>2. Concentrate by centrifugation. 600 g for 10 min. or 1200 g for 5 min.</p> 	
	<p>3. Pour off supernatant and vortex to resuspend cell pellet.</p> 	
	<p>4. CytoLyt Solution wash</p>  	
	<p>5. Evaluate cell pellet appearance. Refer to page 5.11. If pellet contains mucus, repeat from step 4.</p> 	

5

NON-GYNECOLOGIC SAMPLE PREPARATION

Problem	Procedure	
	6. Add appropriate amount of specimen to PreservCyt Solution vial. Refer to page 5.12.	
	7. Run on ThinPrep® Genesis processor using the Slide or Aliquot + Slide process. Fix, stain, and evaluate.	
	8. If the new slide is sparse, call Hologic Technical Support.	

Common Artifacts

Smudged Nuclear Detail

The chromatin detail of nuclei can appear smudged if saline, PBS, or RPMI are used as the collection fluids. To avoid this problem, collect the sample either fresh, in CytoLyt Solution, or in a balanced electrolyte solution. Refer to “Fine Needle Aspirates (FNA)” on page 5.17 for more detail on collection fluids.

Halo Artifact

In some cases of dense specimens, only the outer edge of cellular material may transfer to the ThinPrep slide forming a “halo” or ring of cellular material on the slide. If the slide is not satisfactory, a second slide may be produced following the sample preparation troubleshooting procedures on the previous page.

Compression Artifact

Some samples may display what appears to be “air-dry” artifact on the perimeter of the cell spot. This artifact is not air-drying but rather it is due to the compression of cells between the edge of the filter and the glass slide.

Staining Artifact

Some samples may display a staining artifact which mimics air-drying in appearance. This artifact appears as a red or orange central staining primarily in cell clusters or groups. This artifact is due to incomplete rinsing of the counterstains. Fresh alcohol baths or an additional rinse step after the cytoplasmic stains is required to eliminate this artifact.

Edge of the Cylinder Artifact

Some samples may display a narrow rim of cellular material just beyond the circumference of the cell spot. This artifact is a result of cells from the outer edge of the wet filter cylinder being transferred to the glass slide. This may be more evident on highly cellular samples because there will be more cells to be transferred in the liquid.



NON-GYNECOLOGIC SAMPLE PREPARATION

Techniques Used in Troubleshooting

Diluting the Sample 20 to 1

To dilute a sample suspended in PreservCyt Solution, add 1 ml of the sample that is suspended in PreservCyt Solution to a new PreservCyt Solution vial (20 ml). This is most accurately done with a calibrated pipette.

You may also simply count drops from an uncalibrated plastic pipette if you know how many drops correspond to 1 ml. To calculate this, count out drops of PreservCyt Solution into a container of known volume. When the known volume is reached, divide the number of drops by the volume (in ml) to get the number of drops that corresponds to 1 ml. Use PreservCyt Solution rather than any other liquid so the drop size will be consistent with the sample drops.

Glacial Acetic Acid Wash for Blood and Non-Cellular Debris

If a sample is found to be bloody during microscopic review, it can be further washed using a solution of 9 parts CytoLyt Solution and 1 part Glacial acetic acid. This should only be done after the sample has been in PreservCyt Solution. Do not use directly with fresh specimens; nuclear morphology may not be adequately preserved.

Saline Wash for Protein

If a sample is found to contain protein during microscopic review, it can be further washed using saline solution in place of CytoLyt Solution. This should only be done after the sample has been in PreservCyt Solution. Do not use directly with fresh specimens; nuclear morphology may not be adequately preserved.

Chapter Six

User Interface

This chapter provides detailed information on the user interface screens and how to use them to operate, troubleshoot and maintain the ThinPrep® Genesis processor.

The content found in this chapter:

Screen Display	6.2
• Scan or Enter Information	6.2
Main Menu, Processor Idle.....	6.3
• Log In (optional)	6.4
• Items to Process.....	6.6
• Sample Type Buttons	6.7
• System Overview and Status Indicators	6.7
• Begin Loading Button.....	6.8
Administrative Options	6.9
• System Settings	6.10
• System Maintenance.....	6.23
• Slide Printer	6.25
• Tube Printer	6.26
• Slide Labels	6.26
• Tube Labels	6.36
• Configure Barcodes.....	6.38
• About	6.55
• Reports	6.56



USER INTERFACE

SECTION A

SCREEN DISPLAY

On the ThinPrep Genesis processor, the screen displays are designed to guide the operator through a sequence of steps.

The **Back** button typically steps the back one step in the sequence.

The **Cancel** button cancels the current step and returns to the start of the sequence.

Scan or Enter Information

If the chain of custody feature is enabled on the ThinPrep Genesis processor, there are some steps where the operator needs to scan or enter information. For these steps, the processor repositions the scanner and the red light on the scanner blinks.

Scan data

To scan the information, such as a vial ID, open the door and hold the item to be scanned so that the barcode on the item is parallel to the scanner. Hold the item to be scanned so that the scanner's green light is in the center of the barcode. See Figure 7-14.

The processor will beep after a successful scan. If the processor successfully scans a barcode, but the information does not match the configuration set on the processor, the processor will make a different sound, the red scanner light blinks, and an orange message displays on the screen.

Note: If the Sound setting for the processor has the tones turned off, there are no audible sounds.

Enter data with the keypad

To enter data manually, tap the field. A keypad with numbers and letters displays.

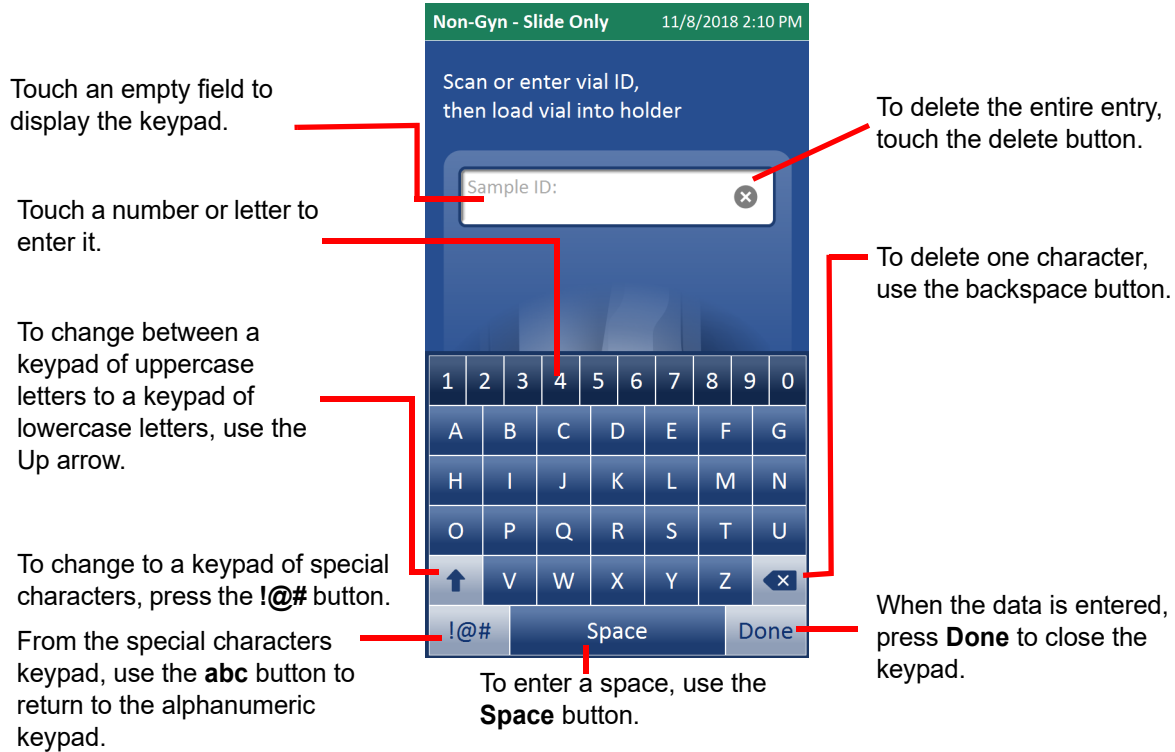

Figure 6-1 Keypad

SECTION B

MAIN MENU, PROCESSOR IDLE

When the ThinPrep® Genesis processor is powered on and ready for use, the main screen will be displayed.

6

USER INTERFACE

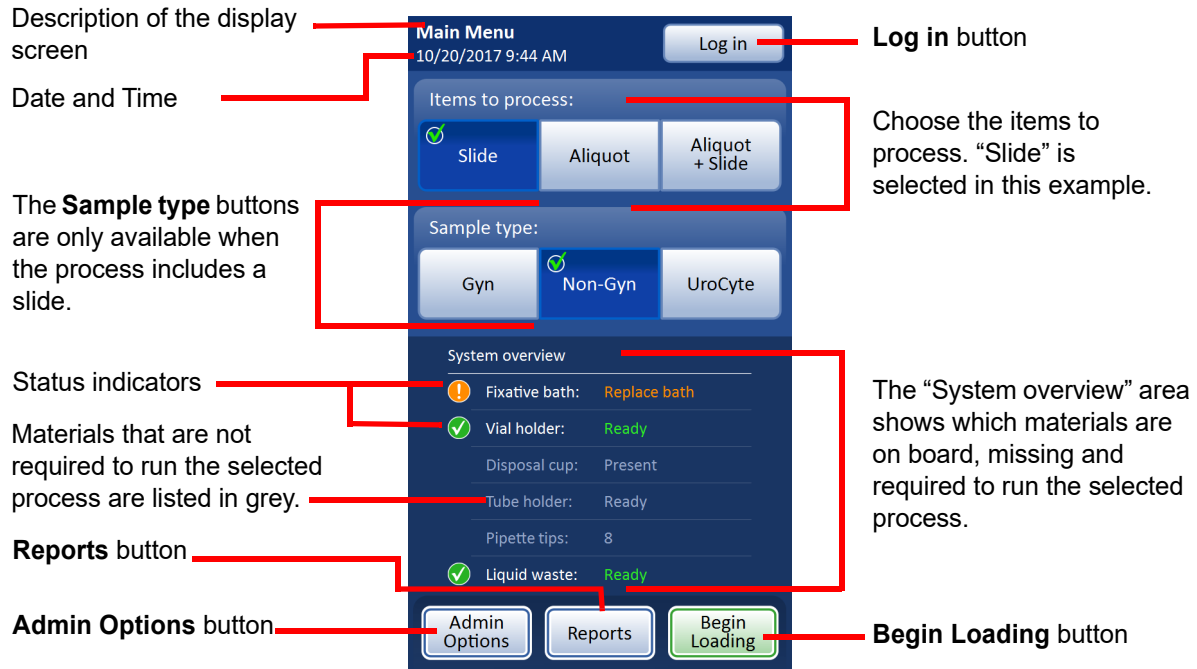

Figure 6-2 Main menu

Log In (optional)

An operator can log in on the ThinPrep Genesis processor. If an operator logs in, the User ID information is recorded in the reports generated by the ThinPrep Genesis processor.



Figure 6-3 Log in button

1. Press the **Log in** button. A user log in screen appears.

Use the barcode scanner in the ThinPrep Genesis processor or touch the User ID field on the screen and use the keyboard to enter your ID.

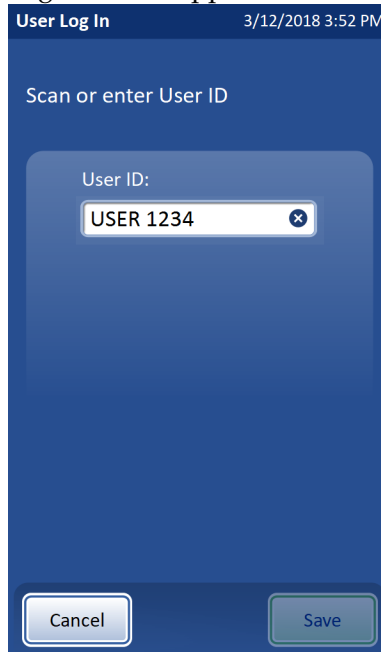

The maximum length for the User ID is 64 characters.

Figure 6-4 User log in

2. Enter the User ID and press **Save**.
On the Main menu, the **Log in** button changes to a **Log out** button and shows the user ID.

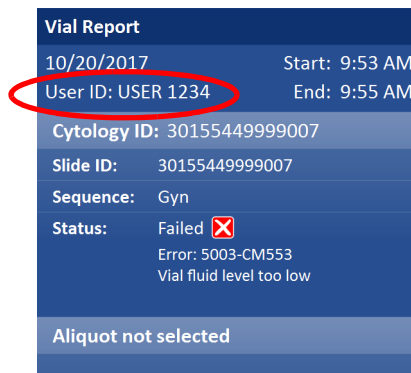
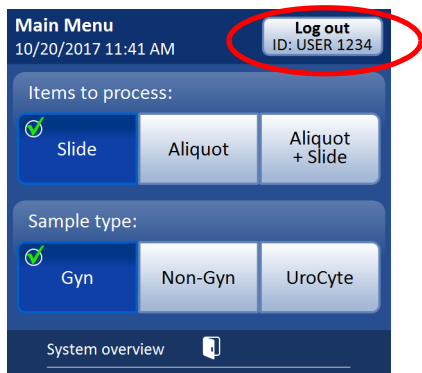

The user ID will be recorded in the vial report for vials processed while that user is logged in.

Figure 6-5 User ID on main menu and vial report

The ThinPrep Genesis processor can be run without logging in. If the operator has not logged in, the reports will not include any User ID information.

Log out

To log out of the processor, from the Main menu, press the **Log out** button.

6

USER INTERFACE

A confirmation screen displays. Press the **Log out** button on the confirmation screen to log out, or press **No** to remain logged in.

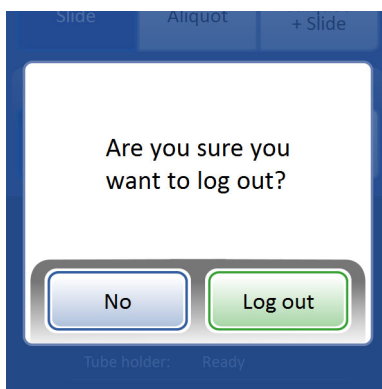
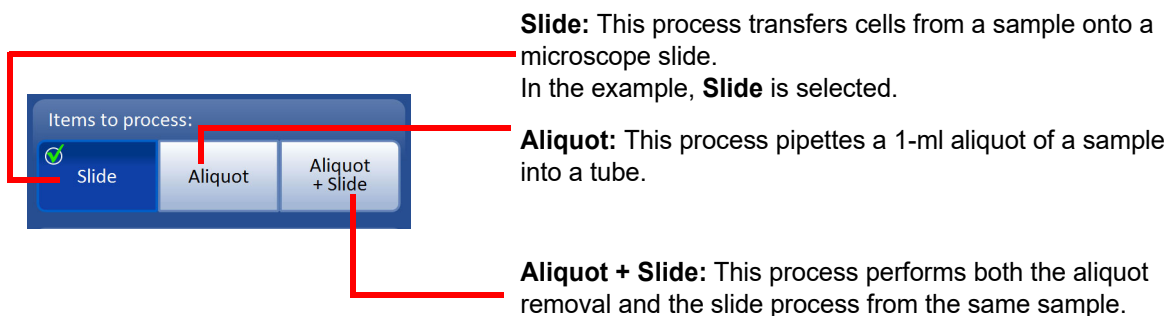

Figure 6-6 Confirm log out

Items to Process

Prior to loading the processor, select the item(s) that will be processed from the sample vial: Slide, Aliquot, or Aliquot + Slide.



Slide: This process transfers cells from a sample onto a microscope slide.
In the example, **Slide** is selected.

Aliquot: This process pipettes a 1-ml aliquot of a sample into a tube.

Aliquot + Slide: This process performs both the aliquot removal and the slide process from the same sample.

Figure 6-7 Items to process

CAUTION: The items to process selection does not need to be selected each time the processor is loaded. The selection persists until the operator changes it. However, if the instrument is shut down and restarted, or if the language setting is changed, the selection defaults to Slide and would need to be changed to run the Aliquot or Aliquot + Slide process.

Sample Type Buttons

Prior to loading the processor, if the process is Slide or Aliquot + Slide, select the sample type that will be run: gynecologic samples, non-gynecologic samples, UroCyte® samples.

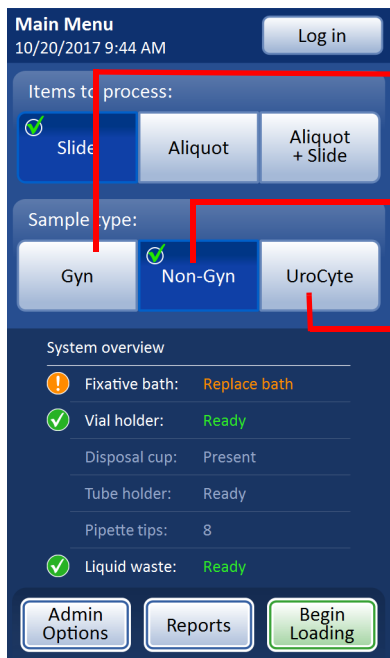

For running a gynecologic specimen.

Use clear ThinPrep® Pap test filters and ThinPrep Pap Test microscope slides or ThinPrep Pap Test microscope slides for use with the ThinPrep Imaging System.

For running a non-gynecologic specimen.

Use blue ThinPrep non-gynecologic filters and ThinPrep microscope slides.

For running a urine specimens for use in conjunction with the UroVysion™ assay.

Use yellow ThinPrep UroCyte filters and ThinPrep UroCyte microscope slides.

Figure 6-8 Sample type buttons

CAUTION: The sample type does not need to be selected each time the processor is loaded. The selection persists until the operator changes it. However, if the instrument is shut down and re-started, or if the language setting is changed, the sample type selection defaults to Gyn and would need to be selected to run Non-Gyn or UroCyte sample types.

System Overview and Status Indicators

The status indicators are located in the System overview area of the main menu.

✓ The green circle with check mark indicates that the system component is ready and required for the process that the operator selected.

! The orange circle with exclamation point indicates that system component or supply is required and is not ready. In this example, the fixative bath needs to be replaced.

For items that are not required for the process that the operator selected, each item, along with its status, is listed in grey, without the circle icons.

Fixative bath - The ThinPrep Genesis processor monitors whether the fixative bath is present or not. If the fixative bath is required and present, the icon is a check mark and the word, "Ready" displays in green. If the fixative bath is required but is not present, the icon is the exclamation point and the words, "Replace bath" display in orange. The fixative bath is not required for the Aliquot process; if



USER INTERFACE

there is a fixative bath in the fixative bath holder when the Aliquot process is selected, the grey status message is “Present”.

Vial holder - The ThinPrep Genesis processor monitors whether a sample vial is in the vial holder or not. If the vial holder is empty, the icon is a check mark and the word “Ready” displays in green. If there is a sample vial in the vial holder too early in the loading process, then the icon is the exclamation point and the words, “Remove vial to start” display in orange.

Disposal cup - The ThinPrep Genesis processor monitors whether the disposal cup for pipette tips is present or not. If the disposal cup is required and present, the icon is a check mark and the word, “Present” displays in green. If the disposal cup is required but is not present, the icon is the exclamation point and the words, “Replace pipette tip waste” display in orange. The disposal cup is not required for the Slide process; if the disposal cup is present when the Slide process is selected, the grey status message is “Present”.

Tube holder - The ThinPrep Genesis processor monitors whether a tube is in the tube holder or not. If a tube is required and the tube holder is empty, the icon is a check mark and the word, “Ready” displays in green. If the tube will be required but is in the tube holder too early in the loading process, then the icon is the exclamation point and the words, “Remove tube to start” display in orange. A tube is not required for the Slide process; if there is a tube in the tube holder when the Slide process is selected, the grey status message is “Tube present”.

Pipette tips - The ThinPrep Genesis processor monitors the number of pipette tips that are ready to use, loaded in the pipette tip holder. If a pipette tip is required and there is at least one pipette tip present, the icon is a check mark and the number of pipette tips displays in green. If the pipette tip holder is empty, the count is “0”. A pipette tip is not required for the Slide process; when the Slide process is selected, the number of pipette tips displays in grey.

Liquid waste - The system monitors if the liquid waste bottle is present and if needs to be emptied. If the liquid waste bottle is ready, the icon is a check mark and the word, “Ready” displays in green. If the waste bottle needs to be emptied or if the waste bottle is not present, the icon is the exclamation point and the words, “Empty liquid waste” display in orange. If the waste bottle failed the waste bottle leak test, the icon is the exclamation point and the words, “Leak test failed” display in orange. The **Begin Loading** button is only available when the waste bottle is ready.

Begin Loading Button

To begin loading the processor, press the **Begin loading** button.



Figure 6-9 Begin Loading button

Refer to Chapter 7, “Operating Instructions” for instructions on loading the ThinPrep Genesis processor.

SECTION
C

ADMINISTRATIVE OPTIONS

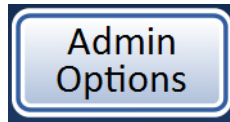

Figure 6-10 Admin Options button

The Admin Options (Administrative Options) screen allows user interface with the processor outside of processing samples. From the main menu, press the **Admin Options** button to access the Administrative Options screen.

The screenshot shows the 'Admin Options' screen with the following callouts:

- System Settings:** Use the **System Settings** button to apply or change system settings.
- System Maintenance:** Use the **System Maintenance** button to for the instrument-assisted maintenance activities.
- Slide Printer:** Use the **Slide Printer** button to turn the connection to the optional slide printer on or off. In this example, the green circle indicates the "On" setting.
- Tube Printer:** Use the **Tube Printer** button to turn the connection to the optional tube printer on or off. In this example, the grey circle indicates the "Off" setting.
- Slide Labels:** Use the **Slide Labels** button to create or change the design of slide labels.
- Tube Labels:** Use the **Tube Labels** button to create or change the design of tube labels.
- Configure Barcodes:** Use the **Configure Barcodes** button to enter information about the kinds of IDs used on vials, slides and tubes.
- About:** Press the **About** button for information about the processor.
- Back:** Use the **Back** button to return to the main menu.
- Shutdown:** Use the **Shutdown** button to turn off the ThinPrep Genesis processor.

Figure 6-11 Administrative Options screen

Each of the Admin options is described below.

6

USER INTERFACE

System Settings

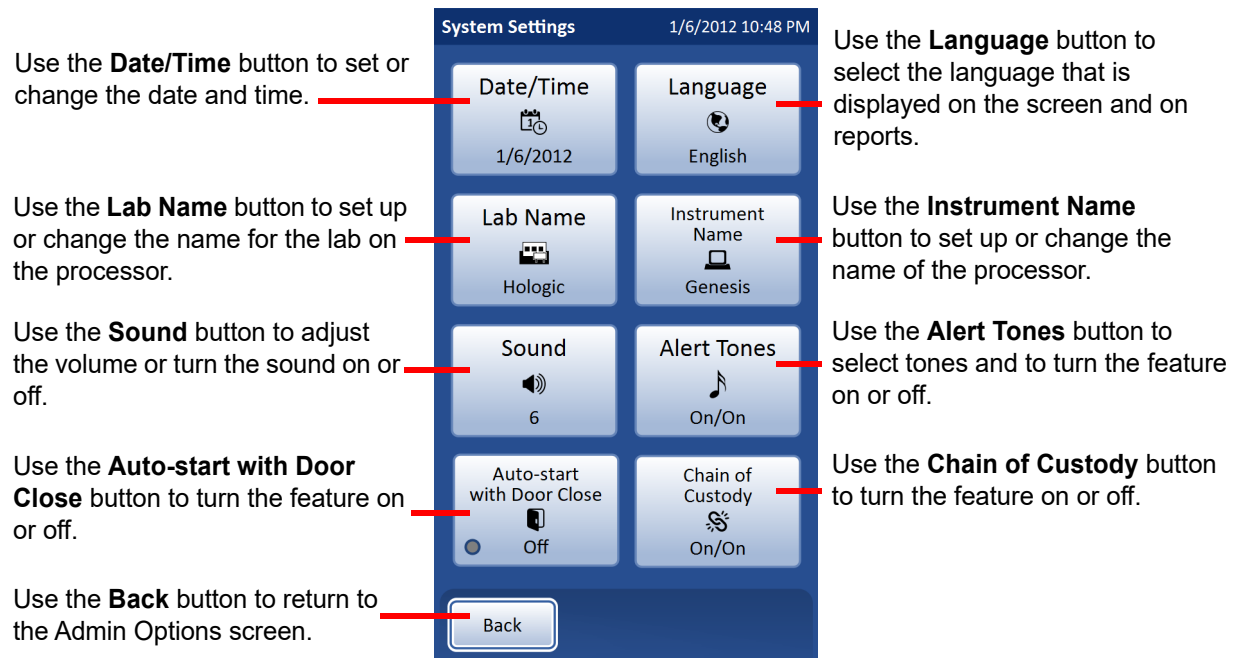
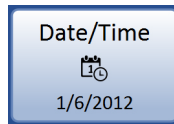

Figure 6-12 System Settings screen

From this menu, the operator may apply or change system settings.

Date/time



Date/Time button shows current setting.

Figure 6-13 Date/Time button

Press the **Date/Time** button to set or change the date and time that are displayed on the user interface, in label design, and used on the reports.

To change the date (day, month or year) touch the up-triangle or the down-triangle for that field until the desired value is displayed.

Press **Cancel** to cancel changes, revert to the previous setting and return to the System Settings screen.

Select the meridian, if displayed. (These buttons are not displayed if the time is displayed in the 24-hour time format.)

Press the **Save** button to save and return to the System Settings screen.

Note: Depending on which language has been selected, the format for the date and time shown on the display may change to reflect customary usage.

Figure 6-14 Date/Time screen

6

USER INTERFACE

Language



Language button shows the current setting.

Figure 6-15 Language button

Press the **Language** button to select the language that is displayed on the user interface and on the reports.

The screenshot shows a "Language" settings screen. It has two main sections: "Select a language:" and "Select a country:". The "Select a language:" section has a list with "English" selected, indicated by a green checkmark. The "Select a country:" section has a list with "United States" selected, also indicated by a green checkmark. At the bottom are "Cancel" and "Save" buttons. Red lines with text boxes point to various elements: "English" in the language list, "United States" in the country list, the "Cancel" button, and the "Save" button. There are also annotations for the up and down arrow buttons next to the lists.

Press the name of a language to select it from the list of available languages.

Press the name of a country to select it. This will apply customary time and date format for the language and country selected.

Press **Cancel** to return to the System Settings screen without making any changes.

Press the up-triangle or the down-triangle to scroll through the list.

Press **Save** to immediately apply the selected language and country and return to the System Settings screen.

Figure 6-16 Select language screen

Lab name

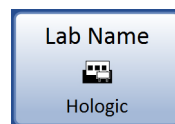

Lab Name button shows current setting.

Figure 6-17 Lab Name button

To enter or edit a name for the facility at which the processor is located, press the **Lab Name** button. The Lab name set here can be used in the label design features of the processor. Press the keypad buttons to enter a name, up to 64 characters in length. Switch between the uppercase, lowercase, and special characters as often as desired before saving changes. See Figure 6-18.



Figure 6-18 Enter or edit Lab Name via the keypad

Instrument name

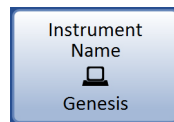

Instrument Name button shows current setting.

Figure 6-19 Instrument Name button

To enter or edit a name for the ThinPrep Genesis processor, press the **Instrument Name** button. The Instrument name set here can be used in the label design features of the processor. Press the keypad buttons to enter a name, up to 64 characters in length. Switch between the uppercase, lowercase, and special characters as often as desired before saving changes. See Figure 6-20.

6

USER INTERFACE

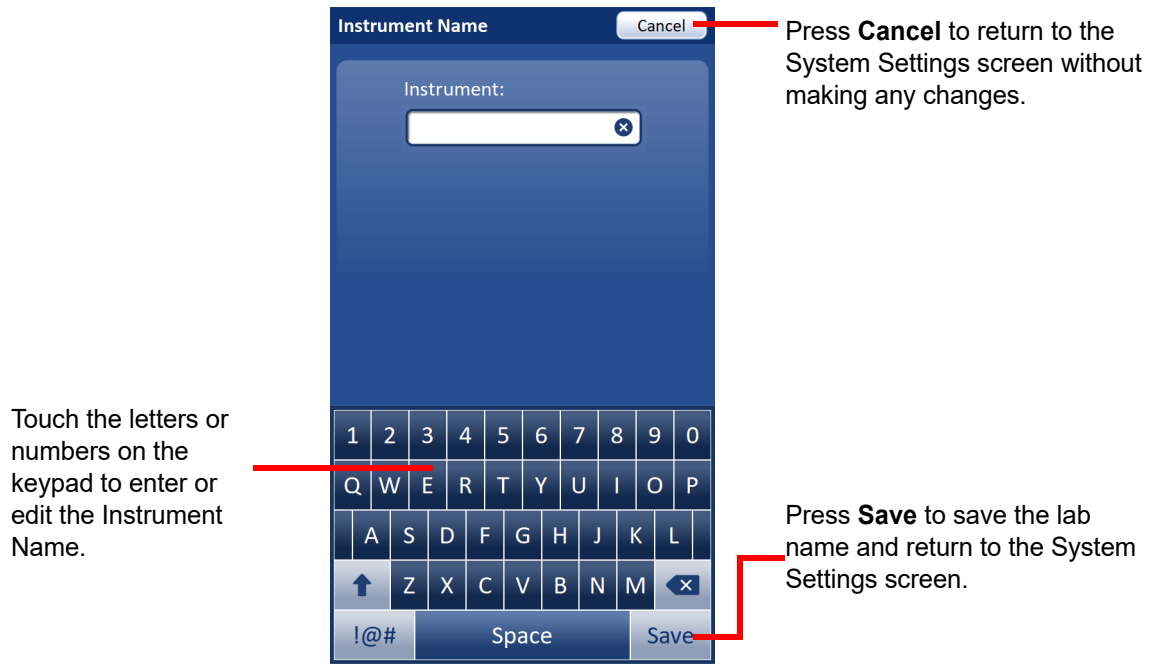
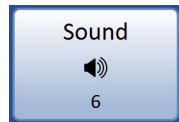

Figure 6-20 Enter or edit the Instrument Name via the keypad

Sound



Sound volume button shows current setting.

Figure 6-21 Sound button

Audible alert tones can be set to sound when a process completes and during an error condition. The volume of the audible alert tones may be increased or decreased. Use the Sound setting to turn audible alerts on or off and to adjust the volume of the audible alert.

System sounds
Press the **On** button to have the audio setting on.
Press the **Off** button to have the audio turned off.
The selection is marked with a check mark.

Audio volume
Press the increase (+) or decrease (-) button to change the sound level and hear the sound at the new volume.

Press **Cancel** to return to the System Settings screen without making any changes.

Press **Save** to save the setting adjustment and return to the System Settings screen.

Figure 6-22 Sound screen

Press the - (**decrease**) button one or more times to decrease the volume. Press the + (**increase**) button one or more times to increase the volume (0 to 10). The sound plays at the new volume when the + or - button is pressed. Continue to adjust and preview the sound volume until it is satisfactory. Press the **Save** button to save the setting and return to the System Settings screen.

Alert tones



Alert Tones button shows the current setting.

Figure 6-23 Alert Tones button

Alert tones are audible alarms that sound when a process completes or during an error condition. Three sounds are offered for each. Select a tone or select the option to turn on or turn off any audible alarm for each condition.

Note: To hear the alert tone, the sound must be on. The volume of the tones is adjusted by the Sound screen. See “Sound” on page 6.15.

Having differentiated tones makes it easier to know if the processor has completed a process or needs attention. In a setting that might have multiple machines, the different tones can help identify them.

Press the **On** button to have the processing complete alert turned on.
 Press the **Off** button to have the processing complete alert turned off.
 The selection is marked with a check mark.

Turn the option on, and then select a tone.

Press the **On** button to have the error alert turned on.
 Press the **Off** button to have the error alert turned off.
 The selection is marked with a check mark.

Press the sound icon to hear the tone.

Press **Cancel** to return to the System Settings screen without making any changes.

Press **Save** to save the setting adjustment and return to the System Settings screen.

Figure 6-24 Alert Tones screen for batch completion and error condition

When a process completes, the processing complete alert tone will sound once.

When an error condition occurs, the error alert tone will sound and then repeat every few seconds. The error message window will have a **Silence Alarm** button that can be pressed to turn the alarm off. See Figure 6-25.

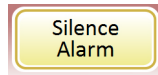
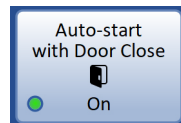

Figure 6-25 Silence Alarm button

Auto-start with door close



Auto-start with Door Close button shows the current setting.

Figure 6-26 Auto-start with Door Close button

Press the **Auto-start with Door Close** button to toggle between on and off.

The door must be closed before starting any process on the ThinPrep Genesis Processor.

When the Auto-start with Door Close setting is on, the process begins as soon as the operator closes the door.

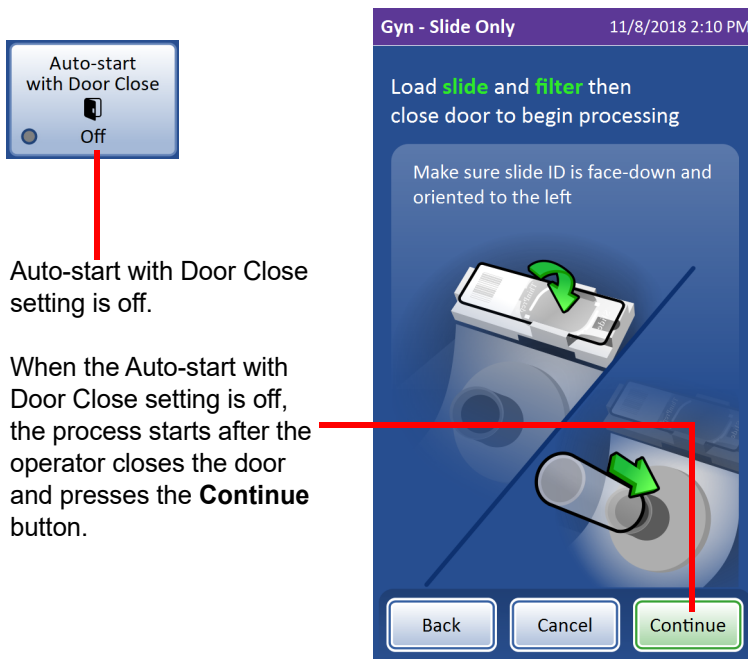

Auto-start with Door Close setting is off.

When the Auto-start with Door Close setting is off, the process starts after the operator closes the door and presses the **Continue** button.

Figure 6-27 Auto-start with door close off

6

USER INTERFACE

Chain of custody

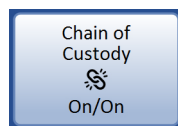

Chain of Custody button shows the current setting.

Figure 6-28 Chain of Custody button

The ThinPrep Genesis Processor can be set up to compare the ID information on the sample vial with information on the slide, the tube or both. The **Chain of Custody** button enables or disables that comparison. For more information about label formats, refer to “Configure Barcodes” on page 6.38.

Or, with the chain of custody turned off, the ThinPrep Genesis Processor can be set up to not use the vial ID, the slide ID, or the tube ID at all.

Press the **Chain of Custody** button to access the settings for this chain of custody feature.

Press **On** in the “Cytology-Vial and Slide” area to:

- have the processor check that the cytology ID is in the format set up for the ID,
- make the processor compare the cytology ID on the sample vial with the slide ID, and
- include the cytology ID and the slide ID on vial reports.

With the chain of custody for the vial and slide turned on, the processor requires the operator to scan or enter the cytology ID on the vial during the loading process, and the processor will scan the slide label before it transfers sample to the slide.

Press **On** in the “Molecular - Vial and Tube” area to:

- have the processor check that the molecular ID is in the format set up for the ID,
- make the processor compare the molecular ID on the sample vial with the tube ID, and
- include the molecular ID and the tube ID on vial reports.

With the chain of custody for the vial and tube turned on, the processor requires the operator to scan or enter both the molecular ID on the vial and the ID on the tube during the loading process.

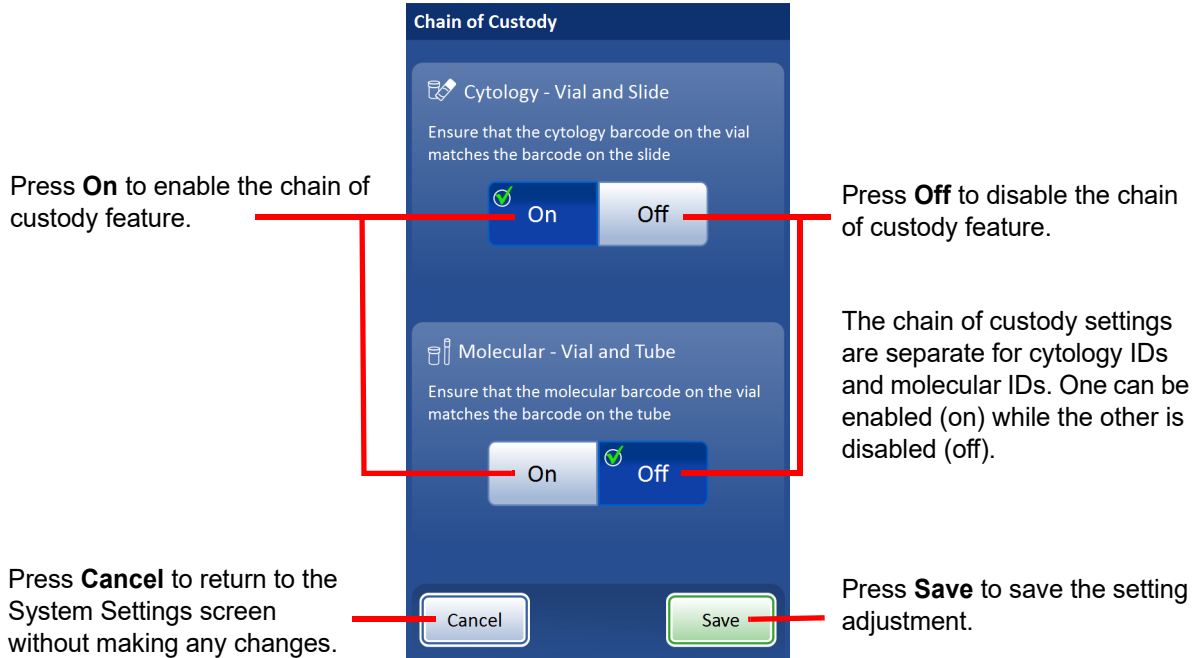

Figure 6-29 Chain of Custody screen

To disable the chain of custody, select **Off** and press **Save**. A confirmation screen appears.

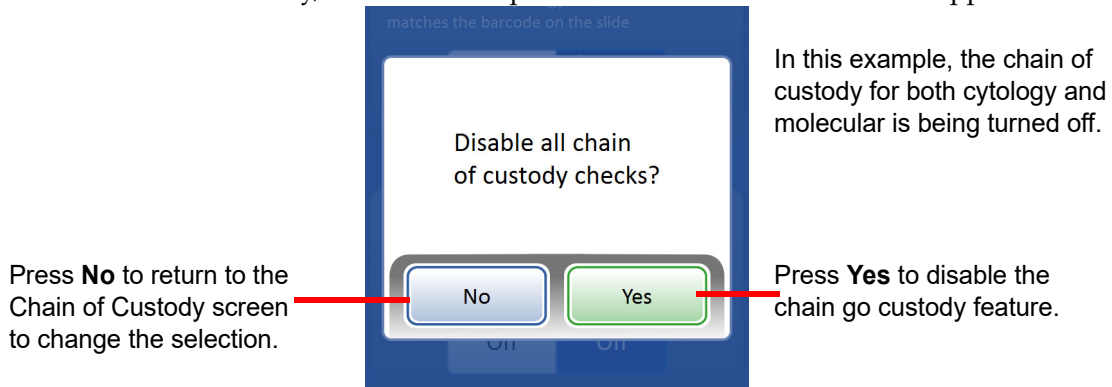

Figure 6-30 Confirm disabling chain of custody

6

USER INTERFACE

When the chain of custody is enabled in the Admin Options of the processor, the first steps in the Begin Loading sequence are to enter the ID information from the vial.

The cytology ID or sample ID on the vial must be entered during the loading steps if cytology chain of custody is on.

The molecular ID or sample ID on the vial must be entered during the loading steps if molecular chain of custody is on.

If the ID on the vial matches the set-up on the processor, a green check mark appears.

If an ID on the vial does not match the set-up on the processor, the loading process stops before the vial is loaded. Press **Back** to re-enter the ID.

Figure 6-31 Chain of custody on - begin loading by entering ID(s) from vial

When the chain of custody is enabled for molecular IDs in the Admin Options of the processor, after the vial ID information is entered, the next step in the Begin Loading sequence is to enter the tube ID. This step only happens when an aliquot is among the items to process.

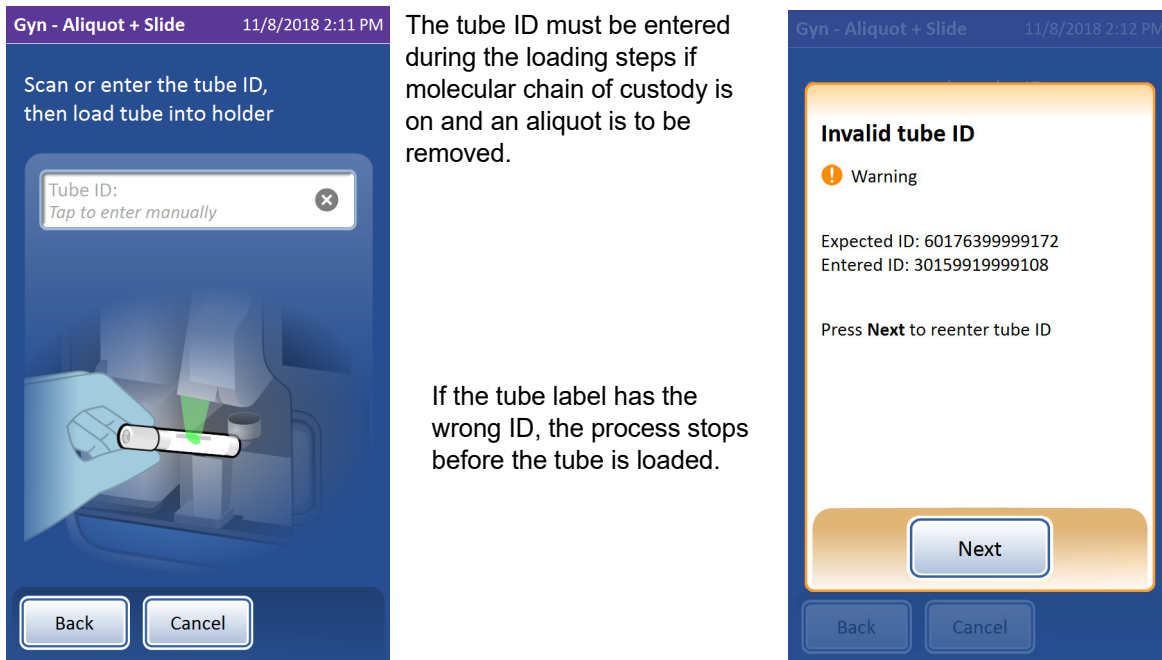

The tube ID must be entered during the loading steps if molecular chain of custody is on and an aliquot is to be removed.

If the tube label has the wrong ID, the process stops before the tube is loaded.

Figure 6-32 Chain of custody on - enter tube ID

6

USER INTERFACE

When chain of custody is enabled in the Admin Options of the processor, when a slide is among the items to be processed, the processor scans the slide label during processing to check that it matches the slide label format set for the processor.

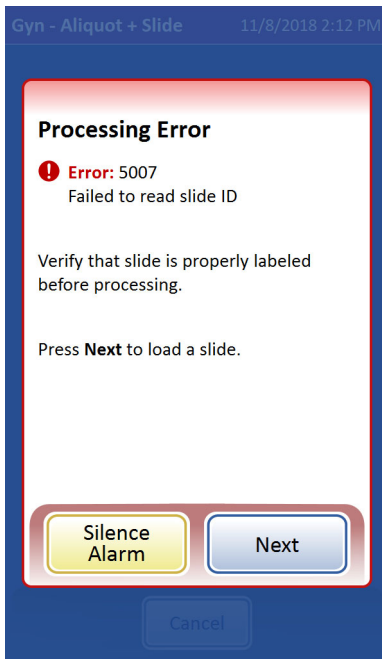

If the slide label has the wrong ID, the process stops before the vial is uncapped.

Press **Next** to dismiss the error screen and remove the slide with the wrong ID.

Figure 6-33 Chain of custody on - processor scans and compares slide ID

When the chain of custody is disabled in the Admin Options of the processor, no vial ID, tube ID, nor slide ID information is used by the processor.

When the chain of custody is disabled, a note appears near the top of the processing screens. The note says, “Slide Chain of Custody”, “Aliquot Chain of Custody”, or “All Chain of Custody” depending on the system setting and on what is being processed.

The first step for loading the processor is to load the vial, without entering any vial ID information.

When an aliquot is an item to be processed, the tube is loaded without entering any tube ID information.

When a slide is an item to be processed, the processor does not scan the slide ID.

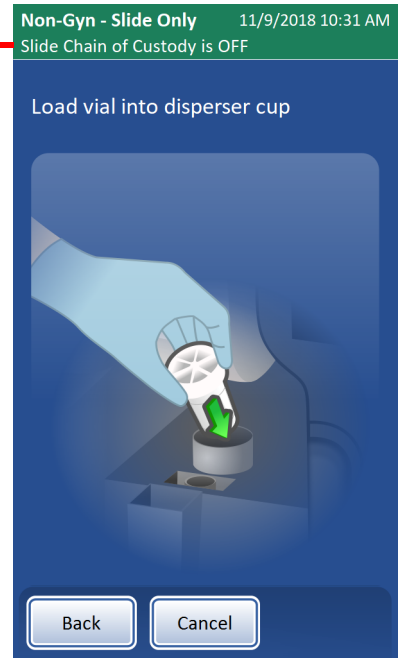

Figure 6-34 Chain of custody off - loading and processing

System Maintenance

On the Admin Options screen, select **System Maintenance** to access the instrument-assisted maintenance steps.

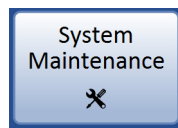

Figure 6-35 System Maintenance button

6

USER INTERFACE

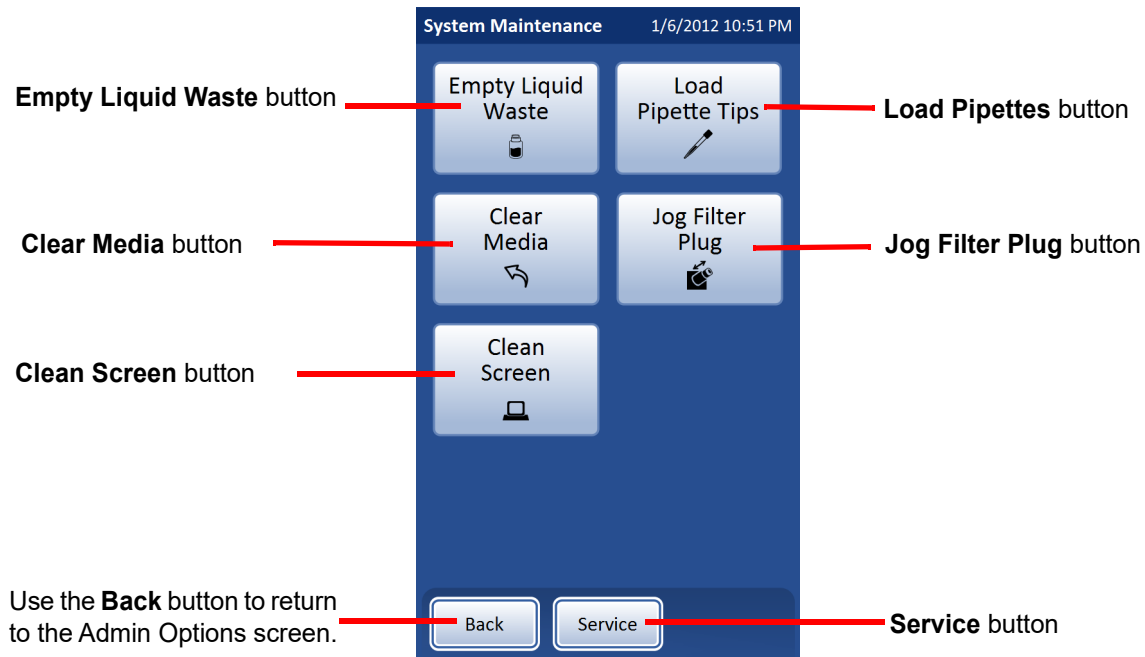
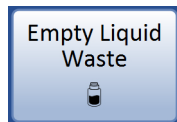

Figure 6-36 System Maintenance screen

Empty liquid waste



The **Empty Liquid Waste** button initiates a series of steps so that the operator can empty the liquid waste bottle. This is described in Chapter 8, Maintenance.

Load pipette tips

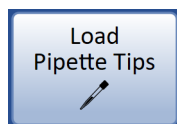

The **Load Pipette Tips** button initiates a series of steps so that the operator can load pipette tips into processor. This is described in Chapter 7, Operating Instructions

Clear media



The **Clear Media** button is used when the operator needs to check the processing path to remove media, such as a filter, vial cap, slide, tube, tube cap, or pipette tip. This is described in Chapter 9, Troubleshooting.

Jog filter plug

The **Jog Filter Plug** button quickly moves (jogs) the filter plug to clean the filter plug and its seal. This is described in Chapter 8, Maintenance

Clean screen

The **Clean Screen** button disables the touch screen for cleaning. This is described in Chapter 8, Maintenance.

Service

The **Service** button is available for Hologic service personnel usage and it is password-protected.

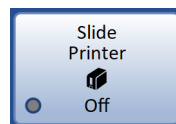
Slide Printer

Slide Printer button shows the current setting.

Figure 6-37 Slide Printer button

The **Slide Printer** button turns on or turns off the communication from the ThinPrep Genesis processor to the optional slide printer. The green circle indicates the "On" setting, and the grey circle indicates the "Off" setting. Press the button to toggle between on and off. Refer to "Slide Labels" on page 6.26 for information about configuring the labels on the slide printer.



USER INTERFACE

Tube Printer

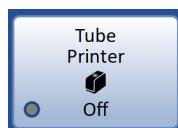

Tube Printer button shows the current setting.

Figure 6-38 Tube Printer button

The **Tube Printer** button turns on or turns off the communication from the ThinPrep Genesis processor to the optional tube printer. The green circle indicates the “On” setting, and the grey circle indicates the “Off” setting. Press the button to toggle between on and off. Refer to “Tube Labels” on page 6.36 for information about configuring the labels on the tube printer.

Slide Labels



Press the **Slide Labels** button to establish or edit the design for the labels printed on the slide printer.

Figure 6-39 Slide Labels button

The Slide Labels feature sets up the label design for the optional slide printer, available from Hologic, for printing on the frosted label area of ThinPrep microscope slides. The slide ID is the primary component of the slide label design.

The Slide ID used in the slide label design is derived from the information for the cytology ID on the sample vial set up in the Configure Barcodes settings. The vial ID must be one of the 1-D or 2-D barcode symbologies supported (Code 128, Interleaved 2 of 5, Code 39, Code 93, EAN/JAN 13, Codabar, DataMatrix or QR Code). No OCR vial label formats may be used. Refer to “Configure Barcodes” on page 6.38 for more information. There are length and character restrictions on the resulting slide ID, based on the selected format and the primary vial ID used.

Other fields on the slide label, such as instrument name, lab name, and the date are derived from the information set up in the System Settings screens. Refer to “System Settings” on page 6.10.

Set the Configure Barcodes settings and the other System Settings before designing the slide labels.

A slide label design is separated into four (4) sections.

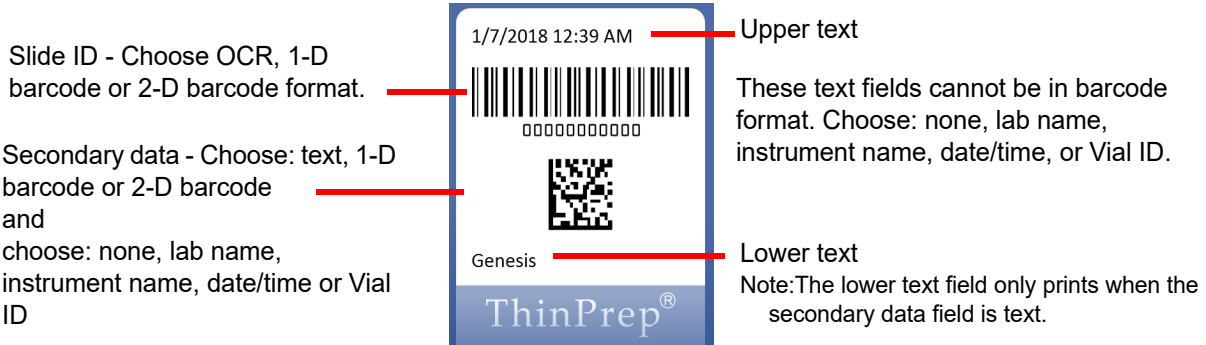

Figure 6-40 Slide label design, example

A slide label design can use a mixture of OCR data and barcodes, along with other information displayed as text. A slide label is too small to fit two barcodes of the same format. The user interface guides the operator through the six (6) steps in the slide label design process.

After the slide label design is saved, a slide label can be printed as a test. The saved label design persists until the operator makes any changes

1. Press the **Edit Design** button. Select the slide ID format. Choose OCR, 1-D barcode, 2-D barcode or Non-Imager OCR.



The graphic shows a rough idea of the appearance and placement of the OCR code.

OCR

For slides that will be run on the ThinPrep Imaging System, this OCR format is required and the slide label is printed in a 7-over-7 format as shown

- Only digits are read from the vial barcode. Non-digit characters are removed.
- If the length is 14, the CRC is assumed to be the last 3 digits. The 11-digit ID is used.
- If the length is between 5–11, zeroes are prefixed as needed to form an 11-digit number.
- If the length is 12 with a leading zero, it is accepted by removing the leading zero.

Figure 6-41 Step 1 - slide ID format - OCR

6

USER INTERFACE

OCR Imager format must be 14-digits long in two rows, 7 digits over 7 digits, with the patient ID being 11 digits and a 3-digit CRC at the end. The font must be 12 point OCR-A. Numbers only, no alpha characters.

Note: For OCR Imager format, '9999' as the last 4 digits before the CRC are reserved for field service use. Slide IDs with those reserved numbers are removed from the patient database during a service visit, so do not use that sequence.

For the 1-D and 2-D barcode types, select the barcode format from the list of available options.

To skip to the end of the Design Slide Labels section at any step without setting any additional design options, press **Finish**.

The graphic shows a rough idea of the appearance and placement of the barcode.

1-D barcode format

- All characters in the vial barcode can be used in the slide 1-D barcode.
- The data length must be between 5 and approximately 14 characters.
- Further slide restrictions may apply to the final format, see Table 6.1

The **Next** button prompts to select which 1-D code is used.

If the barcode format at your facility uses check digits, select **Check digits required**.

Figure 6-42 Step 1 - slide ID format - 1-D barcode

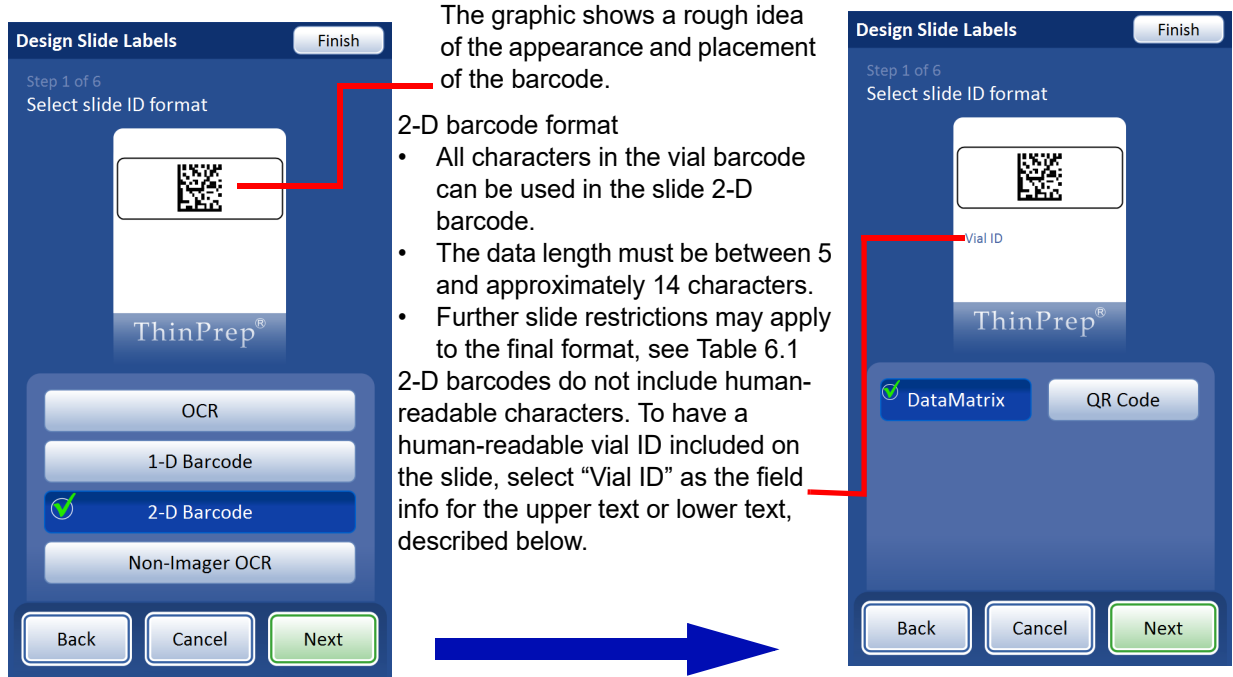
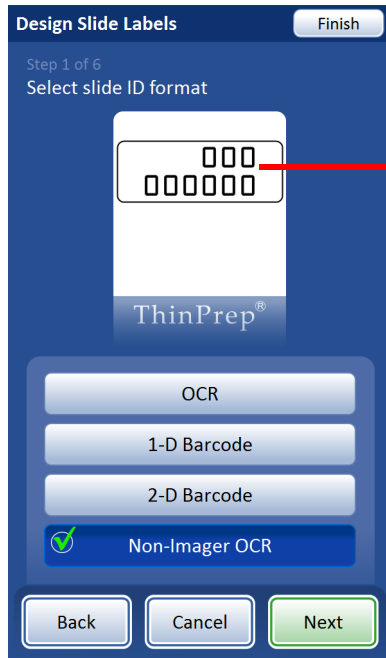

Figure 6-43 Step 1 - slide ID format - 2-D barcode



The graphic shows a rough idea of the appearance and placement of the OCR code.

Non-Imager OCR

The slide is printed on one or two rows, depending how many digits are present in the ID.

- Only digits are read from the vial barcode. Non-digit characters are removed.
- The data length must be between 5 and 14 digits.

Figure 6-44 Step 1 - slide ID format - Non-Imager OCR

The table below describes restrictions based on the various barcode symbologies for slide labels. Vial barcode labels must be 1-dimensional using one of the supported symbologies listed in the table below.

Table 6.1 Slide label restrictions based on barcode symbology used

1-D Code 128	All printable ASCII 128 characters are supported. The barcode width varies with content. Max of 8 alphas or 14 digits will fit on a slide. Mixing will shorten the max length.
1-D Interleaved 2 of 5	Only digits are supported. 5,7,9, or 11 characters +1 check digit is the format.
1-D Code 93	Supported characters are A-Z, 0-9, - + \$ / % 'space' A maximum of 8 characters will fit on a slide.
1-D Code 39	Supported characters are A-Z, 0-9, - + \$ / % 'space' Maximum of 6 characters will fit on a slide.
1-D Codabar	Supported characters are 0-9, : / + . - \$ ABCD are used as start and stop characters.
1-D EAN/JAN-13	Supported characters are 0-9. The code must be 13 digits.
2-D QR	All printable ASCII 128 characters are supported.
2-D DataMatrix	All printable ASCII 128 characters are supported.

2. Select the secondary data format. The secondary data format is the information for the secondary section of the slide label. Choose: none, lab name, instrument name, date/time, or Vial ID.

Consider the symbology when selecting the secondary data format. For example, an instrument name that is a 20-character mix of alpha-numeric characters will not work with a 1-D EAN/JAN-13 barcode symbology, which is a 13-character, numeric symbology. The ThinPrep Genesis processor will display an error message if characters are not supported or if the barcode is too long.

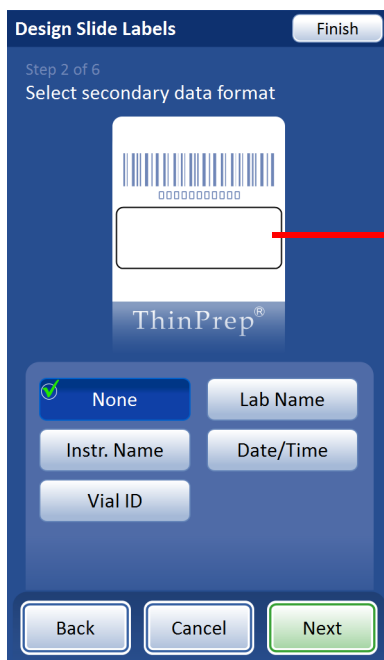

The secondary data field is below the Slide ID.

Select the kind of information to print in the secondary data field.

Refer to “System Settings” on page 6.10 for instructions on setting up the Lab Name, Instrument Name, and Date/Time.

Press **Next** to continue.

Figure 6-45 Step 2 - slide label secondary data format

3. Select the secondary data. This is how the secondary section of the slide label will display the information. Choose: Text, 1-D barcode or 2-D barcode

6

USER INTERFACE

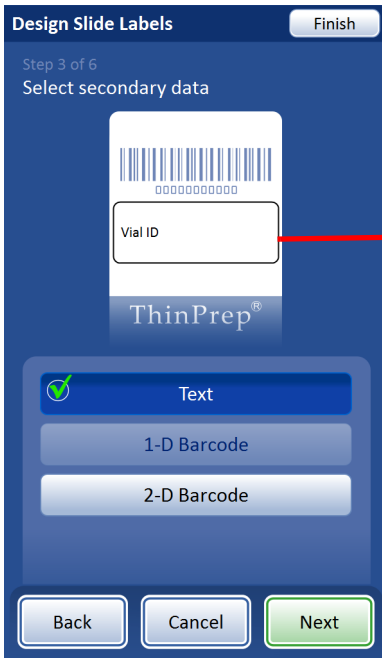

The graphic shows a rough idea of where the text will be placed.

In this example, the secondary data cannot be a 1-D barcode because there is only enough space for one 1-D barcode on the slide label and the slide ID format on this example is in the 1-D barcode format.

In this example, the Vial ID will print on the slide label as text.

Figure 6-46 Step 3 - slide label secondary data: text

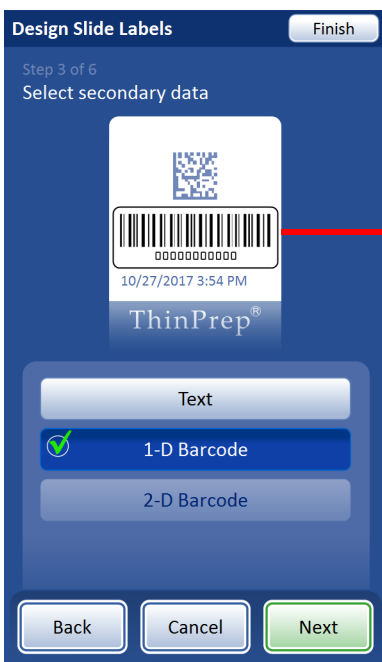

The graphic shows a rough idea of where the secondary data will be placed.

In this example, the secondary data cannot be a 2-D barcode because there is only enough space for one 2-D barcode on the slide label and the slide ID format on this example is in the 2-D barcode format.

Figure 6-47 Step 3 - slide label secondary data: 1-D barcode

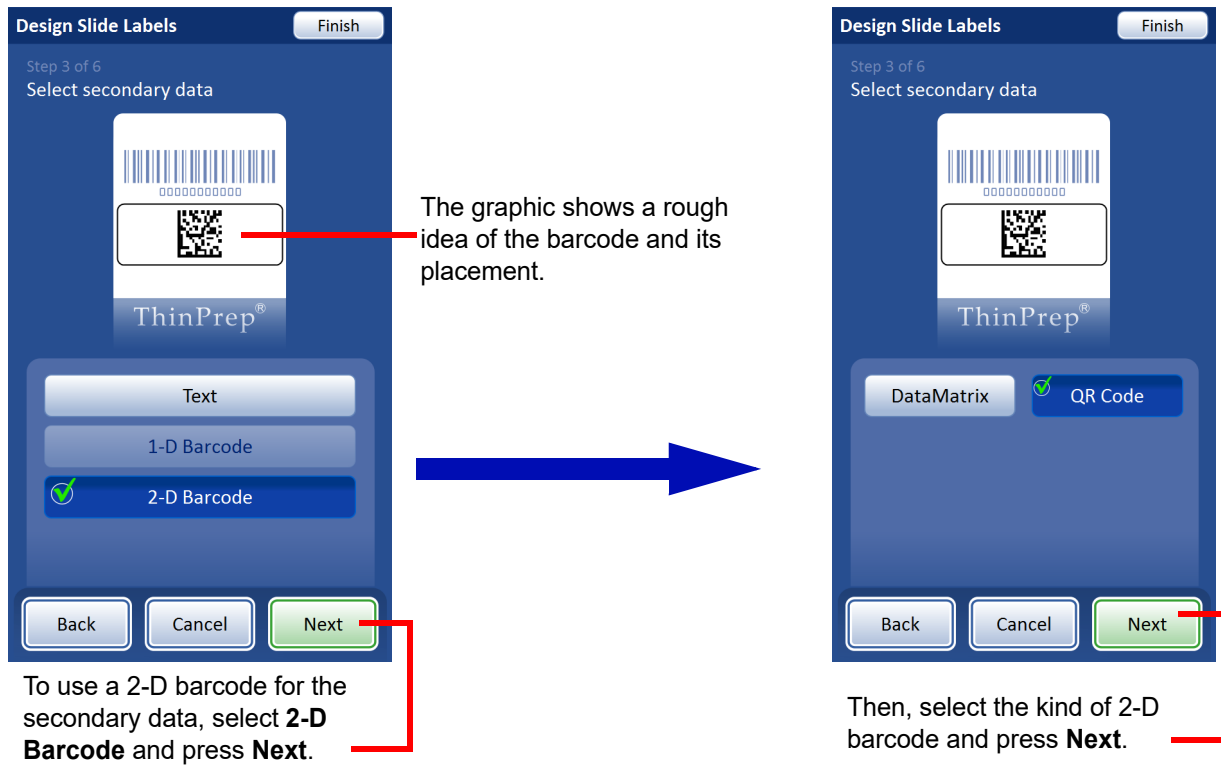

Figure 6-48 Step 3 - slide label secondary data: 2-D barcode

4. Select upper text - The “upper text” is printed above the Slide ID on the slide label. The upper text cannot be a barcode. Choose: none, lab name, instrument name, date/time, or Vial ID.

6

USER INTERFACE



The graphic shows a rough idea of the appearance and placement of the upper text.

Select the kind of information to print in the upper text field.

Refer to “System Settings” on page 6.10 for instructions on setting up the Lab Name, Instrument Name, and Date/Time.

Press **Next** to continue.

Figure 6-49 Step 4 - slide label upper text

5. Select lower text - The “lower text” is printed near the bottom of the frosted area, just above the ThinPrep[®] name on the slide label. The lower text cannot be a barcode. Choose: none, lab name, instrument name, date/time, or Vial ID.



The graphic shows a rough idea of the appearance and placement of the lower text.

Select the kind of information to print in the lower text field.

Refer to “System Settings” on page 6.10 for instructions on setting up the Lab Name, Instrument Name, and Date/Time.

Press **Next** to continue.

Figure 6-50 Step 5 - slide label lower text

6

USER INTERFACE

6. Review the slide label design.

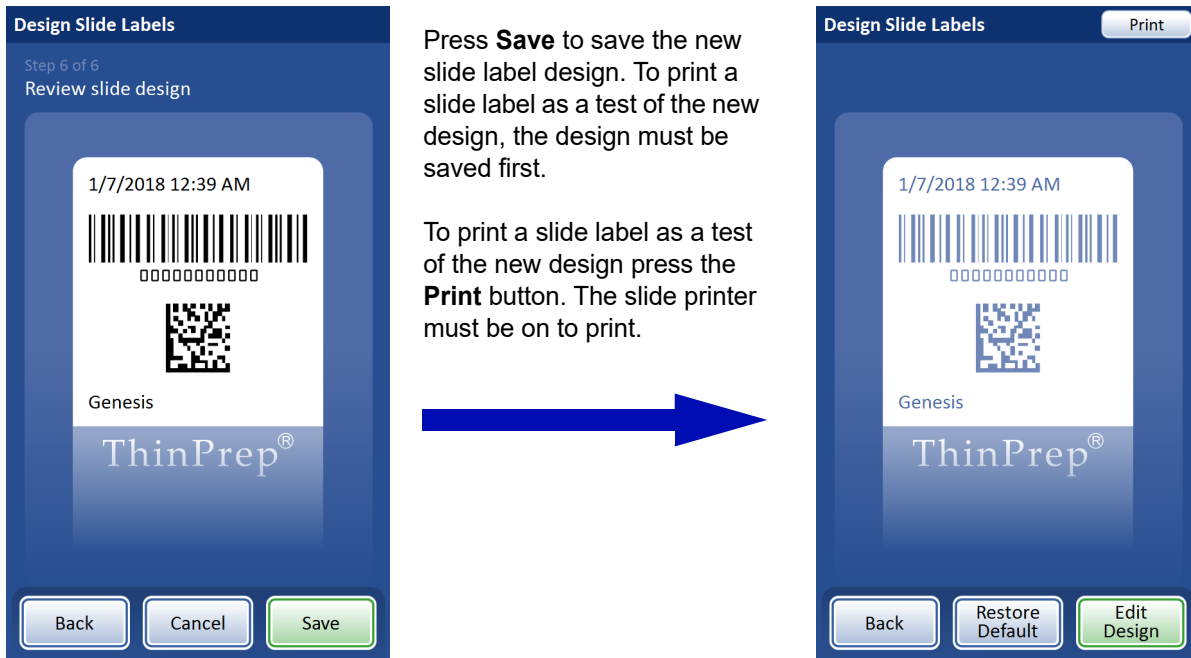

Figure 6-51 Step 6 - review the label design

Tube Labels



Press the **Tube Labels** button to establish or edit the design for the labels printed on the tube printer.

Figure 6-52 Tube Labels button

The Tube Labels feature sets up the label design for the optional tube printer, available from Hologic, for printing a 1-D barcode on the tube label. The tube ID is the only information for the tube label design. The tube ID used in the tube label design is derived from the information for the molecular ID on the sample vial set up in the Configure Barcodes settings. The tube label must be one of the 1-D barcode symbologies supported (Code 128, Interleaved 2 of 5, Code 39, Code 93, EAN/JAN 13, Codabar). No OCR formats nor 2-D barcodes may be used. Refer to “Configure Barcodes” on page 6.38 for more information. See Table 6.2, “Tube label restrictions based on barcode symbology used,” on page 37 for restrictions on the barcode symbology.

Note: If your laboratory uses the same sample vial ID to generate a slide ID label and to generate a tube ID label, apply the slide label restrictions to the tube label. Because the printable area on a slide label is smaller than the printable area on a tube label, an ID that is suitable for a tube label could be too long to fit on a slide label.

Table 6.2 Tube label restrictions based on barcode symbology used

1-D Code 128	All printable ASCII 128 characters are supported. The barcode width varies with content. The limit on the number of characters depends on the mix of alpha and numeric characters. Mixing will shorten the max length.
1-D Interleaved 2 of 5	Only digits are supported. 5,7,9, or 11 characters +1 check digit is the format.
1-D Code 93	Supported characters are A-Z, 0-9, - + \$ / % 'space' The barcode width varies with content. The limit on the number of characters depends on the mix of alpha and numeric characters.
1-D Code 39	Supported characters are A-Z, 0-9, - + \$ / % 'space' The barcode width varies with content. The limit on the number of characters depends on the mix of alpha and numeric characters.
1-D Codabar	Supported characters are 0-9, : / + . - \$ ABCD are used as start and stop characters.
1-D EAN/JAN-13	Supported characters are 0–9. The code must be 13 digits.

6

USER INTERFACE

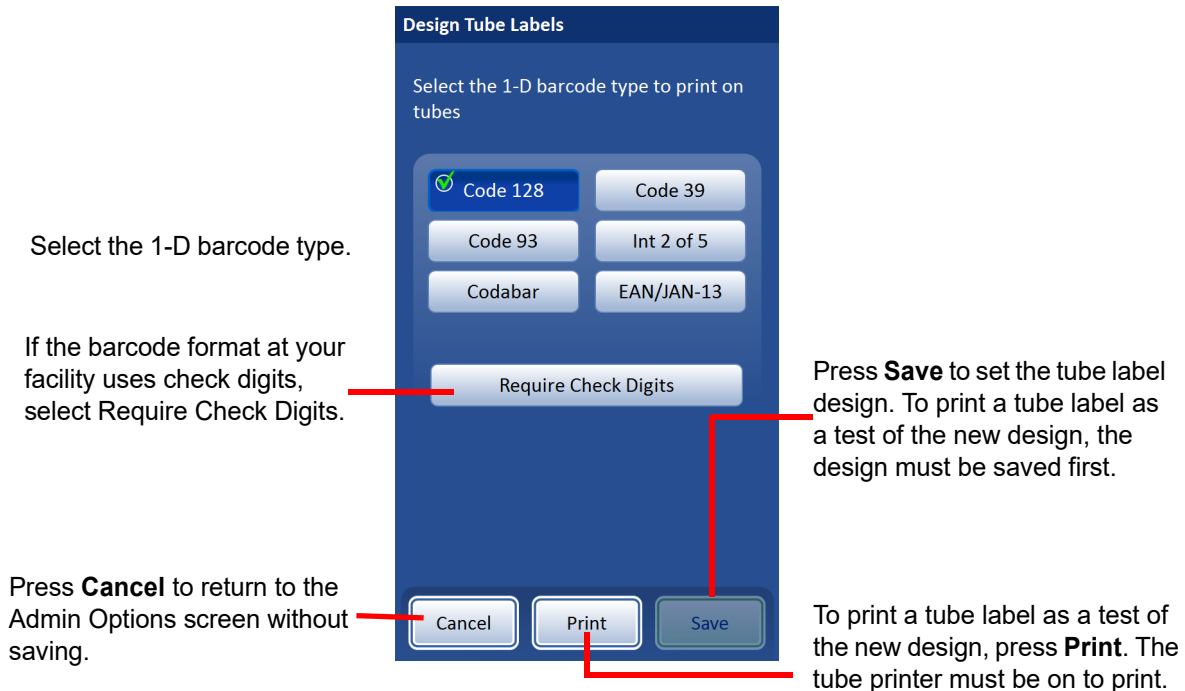

Figure 6-53 Design tube label

Select the type of 1-D barcode to be printed on the tube label. Press **Save** to save the selection.

Configure Barcodes



Figure 6-54 Configure Barcodes button

The ThinPrep Genesis processor compares the ID information on the sample vial with a slide label and/or tube label when the chain of custody is enabled on the processor. The Configure Barcodes option establishes the ways that the processor will compare the ID information. The processor uses information that the operator has already entered on the Slide Labels and/or Tube Labels screens, if data has been entered there. Refer to “Slide Labels” on page 6.26 and “Tube Labels” on page 6.36. And, the operator enters additional configuration information in the Configure Barcodes option.

The Configure Barcodes option has a series of questions about how sample vials are labeled when the vials are prepared for processing, a series of questions about how a slide is labeled, and a series of questions about how a tube is labeled in your laboratory.

To use the ThinPrep Genesis System of the processor, the slide printer and/or the tube printer, the settings in the following Admin Options need to be set up: Configure Barcodes, Slide Labels, Tube Labels, Slide Printer On, Tube Printer On.

To use the chain of custody feature on the ThinPrep Genesis processor without the optional slide printer nor optional tube printer, the information in the Configure Barcodes option needs to be set up.

Note: The Configure Barcodes settings require that a portion of the information in the ID used on the sample vial is also used on a slide label and/or on a tube label. The ID on the sample vial can be the same ID that is used on a slide and/or tube.

If your laboratory does not use the chain of custody feature, there is no need to configure barcodes.

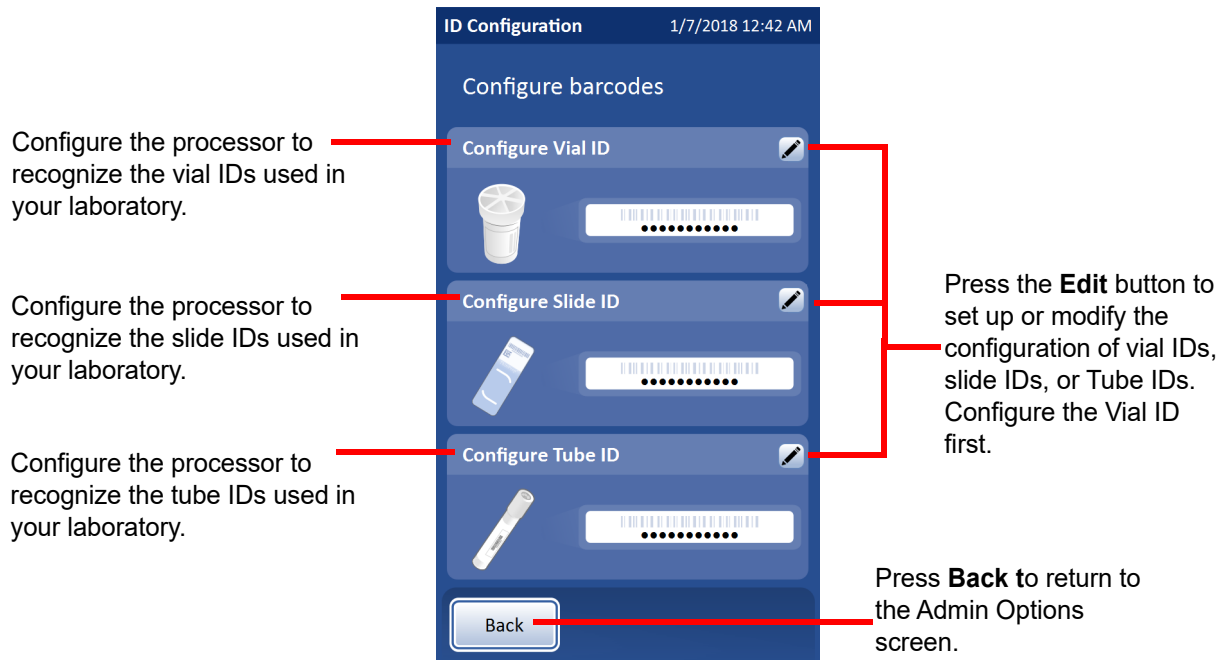

Figure 6-55 Configure barcodes ID configuration

There are separate sections for configuring the vial ID, the slide ID and the tube ID. In each of the sections, information about the IDs must be entered. Each section ends with a screen with a **Test Configuration** button that lets you scan example labels from a vial, slide or tube to check that the ThinPrep Genesis processor is configured to read the ID labels used in your lab.

On the ThinPrep Genesis processor, the screen displays are designed to guide the operator through the sequence of steps to configure all of the barcode information. The sequence of steps is different if the slide printer and/or tube printer is/are used. The sequence of steps is also different if the slide IDs and/or tube IDs are exactly the same as the vial IDs. Each of the steps is described below, followed by the full sequence of steps for configuring the vial ID, the slide ID, and the tube ID.

Select ID barcode types

In the Configure Barcodes option, the steps for selecting the ID type are the same when they describe vial IDs, slide IDs, or tube IDs. The selection can be one type or it can be any combination of the barcode types and OCR formats supported by the ThinPrep Genesis processor.

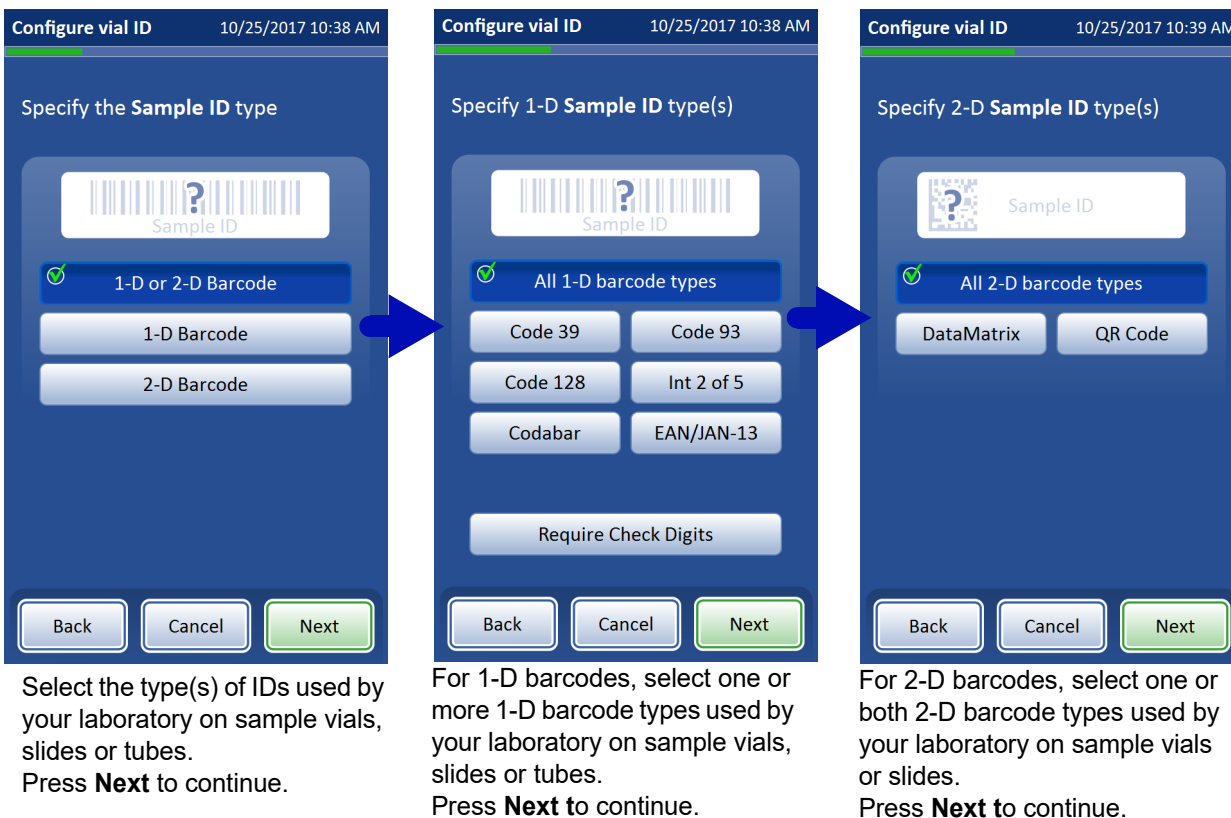

This example shows the vial ID options for a laboratory that uses a single barcode for cytology and molecular IDs.

Figure 6-56 Configure barcodes - select ID types

The selection of ID types is the same whether the vial has a single barcode for cytology and molecular IDs or not. The description of the vial ID is "Sample ID", "Cytology ID", or "Molecular ID".

The selection of slide ID types is similar, and includes the OCR and Non-Imager OCR formats.

The selection of tube ID types is similar, and does not include the 2-D barcode options.

If the vial ID requires check digits, then the slide ID and tube ID must also require check digits. If the vial ID does not use check digits, then the slide ID and tube ID also must not use check digits.

Unique characteristics of a vial ID

The steps that identify unique characteristics in a vial label ID are the same when they describe a Sample ID, Cytology ID or Molecular ID.

These characteristics are the criteria that the ThinPrep Genesis processor uses to determine if the vial ID scanned or entered during processing is in the correct format. If an ID with different characteristics is entered when the instrument is processing a sample, an orange “unexpected ID” message notifies the operator.

Set up as few or as many of the unique characteristics as necessary to properly distinguish the information that you want the ThinPrep Genesis processor to use from information that you do not want the processor to use. If there are no unique characteristics in the ID because an unlimited variety of IDs are acceptable in your laboratory, use the characteristic called “None”.

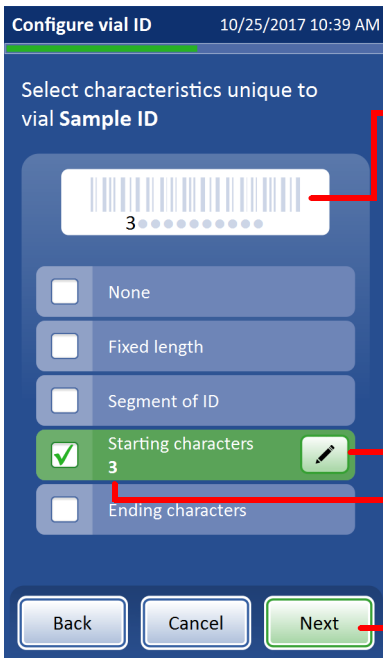

The graphic shows a rough idea of the appearance and placement of the unique characteristic in the ID.

Touch the box to the left of name of the characteristic to select or deselect it.

When a characteristic is selected, an **Edit** button (✎) appears. Press the **Edit** button to access and edit the details of that characteristic.

A summary of the details appears below the name of the characteristic.

After characteristics are changed, or to continue from this screen without making changes, press **Next**.

This example shows the Sample ID. These instructions are the same for the Cytology ID and the Molecular ID.

Figure 6-57 Configure barcodes - select unique characteristics



The selection of unique characteristics in a vial ID is the same whether the vial has a single barcode for cytology and molecular IDs or not. The description of the vial ID is “Sample ID”, “Cytology ID”, or “Molecular ID”.

Table 6.3 Unique Characteristics in Vial IDs, Examples

Characteristic	Examples of Vial IDs
Fixed Length	
If the vial IDs are always the same number of characters, consider using the Fixed Length characteristic.	<p>123456789 223456789 323456789</p> <p>These IDs always have 9 characters. Consider setting a Fixed Length of 9.</p>
Segment of ID	
If vial IDs are always the same characters in the middle of the ID, consider using the Segment of ID characteristic.	<p>ABC-1234-DEF GHI-1234-JKL MNO-1234-PQR</p> <p>The data between the hyphens is always the same in these IDs. Consider setting a Segment of ID that starts at character “-” and ends at character “-”.</p>
Starting Characters	
If vial IDs always start with the same characters, consider using the Starting Characters characteristic.	<p>LAB123456 LABABCDEFGH LAB-A1b2C3d4</p> <p>These IDs all start with the same 3 characters. Consider setting “LAB” as the Starting Characters. Alternatively, a Segment of ID from position 1 to position 3 could also be used.</p>
Ending Characters	
If vial IDs always end with the same characters, consider using the Ending Characters characteristic.	<p>123456789 23456789 3456789</p> <p>These IDs are different lengths. Consider setting “789” as the Ending Characters.</p>

None - use this option if there is nothing that all vial IDs have in common.

1. Touch the box to the left of the name of the characteristic to select it.
2. Press **Next** to continue.

Fixed length - if the ID on any vial always has the same number of characters, consider using the fixed length as a unique characteristic in the barcode configuration information. The fixed length must be between 5 and 64 characters.

1. Touch the box to the left of the name of the characteristic to select it.
2. Touch the **Edit** button to edit the details.
3. Touch the empty box to access the keypad.
4. Use the keypad to enter the number of characters in the ID length box.
5. Press **Done** to close the keypad.
6. Press **Save** to save the ID length.

Segment of ID - if the ID on any vial has a portion of the ID that is always the same, consider using that segment of the ID as a unique characteristic in the barcode configuration information.

If the unique segment is always at the start or always at the end of the ID on the vial, it may be easier to use the starting characters or ending characters as a unique characteristic, but the segment of ID characteristic can be used.

If vial IDs have a segment that is always the same and the vial IDs always have a fixed length, consider using either the Segment of ID or the Fixed length characteristic, but not both.

1. Touch the box to the left of the name of the characteristic to select it.
2. Touch the **Edit** button to edit the details.
3. Indicate where the start of the unique segment is in the ID.
If the starting point is a certain position in the ID on the vial, such as the fifth character, use the "Start at position" setting.
 - A. Touch the empty box to access the keypad.
 - B. Use the keypad to enter the number that represents the position of the character which is the start of the unique segment, such as "5" for the fifth character.If the starting point of the unique segment of the ID on the vial is a certain character, touch the triangle next to "Start at position" to see the "Start at character" option.
 - A. Touch the name **Start at character** to select it.
 - B. Touch the empty box to access the keypad.
 - C. Use the keypad to enter the character that starts the unique segment of the ID. This character is treated like a boundary, and this character is not included when the unique segment of the vial ID is used in other areas of the Configure Barcodes settings.
4. Indicate where the end of the unique segment is in the ID on the vial.
If the ending point of the unique segment of the ID on the vial is always the same number of characters from the starting point of the unique segment, use the "Segment length" field.
 - A. Touch the empty box to access the keypad.



USER INTERFACE

- B. Use the keypad to enter the number that represents the position which is the end of the unique segment of the ID, such as “7” for the seventh character from the start of the segment.

If the ending point of the unique segment of the ID on the vial is a certain character, touch the triangle next to “Segment length” to see the “End at character” option.

- A. Touch the name **End at character** to select it.
 - B. Touch the empty box to access the keypad.
 - C. Use the keypad to enter the character that ends the unique segment of the ID. This character is treated like a boundary, and this character is not included when the unique segment of the vial ID is used in other areas of the Configure Barcodes settings.
5. Press **Done** to close the keypad.
 6. Press **Save** to save the details.

Starting characters - if the ID on the vial or the unique segment of the vial ID always starts with the same character(s), consider using the starting characters as a unique characteristic in the barcode configuration information.

1. Touch the box to the left of the name of the characteristic to select it.
2. Touch the **Edit** button to edit the details.
3. Touch the “Starting characters” box to access the keypad.
4. Use the keypad to enter the character or characters that are always at the start of the ID or the start of the unique segment of the vial ID.
5. Press **Done** to close the keypad.
6. Press **Save** to save the starting characters information.

Ending characters - if the ID on the vial or the unique segment of the vial ID always ends with the same character(s), consider using the ending characters as a unique characteristic in the barcode configuration information.

1. Touch the box to the left of the name of the characteristic to select it.
2. Touch the **Edit** button to edit the details.
3. Touch the “Ending characters” box to access the keypad.
4. Use the keypad to enter the character or characters that are always at the end of the ID or the end of the unique segment of the vial ID.
5. Press **Done** to close the keypad.
6. Press **Save** to save the starting characters information.

What the slide ID or tube ID looks like

These characteristics are criteria that the ThinPrep Genesis processor uses to determine if the slide ID or the tube ID scanned or entered during processing is in the correct format. If an ID with different characteristics is entered when the instrument is processing a sample, an orange “unexpected ID” message notifies the operator. These characteristics apply to tube IDs and slide IDs that are in a 1-D barcode format. These characteristics also apply to slide IDs that are in a 2-D barcode format. Do not use these characteristics for slide labels in OCR format.

Use as many of the fields as necessary to properly describe the ways that the slide ID or tube ID differs from the vial ID. If the slide ID is the same as the ID on the vial, or if the tube ID is the same as the ID on the vial, this step is not in the sequence of steps.

The steps that describe the relationship of slide IDs or tube IDs to vial label IDs are the same when they describe slide IDs or tube IDs.

Table 6.4 What the ID Looks Like, Examples

Examples of Vial IDs	Examples of Slide IDs These instructions also apply to Tube IDs.
Segment of ID	
12-34-56789 12-34-ABCDEF	34-567 34-ABC A segment of characters in the middle of the vial ID is the same as the entire slide ID. Consider setting the Segment of ID starting at the character "-".
Replace Characters	
12-34-56789 12-AB-98765	12-ABC-56789 12-ABC-98765 Characters in the Vial ID are replaced in the Slide ID. Consider using Replace Characters , starting at position 3 and ending a character "-".
Insert Characters	
12-34-56789 5678ABC	12312-34-56789 1235678ABC The same characters are added to the beginning of the Vial ID to make the Slide ID. Consider setting the Insert Characters setting to add the characters that always end the Slide ID. In this example "123" is inserted in the Vial ID to make the Slide ID.



Table 6.4 What the ID Looks Like, Examples

Examples of Vial IDs	Examples of Slide IDs These instructions also apply to Tube IDs.
Append Characters	
<p>12-34-56789 5678ABC</p>	<p>12-34-56789123 5678ABC123</p> <p>The same characters are added to the end of the Vial ID to make the Slide ID. Consider setting the Append Characters setting to add the characters that always end the Slide ID. In this example “123” is appended to the Vial ID to make the Slide ID.</p>

Segment of ID - if the slide ID is a portion of the vial cytology ID, use the “Segment of ID” option. If the tube ID is a portion of the vial molecular ID, use the “Segment of ID” option.

1. Touch the box to the left of the name to select it.
2. Touch the **Edit** button to edit the details.
3. Indicate where, in the vial ID, the segment that is used on the slide ID (or the tube ID) starts. If the starting point is a certain position in the ID on the vial, such as the fifth character, use the “Start at position” setting.
 - A. Touch the empty box to access the keypad.
 - B. Use the keypad to enter the number that represents the position of the character which is the start of the unique segment, such as “5” for the fifth character.

If the starting point of the segment of the ID on the vial is a certain character, touch the triangle next to “Start at position” to see the “Start at character” field.

 - A. Touch the name **Start at character** to select it.
 - B. Touch the empty box to access the keypad.
 - C. Use the keypad to enter the character that starts the unique segment of the ID. This character is treated like a boundary, and this character is not included when the unique segment of the vial ID is used in other areas of the Configure Barcodes settings.
 - D. Press **Done** to close the keypad.
4. Indicate where, in the vial ID, the segment that is used on the slide ID ends. If the ending point of the segment of the ID on the vial is always the same number of characters from the starting point of the segment, use the “Segment length” field.
 - A. Touch the empty box to access the keypad.
 - B. Use the keypad to enter the character that ends the unique segment of the ID.

If the ending point of the segment of the ID on the vial is a certain character, touch the triangle next to “Segment length” to see the “End at character” field.

- A. Touch the name **Segment length** to select it.
 - B. Touch the empty box to access the keypad.
 - C. Use the keypad to enter the character that ends the unique segment of the ID. This character is treated like a boundary, and this character is not included when the unique segment of the vial ID is used in other areas of the Configure Barcodes settings.
 - D. Press **Done** to close the keypad.
5. Press **Save** to save the details.

Replace characters - if the difference between the slide ID and the cytology ID on the sample vial is that some characters in the vial ID are replaced, use the “Replace characters” option. If the difference between the tube ID and the molecular ID on the sample vial is that some characters in the vial ID are replaced, use the “Replace characters” option.

1. Touch the box to the left of the name to select it.
2. Touch the **Edit** button to edit the details.
3. Touch the “Characters to replace” box to access the keypad.
4. Use the keypad to enter the characters in the vial ID that are replaced in the slide ID (or the tube ID).
5. Touch the “New characters” box and use the keypad to enter the characters that are in the slide ID (or the tube ID), replacing characters in the vial ID.
6. Press **Done** to close the keypad.
7. Press **Save** to save the starting or inserted characters’ information.

Insert characters - if the slide ID is the cytology ID on the sample vial with characters added to the beginning of the cytology ID on the sample vial, use the “Insert Characters” option. If the tube ID is the molecular ID on the sample vial with characters added to the beginning of the molecular ID on the sample vial, use the “Insert Characters” option.

1. Touch the box to the left of the name to select it.
2. Touch the **Edit** button to edit the details.
3. Touch the “Starting characters” box to access the keypad.
4. Use the keypad to enter the character or characters that are always at the start the slide ID.
5. Press **Done** to close the keypad.
6. Press **Save** to save the starting or inserted characters’ information.

Append characters - if the slide ID is the cytology ID on the sample vial with characters added to the end of the cytology ID on the sample vial, use the “Append Characters” option. If the tube ID is the molecular ID on the sample vial with characters added to the end of the molecular ID on the sample vial, use the “Append Characters” option.

1. Touch the box to the left of the name to select it.
2. Touch the **Edit** button to edit the details.
3. Touch the “Ending characters” box to access the keypad.



USER INTERFACE

4. Use the keypad to enter the character or characters that are always at the end the slide ID (or the tube ID).
5. Press **Save** to save the ending or appended characters' information.

How the vial ID matches the slide ID or tube ID

If the laboratory uses the chain of custody feature but does not use the optional slide printer or the optional tube printer, the operator must enter information describing how the vial ID is related to the slide ID, or how the vial ID is related to the tube ID, so that the processor has some criteria for checking that the IDs are in the correct format.

1. "What part of the vial ID will match the slide ID?" or "What part of the vial ID will match the tube ID?"

Entire ID - use this option if the entire vial ID is part of the slide ID or tube ID. Touch the box to the left of the name to select it.

Segment of ID - use this option if only a portion of the vial ID is used on the slide ID or tube ID.

- A. Touch the box to the left of the name to select it.
- B. Touch the **Edit** button to edit the details. The data entered in the Configure Vial ID information is suggested as the segment of the vial ID that matches the slide ID, or matches the tube ID.
- C. Touch the **Edit** button to make changes.
- D. Indicate where, in the vial ID, the segment that is used on the slide ID or the tube ID starts.

If the starting point is a certain position in the ID on the vial, such as the fifth character, use the "Start at position" setting.

- i. Touch the empty box to access the keypad.
- ii. Use the keypad to enter the number that represents the position of the character which is the start of the unique segment, such as "5" for the fifth character.

If the starting point of the segment of the ID on the vial is a certain character, touch the triangle next to "Start at position" to see the "Start at character" field.

- i. Touch the name **Start at character** to select it.
- ii. Touch the empty box to access the keypad.
- iii. Use the keypad to enter the character that starts the unique segment of the ID. This character is treated like a boundary, and this character is not included when the unique segment of the vial ID is used in other areas of the Configure Barcodes settings.
- iv. Press **Done** to close the keypad.

- E. Indicate where, in the vial ID, the segment that is used on the slide ID (or the tube ID) ends.

If the ending point of the segment of the ID on the vial is always the same number of characters from the starting point of the segment, use the "Segment length" field.

- i. Touch the empty box to access the keypad.
- ii. Use the keypad to enter the character that starts the unique segment of the ID.

If the ending point of the segment of the ID on the vial is a certain character, touch the triangle next to “Segment length” to see the “End at character” field.

- i. Touch the name **End at character** to select it.
- ii. Touch the empty box to access the keypad.
- iii. Use the keypad to enter the character that ends the unique segment of the ID. This character is treated like a boundary, and this character is not included when the unique segment of the vial ID is used in other areas of the Configure Barcodes settings.
- iv. Press **Done** to close the keypad.

F. Press **Save** to save the details.

2. “What part of the slide ID will match the vial ID?” or “What part of the tube ID will match the vial ID?”

Entire ID - use this option if the entire slide ID or the entire tube ID is part of the vial ID. Touch the box to the left of the name to select it.

Segment of ID - use this option if only a portion of the slide ID or tube ID is used on the vial ID.

A. Touch the box to the left of the name to select it.

B. Touch the **Edit** button to edit the details.

C. Indicate where, in the slide ID or tube ID, the segment that matches the vial label starts.

If the starting point is a certain position in the slide ID or tube ID, such as the fifth character, use the “Start at position” setting.

- i. Touch the empty box to access the keypad.
- ii. Use the keypad to enter the number that represents the position of the character which is the start of the unique segment, such as “5” for the fifth character.

If the starting point of the segment of the slide ID or tube ID is a certain character, touch the triangle next to “Start at position” to see the “Start at character” field.

- i. Touch the name **Start at character** to select it.
- ii. Touch the empty box to access the keypad.
- iii. Use the keypad to enter the character that starts the unique segment of the ID. This character is treated like a boundary, and this character is not included when the unique segment of the slide ID or tube ID is used in other areas of the Configure Barcodes settings.
- iv. Press **Done** to close the keypad.

D. Indicate where, in the slide ID or tube ID, the segment that is used on the vial ID ends.

If the ending point of the segment of the ID is always the same number of characters from the starting point of the segment, use the “Segment length” field.

- i. Touch the empty box to access the keypad.
- ii. Use the keypad to enter the character that starts the unique segment of the ID. Since the processor will be checking that the segment on the slide ID or tube ID matches a segment of the vial ID, the length for this segment has to be the same as the vial ID segment.

If the ending point of the segment of the ID is a certain character, touch the triangle next to “Segment length” to see the “End at character” field.



USER INTERFACE

- i. Touch the name **End at character** to select it.
 - ii. Touch the empty box to access the keypad.
 - iii. Use the keypad to enter the character that ends the unique segment of the ID. This character is treated like a boundary and this character is not included when the unique segment of the slide ID or tube ID is used in other areas of the Configure Barcodes settings.
 - iv. Press **Done** to close the keypad.
3. Press **Save** to save the details.

Review and save the configuration

The sequence of steps for configuring the vial ID, for configuring the slide ID, and for configuring the tube ID, ends with a “Review and save configuration” screen. Use the **Test Configuration** button to test if the configuration on the ThinPrep Genesis processor for the vial ID, slide ID or tube ID is correct for vials, slides, or tubes used in your laboratory,

1. Press the **Test Configuration** button and the scanner on the processor flashes its red light, ready to scan a vial ID as a test.
2. Open the processor door and scan the requested ID label, or manually enter the ID using the keypad.
 - For the Configure Vial ID sequence, if the configuration is set to expect one ID for a vial’s cytology ID and a second ID for the vial’s molecular ID, scan or enter each of the two IDs.
 - For the Configure Slide ID sequence, to see a preview of the Slide ID, scan or manually enter the vial’s cytology ID or sample ID. If the vial ID is in the format configured on the processor, a green check mark appears next to the ID on the screen. The preview of the Slide ID appears in the Slide ID field on the screen.

If the configuration is set to use the slide printer (the slide is not already printed), the Test Configuration screen has a **Print** button. With the slide printer ready and loaded with slides, press **Print** to print an example of an ID on a slide as configured. Press **Close** to return to the Configure Slide ID screen.
 - For the Configure Tube ID sequence, to see a preview of the Tube ID, scan or manually enter the vial’s molecular ID or sample ID. If the vial ID is in the format configured on the processor, a green check mark appears next to the ID on the screen. The preview of the Tube ID appears in the Tube ID field on the screen.

If the configuration is set to use the tube printer (the tube is not already printed), the Test Configuration screen has a **Print** button. With the tube printer ready, press **Print** to print an example of an ID on a tube as configured. Press **Close** to return to the Configure Tube ID screen.
3. If the configuration on the processor is now appropriate for your laboratory, press **Save** to save the configuration.

If the configuration has not been set up correctly on the processor, or if the wrong ID is entered, an orange “Unexpected ID” notice appears when the vial ID is scanned or entered. Use the **Back** button to navigate to the screen to correct the configuration, or enter an ID from a correct vial.

Configure vial ID

In the Configure Vial ID steps, the operator enters information describing the IDs used on vial labels. The processor stores this information and uses it for during processing and in reports.

If the laboratory uses a single barcode label on the sample vial, the sequence of steps for configuring the vial ID uses the term “Sample ID”.

If the laboratory uses one barcode label on the sample vial for cytology and a separate barcode label on the sample vial for testing from the tube, the sequence of steps for configuring the vial ID uses the term “Cytology ID” and “Molecular ID”. The processor prompts the user to configure the vial ID for each kind of vial ID that will be used by the processor.

1. Press **Edit** on the Configure Vial ID section.

Select **No** if a vial does not have just one barcode for both cytology and molecular identification.

“No” means that a vial has one barcode for cytology identification and a separate barcode for molecular identification.

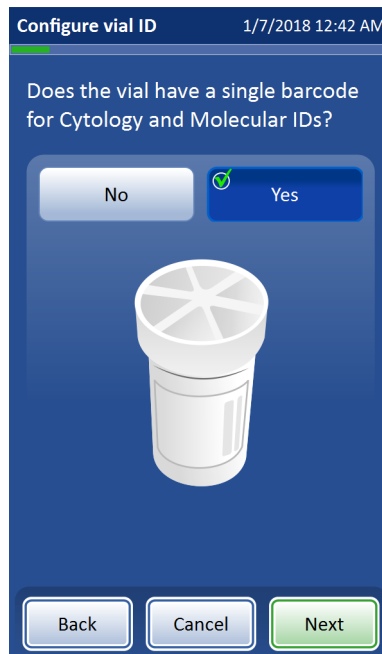

Select **Yes** if a vial uses one barcode for both cytology and molecular identification.

Press **Next** to continue.

Figure 6-58 Configure vial ID

2. Select **No** or **Yes** to the question, “Does the vial have a single barcode for Cytology and Molecular IDs?” Press **Next**.

If vials that will be processed on the ThinPrep Genesis processor always only have a single barcode ID label on them, the screen display and the reports refer to the vial ID as the “Sample



USER INTERFACE

ID". The next step for configuring the vial ID is to enter information about the barcode type(s) used on the sample ID on the vial.

If vials that will be processed on the ThinPrep Genesis processor always have one barcode ID label for cytology and a separate barcode ID label for molecular testing, the screen display and the reports refer to the vial ID for cytology as the "Cytology ID" and the vial ID for molecular testing as the "Molecular ID." The next step for configuring the vial ID is to enter information about the barcode type(s) used on the cytology ID on the vial, followed by entering information about the molecular ID on the vial.

3. Select the barcode types that are used on vial labels in your lab. Refer to "Select ID barcode types" on page 6.40. Press **Next**.
4. Select one or more characteristic that is unique to the vial ID. Refer to "Unique characteristics of a vial ID" on page 6.41. Press **Next**.
5. Review the configuration. To test the configuration, press the **Test Configuration** button. Refer to "Review and save the configuration" on page 6.50. Press **Save** to save the vial ID configuration.

If your laboratory uses one barcode for cytology IDs on vials and a separate barcode for molecular IDs on vials, steps 3-5 above are repeated. The settings for the Cytology ID are configured first, and then the settings for the Molecular ID are configured.

Configure the slide ID

The ThinPrep Genesis processor can be configured to check that the Slide ID is based on the ID on the sample vial. The relationship between the Slide ID and the ID on the vial is customizable to the practices used in your laboratory. A portion of the slide ID must come from ID on the sample vial, and the Slide ID can be identical to the ID on the sample vial. Use the Configure Slide ID feature to set up and store the Slide ID configuration on the processor.

1. Press **Edit** () on the Configure Slide ID section. Refer to Figure 6-55.

Select **No** if the slide printer in the ThinPrep Genesis system will print the slide ID.

Select **No** if the ID on the slide is not the same as the cytology ID on the sample vial.

Select **Yes** if the slide ID is not printed by the slide printer in the ThinPrep Genesis system.

Select **Yes** if the ID on the slide is the same as the cytology ID on the sample vial. The barcode format of the slide ID and vial ID can be different and still represent the same ID.

Press **Next** to continue.

Figure 6-59 Configure barcodes - configure slide ID

2. Select **No** or **Yes** to the questions, “Is the barcode already printed on the slide?” and, “Is the slide ID identical to the vial Cytology ID?” Press **Next**.
3. If the barcode is already printed on the slide, the next step is to enter information about the format of the slide ID. Refer to “Select ID barcode types” on page 6.40. Press **Next**. If the slide ID is identical to the vial Cytology ID, the next step is to review the configuration (step 5).

If the barcode is not already printed on the slide, the ThinPrep Genesis system will use the slide ID type from the design information stored on the processor. Refer to “Slide Labels” on page 6.26.

4. If the slide ID is not identical to the cytology ID on the sample vial, describe how the slide ID and vial ID differ. Refer to “What the slide ID or tube ID looks like” on page 6.44 if the barcode is not already printed on the slide. Refer to “How the vial ID matches the slide ID or tube ID” on page 6.48 if the barcode is already printed on the slide. Press **Next**.
5. Review the configuration. To test the configuration, press the **Test Configuration** button. Refer to “Review and save the configuration” on page 6.50. Press **Save** to save the slide ID configuration.

6

USER INTERFACE

Configure the tube ID

The ThinPrep Genesis processor can be configured to check that the Tube ID is based on the ID on the sample vial. The relationship between the Tube ID and the ID on the vial is customizable to the practices used in your laboratory. A portion of the tube ID must come from ID on the sample vial, and the tube ID can be identical to the ID on the sample vial. Use the Configure Tube ID feature to set up and store the Tube ID configuration on the processor.

1. Press **Edit** (✎) on the Configure Tube ID section. Refer to Figure 6-55.

Select **No** if the tube printer in the ThinPrep Genesis system will print the tube.

Select **No** if the ID on the tube is not the same as the molecular ID on the sample vial.

The screenshot shows a mobile application interface for configuring tube IDs. The title bar reads 'Configure tube ID' and the time is '1/7/2018 12:57 AM'. The main content area has a blue background and contains two questions, each with a 'No' button (highlighted with a green checkmark) and a 'Yes' button. The first question is 'Is the barcode already printed on the tube?' with an image of a tube. The second question is 'Is the tube ID identical to the vial Molecular ID?' with an image of a vial and a tube. At the bottom, there are three buttons: 'Back', 'Cancel', and 'Next' (highlighted with a green border).

Select **Yes** if the tube ID is not printed by the tube printer in the ThinPrep Genesis system.

Select **Yes** if the ID on the tube is the same as the molecular ID on the sample vial. The barcode format of the tube ID and vial ID can be different and still represent the same ID.

Press **Next** to continue.

Figure 6-60 Configure barcodes - configure tube ID

2. Select **No** or **Yes** to the questions, “Is the barcode already printed on the tube?” and, “Is the tube ID identical to the vial Molecular ID?” Press **Next**.
3. If the barcode is already printed on the tube, the next step is to enter information about the format of the tube ID. Refer to “Select ID barcode types” on page 6.40. Press **Next**. If the barcode is not already printed on the tube, the ThinPrep Genesis system will use the tube ID type from the design information stored on the processor. Refer to “Tube Labels” on page 6.36.
4. If the tube ID is not identical to the molecular ID on the sample vial, describe how the tube ID and vial ID differ. Refer to “What the slide ID or tube ID looks like” on page 6.44. Refer to “What the slide ID or tube ID looks like” on page 6.44 if the barcode is not already printed on the tube.

Refer to “How the vial ID matches the slide ID or tube ID” on page 6.48 if the barcode is already printed on the tube.

Press **Next**.

5. Review the configuration. To test the configuration, press the **Test Configuration** button. Refer to “Review and save the configuration” on page 6.50. Press **Save** to save the tube ID configuration.

About

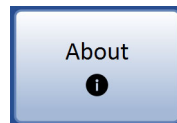

Figure 6-61 About button

Press the **About** button to display the serial number for the ThinPrep Genesis processor as well as software version information. The information displays for several seconds and then the System Settings screen returns.

6

USER INTERFACE

Reports

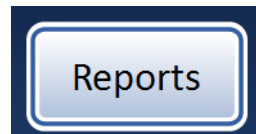

The **Reports** button is on the main menu.

Figure 6-62 Reports button

The Reports interface presents system information in three forms:

- **Vial Reports** - displays the success or failure of sample processing for each vial processed.
- **System Events** - a log of all system errors, excluding sample preparation errors that do not interfere with the operation of the processor. The record of errors is retained for three years; errors older than three years are purged.
- **Usage Details** - indicates the number of vials successfully processed to date, for cytology samples by sequence type, and for molecular samples.

The ThinPrep Genesis processor can save each kind of report to a USB drive in xml format.

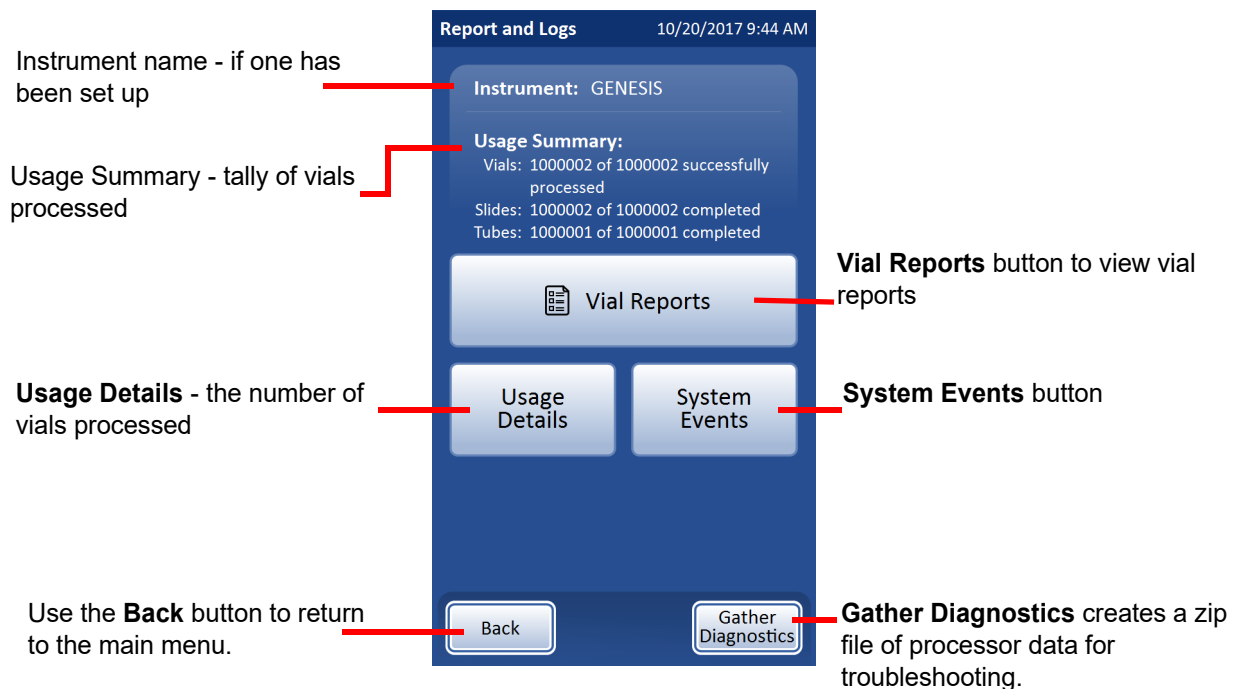

Figure 6-63 Reports and Logs screen

Vial reports

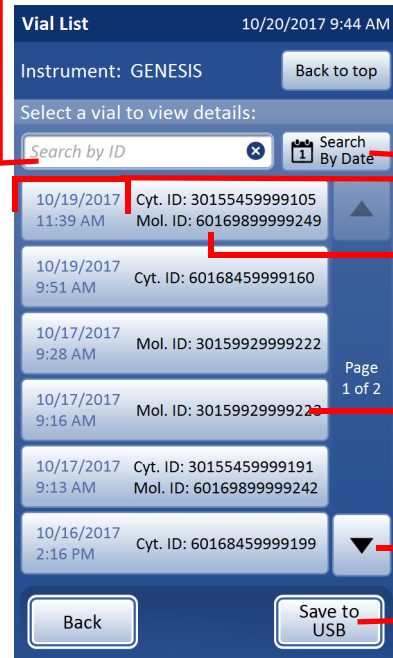

Figure 6-64 Vial Reports button

The system creates an individual vial report for each vial processed in the system.

The display will show a list of the reports generated for the last eight weeks, with the most recent at the top of the list. Each individual report is titled by a date and time stamp, generated at the moment the processing completed. Scroll up and down the list using the up- and down-triangle buttons. See Figure 6-65.

To search by ID, touch the field to type in the ID.



Instrument name

To search by date, touch the **Search by Date** button.

The list shows the date and time of processing and the vial ID(s) for the item(s) processed.

With the chain of custody feature disabled, there are no vial IDs in the report.

Touch a report to view it.

Use the **Back** button to return to the Reports screen.

Use the triangles to scroll through the list of system events.

Save to USB

Use **Back to top** button to return to the top of the list of system events.

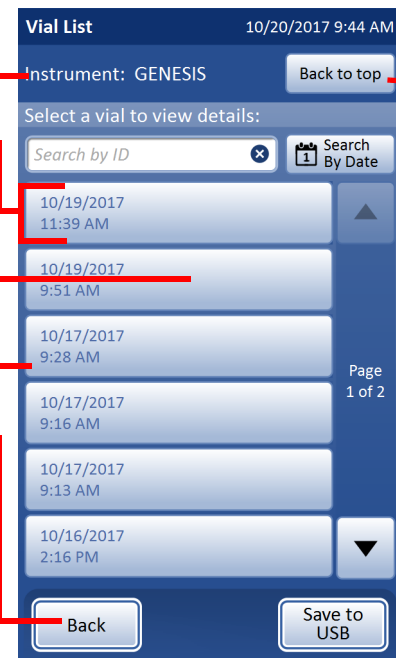

Example with Chain of Custody enabled

Example with Chain of Custody disabled

Figure 6-65 Vial reports list

Touch a report field to select it. The report is displayed on the user interface. See Figure 6-66.

There are two ways to search for a particular vial report.

To search by ID:



USER INTERFACE

1. Touch the empty field which says, “Search by ID” to display the keypad.
2. Enter the sample ID, cytology ID or molecular ID from the vial.
3. Press **Done** to close the keypad and start the search.
4. The vial report appears in the list. Touch the report in the list to open it. If the vial ID is not found, an orange message says that there are “no matches for” the vial ID.

To search by date the vial was processed:

1. Touch the **Search by Date** button.
2. Use the up- and down-triangles to enter the start date and the end date for the search. To limit the search for vials processed on a single day, use the same date for the start date and end date. Press **Search**.
3. All of vials that were processed in that range of dates appear in the list. Touch the report in the list to open it. If more than one vial meets the search criteria, the number of search results is displayed in green. If no vials were processed in the date range searched, an orange message says that there are “no matches for” the date range.

Touch an entry in the vial report list to see the vial report itself.

Vial Report

10/19/2017 Start: 11:39 AM
User ID: End: 11:44 AM

Cytology ID: 30155459999105

Slide ID: 30155459999105

Sequence: Gyn

Status: Completed ⚠
Warning 5006
Dilute sample

Molecular ID: 60169899999249

Tube ID: 60169899999249

Status: Completed ✓

Back to list

Annotations:

- Date that the vial was processed
- User ID, if the user was logged in when the process was run
- Time that the vial processing started and ended
- Sample Status:
 - Completed ✓ = slide made or aliquot removed
 - Completed ⚠ = The process completed, but an error was detected during the process.
 - Failed ✖ = An error stopped the process after the vial was uncapped.
- The Cytology section of the report shows:
 - the Sample/Cytology ID on the vial
 - the Slide ID
 - Sequence
 - Status
- The Molecular section of the report shows:
 - the Sample/Molecular ID on the vial
 - the Tube ID
 - Status
- Press the **Back to list** button return to the list of vial reports.
- Use the left and right triangles to scroll through the detailed view of the system events.

Figure 6-66 Vial report, example

Each vial report lists:

- The date and time that the vial was processed

- The user ID, if the user was logged in when the process was run
- The vial ID(s) read off of the vial label, if chain of custody was enabled when the process was run
- The slide ID read off of the slide label, if a slide was processed and if chain of custody was enabled when the process was run
- The tube ID read off of the tube label, if an aliquot was removed and if chain of custody was enabled when the process was run
- Any system events that may have occurred, with the event code and description
- Any vial events that may have occurred, with the event code and description
- A status of “Completed” or “Failed”

To close a report, press the **Back to list** button.

Note: The system will retain vial reports for eight weeks and then purge them from the database. Should your lab require longer record retention, plan to save the reports to USB. See “Usage details” on page 6.60.

Usage details



Figure 6-67 Usage Details button

Usage Details 10/20/2017 9:46 AM

Instrument name: Instrument: GENESIS

The Cytology section of the report shows:

- Sequence types
- Total number of vials processed to make a slide.

	Success	Failure	Total
Gyn	1000002	0	1000002
Non-Gyn	0	0	0
UroCyte	0	0	0
Total	1000002	0	1000002

The Molecular section of the report shows the total number of vials processed for aliquot removal.

	Success	Failure	Total
Total	1000001	0	1000001

Success = Aliquot successfully removed from a vial to a tube

Success = Samples successfully transferred from a vial to a slide

Failure = Samples where the process stopped after the vial was uncapped.

Save to USB

Use the **Back** button to return to the Reports screen.

Figure 6-68 Usage Details screen

The usage details report keeps a tally of the number of vials processed to date on the ThinPrep Genesis processor.

The usage history report identifies:

- The date and time of the report
- The instrument name (if one is used)
- The number of slides successfully processed, in the Cytology section of the report: Gyn (includes Imager slides), Non-Gyn and UroCyte.

Note: A sample vial that is uncapped increments the “Total” counter. A slide deposited into the fixative bath increments the “Success” counter.

- The number of aliquots successfully processed, in the Molecular section of the report.

Note: A sample vial that is uncapped increments the “Total” counter. Completion of the aliquot removal increments the “Success” counter.

System events

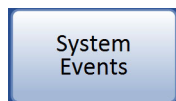

Figure 6-69 System Events button

The System Events report displays all of the error conditions encountered during sample processing, with the most recent at the top of the list. A system event is an error condition that the processor is not capable of recovering from without user intervention. Each individual report is titled by a date and time stamp, generated at the moment the error occurred. Scroll up and down the list using the up- and down-triangle buttons. Select a report by touching it. See Figure 6-70.

6

USER INTERFACE

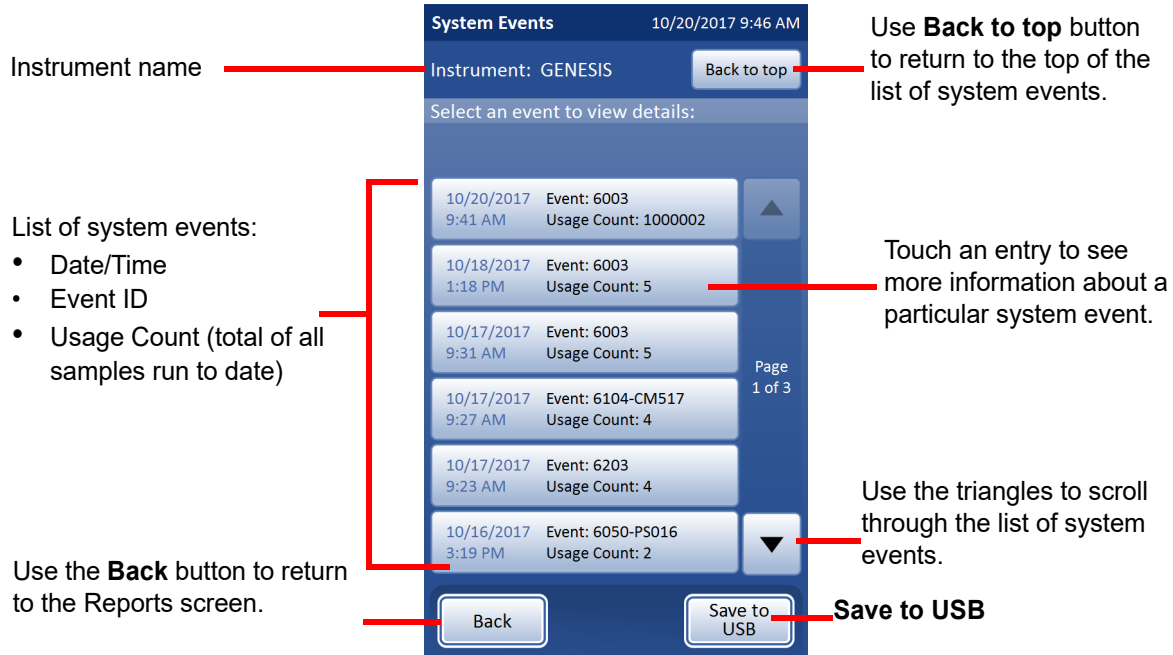

Figure 6-70 System Events screen

The list of system events includes the event code, the date and time of the error and the usage count - a tally of all samples processed on the instrument at the time of the event.

Select an event in the list to view details. Refer to Chapter 9, "Troubleshooting" for more information about system events.

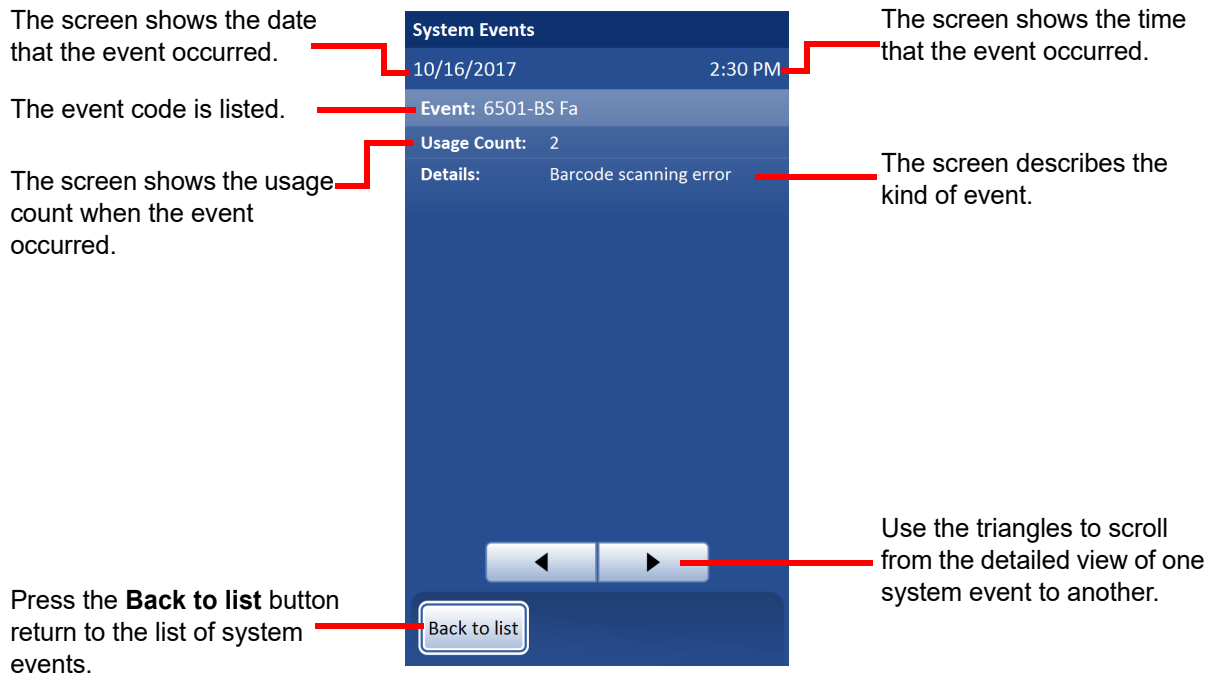

Figure 6-71 System Event details

Save a report to USB key

Reports can be saved to a USB key (also known as a thumb drive, flash drive, keychain drive). Insert a key into any of the USB ports.

Refer to Figure 1-6 and Figure 2-1 for USB port locations on the front and back of the processor.

The **Save to USB** button is on the System Events page.

Note: The system cannot write data to a write-protected USB key.

When the **Save to USB** button is pressed, the reports on the processor are immediately saved to the USB device as three XML files: system events, usage details, and vial reports. A confirmation message displays on the interface. See Figure 6-72.

Note: If the system detects that more than one USB port has a USB key inserted, a message via the user interface will prompt you to select which port to send the report to.

6

USER INTERFACE

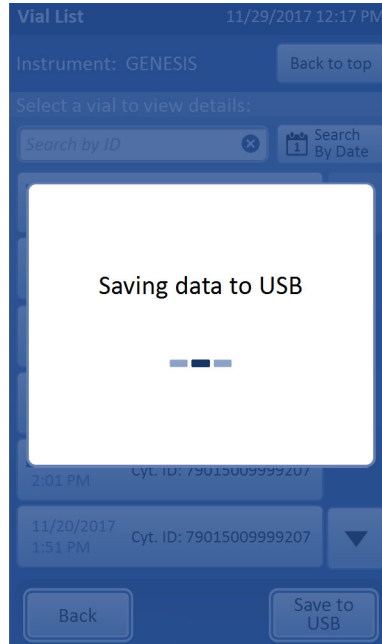

Figure 6-72 Saving data to USB

The system creates a folder titled GenesisReports on the USB device. Each report is written to there. Reports are automatically named by the convention of “Report type - Instrument Name - Date and Time. XML.” This is illustrated below. With each report type, a style sheet file is also created, so that when the report is viewed or printed from any other source, it will look like the report seen on the ThinPrep Genesis processor user interface.

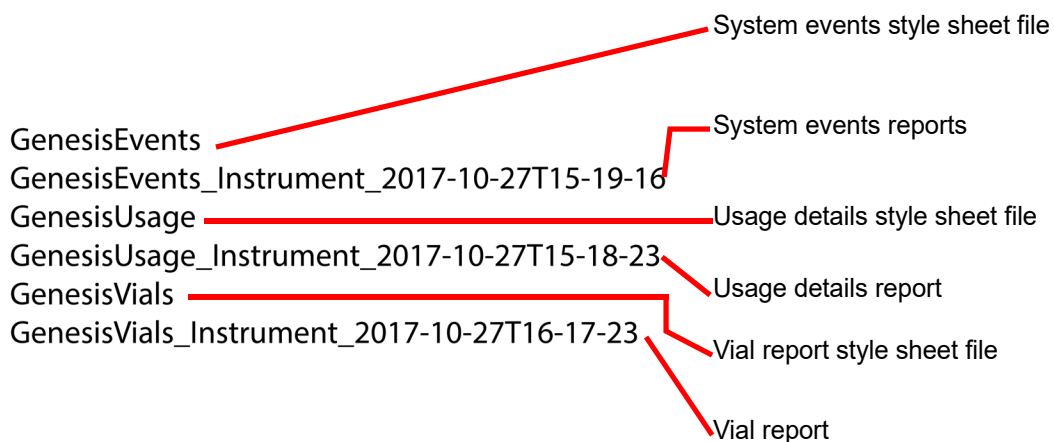

Figure 6-73 Reports saved to USB

Gather diagnostics



Figure 6-74 Gather Diagnostics button

Gather Diagnostics is a function intended for processor troubleshooting by Hologic Technical Support. It gathers and zips the error history log and other processor operating information. It is not accessible to operators.

Put a USB device into one of the USB ports and press the **Gather Diagnostics** button.

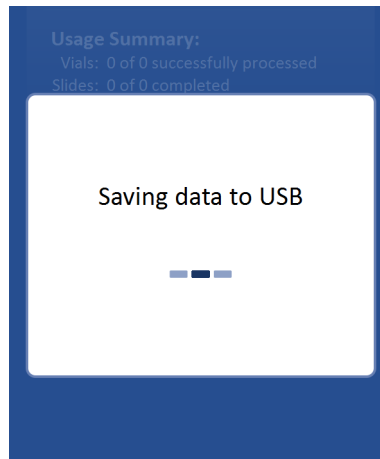

Figure 6-75 Gather Diagnostics screen

The processor operating information will be gathered into a folder on the USB device titled GenesisLogs. There will be three zipped files in the folder. These can be e-mailed to Hologic Technical Support.



USER INTERFACE

This page intentionally left blank.

Chapter Seven

Operating Instructions

SECTION A

INTRODUCTION

The ThinPrep Genesis processor can be used to process a sample onto a microscope slide, to pipette a 1-ml aliquot of the sample into a tube, and it can perform both processes on the same sample. Normal processor operation consists of selecting the item(s) for processing, loading supplies, starting the processing, and unloading the sample vial and the processing output. The output of process is a slide, a tube with an aliquot from the sample vial, or a slide and a tube with an aliquot from the sample vial. This section provides instructions for operating the ThinPrep Genesis processor for each of the different processes.

A vial report is generated after every vial is processed. The report indicates the success or failure of processing each vial, as well as any errors encountered. The report may be viewed on the user interface or the report may be saved as an xml file to a USB key.

This section provides instructions for operating the ThinPrep Genesis processor.

The following topics are covered in this section:

- SECTION B:** Optional Instructions for Ancillary Testing
- SECTION C:** Material Requirements
- SECTION D:** Label the Sample Vials, Slides, and Tubes
- SECTION E:** Open or Close the Door
- SECTION F:** Using the Tube Printer
- SECTION G:** Using the Slide Printer
- SECTION H:** Load the Fixative Bath
- SECTION I:** Load the Pipettes Tips
- SECTION J:** Pre-Operation Checklist
- SECTION K:** Select the Process and Begin Processing
- SECTION L:** Process a Slide on the ThinPrep Genesis Processor
- SECTION M:** Remove an Aliquot from the Sample on the ThinPrep Genesis Processor
- SECTION N:** Remove an Aliquot from the Sample and Process a Slide on the ThinPrep Genesis Processor
- SECTION O:** Cancel Sample Processing



OPERATING INSTRUCTIONS

SECTION B

OPTIONAL INSTRUCTIONS FOR ANCILLARY TESTING

Note: These optional instructions for ancillary testing describe aliquot removal without using the Aliquot or Aliquot + Slide features on the ThinPrep Genesis processor. To use the ThinPrep Genesis processor to remove a 1-ml aliquot from a ThinPrep sample vial, follow the instructions later in this chapter.

Testing for certain sexually transmitted infections (STI) and for Human Papilloma Virus (HPV) in conjunction with cytology may be performed from the ThinPrep sample vial. Refer to the instructions provided by the manufacturer of the assay for complete instructions for collection, transport, storage, preparation, and processing using the ThinPrep sample vial.

Laboratory personnel must follow the specific instructions in this section to appropriately remove the desired aliquot volume and prepare the PreservCyt sample vial for the ThinPrep Pap test. Adherence to this guidance must be maintained to ensure there is no adverse effect on the ThinPrep Pap test result.

Because cytology/HPV testing and STI testing address different clinical questions, aliquot removal may not be suitable for all clinical situations. Physicians and other persons responsible for ordering clinical tests should be familiar with the following:

- There is no evidence of degradation of cytology results by aliquot removal of up to 4 ml, however, this cannot be ruled out for all specimens. As with any subsampling step in anatomic pathology, chance misallocation of diagnostic cells may occur if they are very rare. If negative results from the specimen do not fit with the clinical impression, a new specimen may be necessary.
- Aliquot removal from low-cellularity specimens may leave insufficient material in the PreservCyt sample vial for preparation of a satisfactory ThinPrep Pap test slide.
- Aliquot Removal may leave insufficient material in the PreservCyt sample vial for performance of ancillary testing.
- Co-collection of separate samples for the ThinPrep Pap test and STI testing may be considered in lieu of aliquot removal.
- When opting for concurrent cytologic and STI testing, providers should consider risk and clinical history (e.g., disease prevalence, patient age, sexual history or pregnancy) as well as specimen suitability (e.g., exudates or bleeding) that can impact diagnostic reliability.

Sexually Transmitted Diseases Treatment Guidelines 2015 (Centers for Disease Control and Prevention, MMWR 2002: 51(No. RR-6)) provides clinical guidance for the management and treatment of individual patients, including use of Pap testing.

Manual Aliquot Removal—Pipetting an Aliquot (of up to 4 ml) from the PreservCyt Sample Vial Prior to Using the ThinPrep Genesis Processor

Note: Only one aliquot may be removed from the PreservCyt sample vial prior to processing the vial on the ThinPrep Genesis processor, regardless of the volume of the aliquot (maximum aliquot volume = 4 ml).

Note: Good laboratory practices should be followed to avoid introducing contaminants into either the PreservCyt sample vial or the aliquot. It is recommended to use powder-free gloves and an individually wrapped, disposable pipetting device with an aerosol barrier tip that is sized appropriately for the volume being withdrawn and dispensed. You should not use serological pipettes. In order to minimize the potential for cross contamination, aliquot removal should be performed in an appropriate location outside an area where amplification is performed.

1. Follow the instructions provided by the manufacturer of the other assay for complete instructions for collection, transport, storage, and preparation.
2. Using a pipetting device, withdraw an aliquot of up to 4 ml from the vial. Take care to avoid contaminating gloves with solution. If gloves should become contaminated, replace with a clean pair before proceeding to the next specimen.
3. Refer to the instructions provided by the manufacturer of the other assay for complete instructions for performing test(s) on the aliquot.
4. Dispose of the pipetting device in accordance with local, state, and federal regulations.
5. Using a new pipetting device, withdraw a quantity of unused PreservCyt Solution from its container that is equal in volume to that of the aliquot removed from the vial in step 3.
6. Transfer the volume of unused PreservCyt Solution to the vial from which the aliquot was removed in step 3.
7. Secure the vial cap. (The line on the cap and line on the vial should meet or slightly overlap.)
8. Dispose of the pipetting device in accordance with local, state, and federal regulations.
9. Refer to the remaining steps in this chapter to complete the ThinPrep Pap test.

7

OPERATING INSTRUCTIONS

SECTION C

MATERIAL REQUIREMENTS

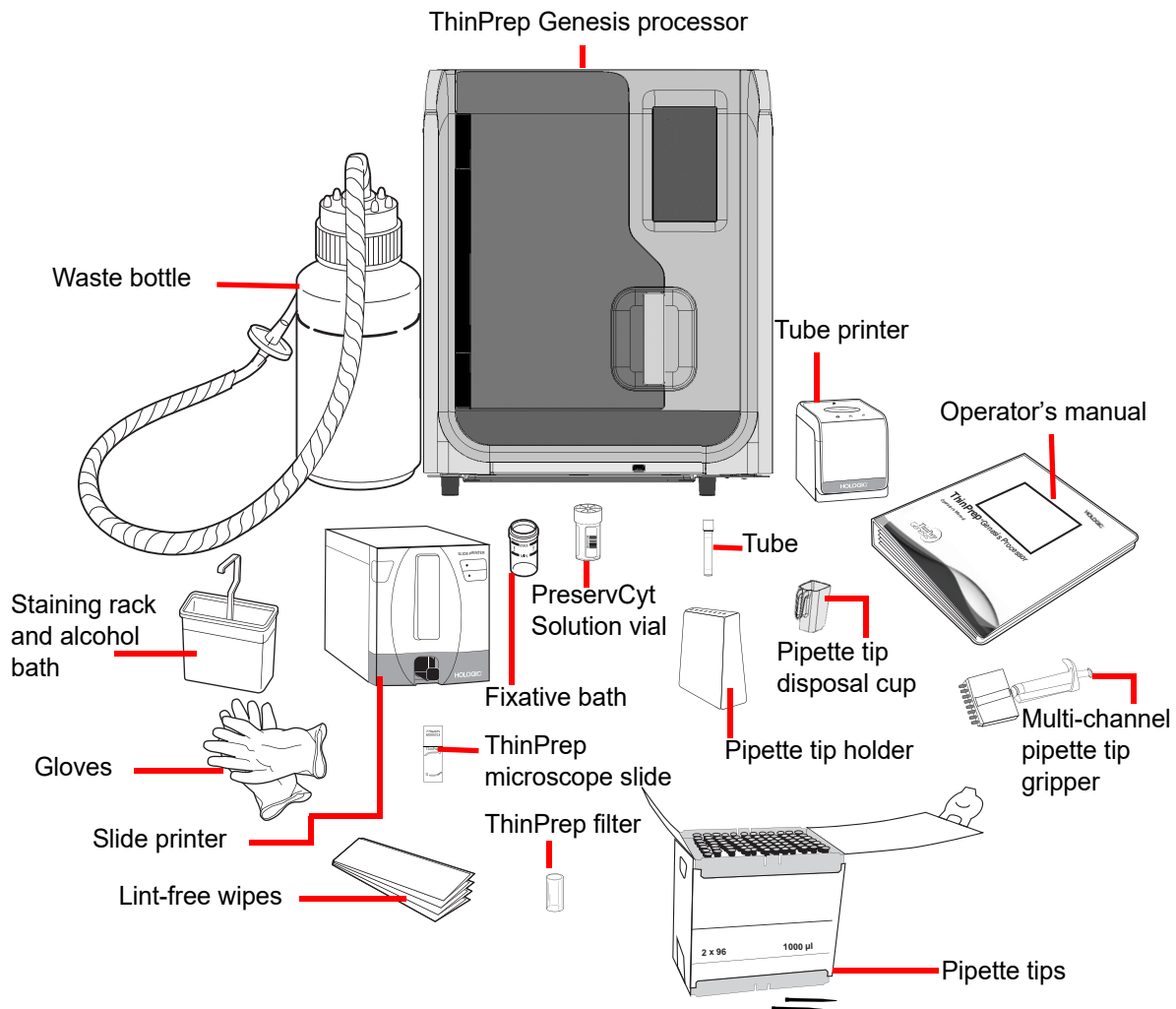

Figure 7-1 The required materials

The screen display on the ThinPrep Genesis processor guides the operator through the loading steps. The instructions differ depending on the items selected to process. Table 7.1 shows which materials are required for each process on the ThinPrep Genesis processor.

Table 7.1 Required materials for the different processes

Required Material	Cytology processing	Molecular processing	Cytology and molecular processing
ThinPrep® Genesis processor	✓	✓	✓
ThinPrep® PreservCyt Solution vial	✓	✓	✓
ThinPrep filter	✓		✓
ThinPrep microscope slide	✓		✓
Fixative bath	✓		✓
Slide printer	✓ (optional)		✓ (optional)
Pipette tip gripper		✓	✓
Pipette tips		✓	✓
Tube		✓	✓
Pipette tip holder		✓	✓
Pipette tip disposal cup		✓	✓
Tube printer		✓ (optional)	✓ (optional)
ThinPrep Genesis Processor Operator's Manual	✓	✓	✓



Table 7.1 Required materials for the different processes

Required Material	Cytology processing	Molecular processing	Cytology and molecular processing
Disposable laboratory gloves	✓	✓	✓
Lint-free wipes	✓	✓	✓
Alcohol bath with slide staining rack	✓		✓
Sodium hypochlorite solution (0.5% solution)		✓	✓

The ThinPrep® **PreservCyt Solution vial** (vial) is a plastic vial that contains a methanol-based preservative solution that preserves cells from all body sites. PreservCyt Solution is used for transportation, storage and processing of the cellular sample.

- Store PreservCyt Solution with gynecologic sample intended for ThinPrep Pap testing between 15°C (59°F) and 30°C (86°F) for up to 6 weeks
- Store PreservCyt Solution with non-gynecologic samples intended for cytology between 4°C (39°F) and 37°C (98°F) for up to 3 weeks.

Refer to Chapter 3 for detailed information on PreservCyt Solution.

The **ThinPrep filter** is a disposable plastic cylinder that is open at one end and has a filter membrane bonded onto the other end. The filter membrane has a flat, smooth, porous surface. The pore size differs, depending on the process application. There are three filter types for use on the ThinPrep Genesis processor:

- ThinPrep Pap test filters (clear)
- ThinPrep Non-gynecologic filters (blue)
- ThinPrep UroCyte filters (yellow)

The **ThinPrep microscope slide** is a high-quality, pre-cleaned, glass microscope slide with a defined screening area and a large labeling area. The slide is designed specifically for use with the ThinPrep Genesis processor. Depending on the process application there are three types of slides:

- ThinPrep microscope slides for use with ThinPrep processors are for gynecologic or non-gynecologic sample processing.

- ThinPrep Imaging System microscope slides for gynecologic slides that will be subsequently imaged on the ThinPrep Imaging System. (They bear pre-printed fiducial marks required for the Imaging System.)
- ThinPrep UroCytte microscope slides for use with the ThinPrep UroCytte urine sample processing. (The slides bear a particularly defined cell spot area for the processing of urine specimens.)

The **fixative bath** is a plastic vial that the operator fills with standard laboratory fixative alcohol. After the ThinPrep processor transfer cells onto the slide, it automatically deposits the slide into the fixative bath.

The **slide ID printer (optional)** is a custom printer designed to print slide IDs on ThinPrep microscope slides. The slide ID printer is specifically designed for use with the ThinPrep processor. Refer to the information provided with the slide ID printer for additional instructions.

The **tube** is a plastic tube with a diameter of 12.5 mm and a height with cap of approximately 91 mm. The threaded cap on the tube is specifically designed for use with the ThinPrep Genesis processor. Refer to the instructions provided by the tube manufacturer for more information.

The **tube printer (optional)** is a custom printer designed to print an ID label on the tube. The tube printer is specifically designed for use with the ThinPrep Genesis processor.

The **pipette tips** are conductive, disposable plastic pipette tips with an aerosol-resistant filter and a 1-ml aspiration capacity.

The **pipette tip disposal cup** is a plastic cup with a handle on one side and a magnet on the bottom. The pipette tip disposal cup is specifically designed for use with the ThinPrep Genesis processor.

Supplies used in the ThinPrep Genesis processor are those designed and supplied by Hologic specifically for the ThinPrep Genesis processor. These include PreservCyt Solution vials, ThinPrep filters, and ThinPrep microscope slides. These supplies are required for proper performance of the system and cannot be substituted. Product performance will be compromised if other supplies are used. After use, supplies should be disposed of in accordance with local, state, and federal regulations.

The **ThinPrep Genesis Processor Operator's Manual** contains detailed information about the ThinPrep Genesis processor, such as the principles of operation, operating instructions, specifications, and maintenance information. The manual also contains information on the solutions and materials required to prepare slides and to transfer a 1-ml aliquot with the ThinPrep Genesis processor.

The **Pipette tip gripper** is a hand-held, 8-channel, manual pipette tip gripper. The pipette tip gripper is used with the ThinPrep Genesis processor to transfer 1-ml pipette tips from their packaging to the processor.

Disposable laboratory gloves — non-powdered gloves are recommended.

Lint-free wipes.



OPERATING INSTRUCTIONS

Alcohol bath with slide staining rack and standard laboratory fixative alcohol are required to process a sample onto a microscope slide.

0.5% sodium hypochlorite solution is required for preparing work surfaces before using the instrument's aliquot feature.

SECTION D

LABEL THE SAMPLE VIALS, SLIDES AND TUBES

When the chain of custody setting is enabled on the ThinPrep Genesis processor, the vial label ID(s), the tube label ID, and the slide label ID are entered to the ThinPrep Genesis processor, by scanning the label or by manual entry. The scanner on the ThinPrep Genesis processor can read certain barcode or OCR formatted labels. (See "Configure Barcodes" on page 6.38 for setting which format the scanner reads.)

When the chain of custody setting is set to "off" on the ThinPrep Genesis processor, it is important to properly adhere a vial label, a slide label, or a tube label, but the information on the label is not used by the processor.

Vial Label Barcode Format

The sample vial barcode label must meet ANSI X3.182 specifications with a quality of grade B or better. Hologic recommends Code 128, 1-D barcode symbology for the barcode label on the sample vial.

The ThinPrep Genesis processor supports the following types of 1-D barcodes on vial labels: Code 39, Code 93, Code 128, Interleaved 2 of 5, Codabar, and EAN/JAN-13.

The ThinPrep Genesis processor supports the following types of 2-D barcodes on vial labels: DataMatrix and QR Code. There are two, 16-digit numbering schemes that the ThinPrep Genesis processor will not recognize as a vial ID for 2-D barcodes. If your laboratory uses a 2-D DataMatrix barcode type and a 16-digit vial ID format for vial IDs, do not use a vial ID in the format 10XXXXXX17XXXXXX, nor the format 01154200455XXXXX.

No OCR vial label formats may be used.

Refer to Table 6.1, "Slide label restrictions based on barcode symbology used," on page 30 for detailed description of constraints placed on the ID depending on the slide ID format used. Refer to Table 6.2, "Tube label restrictions based on barcode symbology used," on page 37 for detailed description of constraints placed on the ID depending on the tube ID format used.

Adhering Vial Labels

Place the vial barcode label **vertically** on the PreservCyt® Solution label, using the edge for alignment, as shown in Figure 7-2. A crooked label, skewed 10 degrees or more from vertical, may

not scan properly. During application, avoid placing the barcode label over patient information, multiple labels, or on the torque features of the vial. Do not place labels on the vial cap or on the bottom of the vial. Sticking labels on incorrectly can cause a failure to read the barcode or a failure of the processor removing and replace the vial cap.

The uncovered strip of the sample vial allows you to see the frosted band which indicates the maximum/minimum acceptable fluid fill range for a sample to be run on the processor. Make sure the fluid level is within this range.

Additionally, check to make sure there is no foreign matter in the vial (such as a piece of sample collection device or other non-biologic debris).

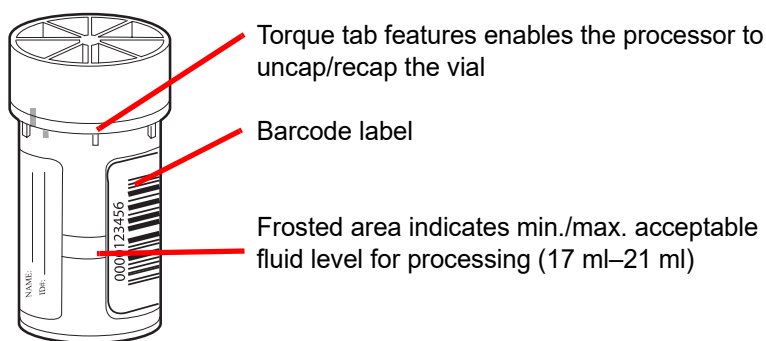

Figure 7-2 PreservCyt Solution sample vial

Slide Printer for the ThinPrep Genesis System

The ThinPrep Genesis System includes the ThinPrep Genesis processor and the optional slide printer. This system can be configured to print a custom label on the slide, based on the sample ID or cytology ID on the vial label. Configuration of the system for label printing should be completed as part of the initial processor setup, before processing samples. See “Slide Labels” on page 6.26 and “Configure the slide ID” on page 6.52, for more information.

Tube Printer for the ThinPrep Genesis System

The ThinPrep Genesis System includes the ThinPrep Genesis processor and the optional tube printer. This system can be configured to print a custom label on the tube, based on the sample ID or molecular ID on the vial label. Configuration of the system for label printing should be completed as part of the initial processor setup, before processing samples. See “Tube Labels” on page 6.36 and “Configure the tube ID” on page 6.54, for more information.

Manually Applied Slide Labels and Tube Labels

Without the slide printer or tube printer available from Hologic, slide labels and tube labels can be printed and applied by hand.

Slide labels that are applied to the microscope slide must be compatible with staining and coverslipping processes and be xylene-resistant. When adhering the labels, be sure to apply them

smoothly to the frosted area of the slide, with no overhang or air bubbles. Labels should be centered side to side. The OCR or barcode IDs must be in an area that the scanner is able to read, as seen in Figure 7-5.

Slide labeling requirements

When the chain of custody setting is enabled on the ThinPrep Genesis processor, a slide must bear a label with an accession ID that is related to the sample ID or cytology ID on the vial. Refer to “What the slide ID or tube ID looks like” on page 6.44, for more information.

Slide barcode label format

Slide barcode labels may be 1- or 2-dimensional. See Table 6.1 on page 30 for restrictions. Slide labels may be printed and applied or directly printed or etched onto the slide, but make sure the contrast is sufficient for the scanner to read the label.



Figure 7-3 Examples of how barcodes fit onto a ThinPrep slide

Slide OCR label format

OCR label format must be 14 characters long (which reserves the last 3 characters as check characters). See Figure 7-5.



Figure 7-4 Example of OCR labels on a ThinPrep slide

Required slide label format for use with the ThinPrep® Imaging System Imaging Station

For ThinPrep Pap test slides that will subsequently be imaged by the ThinPrep Imaging System Imaging Station, slide labels must be in an OCR, 14-character, 7 digits-over-7 digits format, with the last 3 digits being a CRC number. The font must be 12 point OCR-A. Numbers only, no alpha characters.

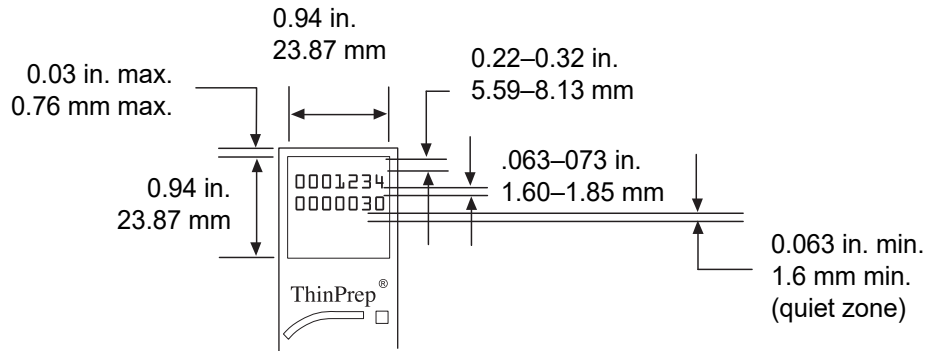

Figure 7-5 Slide OCR label formats

Tube labeling requirements

When the chain of custody setting is enabled on the ThinPrep Genesis processor, the tube must bear a label with an accession ID that is related to the sample ID or molecular ID on the vial. The tube label must be one of the 1-D barcode symbologies supported (Code 128, Interleaved 2 of 5, Code 39, Code 93, EAN/JAN 13, or Codabar). Refer to “What the slide ID or tube ID looks like” on page 6.44, for more information.

The top of the label on the tube must be 56–73 mm from the bottom of the tube, and the bottom of the label on the tube must be 10–40 mm from the bottom of the tube.

If the aliquot in the tube will be used for further testing, consult the instructions provided by the manufacturer of that assay for additional tube label information.

SECTION E

OPEN OR CLOSE THE DOOR

To open the door, grasp the handle and pull the door open.

To close the door, grasp the handle and push the door shut.

The processor will not operate if the door is open. The door must never be opened during processor operation. If the door is opened after processing begins, the sequence will abort and an error message appears on the screen display. The system will wait until the door is closed before system recovery will occur.

7

OPERATING INSTRUCTIONS

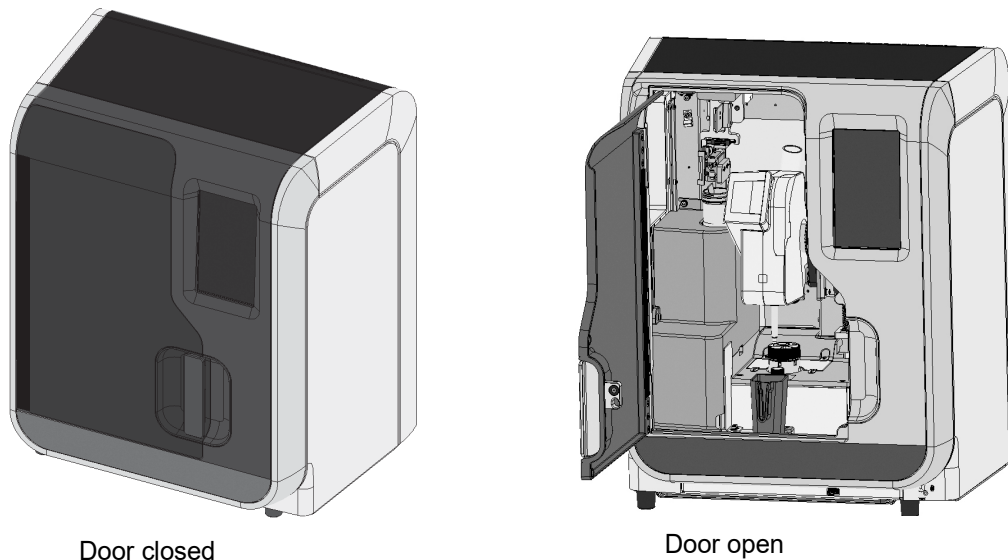

Figure 7-6 Door opening and closing

Caution: Do not open the door during processing. Depending on where a sequence is interrupted, cells may be lost or air-dried during recovery.

Caution: Do not put the door or the touch screen on the processor in contact with strong solvents such as xylene, which may damage the surface of the door or the touch screen.

**SECTION
F****USING THE TUBE PRINTER**

The tube printer is an optional component in the ThinPrep Genesis System, and is installed by Hologic Field Service.

- A bright green light ring around the tube cavity indicates that the tube printer is ready to use, in an idle state, connected to power, and connected to the ThinPrep Genesis processor.
- A pale green light ring around the tube cavity indicates that the tube printer has power, but the tube printer is not properly connected to the ThinPrep Genesis processor.
- A blue light ring around the tube cavity indicates that loading and printing are in progress.
- A red light ring around the tube cavity indicates that an error with the tube printer has occurred.

Before the tube printer can be used to print IDs on tube labels, the criteria for the tube label needs to be set up in the ThinPrep Genesis processor. Refer to “Tube Labels” on page 6.36. The tube printer is only used for processes that include aliquot removal and only when the chain of custody is enabled on the ThinPrep Genesis processor.

1. When prompted by the screen display on the ThinPrep Genesis processor, gently place an unused specimen transfer tube straight into the tube cavity of the tube printer. The tube is properly seated when the foil top of the tube is flush with the top surface of the tube printer. Do not touch the foil top of the tube. Ensure that gloves do not touch the foil top. Follow all instructions provided by the tube manufacturer for the safe handling of the tube.
Note: If any liquid contamination of gloves is suspected, discard gloves and replace with a new pair in order to avoid the risk of aliquot or vial contamination.
If any contamination of the cap is suspected, consult the instructions provided by the tube manufacturer.
2. The light ring around the tube cavity turns blue until the tube printer finishes printing the ID on the tube.
3. The light ring around the tube cavity returns to bright green when the printing is complete. Remove the tube from the tube printer.

If an error occurs, for example, if the tube has already been printed with an ID, the light around the tube cavity turns red. Follow the instructions on the ThinPrep Genesis processor touch screen to resolve the error.

7

OPERATING INSTRUCTIONS

Insert the tube straight up and down into the tube cavity.

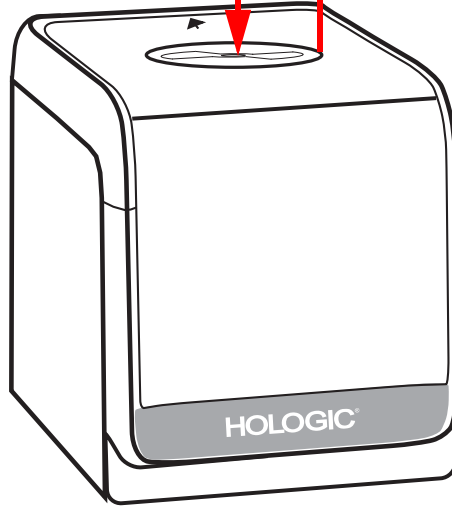

The color of the light in the ring around the tube cavity indicates the status of the tube printer.

Figure 7-7 Tube printer

Caution: Do not use the tube printer to print anything other than the thermal transfer label on specimen transfer tubes.

**SECTION
G****USING THE SLIDE PRINTER**

The slide printer is an optional component in the ThinPrep Genesis System, and is installed by Hologic Field Service.

- A blue light on the power button and in the slide cartridge indicates that the slide printer is: ready to use, in an idle state, has slides in the slide cartridge, has a properly installed slide printer ribbon, is connected to power, and is connected to the ThinPrep Genesis processor.
- A blinking blue light in the slide cartridge indicates that there are no more slides in the cartridge or there is an error feeding the slide from the slide cartridge.
- A blue light on the eject slide button indicates that there is an error such that a slide needs to be ejected. Press the eject slide button to eject a slide.

Before the slide printer can be used to print on a slide label, the criteria for the slide label needs to be set up in the ThinPrep Genesis processor. Refer to “Slide Labels” on page 6.26. The slide printer is only used for processes that include a slide and only when the chain of custody is enabled on the ThinPrep Genesis processor.

WARNING: Glass

The instrument uses microscope slides, which have sharp edges. In addition, the slides may be broken in their storage packaging or on the instrument. Use caution when handling glass slides and cleaning the instrument.

Load Slides into the Slide Cartridge

1. Remove the slide cartridge from the slide printer by grasping the cartridge, pushing up and then pulling out.
2. Turn the slide cartridge so that the lid is facing up. Press the indentation near the lid to unlatch the lid. Open the lid.
3. Open a 100-pack of slides. Orient the 100-pack of slides so that the slide label area is on the right.

Notes: Load the slide cartridge with the type of slide that corresponds to the sample type that is processed.

The slide cartridge can hold approximately 100 slides, and for best results fill it between half-way and one-third full.

4. Transfer and separate slides.
 - A. With gloved hands, carefully grasp a group of slides from the package. Pinch the group of slides in the slide label area. Use your other hand to support the group of slides. Do not touch the cell spot area of the slide. To separate slides that may be held by static, consider spreading the group of slides like a fan.

7

OPERATING INSTRUCTIONS

- B. Gently place the group of slides into the slide cartridge.
- The label end of the slide lines up with the arrows on the interior of the slide cartridge.
 - The arrows on the interior of the slide cartridge point from the bottom, unlabeled side of the slides, to the top, labeled side of the slides.
 - Fill the slide cartridge between half-way and one-third full.
- C. Verify the position of the slides in the slide cartridge. Always wear gloves when handling the slides.
- If any slide is askew in the cartridge, with a gloved hand, move the slides to line up in the cartridge.
 - Lightly drag a gloved finger over the slides in the cartridge to separate slides that may be stuck to each other. Slides that are stuck together can prevent the slide printer from properly advancing a slide from the slide cartridge.
5. Close the lid of the slide cartridge.

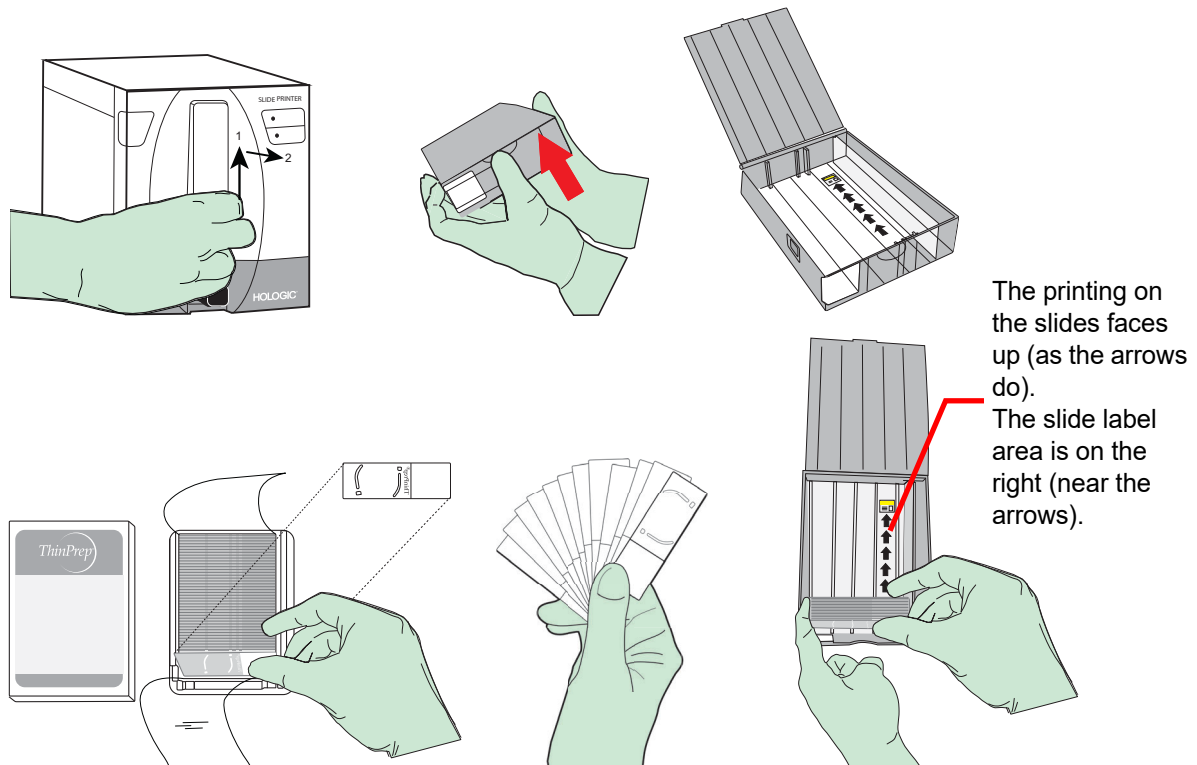

Figure 7-8 Load ThinPrep microscope slides into the slide printer

Load the Slide Cartridge into the Slide Printer

With slides loaded into the slide cartridge and with the lid closed on the slide cartridge, push the slide cartridge into the slide printer. The opening in the wall of the slide cartridge faces the interior of



the printer. The arrows on the interior of the slide cartridge point up. You will feel and hear a click when the slide cartridge is properly seated. The blue light illuminates the slide cartridge when the slide cartridge is properly seated.

Printing a Slide Label

When the ThinPrep Genesis System is set up to print slide labels with the slide printer, a slide is automatically printed. Remove the printed slide from the slide printer slide bin and load it in the ThinPrep Genesis processor when prompted by the display on the touch screen.

7

OPERATING INSTRUCTIONS

SECTION H

LOAD THE FIXATIVE BATH

1. The processes on the ThinPrep Genesis processor that transfer sample cells to a ThinPrep microscope slide require a fixative bath. Fill a fixative bath with standard laboratory fixative alcohol until the fluid level is between the “MIN” and “MAX” marks on the vial.

If the staining protocol requires alternative fixation methods, leave the fixative bath empty or fill it with the appropriate fixative solution.

Change the contents of the fixative bath at least every 100 slides or daily, whichever occurs first.

2. Before running a process that transfers sample cells onto a ThinPrep microscope slide, place the fixative bath into the fixative bath holder. The bottom of the bath rests on the base of the holder. Refer to Figure 7-9.

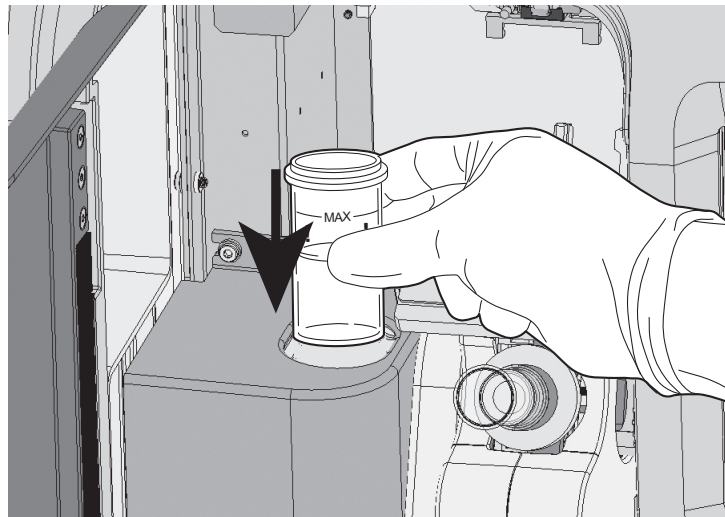

Figure 7-9 Loading the fixative bath

SECTION

I

LOAD THE PIPETTE TIPS

The processes on the ThinPrep Genesis processor that pipette an aliquot from the sample vial require pipette tips. The pipette tip holder in the ThinPrep Genesis processor holds up to eight, 1-ml pipette tips at a time. During processing, the pipette tip holder on the ThinPrep Genesis processor is stored under a cover. The processor keeps track of the number of pipette tips on-board, and the screen display indicates when the processor is running out of pipette tips. A pipette tip must be used only once and cannot be re-used.

Caution: Do not touch the pipette tips, even with gloved hands. Use the gripper to move pipette tips from their packaging to the pipette tip holder on the ThinPrep Genesis processor.

Caution: Store pipette tips in a way that keeps them clean, covered and in their packaging, following any storage and handling instructions provided by the manufacturer.

1. To load the pipette tips, from the main menu of the ThinPrep Genesis processor display, select **Admin Options**.
2. Then, select **System Maintenance**. From the System Maintenance screen, select **Load Pipette Tips**.

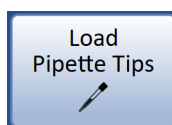

Figure 7-10 Load pipette tips button

7

OPERATING INSTRUCTIONS

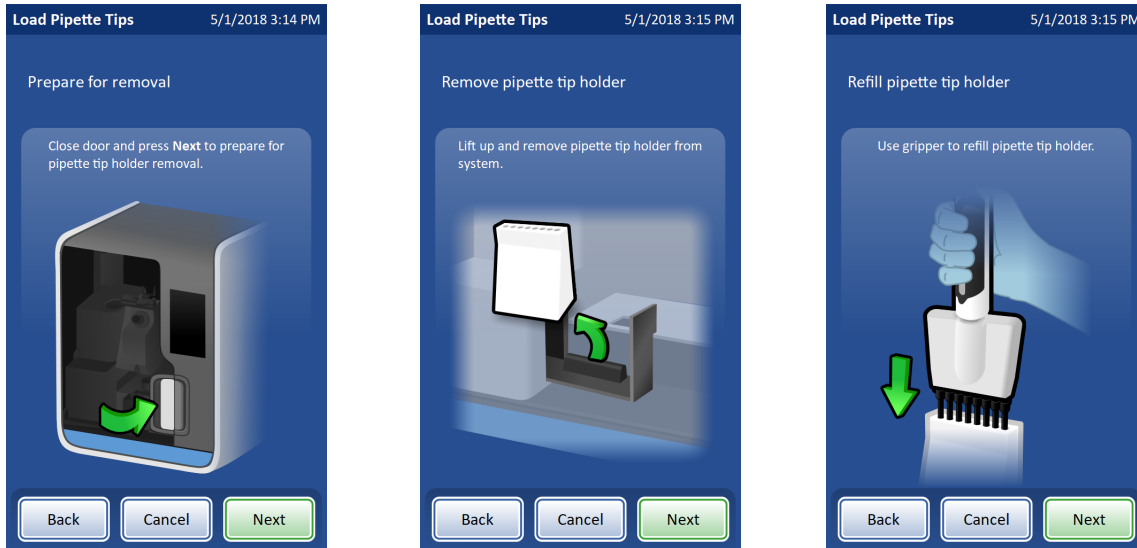

Figure 7-11 Load pipette tips into the pipette tip holder

3. Close the door and press **Next** to prepare for pipette tip holder removal. The processor slides the pipette tip holder to the center of the processor for removal and loading.
4. Open the door.
5. Pull the pipette tip holder straight up and remove it. Press **Next**.
6. Use a pipette tip gripper to move the pipette tips from their packaging into the slots in the pipette tip holder. Press **Next**.
7. Place the pipette tip holder back into system.

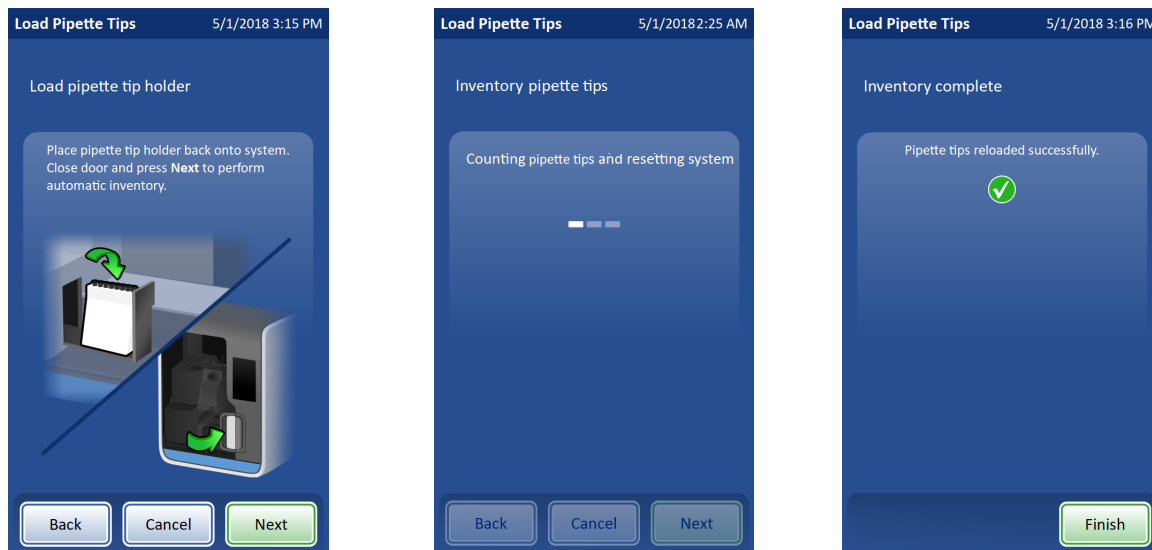

Figure 7-12 Return loaded pipette tip holder

8. Close the door and press **Next**. The processor will count pipettes, reset the system, and return the pipette tip holder to its covered storage area. An "inventory complete" message will be displayed.
9. Press **Finish** to return to the main menu.

SECTION

J

PRE-OPERATION CHECKLIST

The following conditions should be checked before preparing a slide or removing an aliquot on the ThinPrep Genesis processor.

- Waste bottle — Make sure the fluid level of the waste bottle is below the "MAX" fill line of the bottle. Refer to "Empty the Waste Bottle" on page 8.13, for emptying instructions.
- Main menu — Confirm that the processor is powered on and the screen displays the main menu. The processor is in idle mode when the main menu displays. If the main menu is not displayed, follow the instructions on the display until the main menu appears. If the system's power is off, refer to "Turn on the ThinPrep Genesis System" on page 2.6 for turning system power on.
- Required materials— Have the required materials handy and properly labeled. When the chain of custody setting is enabled on the ThinPrep Genesis processor, there is a 5-second time period between scanning labels and loading supplies.
- Disposable laboratory gloves — Always wear disposable laboratory gloves and other lab safety garments when operating the ThinPrep processor.

Note: Once sample has been added to a PreservCyt *Solution* vial, the vial is then designated as a *PreservCyt sample vial*.

SECTION

K

SELECT THE PROCESS AND BEGIN PROCESSING

The ThinPrep Genesis processor offers three processes:

Slide: The ThinPrep Genesis processor transfers cells from a sample onto a microscope slide

Aliquot: The ThinPrep Genesis processor pipettes a 1-ml aliquot of a sample into a tube

Aliquot + Slide: The ThinPrep Genesis processor performs both the aliquot removal and the slide process from the same sample.

7

OPERATING INSTRUCTIONS

Choose the items to process.
("Slide" is selected here.)

When the process includes making a slide, the "Sample type" buttons will be available. Select the type of sample that will be used to on the slide.

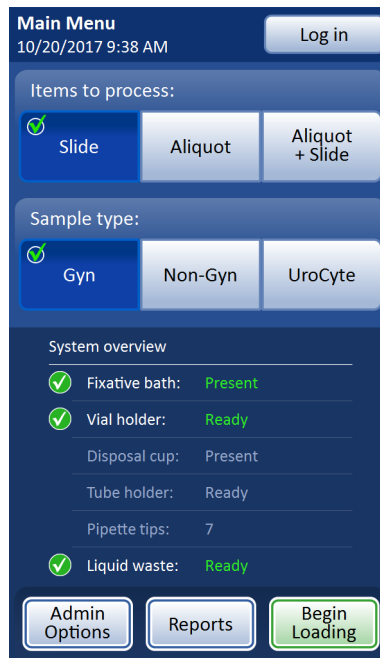

The "System overview" area shows which materials are required. The "Slide" process is selected in this example.

Press the **Begin Loading** to begin loading the supplies.

Figure 7-13 Main Menu: select the process and sample type





1. From the main menu, select the items to process: **Slide**, **Aliquot**, or **Aliquot + Slide**.
2. When the process includes making a slide, the "Sample type" buttons will be available. Select the type of sample that will be used to make the slide.

Caution: For best slide preparation results, use the correct slide, filter and vial type for the sample type that is processed.

Caution: The ThinPrep Genesis processor retains these selections for use on subsequent samples. To change to a different process or different sample type when the main menu is not displayed, return to the main menu by pressing the **Back** or **Cancel** button before loading supplies.

Note: When the ThinPrep Genesis processor is in an idle state, the instrument will pause periodically to check the system. The pause can be as frequent as once every twenty minutes for several seconds.

Table 7.2 Sample/Filter/Slide Configurations

	ThinPrep		ThinPrep + Imaging	UroCyt
PreservCyt sample	Gynecologic	Non-gynecologic	Gynecologic	Urine for cytology processing or with slide-based molecular testing such as the UroVysion assay
Filter	Clear	Blue	Clear	Yellow
Slide	Cell spot arc	Cell spot arc or arc-less	Cell spot arc with fiducial marks	Cell spot circle
				

The required materials differ based on the item to be processed. The “System overview” area on the screen display shows which materials are required to run the selected process.

SECTION
L

PROCESS A SLIDE ON THE THINPREP GENESIS PROCESSOR

Load the Processor

The following supplies must be loaded into the processor for the “Slide” process, which transfers cells to a microscope slide:

- PreservCyt sample vial
- ThinPrep filter
- ThinPrep microscope slide
- Fixative bath (Refer to “Load the Fixative Bath” on page 7.18 for details.)

7

OPERATING INSTRUCTIONS

1. Open the ThinPrep Genesis processor door.
2. Enter the vial ID:

Scan the barcode on the vial label. Hold the vial approximately 3 to 5 inches (7 to 12 cm) from the barcode scanner, with the barcode label parallel to the scanner. See Figure 7-14.

Or, manually enter the vial ID on the vial label using the keypad and press **Done**.

Note: If chain of custody is disabled on the processor, the vial ID is not used by the processor.

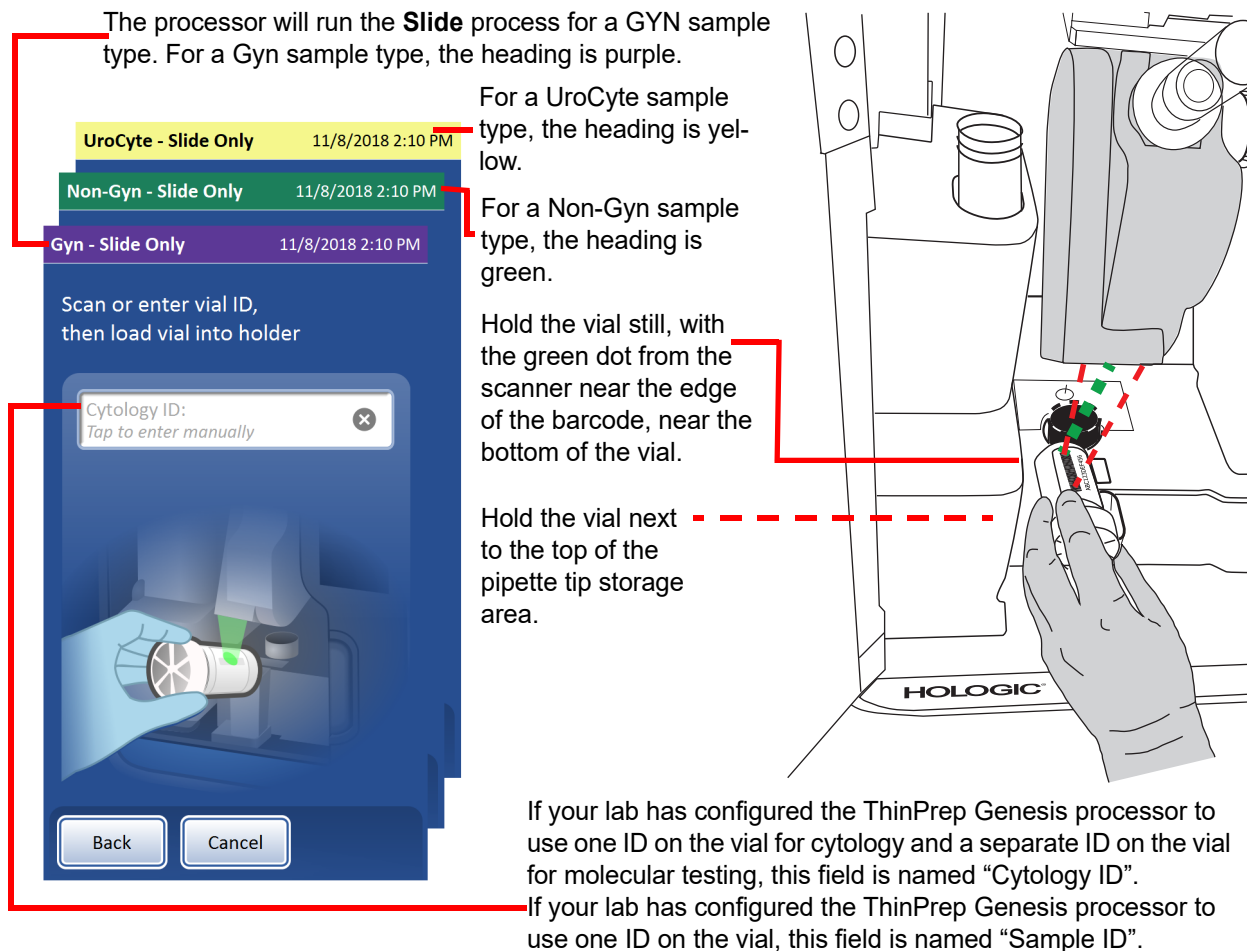

Figure 7-14 Enter the vial ID, barcode scanner shown

3. Gently place the labeled, tightly capped PreservCyt vial containing the patient sample into the disperser cup until the bottom of the vial rests on the disperser cup base. Refer to Figure 7-15.

Note: If chain of custody is enabled on the processor, the vial must be placed in the holder within five seconds of entering the vial ID. If the five-second countdown expires before the vial is in the holder, follow the prompts on the screen display to scan the vial ID again.

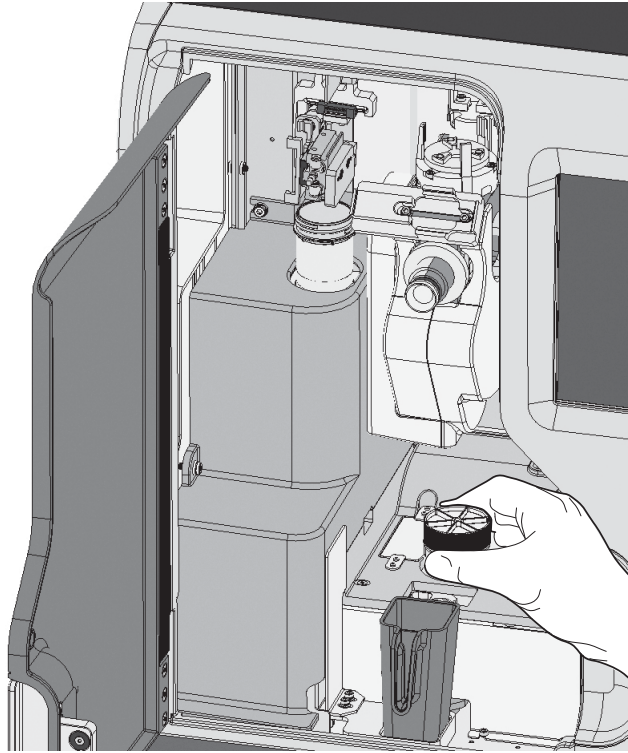

Figure 7-15 Load vial

The vial will remain loose in the dispenser cup until the process begins. The processor will automatically grasp and uncap the vial during processing.

7

OPERATING INSTRUCTIONS

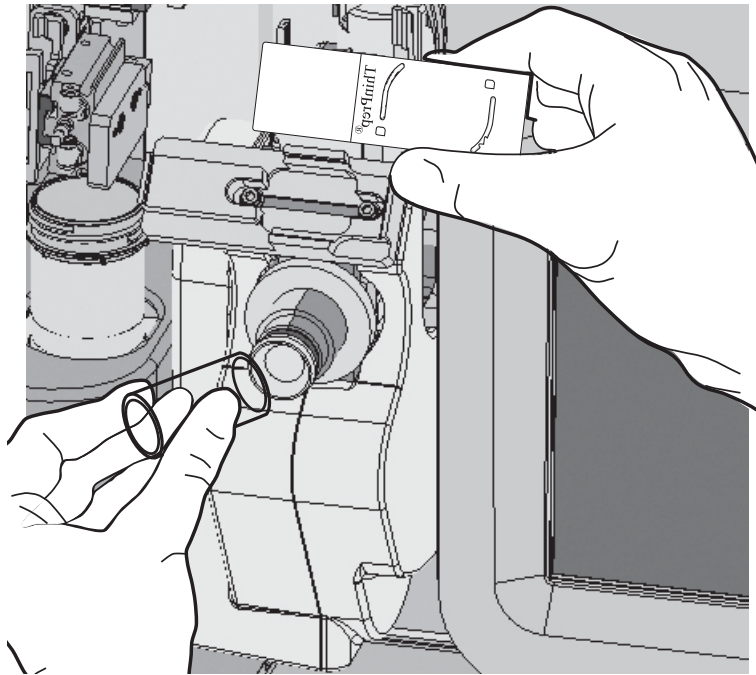
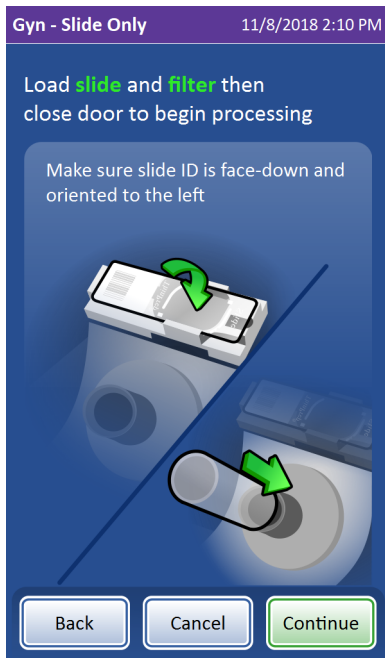

Figure 7-16 Load slide and filter

4. If the system includes the optional slide printer, the slide printer automatically prints the slide. Refer to "Slide Labels" on page 6.26 and "Configure the slide ID" on page 6.52 for set-up information.
5. Load a labeled microscope slide into the slide nest.
It is important to load the slide facing in the proper direction so that the cell spot will end up in the correct position on the slide. Orient the slide so that the frosted, label end of the slide is on the left and facing down. Be sure not to touch the slide within the defined screening area. Place the slide so that the slide lays flat in the slide nest.

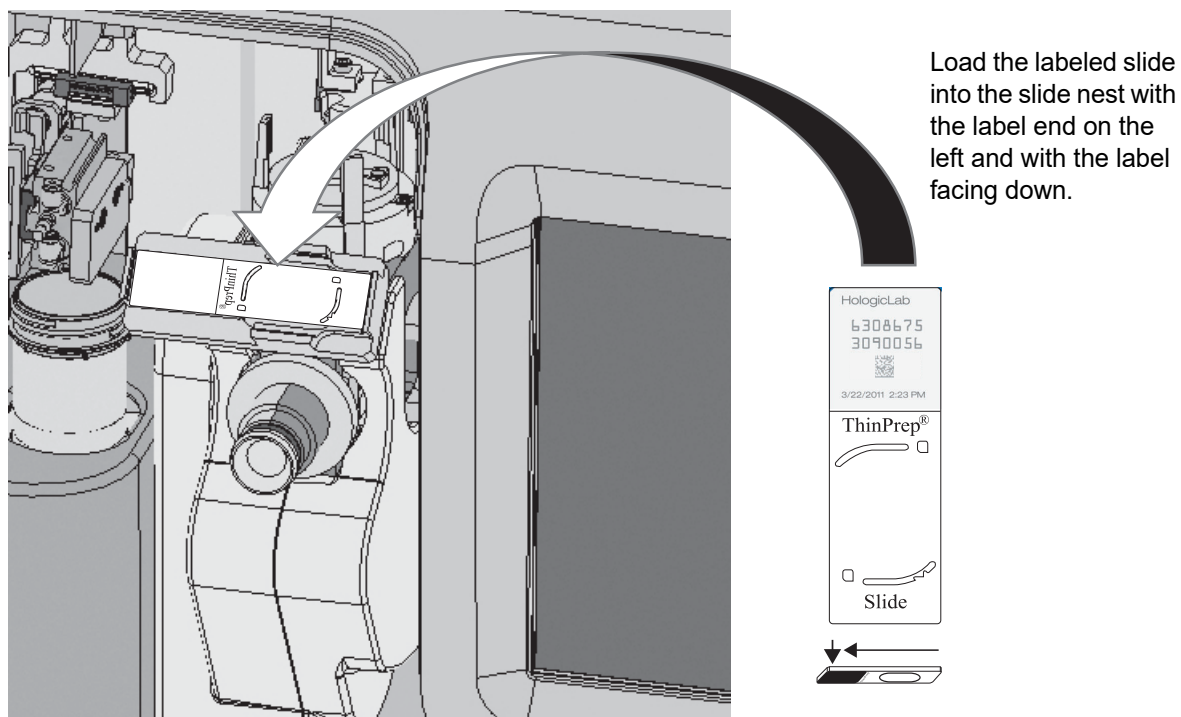

Figure 7-17 Load slide with the label end to the left and facing down

6. Remove a new ThinPrep filter from the storage tray by grasping the sides of the cylinder.
7. Push the open end of the filter onto the filter plug.

Caution: Never touch the filter membrane of the ThinPrep filter.

Caution: For best slide preparation results, use the correct slide type and filter type for the sample type that is processed.

8. Close the door.
9. Press the **Continue** button.

Note: If "Auto-start with Door Close" is enabled, the process starts when the door is closed, and the **Continue** button is not available.

7

OPERATING INSTRUCTIONS

Processing: Slide

This section describes the sequence of events in the “Slide” process on the ThinPrep Genesis processor.

Table 7.3 Sequence of Events in Processing a Slide

	<p>Continue button is pressed.</p>
	<p>Check for the presence of a new filter. Pick the slide from the slide nest. Rotate slide to horizontal position and place on cell transfer station. Rotate the filter to check that the filter is seated correctly on the filter plug.</p>
	<p>Scan the slide ID. Check the slide ID. Note: This step does not happen if chain of custody is disabled on the processor settings.</p>

Table 7.3 Sequence of Events in Processing a Slide

	<p>Move the slide to the side. (The slide is now vertical.)</p>
	<p>Grasp the vial and tighten the vial cap.</p>
	<p>Spin the vial to disperse the contents.</p>

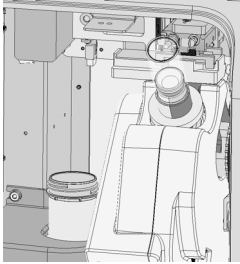
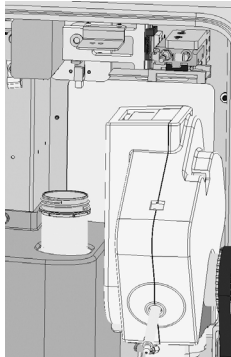

OPERATING INSTRUCTIONS

Table 7.3 Sequence of Events in Processing a Slide



	<p>Uncap the vial.</p> <p>Introduce filter to vial and perform level sensing to verify min./max. liquid level.</p> <p>Cell collection onto filter</p>
	<p>Cell transfer onto slide</p>
	<p>Deposit slide into fixative bath.</p>

Table 7.3 Sequence of Events in Processing a Slide

	Puncture filter.
	Recap vial.
	Processing is complete. Unlock the door.

Remove Slide, Sample and Filter

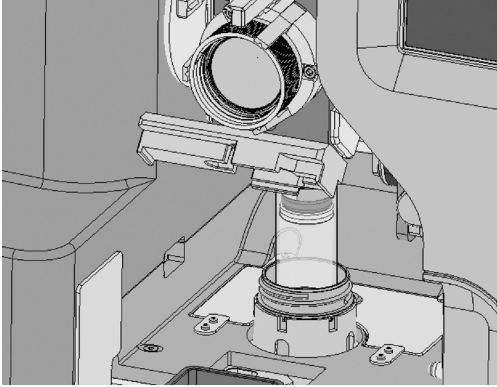
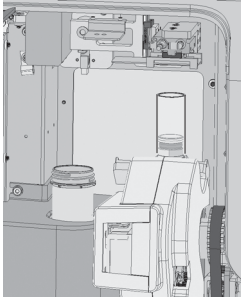
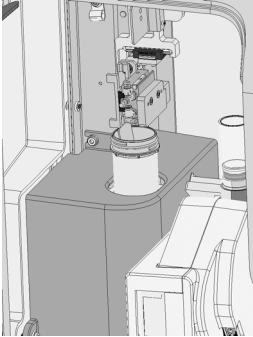
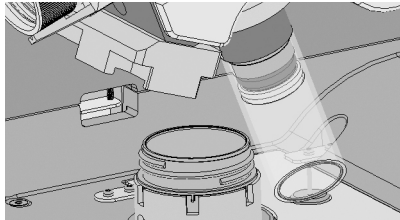
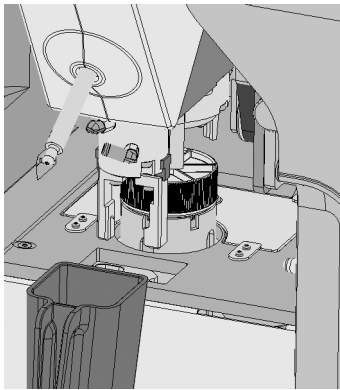
1. After the “Processing Complete” message appears on the display screen, open the door and remove the fixative bath with the slide immersed in fixative. Transfer the slide into a staining rack in an output bath containing standard laboratory fixative.

Note: If the processor detected a dense sample or a dilute sample during processing, a message appears on the display screen.

It is necessary to remove the fixative bath from the holder after each slide is processed.

Warning: The fixative bath must be removed. Evaporating alcohol could create a fire hazard.

Do not touch the slide surface. Do not touch any liquid in the fixative bath or the output bath.

Note: If any liquid contamination of gloves is suspected, discard gloves and replace with a new pair in order to avoid the risk of vial contamination.

Refer to Chapter 10, “Fixation, Staining, and Coverslipping”, for more information about slide fixation, staining and coverslipping.



OPERATING INSTRUCTIONS

2. Remove the sample vial.
Do not discard the sample vial until it has been determined that no additional slides are needed. Refer to Chapter 3, “PreservCyt® and CytoLyt® Solutions”, for information regarding solution disposal and sample storage.
3. Remove the used filter using one of the following methods:
 - A. Place a lint-free wipe around the sides of the ThinPrep filter to prevent contaminating gloves while removing the filter. Remove the used filter. Dispose of the used filter. Using a fresh, lint-free wipe, gently wipe the filter plug to remove any residual liquid before processing the next sample. Discard the used wipe.
 - B. Remove the used filter. Dispose of the filter. Using a fresh, lint-free wipe, gently wipe the filter plug to remove any residual liquid before processing the next sample. Discard the used wipe. Discard used gloves and put on a new pair of gloves before processing the next sample.

Note: Dispose of the used filter using appropriate laboratory procedures. **A ThinPrep filter must be used only once and cannot be reused.**
4. The loading process is ready to start for the next sample.

**SECTION
M****REMOVE AN ALIQUOT FROM THE SAMPLE VIAL ON THE
THINPREP GENESIS PROCESSOR****Load the Processor**

The following supplies must be loaded into the processor for the “Aliquot” process which removes a 1-ml aliquot from the sample:

- PreservCyt sample vial
- Pipette tip (The processor stores up to eight pipette tips. Pipette tips only need to be loaded when that inventory of eight is used up.)
- Tube
- Pipette tip disposal cup

1. Prepare the work area, lab bench and/or cart.
 - A. Put on clean gloves.
 - B. Wipe down work surfaces with 0.5% sodium hypochlorite solution. (Use de-ionized water to dilute 5% to 7% (0.7M to 1.0M) sodium hypochlorite solution. A prepared batch of 0.5% sodium hypochlorite solution will be effective for 1 week if it is properly stored.)
 - C. Allow the sodium hypochlorite solution to contact work surfaces for at least 1 minute, then follow with a water rinse. Dry the surfaces with paper towels.
 - D. Cover the bench with clean, plastic-backed, absorbent laboratory bench covers.
2. Open the ThinPrep Genesis processor door.
3. Enter the vial ID:

Scan the barcode on the vial label. Hold the vial approximately 3 to 5 inches (7 to 12 cm) from the barcode scanner, with the barcode label parallel to the scanner. See Figure 7-14.

Or, manually enter the vial ID on the vial label using the keypad and press **Done**.

Note: If chain of custody is disabled on the processor, the vial ID is not used by the processor.
4. Gently place the labeled, tightly capped PreservCyt vial containing the patient sample into the disperser cup until the bottom of the vial rests on the disperser cup base. Refer to Figure 7-16.

Note: If chain of custody is enabled on the processor, the vial must be placed in the holder within five seconds of entering the vial ID. If the five-second countdown expires before the vial is in the holder, follow the prompts on the screen display to enter the vial ID again.

The vial will remain loose in the disperser cup until the process begins. The processor will automatically grasp and uncap the vial during processing.

7

OPERATING INSTRUCTIONS

5. If the system includes the optional tube printer, the tube printer automatically prints the tube. Refer to “Tube Labels” on page 6.36 and “Configure the tube ID” on page 6.54 for set-up information.
6. Enter the tube ID:
Scan the barcode or manually enter the tube ID on the tube label. Hold the tube approximately 3 to 5 inches (7 to 12 cm) from the barcode scanner, with the barcode label parallel to the scanner. Or, manually enter the tube ID on the tube label using the keypad and press **Done**.

Note: If chain of custody is disabled on the processor, the tube ID is not used by the processor.

Gently place the labeled, capped tube into the tube holder until the bottom of the tube rests on the tube holder base.

Do not touch the foil top of the tube. Ensure that gloves do not touch the foil top. Follow all instructions provided by the tube manufacturer for the safe handling of the tube.

Note: If any liquid contamination of gloves is suspected, discard gloves and replace with a new pair in order to avoid the risk of aliquot or vial contamination.

If any contamination of the cap is suspected, consult the instructions provided by the tube manufacturer.

Note: If chain of custody is enabled on the processor, the tube must be placed in the holder within five seconds of entering the tube ID. If the five-second countdown expires before the tube is in the holder, follow the prompts on the screen display to enter the tube ID again.

The processor will automatically grasp and uncap the tube during processing.

The processor will run the **Aliquot** process.



Note: In this example, the lab is not using the chain of custody feature for vials and tubes.

This message does not appear if the chain of custody is enabled, and the processor requires IDs to be entered.

Figure 7-18 Load tube

7. Close the door.
8. Press the **Continue** button.

Note: If “Auto-start with Door Close” is enabled, the process starts when the door is closed, and the **Continue** button is not available.

Processing: Aliquot

This section describes the sequence of events in the “Aliquot” process on the ThinPrep Genesis processor.

Table 7.4 : Sequence of Events in Removing an Aliquot

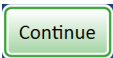
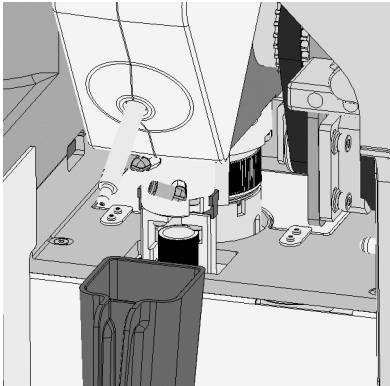
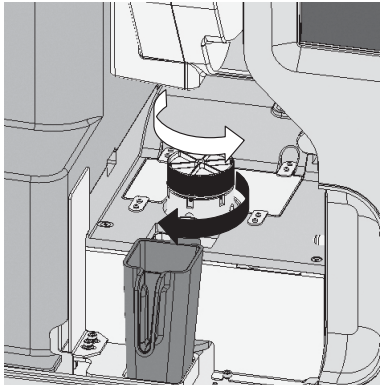
	<p>Continue button is pressed.</p>
	<p>Grasp the vial and tube and tighten the vial cap and tube cap.</p>
	<p>Spin the vial to disperse the contents.</p>

7

OPERATING INSTRUCTIONS

Table 7.4 : Sequence of Events in Removing an Aliquot



	<p>Uncap the vial, and uncap the tube.</p> <p>Retrieve the first available pipette tip from the pipette tip storage area.</p> <p>Introduce pipette tip to vial and perform level sensing to verify min./max. liquid level.</p> <p>Aspirate fluid into the pipette tip. Move the pipette tip to the tube. Dispense fluid into the tube. The pipette delivery volume accuracy is 1 ml +/- 4%, and the pipette dispenses within 2% CV.</p>
	<p>Eject used tip into the pipette tip disposal cup.</p>
	<p>Recap the tube. Recap the vial.</p>

Table 7.4 : Sequence of Events in Removing an Aliquot

	<p>Processing is complete. Unlock the door.</p>
---	---

Remove Tube, Sample and Pipette Tip Waste

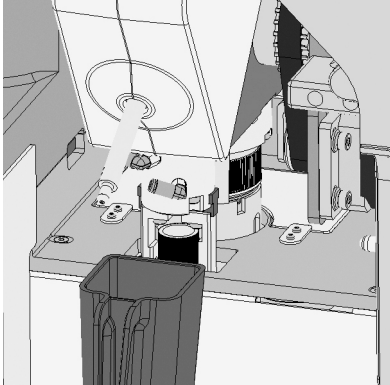
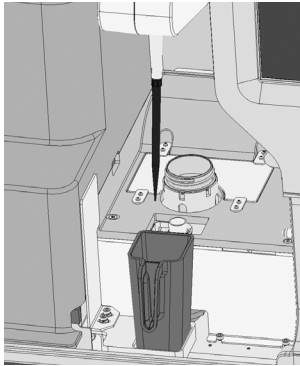
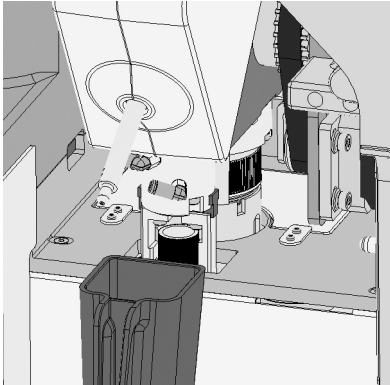
1. After the “Processing Complete” message appears on the display screen, open the door and remove the tube containing the aliquot from the patient sample. Do not touch the foil top of the tube. Ensure that gloves do not touch the foil top. Follow all instructions provided by the tube manufacturer for the safe handling of the tube.
Note: If any liquid contamination of gloves is suspected, discard gloves and replace with a new pair in order to avoid the risk of aliquot or vial contamination.
2. Remove the sample vial. Do not discard the sample vial until it has been determined that a slide is not needed. Refer to Chapter 3, “PreservCyt® and CytoLyt® Solutions”, for information regarding solution disposal and sample storage.
3. Hold the pipette tip disposal cup by its handle. Remove the pipette tip disposal cup. Do not touch the pipette tip. Do not touch the inside of the pipette tip disposal cup. Dispose of the pipette tips in accordance with all applicable standards. A pipette tip must only be used once and cannot be reused.
Note: If any liquid contamination of gloves is suspected, discard gloves and replace with a new pair in order to avoid the risk of aliquot or vial contamination.
4. The loading process is ready to start for the next sample.

SECTION
N
REMOVE AN ALIQUOT FROM THE SAMPLE VIAL AND PROCESS A SLIDE ON THE THINPREP GENESIS PROCESSOR

The following supplies must be loaded into the processor for the “Aliquot + Slide” process, which removes a 1-ml aliquot from the sample and transfers cells to a microscope slide:

- PreservCyt sample vial
- ThinPrep filter
- ThinPrep microscope slide
- Fixative bath



OPERATING INSTRUCTIONS

- Pipette tip (The processor stores up to eight pipette tips. Pipette tips only need to be loaded when that inventory of eight is used up.)
 - Tube
 - Pipette tip disposal cup
1. Prepare the work area, lab bench and/or cart.
 - A. Put on clean gloves.
 - B. Wipe down work surfaces with 0.5% sodium hypochlorite solution. (Use de-ionized water to dilute 5% to 7% (0.7M to 1.0M) sodium hypochlorite solution. A prepared batch of 0.5% sodium hypochlorite solution will be effective for 1 week if it is properly stored.)
 - C. Allow the sodium hypochlorite solution to contact work surfaces for at least 1 minute, then follow with a water rinse. Dry the surfaces with paper towels.
 - D. Cover the bench with clean, plastic-backed, absorbent laboratory bench covers.
 2. Open the ThinPrep Genesis processor door.
 3. Scan the barcode or manually enter the vial ID on the vial label.

If the ThinPrep Genesis processor is set up to use separate IDs for the cytology ID and the molecular ID, each of the IDs must be scanned or entered, in any order.
Hold the vial approximately 3 to 5 inches (7 to 12 cm) from the barcode scanner, with the barcode label parallel to the scanner. See Figure 7-14.
Or, manually enter the vial ID on the vial label using the keypad and press **Done**.

Note: If chain of custody is disabled on the processor, the vial ID is not used by the processor.

The processor will run the **Aliquot + Slide** process for a GYN sample type.

If your lab configured the ThinPrep Genesis processor to use one ID on the vial for cytology and a separate ID on the vial for molecular testing, enter both IDs on the vial.

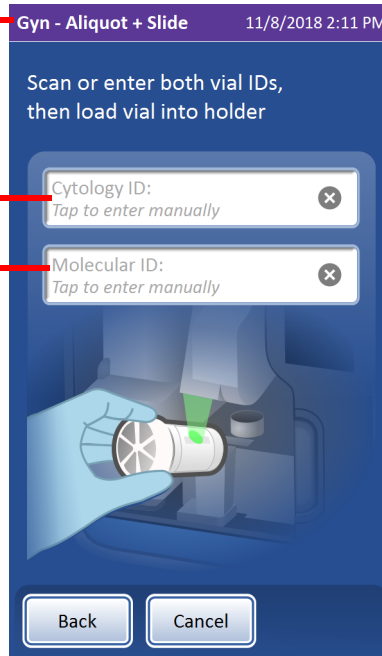

If your lab configured the ThinPrep Genesis processor to use one ID on the vial, then only one ID is entered and the field is named "Sample ID".

Figure 7-19 Enter vial ID, Cytology ID and Molecular ID shown

4. Gently place the labeled, tightly capped PreservCyt vial containing the patient sample into the disperser cup until the bottom of the vial rests on the disperser cup base. Refer to Figure 7-15.

Note: If chain of custody is enabled on the processor, the vial must be placed in the holder within five seconds of entering the vial ID. If the five-second countdown expires before the vial is in the holder, follow the prompts on the screen display to enter the vial ID again.

The vial will remain loose in the disperser cup until the process begins. The processor will automatically grasp and uncap the vial during processing. See Figure 7-16.

5. If the system includes the optional tube printer, the tube printer automatically prints the tube. Refer to "Tube Labels" on page 6.36 and "Configure the tube ID" on page 6.54 for set-up information.
6. If the system includes the optional slide printer, the slide printer automatically prints the slide. Refer to "Slide Labels" on page 6.26 and "Configure the slide ID" on page 6.52 for set-up information.
7. Scan the barcode or manually enter the tube ID on the tube label.

Note: If chain of custody is disabled on the processor, the tube ID is not used by the processor.
8. Gently place the labeled, capped tube into the tube holder until the bottom of the tube rests on the tube holder base.

7

OPERATING INSTRUCTIONS

Do not touch the foil top of the tube. Ensure that gloves do not touch the foil top. Follow all instructions provided by the tube manufacturer for the safe handling of the tube.

Note: If any liquid contamination of gloves is suspected, discard gloves and replace with a new pair in order to avoid the risk of aliquot or vial contamination.

If any contamination of the cap is suspected, consult the instructions provided by the tube manufacturer.

Note: If chain of custody is enabled on the processor, the tube must be placed in the holder within five seconds of entering the tube ID. If the five-second countdown expires before the tube is in the holder, follow the prompts on the screen display to enter the tube ID again.

The processor will automatically grasp and uncap the tube during processing. See Figure 7-18.

9. Load a labeled microscope slide into the slide nest.

It is important to load the slide facing in the proper direction so that the cell spot will end up in the correct position on the slide. Orient the slide so that the frosted, label end of the slide is on the left and facing down. Be sure not to touch the slide within the defined screening area. Place the slide so that the slide lays flat in the slide nest. See Figure 7-17.

10. Remove a new ThinPrep filter from the storage tray by grasping the sides of the cylinder.

11. Push the open end of the filter onto the filter plug.

Caution: Never touch the filter membrane of the ThinPrep filter.

Caution: For best slide preparation results, use the correct slide type and filter type for the sample type that is processed.

12. Close the door.

13. Press the **Continue** button.

Note: If “Auto-start with Door Close” is enabled, the process starts when the door is closed, and the **Continue** button is not available.

Processing: Aliquot + Slide

This section describes the sequence of events in the “Aliquot + Slide” process on the ThinPrep Genesis processor.

Table 7.5 Sequence of Events in Processing Aliquot + Slide

	<p>Continue button is pressed.</p>
---	---

Table 7.5 Sequence of Events in Processing Aliquot + Slide

	<p>Check for the presence of a new filter. Pick the slide from the slide nest. Rotate slide to horizontal position and place on cell transfer station. Rotate the filter to check that the filter is seated correctly on the filter plug.</p>
	<p>Scan the slide ID. Check the slide ID. Note: This step does not happen if chain of custody is disabled on the processor settings.</p>
	<p>Move the slide to the side. (The slide is now vertical.)</p>

7

OPERATING INSTRUCTIONS

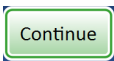
Table 7.5 Sequence of Events in Processing Aliquot + Slide

	<p>Grasp the vial and tube and tighten the vial cap and tube cap.</p>
	<p>Spin the vial to disperse the contents.</p>
	<p>Uncap the vial, and uncap the tube.</p> <p>Retrieve the first available pipette tip from the pipette storage area.</p> <p>Introduce pipette tip to vial and perform level sensing to verify min./max. liquid level.</p> <p>Aspirate fluid into the pipette tip. Move the pipette tip to the tube. Dispense fluid into the tube. The pipette delivery volume accuracy is 1 ml +/- 4%, and the pipette dispenses within 2% CV.</p>

Table 7.5 Sequence of Events in Processing Aliquot + Slide

	<p>Eject used tip into the pipette tip disposal cup.</p>
	<p>Recap the tube.</p>
	<p>Introduce filter to vial and perform level sensing to verify min./max. liquid level.</p> <p>Cell collection onto filter</p>

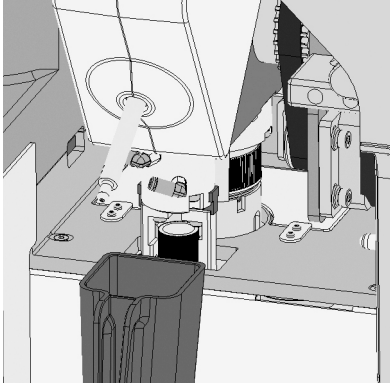
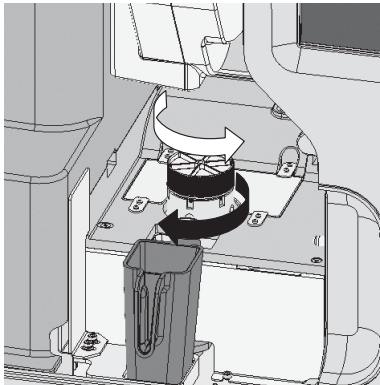
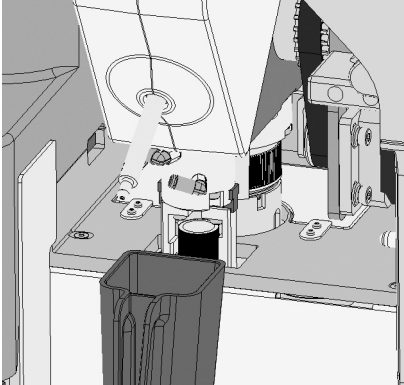

OPERATING INSTRUCTIONS

Table 7.5 Sequence of Events in Processing Aliquot + Slide

	<p>Cell transfer onto slide</p>
	<p>Deposit slide into fixative bath.</p>
	<p>Puncture filter.</p>

Table 7.5 Sequence of Events in Processing Aliquot + Slide

	Recap vial.
	Processing is complete. Unlock the door.

Remove Tube, Slide, Sample, Filter and Pipette Tip Waste

1. After the “Processing Complete” message appears on the display screen, open the door and remove the tube. Do not touch the foil top of the tube. Ensure that gloves do not touch the foil top. Follow all instructions provided by the tube manufacturer for the safe handling of the tube.

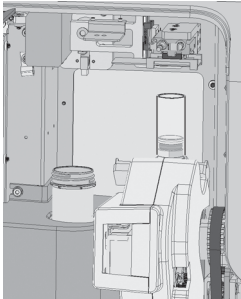
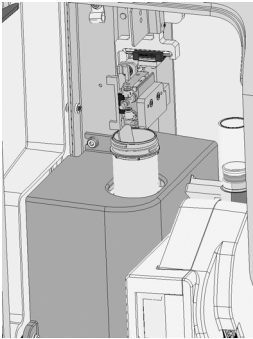
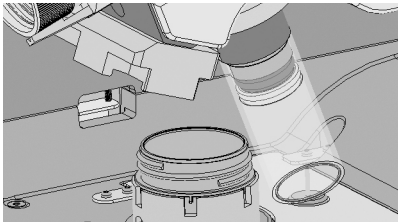
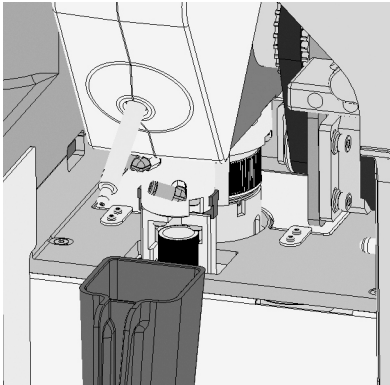
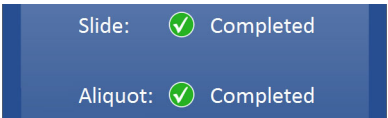
Note: If any liquid contamination of gloves is suspected, discard gloves and replace with a new pair in order to avoid the risk of aliquot or vial contamination.

2. Remove the fixative bath with the slide immersed in fixative. Transfer the slide into a staining rack in an output bath containing standard laboratory fixative.

Note: If the processor detected a dense sample or a dilute sample during processing, a message appears on the display screen.

It is necessary to remove the fixative bath from the holder after each slide is processed.

Warning: The fixative bath must be removed. Evaporating alcohol could create a fire hazard.

Do not touch the slide surface. Do not touch any liquid in the fixative bath or the output bath.

Note: If any liquid contamination of gloves is suspected, discard gloves and replace with a new pair in order to avoid the risk of aliquot or vial contamination.

Refer to Chapter 10, “Fixation, Staining, and Coverslipping”, for more information about slide fixation, staining and coverslipping.



OPERATING INSTRUCTIONS

3. Remove the sample vial. Do not discard the sample vial until it has been determined that no additional slides are needed. Refer to Chapter 3, “PreservCyt® and CytoLyt® Solutions”, for information regarding solution disposal and sample storage.
 4. Remove the used filter using one of the following methods:
 - A. Place a lint-free wipe around the sides of the ThinPrep filter to prevent contaminating gloves while removing the filter. Remove the used filter. Dispose of the filter. Using a fresh, lint-free wipe, gently wipe the filter plug to remove any residual liquid before processing the next sample. Discard the used wipe.
 - B. Remove the used filter. Dispose of the filter. Using a fresh, lint-free wipe, gently wipe the filter plug to remove any residual liquid before processing the next sample. Discard the used wipe. Discard used gloves and put on a new pair of gloves before processing the next sample.
- Note:** Dispose of the used filter using appropriate laboratory procedures. **A ThinPrep filter must be used only once and cannot be reused.**
5. Hold the pipette tip disposal cup by its handle. Remove the pipette tip disposal cup. Do not touch the pipette tip. Do not touch the inside of the pipette tip disposal cup. Dispose of the pipette tips in accordance with all applicable standards. A pipette tip must only be used once and cannot be reused.

Note: If any liquid contamination of gloves is suspected, discard gloves and replace with a new pair in order to avoid the risk of aliquot or vial contamination.
 6. The loading process is ready to start for the next sample.

SECTION
O**CANCEL SAMPLE PROCESSING**

Ordinarily, the ThinPrep Genesis processor slide preparation process or aliquot removal process should not be interrupted. However, if it is necessary to stop processing for any reason, use the following procedure to ensure the slide or tube is not contaminated with another specimen.

1. Press the **Cancel** button to cancel the process.
Wait until the display warns that the processing has been cancelled.
The ThinPrep processor will halt the process, and automatically return the motors, materials, and supplies to their starting positions.
The process can only be cancelled before the processor introduces the pipette tip or the filter to the sample in the vial.

2. Press **Next** to close the “Processing Cancelled” message screen.
3. If the cancelled process was “Slide” or “Aliquot + Slide”:
 - Remove the ThinPrep microscope slide from the slide holder.
 - Remove the filter.
4. If the cancelled process was “Aliquot” or “Aliquot + Slide”:
 - Remove the tube.
 - Empty the pipette tip disposal cup.
5. Remove the PreservCyt sample vial.

If the process is cancelled after the processor removes the cap from the vial, the vial report lists the process on the vial as a failure. If the process is cancelled before the processor removes the cap from the vial, the vial is not recorded in the vial report.

Re-run a Previously Cancelled Sample

If the **Cancel** button was pushed to cancel the process, the same sample vial can be re-run as needed.

The steps for re-running a previously cancelled sample are the same as the steps for running any sample, with one exception involving the optional tube printer or the optional slide printer.

If chain of custody is enabled on the processor, and if your laboratory uses the optional tube printer or the optional slide printer, when a previously-cancelled sample vial ID is scanned or entered, the ThinPrep Genesis processor recognizes that the vial ID has been entered previously. Rather than automatically printing the tube label or automatically printing the slide label, the processor presents a screen display for the operator to confirm or stop the printing of the tube label or the slide label. The operator can opt to use the tube or slide that was printed but never processed.



OPERATING INSTRUCTIONS

This page intentionally left blank.

Chapter Eight

Maintenance

The instrument must be maintained regularly in order to ensure reliable performance. Perform maintenance on the instrument as described in this section. The instrument requires supplemental preventive maintenance annually by Hologic personnel.

Table 8.1 Routine Maintenance

Daily or more	Change fixative every 100 slides or daily, whichever comes first.
	Clean the Slide Nest and Slide Grippers.
	Clean the pipette tip disposal cup.*
Weekly	Clean the processing area.
	Clean the pipettor.*
	Clean the touch screen.
	Clean the door and handle.
	Clean the print head on the slide printer.
	Clean the transportation rollers on the slide printer
	Clean the input roller on the slide printer
	Clean the exterior of the slide printer
As needed	Empty the waste bottle.
	Clear the pneumatic tubing lines.
	Change the absorbent pads.
	Clean the pipette tip holder.*
	Replace the slide printer ribbon.
	Replace the print head on the slide printer
	Clean the print head on the tube printer.
	Clean the exterior of the tube printer.

The logo for section 8 consists of a large blue number '8' centered within a circular arc. The arc is multi-colored, transitioning from yellow at the top to orange, then red, and finally purple at the bottom. To the right of the circle, the word 'MAINTENANCE' is written in a blue, all-caps, sans-serif font.

8 MAINTENANCE

*For laboratories that do not routinely use the Aliquot sequence or the Aliquot + Slide sequence on the ThinPrep Genesis processor, the maintenance activities related to pipetting can be performed on an “as needed” basis, needed only when the Aliquot sequence or the Aliquot + Slide sequence is used.

The multi-channel pipette tip gripper may require routine maintenance. Follow the manufacturer’s instructions provided with the multi-channel pipette tip gripper.

Any procedure not described in this section requires specially trained personnel. Contact Hologic Technical Support for more information.

SECTION
A

DAILY

Change Fixative Reagent

The fixative alcohol in the fixative bath should be changed out every 100 slides, or daily, whichever comes first.

- Remove the fixative bath from the processor.
- Dispose of fix reagents according to your laboratory's protocols.
- Clean the fixative bath according to your laboratory's protocols.
- Replenish the fixative alcohol in the fixative bath.

Clean the Slide Nest and Slide Grippers

Wipe any glass dust and debris from the slide nest and the slide grippers in the ThinPrep Genesis processor with a lint-free wipe, dampened with de-ionized water. Then, wipe the slide nest and slide grippers with a lint-free wipe, moistened with 70% alcohol. Allow the slide nest and slide grippers to dry before using the processor.

WARNING: Sharp edges

The slide gripper fingers have sharp edges. Use caution when cleaning the slide gripper fingers.

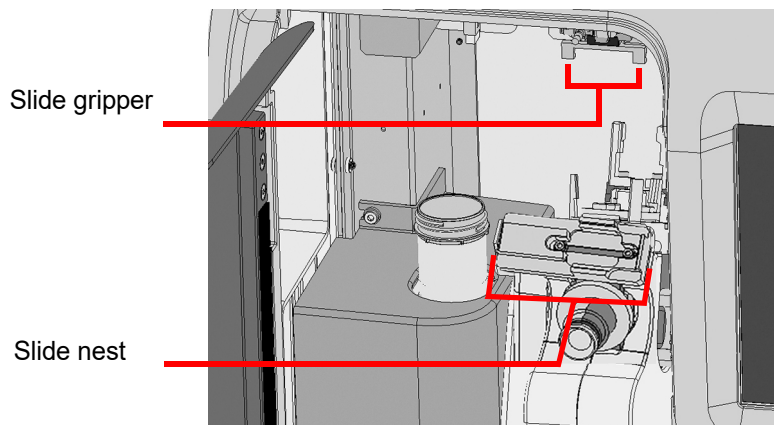

Figure 8-1 Slide nest and slide gripper

WARNING: Glass

The instrument uses microscope slides, which have sharp edges. In addition, the slides may be broken in their storage packaging or on the instrument. Use caution when handling glass slides and cleaning the instrument.

8 MAINTENANCE

Clean the Pipette Tip Disposal Cup

As needed, remove the pipette tip disposal cup for cleaning.

1. Clean with soap and water. The cup is dishwasher safe.

Or,

2. Rinse it first with a diluted bleach solution, rinse it next with de-ionized water, and then rinse it with 70% alcohol.

SECTION B

WEEKLY CLEANING

Clean the Processing Area

In general, be sure to clean up spills when they occur. Use a lint-free wipe to absorb any spills and then wipe the area of the spill with a lint-free wipe dampened with 70% alcohol.

On a weekly basis, clean around the bottom of the processing area, using 70% alcohol and lint-free wipes. Wear gloves while cleaning. See Figure 8-2.

- Gently wipe the sensor on the wall to the left of the vial holder.
- Gently wipe the barcode scanner.
- Do not spray the interior of the processor with water or any cleanser.
- Do not touch the pipettor when wiping down the surface of the robot, as a bend may lead to a bad seal with the pipette tip.
- Pull out the drip tray to wipe it clean.

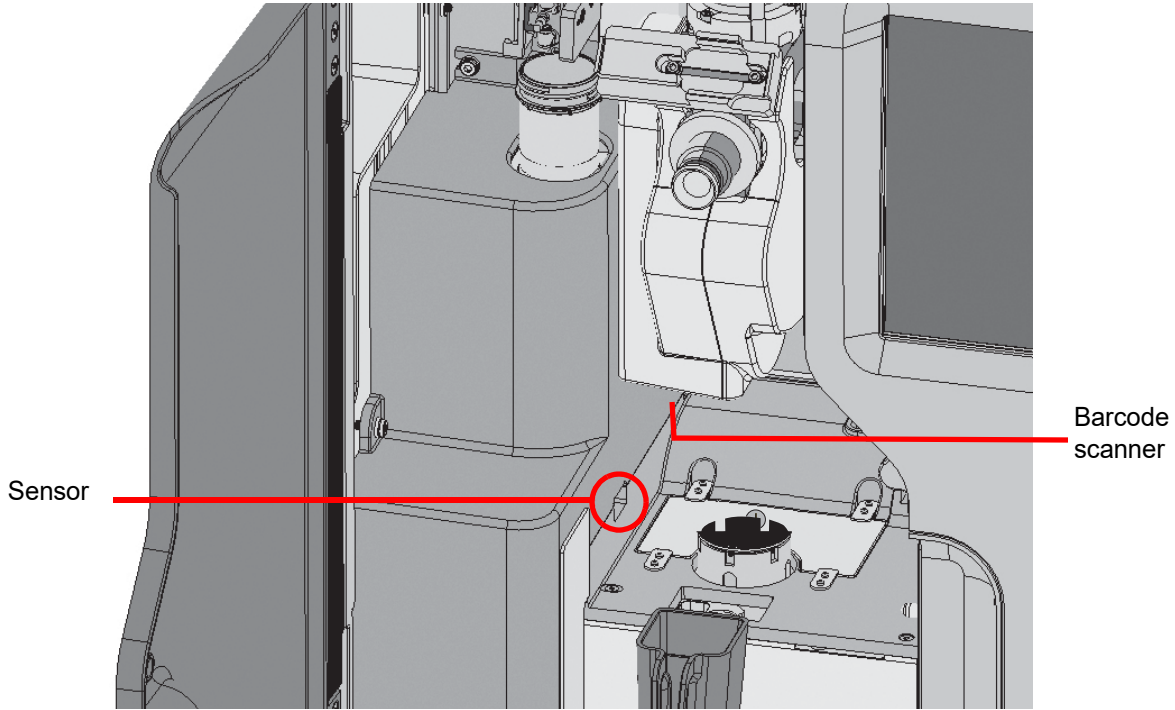

Figure 8-2 Clean sensor and scanner with moistened, lint-free wipe

Clean around the vial holder, the filter plug, and filter puncture area.

If there is buildup of residue from PreservCyt Solution in and around the vial holder, on the filter plug and around the filter puncture point area, use a cloth or swab soaked with 70% alcohol to dissolve any crust and clean away precipitate. See Figure 8-3.

If there is buildup of residue from PreservCyt Solution on the filter plug, after cleaning the filter plug, press the **Jog Filter** button. This quickly moves the filter plug and helps seat the cleaned filter plug properly. To access the **Jog Filter** button, from the main menu, select **Admin Options** and then select **System Maintenance**.

8

MAINTENANCE

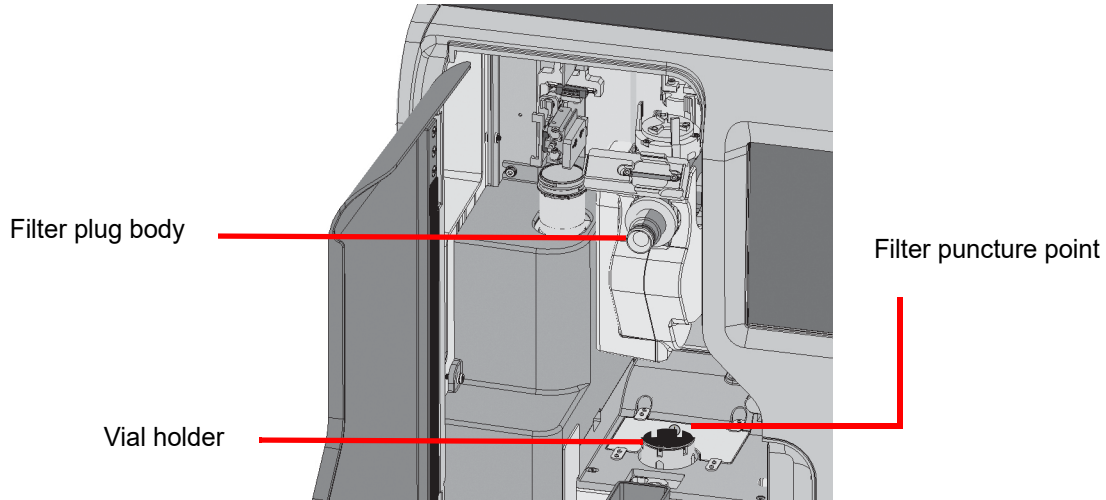

Figure 8-3 Clean vial holder, filter plug and filter puncture area

Clean the Pipettor

Clean the pipettor with a lint-free wipe, dampened with de-ionized water, followed by a wipe-down with a lint-free wipe moistened with 70% alcohol. Wipe the pipettor in an up-and-down motion. Allow it to dry before using the processor.

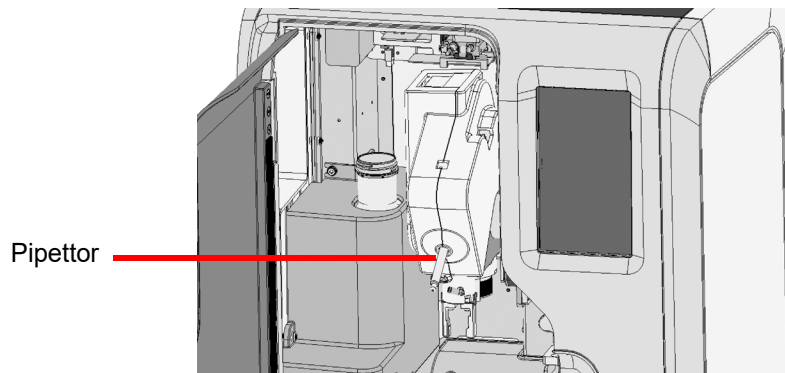

Figure 8-4 Clean the pipettor

Clean the Touch Screen

Clean the user interface touch screen with a lint-free cloth lightly dampened with 70% alcohol.

1. From the Main Menu, select **Admin Options**. Then, select **System Maintenance**.
2. Select **Clean Screen**.

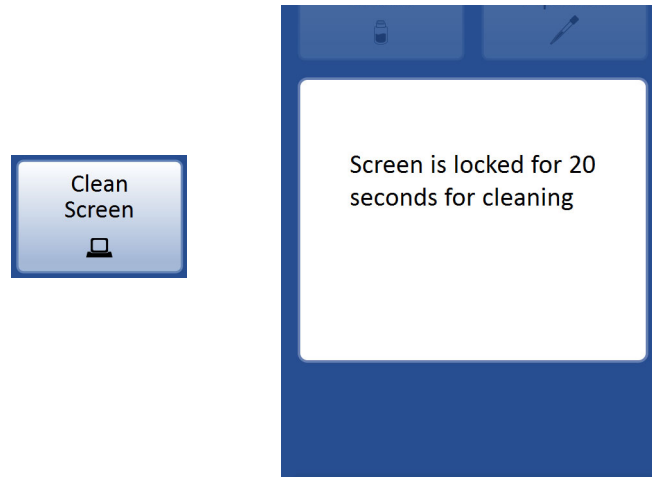

Figure 8-5 Touch screen disabled for cleaning

The system disables the touch screen for 20 seconds so that the screen may be cleaned without inadvertently activating buttons or having to power off the processor.

Caution: Do not put the door or the touch screen on the processor in contact with strong solvents such as xylene, which may damage the surface of the door or the touch screen.

Clean the Door and Handle

The door and the door handle on the ThinPrep Genesis processor may become dirty over time. To clean the door and its handle, it is best to use a commercially available glass cleaner. Open the door and clean the inside surface of the window with a lint-free wipe. Close the door and clean the outside surface of the door's window and the door handle with a lint-free wipe.

Clean the Print Head in the Slide Printer

For ThinPrep Genesis systems using the optional slide printer, use the print head cleaning pen and polishing paper supplied with the slide printer to clean the print head.

Clean the slide printer print head each time the printer ribbon is replaced, or if there is a problem with the quality of the printer output, such as a vertical line through the entire print.

To clean the print head:

1. Turn off communication between the ThinPrep Genesis and the slide printer using the ThinPrep Genesis touch screen. From the Main Menu, touch the **Admin Options** button and then touch the **Slide Printer** button. The grey circle indicates communication to the slide printer is off.
2. Press the power button on the upper right side of the slide printer to turn the printer off.
3. Unplug the power from the slide printer.

8 MAINTENANCE

4. Press the cover release button on the front left of the slide printer to open the top cover. The print head is connected to the top cover.

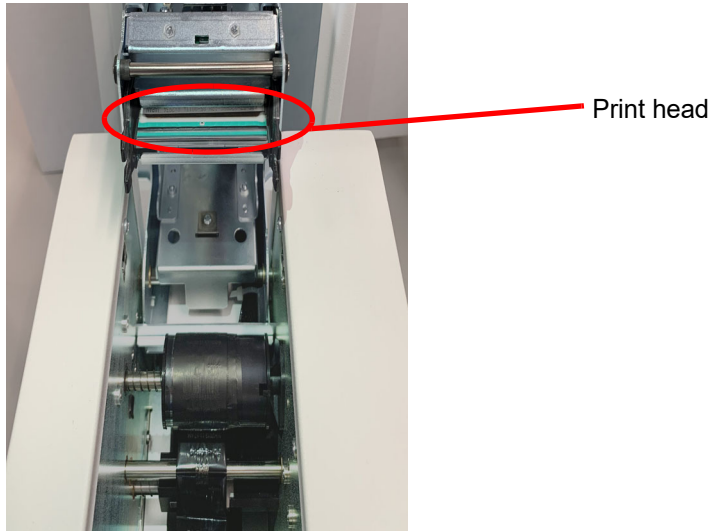

Figure 8-6 Slide printer print head

5. Wipe the tip of the cleaning pen across the flat surface of the print head one or two times. If the pen tip gets dirty, wipe the tip of the cleaning pen on a clean piece of paper.

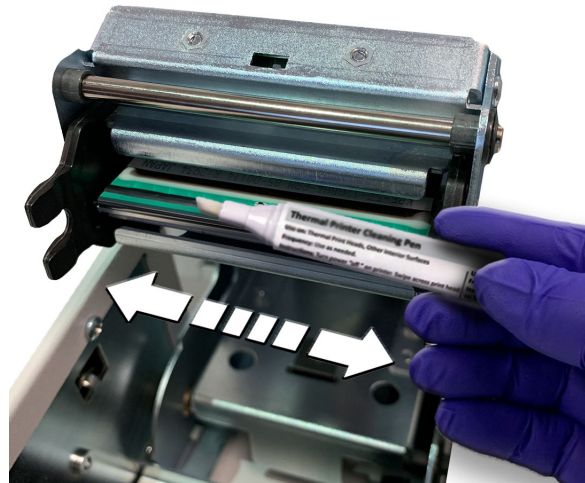

Figure 8-7 Wipe cleaning pen across slide printer print head

Note: Do not touch the print head with anything that could scratch it, such as a ring on your finger.

6. If the cleaning pen does not remove all of the debris, gently rub the polishing paper over the burn line to help remove any built-up debris.

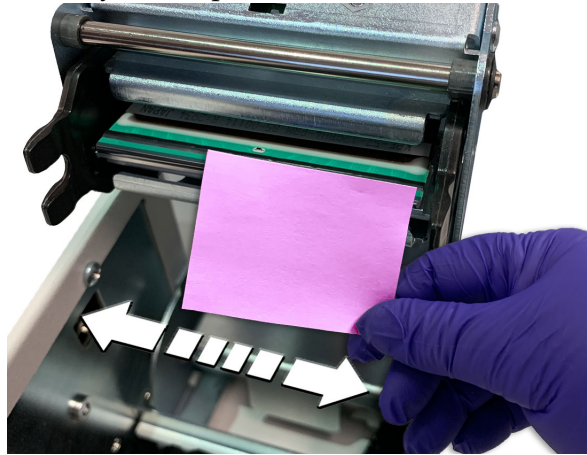

Figure 8-8 Use the polishing paper on the slide printer

7. Close the top cover.
8. Plug the slide printer power supply into a grounded outlet.
9. Turn on communication between the ThinPrep Genesis and the slide printer using the ThinPrep Genesis touch screen. From the Main Menu, touch **Admin Options** and then touch the **Slide Printer** button. The green circle indicates communication to the slide printer is on.
10. Press the power button on the upper right side of the slide printer to turn the printer on. The light illuminates the slide cartridge blue.

Clean the Transportation Rollers in the Slide Printer

For ThinPrep Genesis systems using the optional slide printer, clean the dust and debris from the transportation rollers on the slide printer. The frequency of cleaning the transportation rollers depends on how often slides are printed, usually around every 1000 slides. Note that this may differ depending upon the requirements in your lab.

To clean the transportation rollers:

1. Press the cover release button on the front left of the slide printer to open the top cover.
2. Remove the ribbon. Refer to “Replace the Slide Printer Ribbon” on page 8.21.
3. Locate the transportation rollers. The upper and lower transportation rollers are in the back. The roller platen and the front transportation rollers are in the front. In the following picture, the upper-front roller is visible. The lower-front roller is underneath and is not visible.

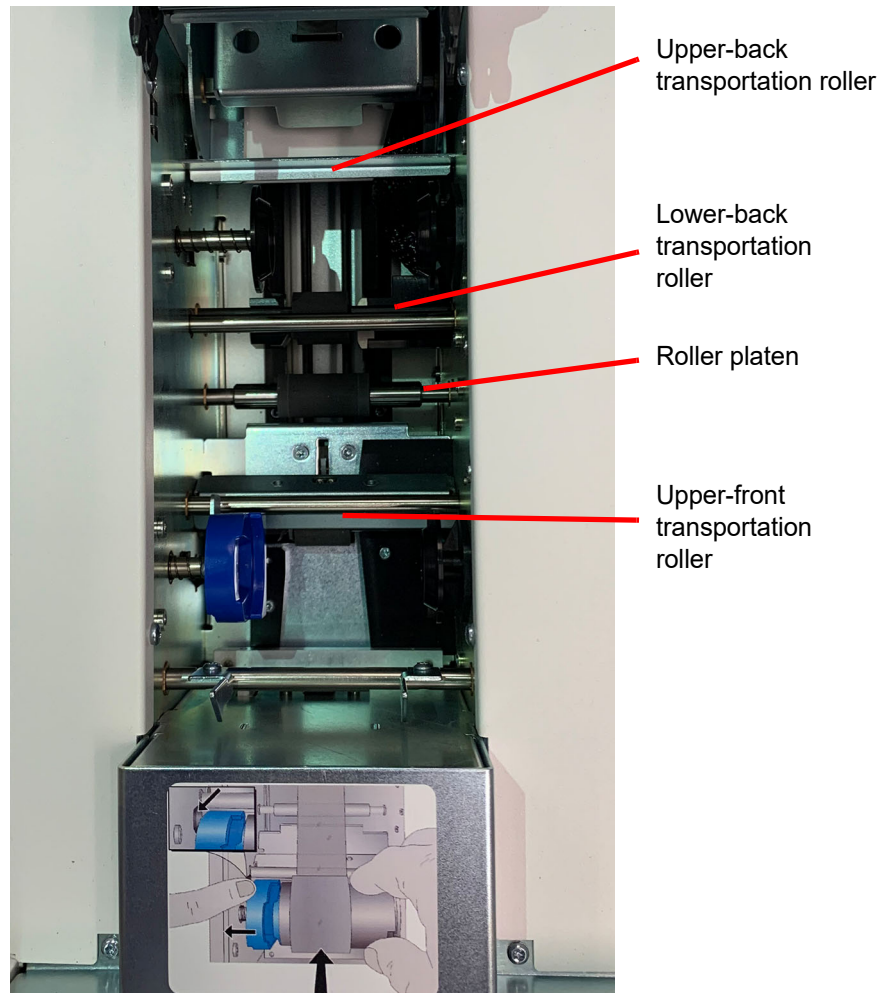

Figure 8-9 Slide printer transportation rollers

4. Start with the back transportation rollers. Use a lint-free cloth dampened with isopropyl alcohol, and press the cloth against the upper transportation roller.
5. Press one of the two buttons on the upper right of the front panel. The top button (power button) turns the roller backward. The bottom button (slide eject) turns the roller forward. (Using the bottom button will prevent the cloth from dragging between the rollers.)

Note: If you press the power button and if there is a slide present, the slide moves to the back. If you press the Slide button and there is a slide present, the slide moves to the front.

6. Keep the button pressed until the roller has turned at least once. Pressing the cloth against the turning roller cleans the roller.

7. Press the cloth against the turning roller, moving the cloth back and forth and from side to side. If needed, continue with a clean part of the cloth until the roller no longer makes the cloth black.
8. Repeat the procedure with the lower roller.



Figure 8-10 Wipe the slide printer transportation rollers

9. Next, clean the roller platen. Use a cloth dampened with alcohol. Press and hold the power button while pressing the cloth against the platen. Repeat until the platen no longer makes the cloth black, indicating the platen is clean.
10. Clean the front transportation rollers. The upper transportation roller can be reached from the top, but the lower transportation roller cannot be accessed directly and will only be cleaned indirectly by cleaning the upper transportation roller. Repeat the process as in steps 4-6.

Clean the Input Roller on the Slide Printer

For ThinPrep Genesis systems using the optional slide printer, clean the input roller on the slide printer. The input roller advances a slide from the slide cartridge in the slide printer. If debris and dirt accumulate, the input roller may not be able to take in the slides properly.

To clean the input roller:

1. Remove the slide cartridge.

8 MAINTENANCE

- Using a lint-free cloth dampened with alcohol and your gloved finger, move the cloth diagonally over the input roller. Rotate the roller by pushing or pulling to clean the entire roller. Rotate and wipe the input roller to continue cleaning.



Figure 8-11 Clean the input roller on the slide printer

- Use another part of the cloth, dampen it again with alcohol, clean the roller and check if debris from the roller is still turning the cloth black. If it is still black, repeat the cleaning using another diagonal direction. If the cloth is light gray and no longer black, the cleaning is finished.

Clean the Exterior of the Slide Printer

For ThinPrep Genesis systems using the optional slide printer, as needed, wipe the exterior surfaces with a lint-free wipe dampened with de-ionized water.

Remove the slide cartridge and wipe all surfaces of the empty slide cartridge with a lint-free wipe dampened with de-ionized water and allow the cartridge to dry completely before loading it. Wipe the roller belt in the slide printer that advances a slide from the cartridge.

On the bottom surface of the slide printer, slide the metal tray to the left or to the right to remove the tray. Wipe the tray with a lint-free wipe dampened with de-ionized water to remove any glass dust. Slide the tray back into position. The hole in the tab on the tray aligns with the screw on the left side of the printer. Make sure the hole and the screw are lined up to lock the tray in place.

SECTION
C

AS NEEDED CLEANING AND MAINTENANCE

Empty the Waste Bottle

Waste resulting from sample processing is routed to and stored in the waste bottle.

The processor senses when the waste bottle is full and displays a message to empty the waste (see Figure 8-12). Or the waste may be emptied during routine maintenance of the processor.

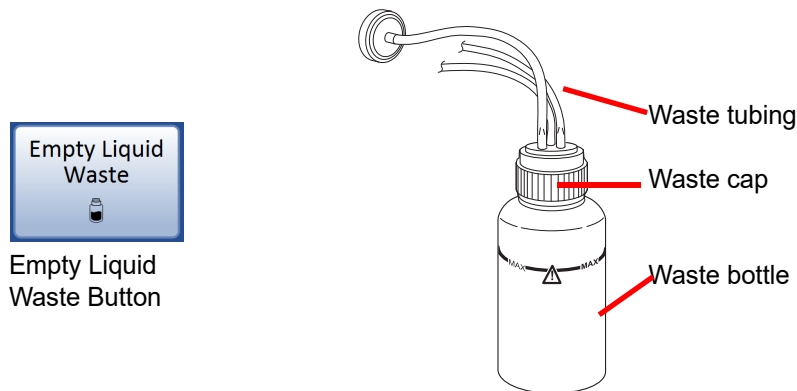

Figure 8-12 Waste bottle

4. Disable the waste system —

- From the Main Menu, select **Admin Options**. Then, select **System Maintenance**.
- Select **Empty Liquid Waste**.
- Remove all the disposables from processor and press **Next**.
- Wait for the system to vent the waste bottle, so that the cap can easily be removed. This will take approximately 10 seconds. The screen display changes to the Remove waste cap screen when the venting is finished.



MAINTENANCE

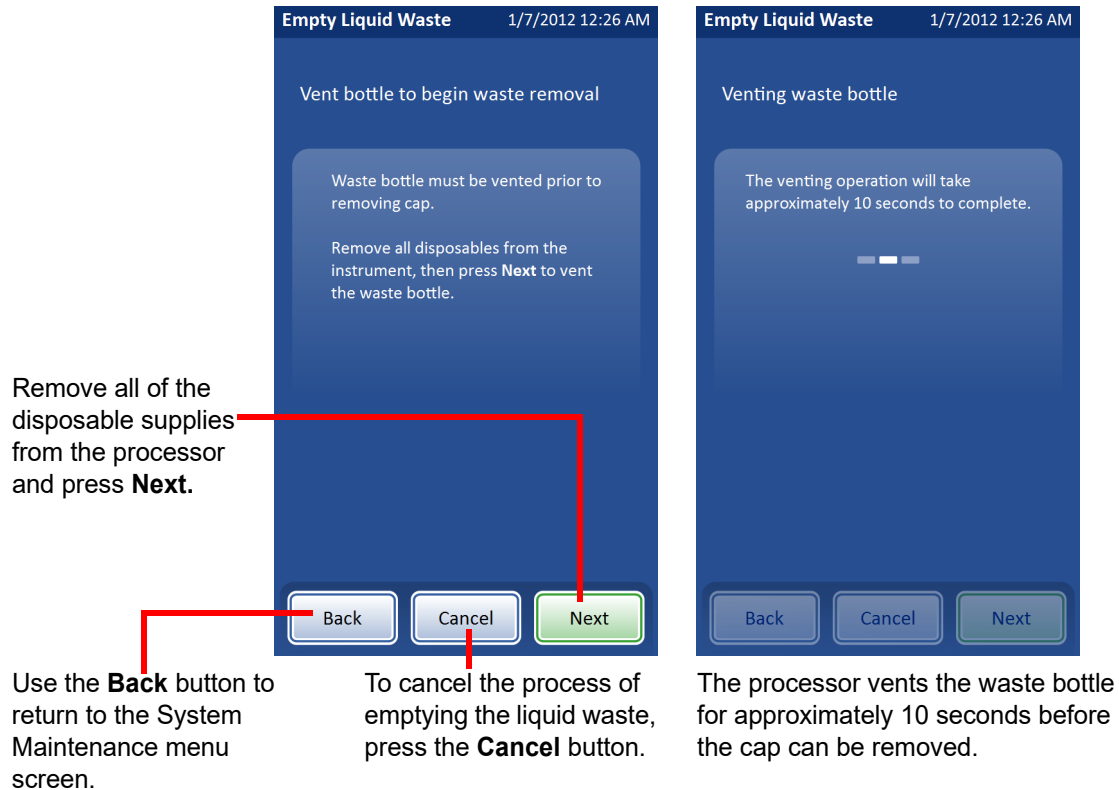
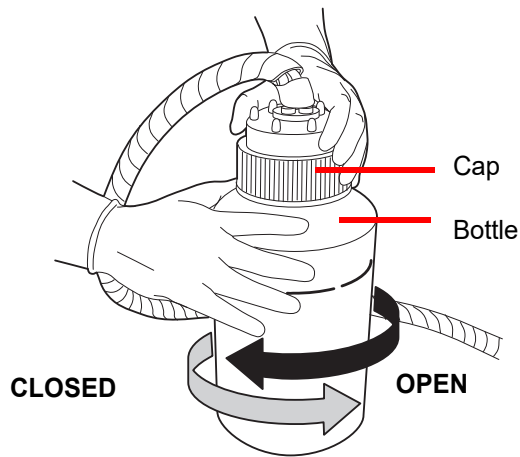

Figure 8-13 Disable the waste system

5. **Cap removal** — Open the waste bottle cap by rotating the waste cap while holding the bottle in place to avoid tangling the waste tubing. See Figure 8-14.
 - Do not remove the length of tubing connected to the inside of cap.
 - If the waste tubing becomes dislodged from the waste cap during this process, reconnect the tubing before continuing.
 - Press **Next**.



Rotate the cap to remove it.
Press **Next** to continue.

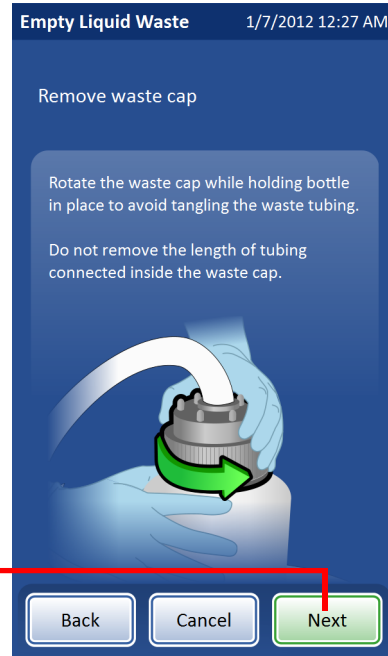

Figure 8-14 Opening/closing the waste bottle

6. **Transport cover** — A plain cap without tubing fittings is included with the ThinPrep processor for transporting the waste bottle. Place this cover on the waste bottle when transporting to the disposal area.
7. **Waste disposal** — With the transport cover on the waste bottle, transport the waste bottle to the waste disposal area.

WARNING: Hazardous Waste. Toxic Mixture. Flammable Liquid and Vapor

8. Dispose of the liquid waste from the waste bottle according to your laboratory guidelines. Dispose of all solvents as hazardous waste. Follow state, local, provincial and federal or county guidelines. As with all laboratory procedures, universal precautions should be

followed. PreservCyt Solution contains methanol. See Chapter 3, “PreservCyt® and CytoLyt® Solutions”, for more information about PreservCyt Solution. Press **Next**.

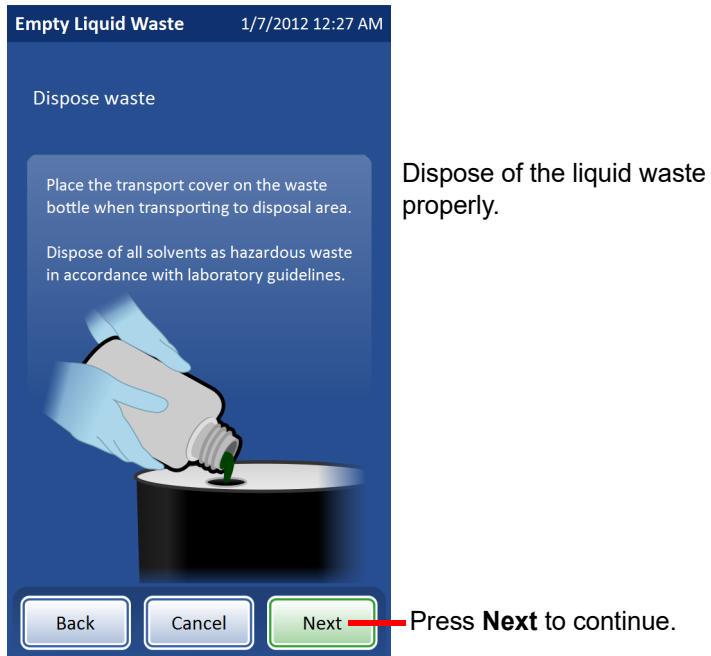

Figure 8-15 Dispose of waste bottle contents

9. **O-ring seal** — Before reattachment, inspect the O-ring seal located on the inside of the waste cap for any debris. See Figure 8-16.
If debris is present:
 - Clean the seal with water using a lint-free wipe.
 - Apply a thin layer of vacuum grease to the O-ring

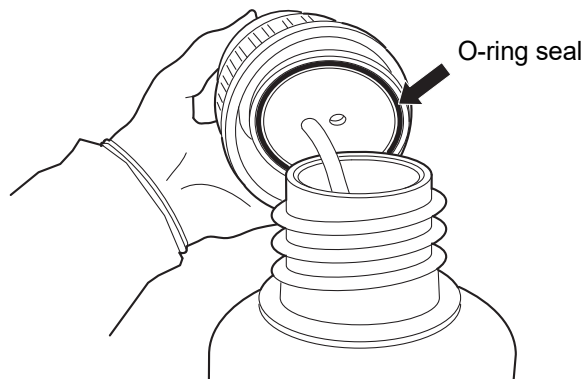

Figure 8-16 Inspect waste bottle O-ring seal

10. **Cap replacement** — Return the waste bottle back to its original location. Replace the waste cap onto the bottle being careful not to pinch the tubing located on the inside of the waste cap assembly.
11. **Inspection** — Make sure the waste cap is firmly tightened. The waste cap must be tight for proper waste bottle operation.

Check that the waste tubing between the waste bottle assembly and the ThinPrep processor is not pinched or twisted.

Check that the quick disconnect fittings located at the rear of the ThinPrep processor are secure.

12. **Leak test** — Press **Next** to perform a mandatory leak test. This repressurizes the waste bottle and checks that the system can hold pressure. This will take up to two minutes. After a successful test, press **Finish** to return to the main menu.

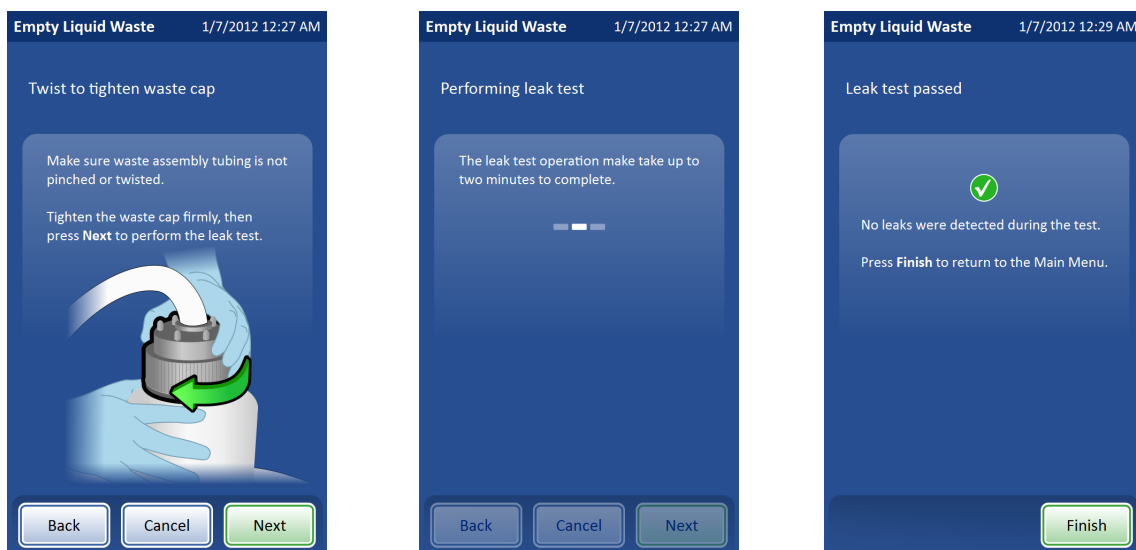

Figure 8-17 Tighten cap and perform waste system leak test

Waste Bottle Connection

The waste bottle will be connected to the system at the time the processor is installed. However, if the waste bottle and the tubing harness should be removed entirely (for overall replacement, replacement of the waste filter, cleaning, etc.) the following steps describe connecting the tubing correctly.

1. The waste bottle should be placed at the same height or below the ThinPrep Genesis processor. Do not place the waste bottle above the processor.
2. Ensure that the waste bottle cap is tightly secured. The waste bottle must rest in an upright position. Do not allow the waste bottle to lay on its side.

8 MAINTENANCE

3. Locate the three waste bottle connections at the rear of the ThinPrep Genesis processor. See Figure 8-18. Ensure that the buttons of the connectors are in the down/inward position.

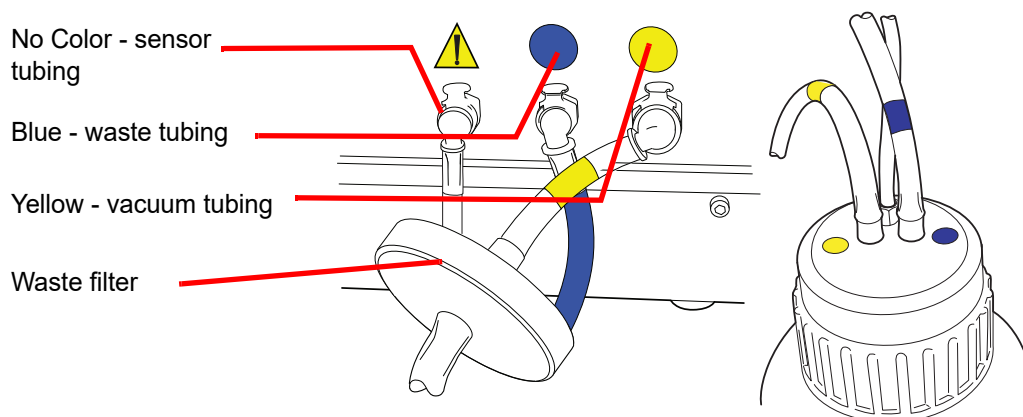

Figure 8-18 Waste bottle tubing connections

4. Connect the color-coded waste tubing connectors to the corresponding connectors located in the rear of the processor. When the proper connection has been established, the buttons on the connectors pop up/outward with a click sound. The L-shaped connector should be pointed downward.
 - Yellow = vacuum
 - Blue = waste
 - No Color = pressure sensor

Caution: Do not mismatch tubing connections. This may result in damage to your processor.

Clear Lines

The Clear Lines feature sends air through the pneumatic tubing connected to the filter plug, moving any moisture droplets that may be in the tubing. Clear the lines when advised by Hologic Technical Support.

1. From the Main Menu, press **Admin Options**, then **System Maintenance**, and then **Clear Media**.
2. Clear all media (slide, vial, vial cap, filter, tube, tube cap, or pipette tip that may have been left in process) from the processor.
3. Close the door.
4. On the Clear Media screen, press **Clear Lines**. The pump/compressor starts and pushes air through the line by changing the pressure in the pneumatic tubing. Clearing the lines will take up to two minutes.

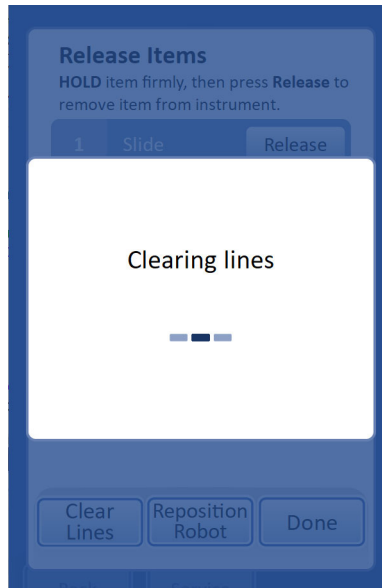

Figure 8-19 Clearing lines

5. After successfully clearing the lines, press **Done** to return to the main menu.

Change Absorbent Pads

There are two absorbent pads on the ThinPrep® Genesis processor that absorb drips that may result from processing. One pad is located at the base of the filter plug, and one pad surrounds the filter puncture area behind the vial dispersion area. See Figure 8-20.

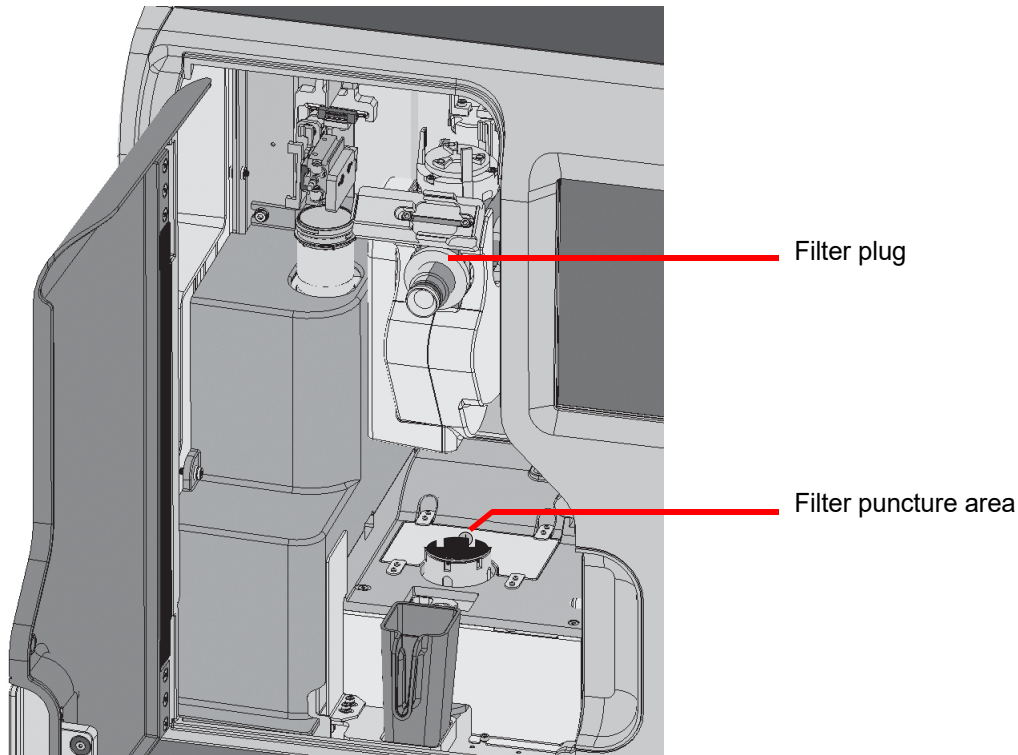

Figure 8-20 Absorbent pads

Replace the pads once a year, or as desired. The pads can be disposed of as regular waste, unless they are dripping wet, then dispose of them as hazardous waste.

Grasp the pad around the filter plug and pull it to remove it. Push the new pad into place.

The pad in the filter puncture area sits in a recessed area. Pry the pad up from the recessed area using a flat-head screwdriver as a lever. Place the new pad into the recessed area.

When the pads are replaced, notice that one side is rough and absorbent, and one side is smooth and finished. The rough side should face outward to catch any drips.

Refer to Ordering Information for part numbers and other information regarding the ordering of pads.

On a more frequent basis if desired, the pads can be washed and returned to the processor. Clean with soap and water. Or soak in a diluted bleach rinse followed by a 70% alcohol rinse.

Clean the Pipette Tip Holder

As needed, remove the pipette tip holder for cleaning. To clean the pipette tip holder, follow the Load pipette tips process as described in Chapter 7. With the pipette tip holder removed from the

processor, wipe the exterior surfaces with a lint-free wipe dampened with de-ionized water. The pipette tip holder is dishwasher safe and can be cleaned with soap and water. To thoroughly clean the pipette tip holder, rinse it first with a diluted bleach solution, rinse it next with de-ionized water, and then rinse it with 70% alcohol. Allow enough time for the holder, including the holes that hold the tips, to dry completely.

Replace the Slide Printer Ribbon

For ThinPrep Genesis systems using the optional slide printer, the printer ribbon needs to be replaced when it is all used up. The ribbon typically lasts for approximately 5000 prints. The timing depends on how many slides a laboratory prints.

The slide printer ribbon must be the ribbon available from Hologic. The printer will not function if it has the wrong ribbon in it.

1. Remove a new slide printer ribbon from its packaging. The slide printer ribbon uses two spools: a supply ribbon spool and a take-up ribbon spool.
2. Press the cover release button on the front left of the slide printer to open the top cover.

Note: Do not touch the print head with anything that could scratch it, such as a ring on your finger.

3. Install the supply ribbon spool. Follow the diagram near the supply ribbon spool inside the printer.
 - Hold the supply ribbon spool so that the blue end of the spool lines up with the blue portion of the spring-loaded hub in the printer.
 - Push the metal tab on the blue spring-loaded hub towards the edge of the printer (push left) to widen the area.
 - Rotate the supply ribbon spool so that the notches on the blue plastic line up with the notches in the blue hub. Place the spool straight down in the printer. Release the metal tab. The spool rotates freely.
4. Install the take-up ribbon spool.
 - If the ribbon is not attached to the take-up spool, use a piece of tape to attach the ribbon to the spool. The feed coming off the bottom of the supply ribbon spool goes to the bottom of the take-up spool.
 - Push the spring-loaded hub towards the edge of the printer (push left) to widen the area.
 - Rotate the take-up ribbon spool so that the notches on the spool match up with the hubs on the spool holder. Place the spool straight down in the printer. Release the spring-loaded hub. Turn the take-up ribbon spool until the ribbon is taut.
5. Close the top cover. The light illuminates the slide cartridge blue. If the ribbon has not been properly replaced, the light will not illuminate the slide cartridge and an error message will display on the ThinPrep Genesis processor screen display if the slide printer is unable to print.

Replace the Print Head in the Slide Printer

For ThinPrep Genesis systems using the optional slide printer, the print head may need to be replaced if print quality problems persist after cleaning the slide printer print head. Print heads are designed to last tens of thousands of prints. However, printing at a high heat setting, in a hot environment or on the wrong slides may wear out a print head. Only use slides designed for use with the ThinPrep Genesis processor in the slide printer.

To replace the print head on the Hologic slide printer:

1. Turn off communication between the ThinPrep Genesis and the slide printer using the ThinPrep Genesis touch screen. From the Main Menu, touch the **Admin Options** button and then touch the **Slide Printer** button. The grey circle indicates communication to the slide printer is off.
2. Press the power button on the upper right side of the slide printer to turn the printer off.
3. Unplug the power from the slide printer.
4. Press the cover release button on the front left of the slide printer to open the top cover. The print head is connected to the under side of the top cover. See Figure 8-6.
5. Unscrew the silver wire that connects the housing to the print head. Use a 2-mm Allen wrench. Save the screw to reattach the wire.
6. Firmly push the print head toward the back of the printer, then press the print head down.
7. Turn the print head completely over, 180 degrees. The cable connector will be exposed.

After the print head is flipped, follow the pin track to release print head.

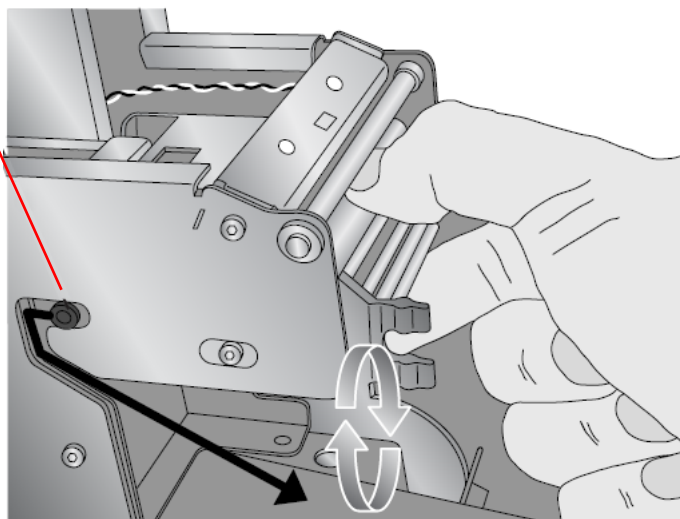
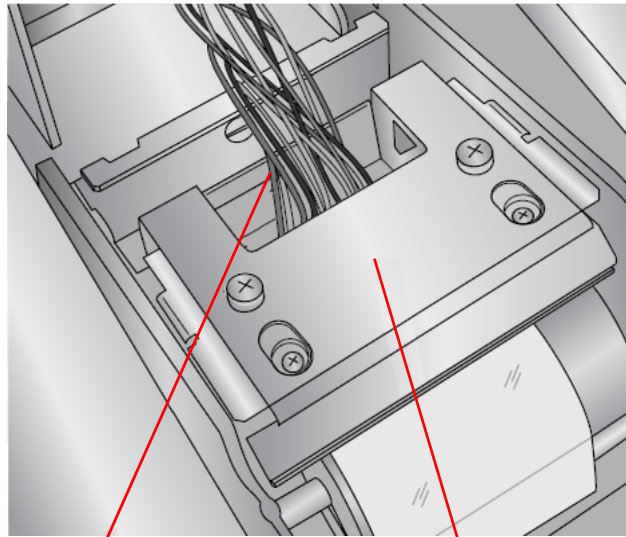

Figure 8-21 Removing the print head

8. Slide the print head out by using the tracks on both sides of the print head mechanism to guide the print head from its metal housing.

9. Disconnect the cable connection by pulling the cable from its connector on the print head.



Cable is connected to print head.
Pull from connector to remove.

Print head turned
180 degrees

Figure 8-22 Cable connection exposed when print head is flipped

10. Discard the old print head.

Connect the new print head

To connect the new print head:

1. Attach the cable connection on the printer to the connector on the new print head.
2. Place the new print head in its metal housing by sliding it back into the metal housing, reversing the same pin track used to remove it. Listen for the click.
3. Reattach the silver wire from the housing to the print head.
4. Close the cover.
5. Plug the slide printer power supply into a grounded outlet.
6. Turn on communication between the ThinPrep Genesis and the slide printer using the ThinPrep Genesis touch screen. From the Main Menu, touch **Admin Options** and then touch the **Slide Printer** button. The green circle indicates communication to the slide printer is on.
7. Press the power button on the upper right side of the slide printer to turn the printer on. The light illuminates the slide cartridge blue.

Clean the Print Head in the Tube Printer

For ThinPrep Genesis systems using the optional tube printer, the print head in the tube printer requires cleaning periodically. The timing depends on how many tubes a laboratory prints.

Unplug the power from the tube printer. Moisten a long-handled, wooden cotton-tipped swab with isopropyl alcohol. The swab should not be so wet that it drips.

The print head is the flat, shiny surface on the left-hand side of the tube cavity. Gently wipe the swab across the print head to wet and clean off the buildup. Use multiple swabs if necessary.

Note: If any residue drops off the print head and down the cavity, you may want to use tweezers to remove any particles that drop inside the printer.

Dispose of the dirty swab as regular waste. Plug the printer back into the power supply.

Clean the Exterior of the Tube Printer

For ThinPrep Genesis systems using the optional tube printer, as needed, wipe the exterior surfaces with a lint-free wipe dampened with de-ionized water.

SECTION D

MOVING THE THINPREP® GENESIS PROCESSOR

If it becomes necessary to change the location of your ThinPrep Genesis processor, follow the procedure described below.

Unit Moved Within Building:

1. Shut down the processor. Turn off power.
2. Disconnect power cord from the electrical outlet and processor.
3. Empty the waste bottle.
4. Disconnect waste bottle from the processor at connector fittings.
5. Disconnect the slide printer and tube printer, if used.
6. With the help of another person, hold the processor level and carefully place the ThinPrep processor onto the flat surface of a cart. Roll the unit to its new location.
7. With the help of another person, lift the unit from the cart and place it onto its new surface.
8. Reconnect the power cord and waste bottle. Reconnect the slide printer and tube printer, if applicable.

**Unit Shipped to New Location:**

If the ThinPrep Genesis processor is to be shipped to a new location, please contact Hologic Technical Support. Refer to Chapter 12, Service Information.

SECTION E REPLACING THE USER ACCESSIBLE FUSES

WARNING: Instrument Fusing.

There are two user-accessible fuses located on the rear of the processor, just above the power cord module (Figure 8-23). If the processor fails to operate, the fuses can be replaced as outlined below.

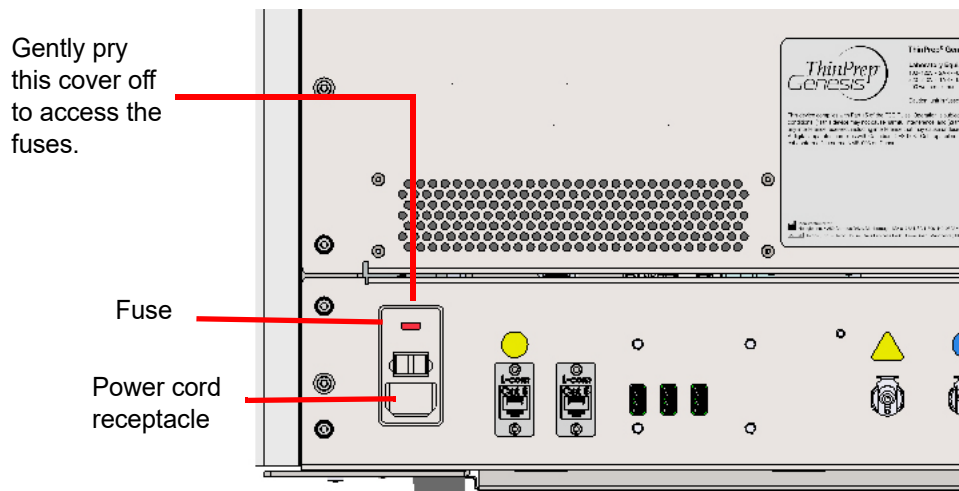

Figure 8-23 Location of user-accessible fuses

1. Shut down the processor. Make sure the power switch is in the “off” position.
2. Remove the power cord from the receptacle on the processor.

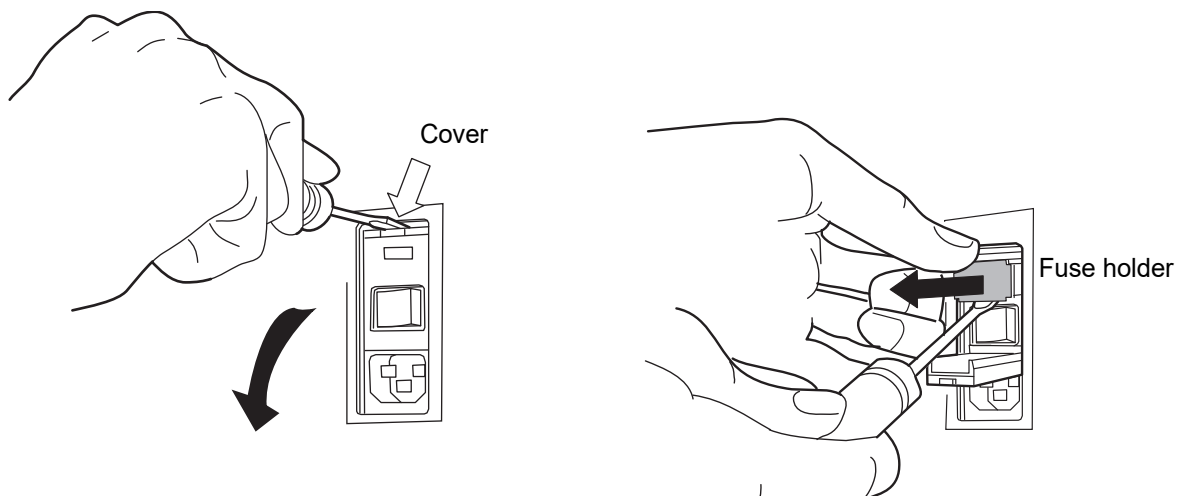

Figure 8-24 Remove the fuse holder

3. Using a small, flat-head screwdriver, pry the cover near the power cord receptacle open. Pry out the fuse holder.
4. Pull the two fuses out of the receptacles on the holder. They may be discarded as regular waste.
5. Insert two new 10A/250V 3AG fuses (P/N CKB-00112).

Note: Hold the fuse by the metal ends.

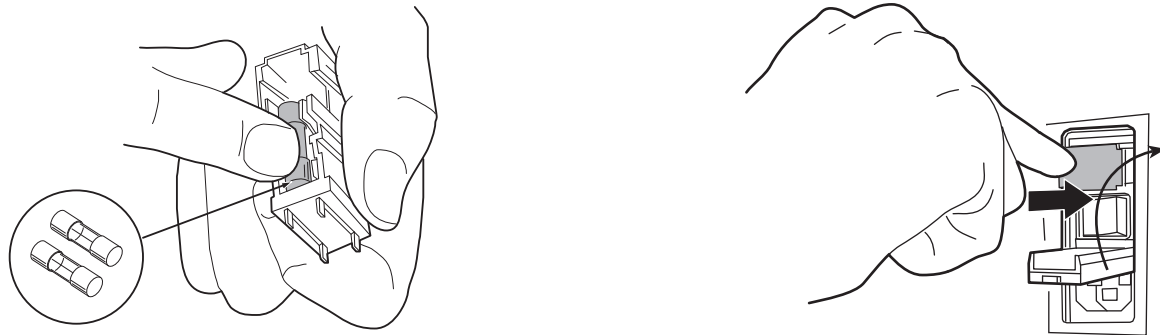

Figure 8-25 Insert new fuses and replace fuse holder

6. Push the fuse holder back into the processor. Push the cover back into position.
7. Reattach the power cord to the processor.
8. Turn the processor power switch on.

If the processor fails to operate, contact Hologic Technical Support.

SECTION F REPLACING THE SLIDE PRINTER

To add or replace the optional slide printer after the original installation of the ThinPrep Genesis processor by Hologic service personnel, remove all of the packaging from the slide printer, including the piece of tape in the slide bin.

Press the cover release button to open the cover. Refer to Figure 1-7 on page 1.15.

Install the printer ribbon. Refer to “Replace the Slide Printer Ribbon” on page 8.21.

Connect the slide printer to the ThinPrep Genesis processor by plugging one end of the USB cable into the slide printer and the other end into the USB connection on the back of the ThinPrep Genesis processor.

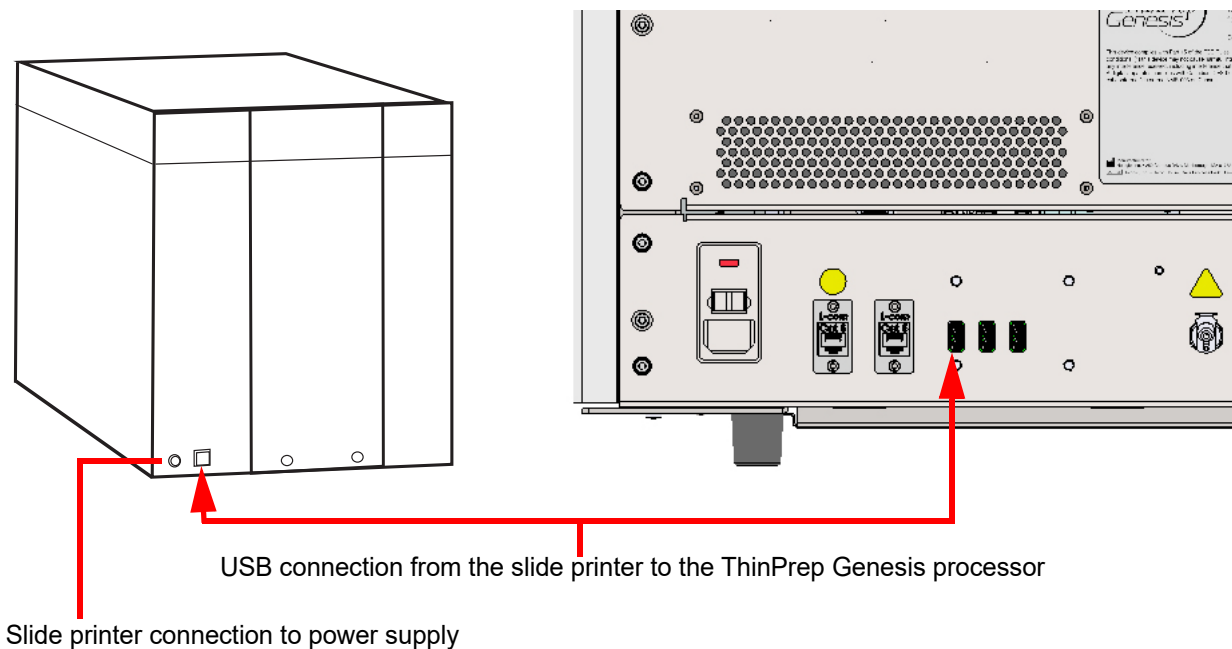

Figure 8-26 Connect the slide printer to the ThinPrep Genesis processor

Plug the power supply into the slide printer and into a wall outlet.

Caution: The power supply for the slide printer is not interchangeable with the power supply for the tube printer. The printers will not function and may be damaged if the wrong power supply is connected.

Press the slide printer power button to turn the slide printer on.

Refer to “Using the Slide Printer” on page 7.15 for information on loading slides into the slide printer.

**SECTION
G**

REPLACING THE TUBE PRINTER

To add or replace the optional tube printer after the original installation of the ThinPrep Genesis processor by Hologic service personnel, remove all of the packaging from the tube printer.

Connect the tube printer to the ThinPrep Genesis processor by plugging one end of the ethernet cable into the tube printer and the other end into the ethernet connection on the back of the ThinPrep Genesis processor.

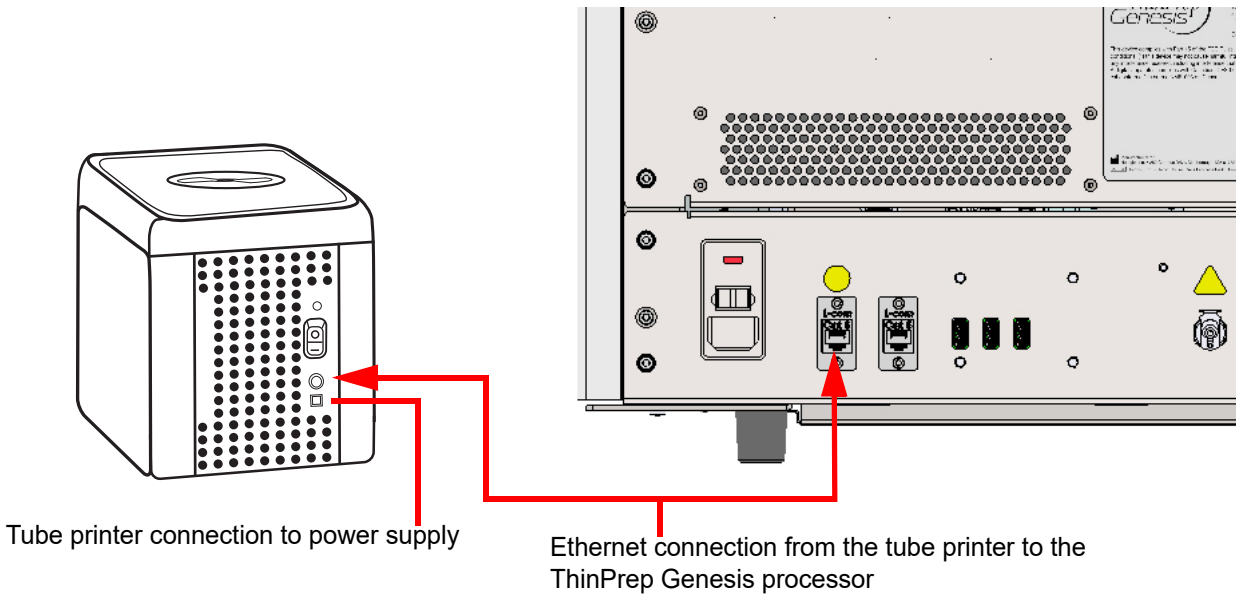

Figure 8-27 Connect the tube printer to the ThinPrep Genesis processor

Plug the power supply into the tube printer and into a wall outlet.

Caution: The power supply for the slide printer is not interchangeable with the power supply for the tube printer. The printers will not function and may be damaged if the wrong power supply is connected.

Press the tube printer power button to turn the tube printer on.

ThinPrep® Genesis Processor Maintenance

Maintenance Schedule for the Month/Year:

Instrument #

	Daily or More				Weekly							As Needed							
	Change Fix Reagent Every 100 Slides or Daily, page 8.3	Slide nest, slide gripper, page 8.3	Disposal cup, page 8.4*	Processing area, page 8.4	Pipettor, page 8.6*	Touch screen, page 8.6	Door and handle, page 8.7	Slide printer print head, page 8.7	Slide printer rollers, page 8.9	Slide printer input roller, page 8.11	Slide printer, page 8.12	Waste bottle, page 8.13	Clear lines 8.18	Absorbent pads, page 8.19	Pipette tip holder, page 8.20	Slide printer ribbon, page 8.21	Slide printer print head, page 8.22	Tube printer print head, page 8.24	Tube printer, page 8.24
1																			
2																			
3																			
4																			
5																			
6																			
7																			
8																			
9																			
10																			
11																			
12																			
13																			
14																			
15																			
16																			
17																			
18																			
19																			
20																			
21																			
22																			
23																			
24																			
25																			
26																			
27																			
28																			
29																			
30																			
31																			

*Maintenance activities related to pipetting are only needed when the Aliquot sequence or the Aliquot + Slide sequence is used.

This page may be photocopied.

Chapter Nine

Troubleshooting

SECTION A

GENERAL

There are three categories of error/status that the system can generate:

- Sample Processing Errors
- User Correctable Errors
- System Errors

This chapter also describes troubleshooting the optional slide printer.

SECTION B

SAMPLE PROCESSING ERRORS

At the conclusion of sample processing sample errors are reported on the vial report. Sample errors occur when a sample vial is being processed. They are “sample specific” and usually only affect the sample vial being processed. If the error does not stop a slide from being made or an aliquot from being removed, the error appears in the processing completion screen and in the vial report. Sample processing errors are not recorded in the error log, only the vial report.

When a sample processing error occurs:

- If a pipette tip has been picked up, it will be disposed of,
- If a filter has been picked up, it will be punctured,
- If a slide has been picked up but not used, it will be returned to the slide nest.



Table 9.1 Sample Processing Errors

Error	Description	Possible Cause	Corrective Action
5000 Tube fluid level too high	The fluid level in the tube is too high for the pipettor to dispense an aliquot from the vial into the tube. The vial will be reported as Failed in the vial report.	The wrong tube, or a tube that already been processed, may have been loaded.	Replace the tube with a new or correct tube and process the sample again.
5001 Tube fluid level too low	The fluid level in the tube is too low for the pipettor to dispense an aliquot from the vial into the tube. The vial will be reported as Failed in the vial report.	The wrong tube, or a tube that already been processed, may have been loaded.	Replace the tube with a new or correct tube and process the sample again.
5002 Vial fluid level too high	When introducing the filter or pipette tip into the vial, the system detects the fluid level too early. (21 ml is the maximum allowed volume.) The sample was not processed. A slide was not made. An aliquot was not removed. The vial will be reported as Failed in the vial report.	There is too much fluid in the vial.	Examine the vial and see if the level of the fluid is above the frosted line on the vial. If it is necessary to reduce the sample volume to between 17 ml and 21 ml, save any excess fluid in an appropriate container. Process the sample again.
5003 Vial fluid level too low	The vial does not contain enough fluid to process properly. (17 ml is the minimum required volume.) The sample was not processed. A slide was not made. If the vial contained sufficient fluid before an aliquot was removed, then the aliquot will be dispensed. The aliquot will be reported as Completed in the vial report. If the vial did not contain sufficient fluid before attempting to remove the aliquot, an aliquot was not removed. The vial will be reported as Failed in the vial report.	The vial leaked. Pneumatic system error. Preparation error resulting in not enough fluid.	Examine the vial to make sure it is not leaking. Place sample into another vial if it is damaged. Check that the fluid level in the sample vial is between 17 ml and 21 ml. Add PreservCyt Solution if the level is below the frosted line on the vial. Do not overfill beyond the frosted line. Process the sample again.
5004 Obstruction in Vial	Filter or pipette tip meets resistance when moving into the vial. The vial will be reported as Failed in the vial report.	Possible object left in vial such as collection device.	Examine the vial to see if there is a foreign object in it. Do not process a vial that has a foreign object in it.
5005 Sample Too Dense	The sample is too dense for the processor to make a satisfactory slide. This message is only a notification; the slide is processed and may be adequate.	The sample is too dense for the processor to make a satisfactory slide.	This is for non-gyn samples only. Shake or vortex sample for 8–12 seconds. Then dilute sample by 20:1. Place 1 ml of sample into a new PreservCyt Solution vial and process again.

Table 9.1 Sample Processing Errors

Error	Description	Possible Cause	Corrective Action
5006 Sample Is Dilute	This error message indicates the entire sample was utilized in preparing the slide. This message is only a notification; the slide is processed and may be adequate.	This message usually indicates a problem with the sample that was collected, rather than an issue with the processor and its mechanisms.	Gyn slides - If the slide is satisfactory for screening purposes, no further action is necessary. If the slide is inadequate, follow laboratory procedure for reporting unsatisfactory specimens. Non-gyn slides - If there is additional sample material available, make another slide with more cells if possible.
5007 Failed to read slide ID	The slide ID could not be read or is an invalid format. The sample was not processed. A slide was not made. An aliquot was not removed. The vial ID will not appear in the vial report.	Slide present with missing or damaged label. Mechanical misalignment or failure of the reader.	Make sure a slide is labeled correctly. Refer to "Adhering Vial Labels" on page 7.8. Check the slide label parameters in the Admin Options settings to see if the slide ID matches the setting on the processor. Refer to "Slide Labels" on page 6.26 and "Configure the slide ID" on page 6.52. Make sure nothing is blocking the slide ID reader (see Figure 8-2). Enter the slide ID again, with the barcode scanner or with the keypad manually. Contact Technical Support if the problem persists.
5008 Slide ID did not match Cytology ID	The slide ID was read and compared to the vial ID. The slide ID did not match the vial ID in the way that is set-up on the processor. The sample was not processed. A slide was not made. An aliquot was not removed. The vial ID will not appear in the vial report.	The wrong ID or barcode was entered. The slide label is in the wrong format. The Admin Options settings are set with a vial/slide labeling scheme that is not correct for your lab.	Make sure the correct slide and vial are used. For vials with more than one ID, make sure the correct ID is entered as a Cytology ID. Check the Label Format parameter in the Admin Options settings to see if it matches the type of slide label being used. Refer to "Slide Labels" on page 6.26 and "Configure the slide ID" on page 6.52. Enter the slide ID again.
5009, 5010 Strand or clog detected during aliquot	The processor attempted to remove an aliquot from the vial and detected a strand in the sample that prevents proper aspiration of the pipette. The sample was not processed. A slide was not made. An aliquot was not removed. The vial will be reported as Failed in the vial report.	The sample has too much material for the pipette to aspirate properly.	Try to process the sample again, with a new pipette tip. If it fails a second time, consider manually pipetting the specimen (not in the processor).

9 TROUBLESHOOTING

SECTION C

MEDIA HANDLING ERRORS

Media handling errors are errors that the system is capable of recovering from with user intervention. The errors occur during the processing of a sample. When the system encounters an error condition, the process halts (terminates, or pauses, depending on the cause) and signals the error via a message on the user interface and by sounding the audible alarm, if it is enabled. Some errors may be detected at the start of processing and need to be resolved before processing can start.

Follow the prompts on the touch screen of the processor to try to resolve the error and continue processing. If the same media handling error occurs after the user intervention, then the processing stops, the error is reported as a System Event, and the processor goes into Restricted Mode. See “Clearing a System Error” on page 9.13.

For some media handling errors, it may be helpful to use the **Clear Media** feature to see and reach a filter, slide, pipette tip, vial, vial cap or tube.

Filter Detection

If the ThinPrep Genesis processor does not detect a new, unpunctured filter at the beginning of the “Slide” or the “Aliquot + Slide” process, a message prompts the user to make sure that a new filter has been loaded. Filter detection can take up to 15 seconds. The buttons on the loading screen are not available during filter detection.

1. Press **Cancel** to stop and check. Open the door either verify that a new filter is correctly loaded or load a new filter onto the filter plug.
2. Press the **Continue** button.

Note: If “Auto-start with Door Close” is enabled, the process starts when the door is closed, and the **Continue** button is not available.

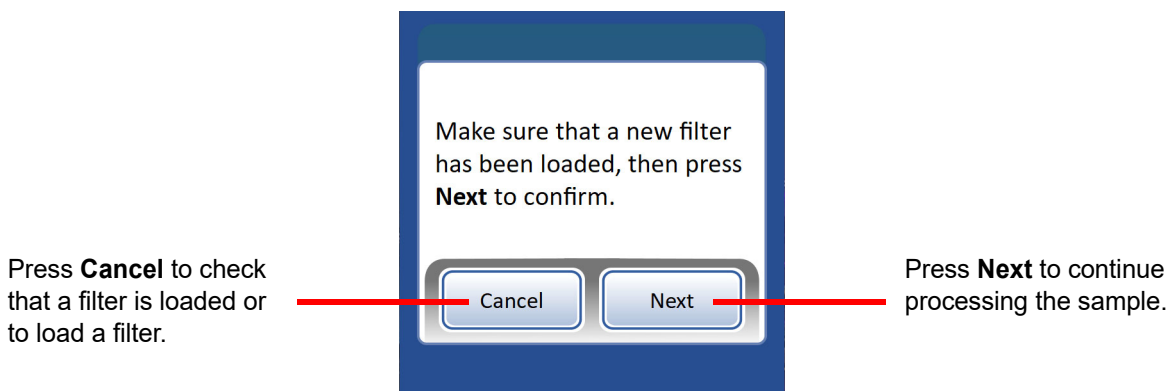

Figure 9-1 Confirm a filter is loaded in the processor

3. If the message appears again when a new, unpunctured filter in place, press **Next** to continue.

Clear Media



Figure 9-2 Clear Media button

For some system errors, it may be necessary to remove a slide, vial cap, filter, tube cap, tube or pipette tip that may have been left in process. From the Main Menu, press **Admin Options**, then **System Maintenance**, and then **Clear Media**. The display provides buttons that will release the holding pressure on those media for removal. See Figure 9-3.

Note: The media will drop as soon as the pressure is released. Hold the item before pressing the button so it won't fall.

Release: Slide will open the slide gripper fingers to let go of the slide.

Release: Vial Cap will open the fingers of the vial cap gripper to drop the vial cap.

Release: Filter vents the filter plug, so that the filter may be pulled off. For some errors, this may first appear as a **Drain** button.

Release: Tube Cap will open the fingers of the tube cap gripper to drop the tube cap. In this example, the Tube Cap has already been released.

Release: Tube will open the gripper in the tube holder so that the tube can be removed.

Release: Pipette Tip releases the pressure on the pipettor to eject the pipette tip. For some errors, this may first appear as a **Drain** button.

Press **Done** to return to the System Maintenance screen.

Press **Reposition Robot** to move the robot using your hand.

Clear Lines sends air through the pneumatic tubing connected to the filter plug as an instrument maintenance activity. The **Clear Lines** button is not shown when the **Clear Media** screen is the result of an error.

Figure 9-3 Clear Media screen

Because the robot moves up and down and rotates during processing, depending on when the error occurred, the media left in the processor may be difficult to see or to reach. Use the **Reposition Robot**

9 TROUBLESHOOTING

button to gently lower, lift or rotate the robot by hand. The grey handle to the right of the robot can help reposition the robot, especially if it stopped in a very low position.

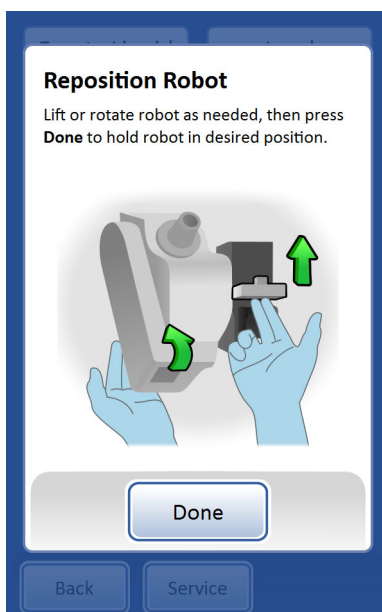

After pressing the **Reposition Robot** button, gently push the robot to rotate, lift, or lower it. The robot rotates both clockwise and counterclockwise.

Press **Done** on this screen to hold the robot in its new position. Remove any media.

Figure 9-4 Reposition robot

Note: There is one special case. If an error occurs while the pipette tip is immersed in the vial, it will be impossible to use the Reposition robot feature because the pipettor is pointed towards an open vial without adequate clearance to move the pipettor (error 6061, see Figure 9-5). In this case, shut the processor down, and, when power to the processor is off, move the robot up. Turn the processor on. The **Reposition robot** button will only be available after the pipettor is pointed away from the vial.

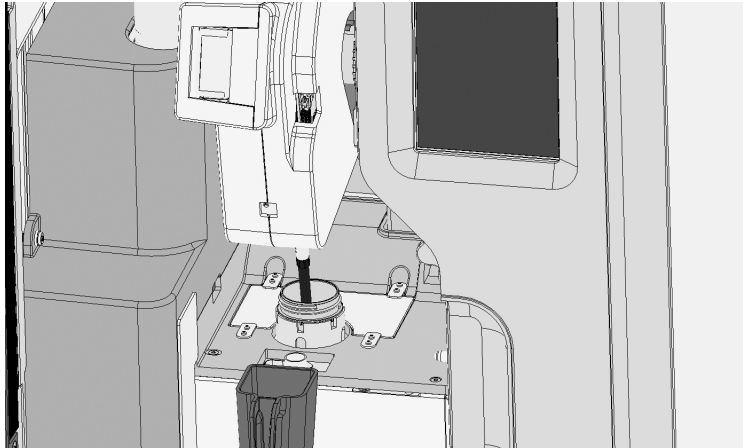
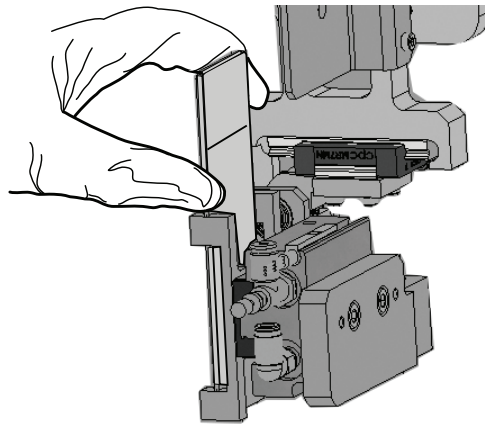

Figure 9-5 Move pipettor to avoid vial

Release slide

Note: Locate the slide before pressing the release button.

A slide might be located in the slide gripper of the slide transport arm. The slide grippers remain closed after picking a slide until it has been handed off to the fixative bath or returned to the slide nest. To release the slide from the gripper, hold the slide so that it will not fall, and press the **Release: Slide** button.



Hold a slide remaining in the slide grippers. Press **Release: Slide** and the grippers release the hold on the slide.

Figure 9-6 Release slide

Release vial cap

The vial cap gripper fingers remain closed in an error condition, so that a vial cap will not drop. Hold the vial cap and then press the **Release: Vial Cap** button to open the gripper and remove the vial cap. See Figure 9-7.

9

TROUBLESHOOTING

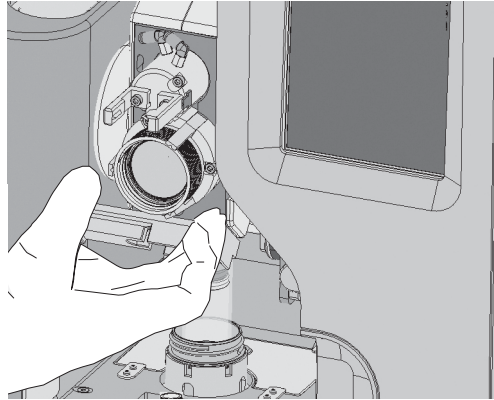

Figure 9-7 Release vial cap

Note: If the vial cap is not in the gripper, the vial cap may have dropped to the floor of the processing area. If so, retrieve the cap and manually recap the vial.

Release filter

The filter plug keeps a slight pressure in the filter once it has been picked, to keep it from dropping. To remove a filter that is left on the filter plug, press the **Release: Filter** button. Then gently pull the filter off.

If the error occurred while the filter has fluid in it, rotate the robot so that the filter is above the uncapped vial. With the filter in position, hold the filter and press the **Drain** button on the Clear Media screen. Pour the fluid from the filter into the vial below.

Caution: Never forcibly remove a filter from the filter plug without releasing the system pressure. Damage to the processor could occur.

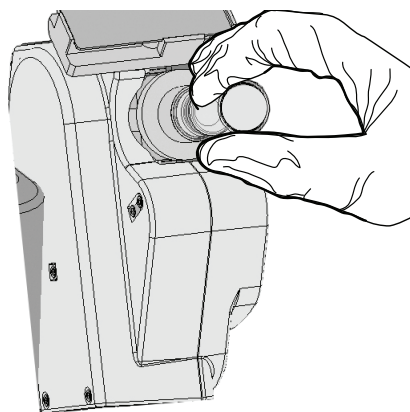

Figure 9-8 Release filter

Release tube cap

The tube cap gripper fingers remain closed in an error condition, so that a tube cap will not drop. Hold the tube cap and then press the **Release: Tube Cap** button to open the gripper and remove the tube cap. See Figure 9-9.

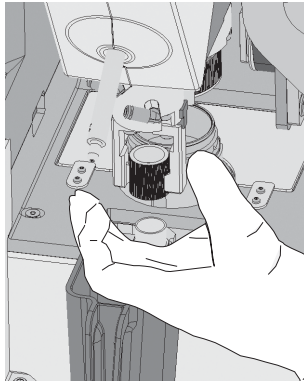

Figure 9-9 Release tube cap

Release tube

The tube gripper in the tube holder remains closed in an error condition, so that a tube will remain still. Hold the tube and then press the **Release: Tube** button to open the gripper and remove the tube. See Figure 9-10.

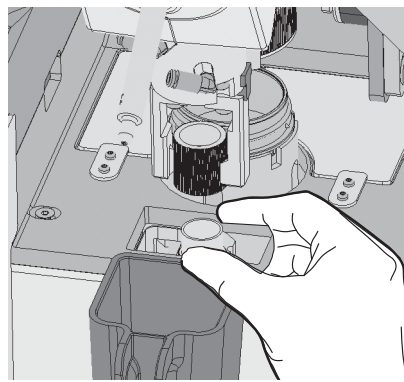

Figure 9-10 Release tube

Release pipette tip

The pipettor keeps a slight pressure in the pipette tip once it has been picked, to keep it from dropping.

If the error occurred while the pipette tip has fluid in it, rotate the robot so that the pipette tip is above the uncapped vial. With the pipette tip in position, hold the pipette tip and press the **Drain** button on the Clear Media screen. Pour the fluid from the pipette tip into the vial below.

9 TROUBLESHOOTING

To remove a pipette tip that is left on the pipettor, hold the pipette tip and press the **Release: Pipette Tip** button. Then processor will retract the end of the pipettor to eject the pipette tip.

Caution: Never forcibly remove a pipette tip from the pipettor without releasing the system pressure, as damage to the processor could occur.

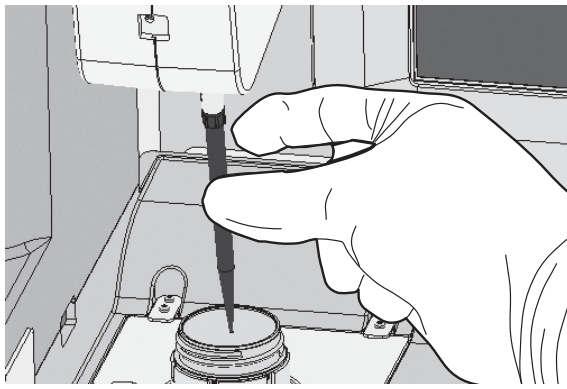

Figure 9-11 Release pipette tip

Clear lines

The **Clear Lines** button sends air through the pneumatic tubing connected to the filter plug, moving any moisture droplets that may be in the tubing. This is described in Chapter 8, "Maintenance".

Table 9.2 Media Handling Errors

Error	Description	Possible Cause	Corrective Action
6100, 6102, 6103 Vial handling error	The processor did not properly spin, uncap, or recap the vial.	Obstruction in the path of the dispersion mechanism or robot. Damaged vial cap. Damaged vial gripper. Processor malfunction.	Remove any obstruction. Inspect the vial cap. If the error is not resolved, contact Technical Support.
6101 Failed to tighten vial cap	The processor did not tighten the vial cap properly.	Damaged vial cap. Damaged vial gripper. Processor malfunction.	Inspect the vial cap. If the error is not resolved, contact Technical Support.
6103 Failed to uncap vial	The processor did not completely remove the vial cap.	Physical interference with cap removal. Damaged vial cap. Damaged vial gripper. Processor malfunction.	Examine the vials to see if there is any evident reason for uncap to fail (such as the plastic over wrap was not removed from the vial). Loosen and retighten the cap and process again. Inspect the vial cap. If the error is not resolved, contact Technical Support.
6150, 6152, 6153 Slide handling error	The processor failed to transfer an unused slide between the slide nest and the slide gripper or failed to move the robot properly to handle an unused slide.	Damaged slide. WARNING: Glass Use caution when handling glass slides. Obstruction at the slide nest. Slide gripper malfunction.	Inspect the unused slide for damage and replace the slide if it is damaged. Wipe any glass dust and debris from the slide nest and the slide grippers. If the error is not resolved, contact Technical Support.
6151 Slide not present in grippers	The processor failed to detect a slide in the slide grippers.	Damaged slide. Slide not properly placed in the slide nest. Sensor malfunction.	Inspect the unused slide for damage and replace the slide if it is damaged. Wipe any glass dust and debris from the slide nest and the slide grippers. If the error is not resolved, contact Technical Support.
6154 Unexpected slide or filter present	A slide or filter was loaded in the processor and "Aliquot" was selected as the item to process. Slides and filters are not used in the aliquot process.	A slide or a filter was inadvertently left in the processor at the beginning of the aliquot process.	Remove the slide or filter and begin processing the aliquot.
6200, 6201, 6202, 6204, 6205, 6206 Filter handling error	The processor failed to move the filter on the filter plug, failed to detect the filter, or failed to position the filter for blowing liquid sample from the filter back into the vial.	Filter plug malfunction. Malfunction in the pneumatics system. Failure of the processor to properly position the filter.	Use the Clear Media feature to drain and/or remove the filter. If the error is not resolved, contact Technical Support.
6203 Filter used or not present	The processor attempted to detect the presence of a filter and did not detect an intact filter.	Filter missing from the filter plug. Filter on the filter plug is a damaged filter or punctured filter. Error with the filter detection.	Load a new filter onto the filter plug. If the error is not resolved, contact Technical Support.

Table 9.2 Media Handling Errors

Error	Description	Possible Cause	Corrective Action
6207 Failed to prepare to clear lines	The processor failed to move the robot to the correct position to clear the lines.	Obstruction of the robot.	Check that there is nothing blocking the robot. Check for a dropped tube cap or vial cap that could impede normal movement. Remove the obstruction. Process the sample again. If the error is not resolved, contact Technical Support.
6208 Error while clearing lines	The processor failed to clear the lines because of a pneumatic system error.	Malfunction in the pneumatics system.	Attempt the Clear Lines process again. If the error is not resolved, contact Technical Support.
6250, 6251, 6252 Tube handling error	The processor failed to properly grasp and release the tube or the tube cap during processing.	Tube removed during processing. Tube cap dropped or damaged Mechanical failure prevented uncapping of the tube or the gripping of the tube	Check for a dropped tube cap or vial cap that could impede normal movement. If the error is not resolved, contact Technical Support.
6300, 6301, 6203, 6304, 6305, 6306, 6307, 6309, 6310, 6311 Pipette handling error	The processor failed to move the robot, failed to move the pipette tip holder, failed to pick up pipette tips from the pipette tip holder, or failed to release a used pipette tip into the pipette tip disposal cup.	Obstruction of the robot, the pipette tip storage area, the vial or the pipette tip disposal cup. Pipette tip is damaged. Processor malfunction	Check that there is nothing blocking the robot or the pipette tip storage area. Check that the pipette tips are seated firmly in the pipette tip holder. Examine the vial to see if there is a foreign object in it. Remove the obstruction. Examine the pipette tip disposal cup to see if there is a foreign object in it. Remove the obstruction. Process the sample again. If the error is not resolved, contact Technical Support.
6308 No pipette tips detected	The processor failed to detect any pipette tips in the pipette tip holder.	The pipette tip holder is out of pipette tips. The pipette tip holder was removed from the processor. Sensor error.	Replenish the pipette tips in the pipette tip holder. Return the pipette tip holder to the processor. (Refer to "Load the Pipette Tips" on page 7.19) If the error is not resolved, contact Technical Support.

SECTION
D

SYSTEM ERRORS

System errors are errors that the ThinPrep Genesis processor is not capable of recovering from without user intervention. The current process terminates and the system attempts to report the error. A system error is an error that will most likely require field service assistance. A user may choose or be instructed to restart the system. The error is reported to the error log.

Clearing a System Error

When a system error has been detected, the system will usually:

- Move mechanisms out of the way, unlock the door and return to an idle state.
- Display the error message and sound the audible alarm, if enabled (see Figure 9-12.) The system attempts to recover (a minute or less).

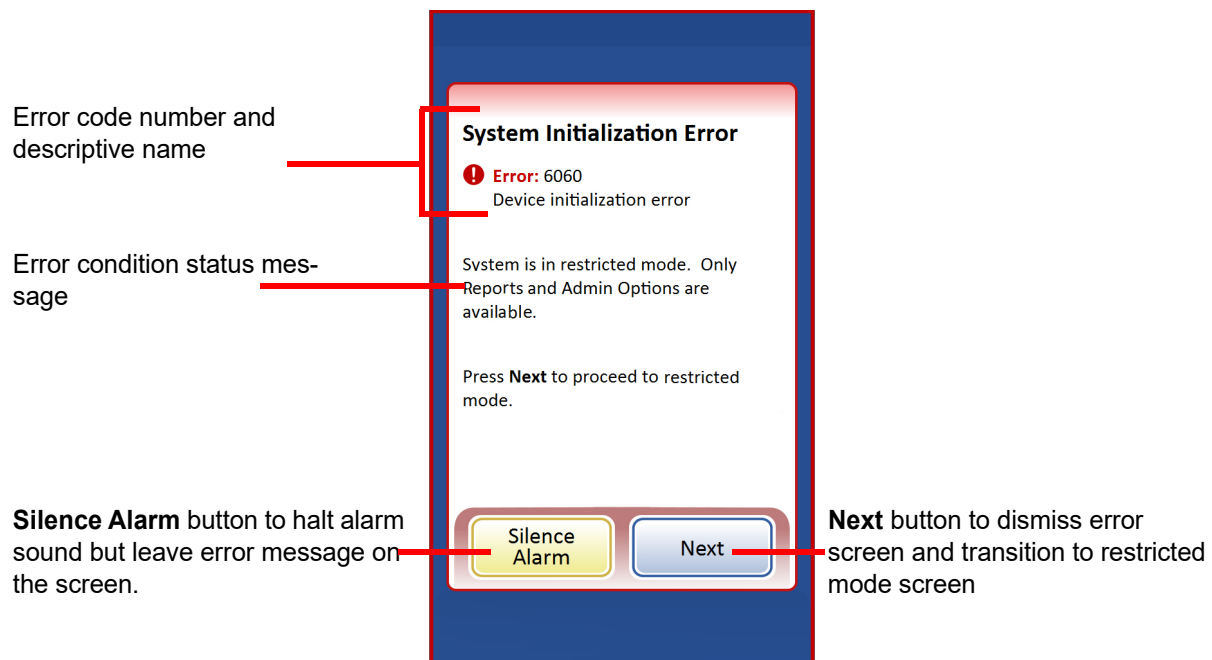

Figure 9-12 System detected an error

If the system cannot recover, it attempts to move the mechanisms out of the way, turns off the robot motors so the operator can easily move a slide, filter, pipette tip, tube or vial. The door unlocks for user access.

Restricted Mode

If the processor cannot fully recover from an error condition, the application will transition to restricted mode. This allows the operator to access some functions, but the system cannot process samples until the error is resolved. After acknowledging the error message, the user interface displays the **Main Menu**. The **Reports** button is available, where you can review or download the System Events report (which will have captured the error code). From the Reports screen, you can also use the **Gather Diagnostics** button when requested by Technical Support. The **Admin Options** access button is available, and from Admin Options, the **Shutdown** button is available, in order to restart the processor, which usually clears a system error.



Figure 9-13 Restricted mode, Main Menu screen

To recover from an error requiring shutdown, press the **Shutdown** button.

Wait for the computer to turn off (wait until the touch screen interface goes blank). Then turn off the power switch on the back of the processor. After a few seconds of the power being fully off, turn the processor on again and let it boot up. The main screen should be displayed when the system is ready to process.

If the restricted mode screen appears after restarting, contact Technical Support. Hologic Technical Support may ask for a Gather Diagnostics report. Refer to “Gather diagnostics” on page 6.65.

Slide Jam in the Slide Printer

If the slide printer jams, press the slide eject button to attempt to eject the slide.

If the slide printer has not advanced the slide out of the slide cartridge, remove the slide cartridge. With gloved hands, open the slide cartridge and separate any slides that are stuck to each other. If the slide cartridge is full or nearly full of slides, remove slides so that the slide cartridge is approximately one-third full. Close the slide cartridge, return the slide cartridge to the slide printer, and press the slide eject button.

If the jammed slide is still in the printer but not in the slide cartridge, open the cover of the slide printer and remove the slide printer ribbon. Remove the slide cartridge. Check the cartridge area for a slide. Check under the slide printer ribbon for a slide.

With the cover open, reverse the motion of the slide rollers by pressing and holding the power button. Remove the slide when it is easy to reach. Pressing the slide eject button may also bring a slide to a position that is easy to reach.

Keep the input roller on the slide printer clean to avoid jammed slides. Refer to “Clean the Input Roller on the Slide Printer” on page 8.11.

If there is a broken slide in the slide printer that cannot be removed as described above, debris from the slide may fall into the metal tray at the bottom of the slide printer. Slide the metal tray to the left or to the right to remove the tray. Remove any debris. Slide the tray back into position. The hole in the tab on the tray aligns with the screw on the left side of the printer. Make sure the hole and the screw are lined up to lock the tray in place.

Broken Slide Printer Ribbon

If the ribbon in the slide printer breaks, it can be reconnected from the supply ribbon roll to the take-up roll using a piece of adhesive tape.

Open the cover of the slide printer. Turn the supply ribbon roll so that the ribbon comes up over the top of the supply ribbon roll. Attach a piece of tape to the end of the ribbon, sticky side down.

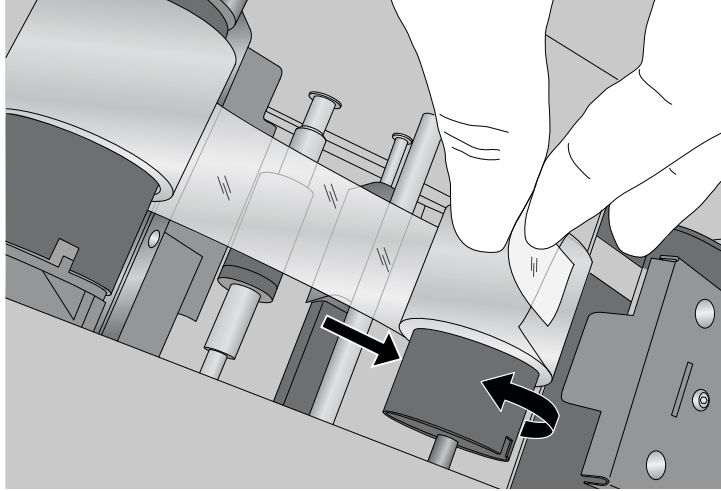

Figure 9-14 Repair a broken ribbon in the slide printer

Feed the supply ribbon under the take-up roll. Stick the tape to the take-up roll. Turn the take-up roll until the ribbon is taut. Close the printer cover.

If the ribbon breaks again it could indicate a problem with the slide printer. Contact Hologic Technical Support.

Slide Printer Ribbon not Recognized/Slide Printer Cartridge not Recognized

If the slide cartridge is installed in the slide printer and the slide ribbon is installed in the slide printer, but the blue light does not illuminate the slide cartridge and the printer will not print, check that the slide printer ribbon is the ribbon available from Hologic. The wrong ribbon will not work.

If it is the correct ribbon, either the copper chip on the blue supply roll of the ribbon or the copper chip on the slide cartridge may be too dirty for the slide printer to recognize it. Remove the ribbon and slide cartridge from the slide printer. Wipe the copper chip on the blue portion of the ribbon supply roll with a lint-free cloth moistened with isopropyl alcohol. Wipe the copper chip on the slide cartridge with a lint-free cloth moistened with isopropyl alcohol.

If the error is not resolved, contact Technical Support.

Error Codes

An error has a two-part error code associated with it. The first four digits represent the error category and the following characters represent the status of the particular electromechanical device at the time the fault occurred. See Figure 9-15.

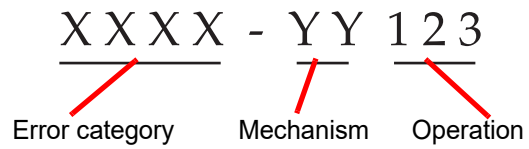

Figure 9-15 System error code

The error codes will be logged in the Error History report. The report displays the last 100 errors, but keeps up to 3 years' worth in the system database.

In most cases, the Clear Media dialog box will display. Check that the mechanisms are clear and begin a new batch.

If an error is not resolved, contact Technical Support.

The logo for section 9, 'TROUBLESHOOTING', features a large blue number '9' centered within a circular arc. The arc is multi-colored, transitioning from yellow at the top to orange, then red, and finally purple at the bottom. To the right of the circle, the word 'TROUBLESHOOTING' is written in a dark blue, uppercase, sans-serif font.

9 TROUBLESHOOTING

This page intentionally left blank.

10. Fixation, Staining and Coverslipping

10. Fixation, Staining and Coverslipping

Chapter Ten

Fixation, Staining, and Coverslipping

SECTION A

INTRODUCTION

Following is a description of these *recommended guidelines* for fixation procedures, staining protocols, and coverslipping methods.

Note: There is wide variation among laboratories in fixation, staining, and coverslipping methods employed for cytologic specimens. The thin layer characteristics of ThinPrep® processor prepared slides allow precise assessment of the effects of these differences in protocols and allows the laboratory personnel to optimize their methods by following the general guidelines provided in this section. These guidelines are recommendations and should not be considered absolute requirements.

10

FIXATION, STAINING, AND COVERSIPPING

SECTION B

FIXATION

The ThinPrep Genesis processor deposits completed slides into a fixative bath that contains 95% reagent alcohol or 95% ethyl alcohol. Use the following procedure to fix ThinPrep microscope slide preparations.

1. Remove each slide after it is deposited into the fixative bath in the ThinPrep Genesis processor.
2. Place the slide in a multi-slide holder and place the slide holder into a fixative bath containing 95% reagent alcohol or 95% ethyl alcohol. In order to minimize exposure of ThinPrep microscope slides to air:
 - When transferring ThinPrep microscope slides from the fixative bath to the multi-slide fixative container, care should be taken to perform this operation quickly.
 - If ThinPrep microscope slides are being transferred to a staining rack, care should be taken that ThinPrep slides are continuously immersed in fixative.
3. **Gyn slides:** ThinPrep microscope slides should be fixed for at least 10 minutes prior to staining.

Non-Gyn slides: ThinPrep microscope slides should be fixed for at least 10 minutes prior to staining or application of fixative spray.

Note: Some non-gyn slides will drop into a dry bath or PreservCyt Solution, depending on the type being run.

For Gyn slides intended for use with the ThinPrep® Imaging System: ThinPrep microscope slides should be fixed for at least 10 minutes prior to staining.

SECTION
C

STAINING

General guidelines to consider when staining ThinPrep slides are:

- Staining times may be different and may require adjustment for ThinPrep slides compared to conventional preparations.
- The use of graded concentrations of alcohol in the staining process will minimize cell distortion and possible cell shedding.
- The use of mild bluing solutions and dilute acid baths will optimize nuclear staining and minimize possible cell shedding.

Staining Protocol:

A recommended staining protocol for ThinPrep slides is attached. This protocol incorporates the general staining guidelines stated above and the following specific recommendations:

1. If slides have been spray fixed, remove the spray fixative by soaking in a standard laboratory fixative for at least 10 minutes.
2. Stain the ThinPrep slides with standard modified Papanicolaou stains according to the manufacturer's routine procedures adjusting to the general guidelines for ThinPrep slide staining stated above.
3. Standard staining times for ThinPrep slides may be different from conventional slides, and it may be necessary to increase or decrease these times. It is recommended that staining times be optimized following laboratory standard operating procedures. These differences may necessitate staining ThinPrep and conventional slides separately.

4. Hologic recommends minimizing exposure of slides to strong acidic or strong basic solutions since this may result in possible cell shedding. Below are recommended maximum concentrations of some solutions:
 - Hydrochloric acid (HCl) 0.025%
 - Lithium Carbonate (bluing) baths 10mg per liter¹
 - Acetic acid 0.1%
 - Ammonium Hydroxide 0.1%
5. Avoid the use of strong salt solutions like Scotts Tap Water Substitute. Hologic recommends the use of a dilute Lithium Carbonate solution or Ammonium Hydroxide solution as the bluing solution.
6. During the hydration dehydration process, use graded concentrations e.g., 50%, 70% of alcohol. This lowers the potential of osmotic shock and possible cell shedding during staining.
7. Bath solution heights should be sufficient to completely cover the slides during the entire staining cycle to reduce the possibility of shedding cells.
8. Slides should be agitated for at least 10 dips in each bath.

For Gyn slides intended for use with the ThinPrep Imaging System, consult recommended staining protocols found in the ThinPrep Stain User's Manual.

Table 10.1 Hologic Recommended Staining Protocol

	Solution	Time
1.	70% Reagent Alcohol	1 minute with agitation
2.	50% Reagent Alcohol	1 minute with agitation
3.	Distilled H ₂ O (dH ₂ O)	1 minute with agitation
4.	Richard-Allan Hematoxylin I	30 seconds with agitation*
5.	Distilled H ₂ O (dH ₂ O)	15 seconds with agitation
6.	Distilled H ₂ O (dH ₂ O)	15 seconds with agitation
7.	Clarifier (0.025% glacial acetic acid)	30 seconds with agitation
8.	Distilled H ₂ O (dH ₂ O)	30 seconds with agitation

1. Refer to Bales, CE. and Durfee, GR. *Cytologic Techniques* in Koss, L, ed. *Diagnostic Cytology and its Histopathologic Basis*. 3rd Edition. Philadelphia: JB Lippincott. Vol. II: pp 1187–1260 for details

	Solution	Time
9.	Bluing Reagent (10mg LiCarb/1L)	30 seconds with agitation
10.	50% Reagent Alcohol	30 seconds with agitation
11.	95% Reagent Alcohol	30 seconds with agitation
12.	Richard-Allan Scientific™ Cyto-Stain™	1 minute with agitation
13.	95% Reagent Alcohol	30 seconds with agitation
14.	95% Reagent Alcohol	30 seconds with agitation
15.	100% Reagent Alcohol	30 seconds with agitation
16.	100% Reagent Alcohol	30 seconds with agitation
17.	100% Reagent Alcohol	30 seconds with agitation
18.	Xylene	1 minute with agitation
19.	Xylene	1 minute with agitation
20.	Xylene	3 minutes with agitation
21.	Coverslip slides	

* Time may vary with laboratory preference.

10

FIXATION, STAINING, AND COVERSIPPING

SECTION D

COVERSLIPPING

Each laboratory should evaluate their choice of mounting media to insure compatibility with ThinPrep slides.

Hologic recommends the use of 24 mm x 40 mm or 24 mm x 50 mm coverslips.

Plastic coverslip material used with automated coverslipping instrumentation is also acceptable.

If you are staining and coverslipping for ThinPrep Imaging System slides, please see the Image Processor Operator's Manual first.

Chapter Eleven

ThinPrep Pap Test Training Program

Objective

The ThinPrep® Pap Test Training Program was developed by Hologic to assist laboratories in the conversion process from the conventional Pap smear to the ThinPrep Pap test. Hologic offers information, support and training for the conversion process, including communicating the change to the clinician, cytopreparatory training, ThinPrep Pap test morphology training program and guidelines to assist with training the entire cytology staff in the laboratory.

Design

Morphology Training is designed to communicate the differences between the conventional Pap smear and the ThinPrep Pap test. The participants use a series of slide modules to familiarize themselves with a spectrum of normal and abnormal cytological entities on ThinPrep Pap test samples.

This program is based on a cumulative learning process. Interpreting the morphologic criteria of ThinPrep Pap test samples requires review and application of cytology skills and knowledge. A systematic approach allows for frequent assessment of an individual's understanding of the ThinPrep characteristics. The training program incorporates both pre- and post-tests in order to assess learning progress.

The training begins with the ThinPrep morphology lecture, which is designed to familiarize the participants with the microscopic presentation of cervical samples prepared using the ThinPrep System. The format summarizes the morphologic features common to specific diagnostic entities described in *The Bethesda System for Reporting Cervical Cytology*¹.

Following the introductory lecture, a module of known ThinPrep Pap test cases are reviewed by all participants. This module presents a wide variety of diseases and disease states and provides the participant a base reference for the full range of diagnostic categories to be encountered. Review of "look-alike" cases is also included. Through the use of the ThinPrep Gyn Morphology Atlas, which highlights common diagnostic entities and their differential diagnoses, participants will begin to recognize key look-alike entities on ThinPrep slides and the criteria that can be used in their proper classification.

A series of modules of unknown ThinPrep Pap test cases is used to assess the ThinPrep screening and interpretive skills of each participant. Participants are required to screen and diagnose each set

1. Nayar R, Wilbur DC. (eds). *The Bethesda System for Reporting Cervical Cytology: Definitions, Criteria, and Explanatory Notes*. 3rd ed. Cham, Switzerland: Springer: 2015.



THINPREP PAP TEST TRAINING PROGRAM

of cases and record their results on the provided answer sheet. Once complete, the cases and correct responses are reviewed individually by each participant.

A final set of unknown ThinPrep Pap test slides is provided. This final set of slides is modeled after current CLIA guidelines and will be scored by Hologic-designated personnel. Successful completion of these slides is necessary to receive a certificate of completion.

CLIA Proficiency Test Program standards are used as guidelines in establishing pass/fail scoring criteria. Individuals receiving a 90% or better on the Final Assessment are qualified to screen/interpret ThinPrep Pap test cases, and to begin training additional cytotechnologists and pathologists in their laboratory under the supervision of the laboratory Technical Supervisor, if needed.

Participants of the training program receiving less than 90% on the Final Assessment would require remedial training in their individual laboratories. This training involves the screening/diagnosing of an additional ThinPrep Pap test slide module provided by Hologic and requires a score of 90% or better to complete Hologic's ThinPrep Pap test Training Program.

Cytology Staff Training

Hologic supports cytology staff training by providing information and resources, such as slides, answer sheets, and online educational material, for use by the lab in training additional staff. The laboratory Technical Supervisor is ultimately responsible for ensuring adequate training for individuals prior to screening and interpreting ThinPrep Pap test cases.

Bibliography

Nayar R, Wilbur DC. (eds). *The Bethesda System for Reporting Cervical Cytology: Definitions, Criteria, and Explanatory Notes*. 3rd ed. Cham, Switzerland: Springer: 2015.

Service Information

Service Information



Service Information

Mailing Address

Hologic, Inc., 250 Campus Drive, Marlborough, MA 01752 USA

Remittance Address

Hologic, Inc., P.O. Box 3009, Boston, MA 02241-3009 USA

Business Hours

Hologic's business hours are 8:30 a.m. to 5:30 p.m. EST Monday through Friday excluding holidays.

Customer Service

To order products, and place or amend standing orders, call Customer Service at 1-800-442-9892 or 1-508-263-2900 during business hours or fax your order to the attention of Customer Service at 1-508-229-2795.

To order service contracts call Technical Support at 1-800-442-9892 or 1-508-263-2900 during business hours.

Technical Support

Technical service and cytology application representatives are available to answer questions about your ThinPrep® Genesis processor and related application issues at 1-800-442-9892 or 1-508-263-2900 from 7:00 a.m. to 7:00 p.m. Eastern Time Monday through Friday excluding company holidays.

Returns

For returns related to warranty issues, please contact Technical Support at 1-800-442-9892 or 1-508-263-2900 and for questions regarding any other type of return, please contact Customer Service.



SERVICE INFORMATION

This page intentionally left blank.

Ordering Information

Ordering Information



Ordering Information

Mailing Address

Hologic, Inc., 250 Campus Drive, Marlborough, MA 01752 USA

Remittance Address

Hologic, Inc., P.O. Box 3009, Boston, MA 02241-3009 USA

Business Hours

Hologic's business hours are 8:30 a.m. to 5:30 p.m. EST Monday through Friday excluding holidays.

Ordering Information

To order products, and place or amend standing orders, call Customer Service at 1-800-442-9892 or 1-508-263-2900 during business hours or fax your order to the attention of Customer Service at 1-508-229-2795.

To order service contracts call Technical Support at 1-800-442-9892 or 1-508-263-2900 during business hours.

Terms

Net 30 days.

Shipping

All prices are F.O.B. Marlborough, Massachusetts, USA. All in-stock items are shipped on the next business day after the order is placed via UPS ground delivery. Second day and overnight delivery are available upon request.

PreservCyt[®] Solution and CytoLyt[®] Solution are considered hazardous substances and air freight companies will not guarantee second day or overnight delivery. Please try to order your solutions in advance.

Technical Support

Technical service and cytology application representatives are available to answer questions about your ThinPrep[®] Genesis[™] processor and related application issues at 1-800-442-9892 or 1-508-263-2900 from 8:30 a.m. to 5:30 p.m. Eastern Time Monday through Friday excluding company holidays.

Returns

Hologic does not accept returns for the following products: PreservCyt Solution and CytoLyt Solution. All non-returnable items are guaranteed to ship from Hologic, Marlborough, Massachusetts at least six months prior to the expiration date on the product.



ORDERING INFORMATION

For returns on all other supplies, please call Customer Service at 1-800-442-9892 or 1-508-263-2900 to obtain a Return Goods Authorization number. Hologic will not accept any returned items without this number.

For returns related to warranty issues, please contact Technical Support at 1-800-442-9892 or 1-508-263-2900 and for questions regarding any other type of return, please contact Customer Service.

Supplies for the ThinPrep® Pap Test (Gynecologic) Application

Item	Description	Order Number
ThinPrep Pap Test kit	Materials for 500 ThinPrep Pap Tests Contains: 500 Vials of PreservCyt Solution for use with the ThinPrep Pap Test 500 ThinPrep Pap Test Filters (Clear) 500 ThinPrep Microscope Slides (approximately 500 slides) 500 Collection Devices Configured with: 500 Broom-like Collection Devices 500 Cytobrush/Spatula Collection Devices	 70096-001 70096-003
ThinPrep Pap Test Kit (for use with the ThinPrep Imaging System)	Materials for 500 ThinPrep Pap Tests Contains: 500 Vials of PreservCyt Solution for use with the ThinPrep Pap Test 500 ThinPrep Pap Test Filters (Clear) 500 ThinPrep Imaging System Microscope Slides (approximately 500 slides) 500 Collection Devices Configured with: 500 Broom-like Collection Devices 500 Cytobrush/Spatula Collection Devices	 70662-001 70662-003

ORDERING INFORMATION



Item	Description	Order Number
ThinPrep Pap Test Physician Office Kit	Contains: 500 Vials of PreservCyt Solution for GYN	
	Configured with: 500 Broom-like Collection Devices	70136-001
	500 Cytobrush/Spatula Collection Devices	70136-002
ThinPrep Pap Test Laboratory Kit	Contains: 500 ThinPrep Pap Test Filters (Clear)	
	500 ThinPrep Microscope Slides (approximately 500 slides)	70137-001
ThinPrep Pap Test Laboratory Kit (for use with the ThinPrep Imaging System)	Contains: 500 ThinPrep Pap Test Filters (Clear)	
	500 ThinPrep Imaging System Microscope Slides (approximately 500 slides)	70664-001
Broom-Like Collection Devices Kit	Contains: 500 Broom-like Collection Devices (20 bags of 25 devices)	70101-001
Cytobrush/Plastic Spatula Kit	Contains: 500 Cytobrush/Spatula Collection Devices (20 bags of 25 device pairs)	70124-001



ORDERING INFORMATION

Supplies for the ThinPrep Genesis Processor

Item	Description	Order Number
Waste Filter	1	50248-001
ThinPrep Genesis Processor Operator's Manual	1	MAN-05394-003
Waste Bottle Assembly (includes: cap, tubing, filter & connectors)	1	74002-004
Waste Tubing Replacement Kit	2 Pre-cut tubes for waste tubing replacement	70028-001
Fixative Baths	1 bath	ASY-11451
Tube printer	1	ASY-11355
Slide printer	1	ASY-11389
Replacement ribbon for the slide printer	Package of 6	OEM-01378
Cleaning pen for the print head on the slide printer	5 pens	OEM-01388
Polishing paper for the print head on the slide printer	1 sheet	OEM-01389
Replacement print head for the slide printer	Package of 1	OEM-01726
Replacement slide cartridge for the slide printer	Package of 1	OEM-01376
Eppendorf 8-channel pipette tip gripper	1	ASY-12936
Multi-Mix [®] Racked Vortexor	1	*
Absorbent pad, filter plug	Package of 4	FAB-14505
Absorbent pad, filter puncture	Package of 4	FAB-14626
Pipette tip disposal cup	1	FAB-14312
Pipette tip holder	1	FAB-12390
10A/250V fuses	Replacement fuses	CKB-00112

* Order number depends upon specific power requirements for each country. Contact Hologic Customer Service.



Supplies and Solutions for Non-Gynecologic Applications

Item	Description	Order Number
PreservCyt Solution	20 ml in a 2 oz. vial 100 vials/box	ASY-14756
	946 ml in a 32 oz. bottle 4 bottles/box	0234004
Cytolyt Solution	946 ml in a 32 oz. bottle 4 bottles/box	0236004
	30 ml in a 50 ml centrifuge tube 80 tubes/box	ASY-15208
	30 ml in a 120 ml cup 50 cups/box	ASY-15207
Dispenser Pump	1 Pump for CytoLyt Quart (32 oz.) Bottle Dispenses approximately 30 ml.	50705-001
Non-Gyn Filters (Blue)	Box of 100	70205-001
ThinPrep UroCyte [®] System Kit	100 ThinPrep UroCyte Filters (Yellow) 100 UroCyte microscope slides (approximately 100 slides) 1 PreservCyt Vial 100-pack 4 bottles of CytoLyt Solution (946 ml in a 32 oz. bottle)	71003-001
ThinPrep UroCyte Filters (Yellow)	100 filters per tray	70472-001
ThinPrep UroCyte Microscope Slides	100 slides per box (approximately 100 slides)	70471-001
ThinPrep UroCyte PreservCyt Cups	100 cups per case	ASY-14760
ThinPrep Arcless Microscope Slides (for IHC stains)	Box, 1/2 gross (approximately 72 slides)	70126-002
ThinPrep Non-gynecological Micro- scope Slides	100 slides per box (approximately 100 slides)	70372-001



ORDERING INFORMATION

Pipette Tips, Available from Tecan, www.tecan.com

Disposable pipette tips, 1,000µl, conductive, liquid-sensing	9600 tips per case	10612513
Box to support disposable pipette tips (The base of the box can be used to support the pipette tips when loading the pipette tip gripper.)	10 boxes per case	30058507

Injection Solutions Available from Baxter Healthcare Corporation 1-800-933-0303

Plasma-Lyte [®] A Injection pH 7.4	500 ml	2B2543
Plasma-Lyte [®] A Injection pH 7.4	1000 ml	2B2544



Index

Weight 1.17

A

About 6.55
absorbent pad
 filter plug 8.19
 filter puncture 8.19
Administrative Options 6.9
alarm, audible 6.16
Alert tones 6.16
Aliquot 7.35
 overview 1.1
Aliquot + slide 7.37
Aliquot error, clog or strand 9.3
Ancillary Testing 7.2
append characters 6.47
Aptima specimen transfer tube 1.1
As needed maintenance 8.13
audible alarm 6.16
Auto-start with Door Close 6.17

B

barcode label format
 slide 7.10
 vial 7.8
barcode scanning 6.2
bloody fluid 5.20
body fluids 5.20

C

Cancel sample processing 7.47



INDEX

Cell collection	1.11
Cell transfer	1.12
cerebrospinal fluid	5.20
Chain of custody	6.18
change absorbent pads	8.19
change fixative reagent	8.3
clean	
door	8.7
pipette tip disposal cup	8.4
pipette tip holder	8.20
pipettor	8.6
slide nest and slide grippers	8.3
slide printer print head	8.7
touch screen	8.6
tube printer print head	8.24
Clean Screen button	6.25
Clear lines	8.18
clear media	9.5
release filter	9.8
release pipette tip	9.9
release slide	9.7
release tube	9.9
release tube cap	9.9
release vial cap	9.7
Clear Media button	6.24
Clearances	1.17
Collection	
Broom-like device	4.4
Endocervical brush/Spatula device	4.5
fluids, FNA	5.17
fluids, Non-Gyn	5.17, 5.29
Communication to	
slide printer	6.25
tube printer	6.26
Configure	
barcode types in IDs	6.40
slide ID	6.52
slide ID, append characters	6.47
slide ID, insert characters	6.47
slide ID, replace characters	6.47



slide ID, segment of ID	6.46
tube ID	6.54
tube ID, append characters	6.47
tube ID, insert characters	6.47
tube ID, replace characters	6.47
tube ID, segment of ID	6.46
vial ID	6.51
vial ID, no unique characteristics	6.42
vial ID, unique characteristic, ending characters	6.44
vial ID, unique characteristic, fixed length	6.43
vial ID, unique characteristic, segment of ID	6.43
vial ID, unique characteristic, starting characters	6.44
vial ID, unique characteristics	6.41
Configure barcodes	6.38
Coverslipping	10.6
CytoLyt Solution	3.5
composition	3.5
handling/disposal	3.6
packaging	3.5
stability	3.5
storage requirements	3.5
wash	5.15

D

Daily maintenance	8.1
data entry	6.2
Date/time	6.11
Design slide labels	6.26
Design tube labels	6.36
Dimensions	1.17
disable Chain of Custody	6.18
Dispersion	1.10
Disposal	
consumables	1.26
cup, pipette tips	6.8
waste electrical and electronic equipment (WEEE)	1.26
DiThioThreitol (DTT)	5.19
Door	



INDEX

cleaning	8.7
closing	7.15
opening and closing	7.11
Door close, auto-start	6.17

E

Empty Liquid Waste	
bottle	8.13
button	6.24
enable Chain of Custody	6.18
Ending characters	6.44
enter data	6.2
keypad	6.3
Environmental	1.18
error	
filter handling	9.11
pipette tip handling	9.12
slide handling	9.11
tube handling	9.12
vial cap	9.11
vial handling	9.11
Error code format	9.16
Extended shutdown	2.8

F

Filter	
detection	9.4
wetting	1.11
Filter handling error	9.11
fine needle aspirates	5.5, 5.17
Fixation	10.2
Fixation, staining, coverslipping	10.1
Fixative bath	6.7
fluid specimens	5.6
fuse	1.18



fuses, user-replaceable 8.26, 8.28, 8.29

G

glacial acetic acid 5.30

Gyn sample type button 6.7

H

handling error 9.5

I

insert characters 6.47

Installation 2.1

Instrument name 6.13

Instrument operation 7.1

Items to process 6.6

 Aliquot 6.6

 Aliquot + Slide 6.6

 Slide 6.6

J

Jog Filter Plug button 6.25

K

keypad 6.3

L

Lab name 6.12

Labels

 used on the system 1.23



INDEX

labels
 vial 7.8
Language 6.12
liquid waste 6.8, 8.13
Load Pipettes Tips button 6.24
Load the Pipette Tips .ii
Loading
 Fixative bath 7.18
 pipette tips 7.19
Location selection 2.2
Log in 6.4
Lower text, slide label design 6.35
lubricant 4.7

M

Main menu 6.4
Maintenance
 as needed 8.13
 daily 8.3
 schedule 8.30
 system 6.23
 weekly 8.4
Material requirements 1.6, 7.4
Media handling errors 9.11
Moving to a new location 8.25
mucoid specimens 5.6, 5.14, 5.18, 5.27
mucus 5.15, 5.19

N

Non-Gyn filters 7.6
Non-Gyn sample type button 6.7
Normal shutdown 2.7



O

Obstruction in vial	9.2
OCR label format	7.10
Operating instructions	7.1
Ordering Information	13.1
Other sample types, Non-Gyn	5.6

P

Pipette handling error	9.12
pipette tip disposal cup	6.8
pipette tip disposal cup, cleaning	8.4
pipette tip holder, cleaning	8.20
Pipette tips	6.8
Plasma-Lyte	5.6
Polysol	5.6
Power	1.18
power button, slide printer	1.15
power switch, processor	2.6
power switch, tube printer	1.16
Power On Self Test	1.20
PreservCyt Solution	3.1
composition	3.1
handling/disposal	3.3
packaging	3.1
stability	3.2
storage requirements	3.1
Print	
slide label	7.17
tube label	7.13
printer	
slide	7.9
tube	7.9
processing	
aliquot	7.35
aliquot+slide	7.40
slide	7.28

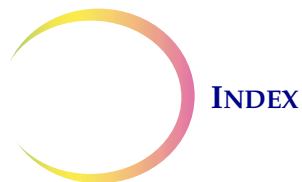

protein 5.30
Protein precipitation 5.15

R

red blood cells 3.5, 5.15
release filter 9.8
release pipette tip 9.9
release slide 9.7
release tube 9.9
release tube cap 9.9
release vial cap 9.7
remove aliquot and process slide 7.37
Remove an aliquot 7.35
Remove an aliquot manually 7.2
repair ribbon in slide printer 9.15
replace
 slide printer print head 8.22
replace characters 6.47
replace fuses 8.26, 8.28, 8.29
Replace slide printer ribbon 8.21
Reports 6.56
 System events 6.61
 usage details 6.60
 vial 6.57
Reposition robot 9.6
Reprocessing following an 'Unsat' slide 4.9
Required materials 7.4
 aliquot removal 7.5
 aliquot+slide process 7.5
 Non-Gyn testing 5.3
 slide processing 7.5
Restricted mode 9.14
Restricted mode, error condition 9.14
Review and save configuration 6.50
Ribbon, slide printer 8.21
routine maintenance 8.1



S

- Safety Data Sheet
 - CytoLyt Solution 3.6
 - PreservCyt Solution 3.4
 - tube 3.1
- saline solution 5.30
- Sample is Dilute 9.3
 - bloody or proteinaceous 5.25
 - muroid specimen 5.27
- sample processing errors 9.1
- Sample too dense, Non-Gyn 9.2
- Sample types 6.7
- sample vial holder 6.8
- Save report to USB 6.63
- scan data 6.2
- Secondary data, slide label design 6.31, 6.32, 6.33
- segment of ID 6.43, 6.46
- serous effusions 5.20
- Service button 6.25
- Shutdown 2.7
 - extended 2.8
- slide grippers, cleaning 8.3
- Slide handling error 9.11
- Slide ID
 - append characters 6.47
 - configure 6.52
 - entire slide ID in vial ID, pre-printed 6.49
 - entire vial ID, pre-printed 6.48
 - failed to match 9.3
 - failed to read 9.3
 - insert characters 6.47
 - replace characters 6.47
 - segment of ID 6.46
 - segment of slide ID in vial ID, pre-printed 6.49
 - segment of vial ID, pre-printed 6.48
 - slide label design 6.27, 6.28, 6.29, 6.30
 - Test Configuration 6.50, 6.53
- Slide label 6.26



INDEX

barcodes	6.30	
format for ThinPrep Imaging		7.10
print	7.17	
Slide labels	7.9	
slide nest, cleaning	8.3	
Slide printer	6.25, 7.9,	7.15
clean print head	8.7	
load	7.15	
repair ribbon	9.15	
replace print head	8.22	
replace ribbon	8.21	
ribbon not recognized	9.16	
slide jam	9.14	
sound	6.15	
Specimen transfer tube	1.1	
holder	6.8	
Staining	10.3	
Start with door close	6.17	
Starting characters	6.44	
status indicators	6.7	
Storage		
CytoLyt Solution	3.5	
non-Gyn vial	3.2	
PreservCyt Solution	3.1	
tube	3.2	
vial	3.2	
Storage and handling, processor	2.5	
superficial specimen	5.21	
Symbols used on the system	1.21	
System error	9.13	
System Events button	6.61	
System events report	6.61	
System maintenance button	6.23	
System settings	6.10	
Alert tones	6.16	
Auto-start with Door Close	6.17	
Chain of Custody	6.18	
date/time	6.11	
instrument name	6.13	



lab name	6.12
language	6.12
sound	6.15
System Maintenance	6.23

T

Temperature	
instrument operation	1.18
instrument storage	1.18
Test Configuration	6.50
Slide ID	6.53
Tube ID	6.55
Vial ID	6.52
ThinPrep Pap Test	1.2
ThinPrep Pap Test filters	7.6
ThinPrep Pap Test Training Program	11.1
Touch screen, cleaning	8.6
troubleshooting	9.1
troubleshooting, Non-Gyn sample prep	5.30
tube	1.1
Tube fluid level too low	9.2
Tube fluid too high	9.2
Tube handling error	9.12
Tube holder	6.8
Tube ID	
append characters	6.47
configure	6.54
entire tube ID in vial ID, pre-printed	6.49
entire vial ID, pre-printed	6.48
insert characters	6.47
replace characters	6.47
segment of ID	6.46
segment of tube ID in vial ID, pre-printed	6.49
segment of vial ID, pre-printed	6.48
Test Configuration	6.50, 6.55
Tube labels	6.36, 7.9
barcodes	6.37
Tube printer	6.26, 7.9, 7.13



clean print head	8.24
Turning off the processor	2.7
Turning on the system	2.6

U

Unloading	
aliquot+slide	7.45
slide	7.31, 7.45
tube	7.37
Upper text, slide label design	6.34
urine	5.20
cytology processing	5.22
UroCyte filters	7.6
UroCyte sample type button	6.7
UroVysion assay	5.22
Usage details report	6.60
USB	
port, back of the processor	2.6
port, front of the processor	1.15
save report	6.63
User interface screens	6.1
User Preferences	2.7

V

vial cap handling error	9.11
Vial fluid level too high	9.2
Vial fluid level too low	9.2
vial handling error	9.11
vial holder	6.8
Vial ID	
configure	6.51
no unique characteristics	6.42
Test Configuration	6.50, 6.52
Vial ID, unique characteristics	6.41
ending characters	6.44



fixed length 6.43
segment of ID 6.43
starting characters 6.44
Vial labels 7.8
Vial reports 6.57
voltage 1.18
volume, sound 6.15

W

Warnings, Cautions, Notes 1.20
waste bottle 6.8, 8.13
 connection 8.17
waste electrical and electronic equipment (WEEE) 1.26
Weekly maintenance 8.4
Weight 1.17

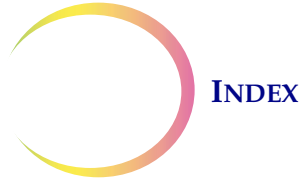

This page intentionally left blank.

Hologic®

ThinPrep®
Genesis™ Processor

Operator's Manual



Hologic, Inc.
250 Campus Drive
Marlborough, MA 01752 USA
+1-508-263-2900
www.hologic.com

MAN-05394-003 Rev. 003