



Selenia[®] Full Field Digital Mammography System

User Guide

MAN-04094 Revision 002

Selenia[®]
Digital Mammography System

HOLOGIC[®]

Selenia[®]

Digital Mammography System

User Guide

For Software Version 5.3

Part Number MAN-04094

Revision 002

June 2015

Technical Support:

USA: +1.877.371.4372

Europe: +32.2.711.4690

Asia: +852.37487700

All Other: +1.781.999.7750

HOLOGIC[®]



Manufacturer

36-37 Apple Ridge Road
Danbury, CT 06810 USA



Europe
(EU Representative)

Hologic NV
Leuvensesteenweg 250A
1800 Vilvoorde, Belgium
Tel: +32.2.711.4680
Fax: +32.2.725.2087

Refer to the corporate website for more facilities worldwide.

© Copyright Hologic 2015. All rights reserved. Printed in USA. This manual was originally written in English.

Hologic and the Hologic Logo are trademarks or registered trademarks of Hologic, Inc. Other trademarks registered or used by Hologic and its divisions and subsidiaries in the United States and other countries include: Affirm, ATEC, C-View, Dimensions, DSM, Eviva, FAST Paddle, Hologic Connect, HTC, M-IV, MultiCare, Selenia, Smart Paddle, StereoLoc, TechMate, and Trident. Microsoft and Windows are trademarks or registered trademarks of Microsoft Corporation in the United States and other countries. Any other product and company names mentioned herein are the trademarks or registered trademarks of their respective owners.

Table of Contents

List of Figures _____ ix

List of Tables _____ xi

1: Introduction _____ **1**

1.1 Intended Use..... 1
 1.1.1 Indications For Use..... 2
 1.1.2 Contraindications..... 2
 1.1.3 Potential Adverse Effects..... 2
1.2 Intended Use for the User Guide..... 2
1.3 Summary of Clinical Studies..... 2
1.4 Product Complaints..... 2
1.5 Technical Support..... 2
1.6 Warranty Statement..... 3
1.7 Hologic Cybersecurity Statement..... 3
1.8 Quality Control Requirements..... 3
1.9 Installation Instructions..... 3
1.10 User Profiles..... 4
 1.10.1 Mammography Technologist..... 4
 1.10.2 Radiologist..... 4
 1.10.3 Medical Physicist..... 4
1.11 Training Requirements..... 4
1.12 Terms and Definitions..... 5
1.13 International Symbols..... 7
1.14 Warnings, Cautions, and Notes..... 8

2: General Information _____ **9**

2.1 Warnings and Precautions..... 9
2.2 Radiation Safety..... 13
 2.2.1 Exposure Duration..... 13
 2.2.2 Operator Radiation Shield..... 13
 2.2.3 Patient Face Shield..... 13
 2.2.4 Exam Room Door Indicators..... 13
2.3 Mechanical Safety..... 13
2.4 Emergency Off Switches..... 13
2.5 Interlocks..... 14
2.6 Compliance..... 14
 2.6.1 Compliance Requirements..... 14
 2.6.2 Compliance Statements..... 15
2.7 Label Locations..... 17

Selenia User Guide

Table of Contents

3: System Components and Controls	21
3.1 System Description	21
3.2 Film Printer	22
3.3 System Power Controls	22
3.3.1 Input Power Circuit Breakers	22
3.3.2 Emergency Off Switches	23
3.4 Acquisition Workstation Controls and Display	24
3.4.1 Acquisition Workstation	24
3.4.2 Keypads	25
3.4.3 Keyboard and Trackball or Mouse	25
3.4.4 Keyboard and Screen Controls	26
3.4.5 Bar Code Scanner	26
3.4.6 The Selenia Display	27
3.5 Tubestand Controls and Displays	27
3.5.1 Gantry Controls and Displays	28
3.5.2 C-arm Controls and Displays	29
3.5.3 Dual Function Footswitches	30
4: Startup, Functional Tests, and Shutdown	31
4.1 Procedure for Startup	31
4.2 Controls and Functional Tests	33
4.3 Monthly System Tests	38
4.4 How to Restart the System	38
4.4.1 Restart From Sleep Mode	38
4.4.2 Restart After the Emergency Off Switch was Activated	38
4.4.3 How to Turn On or Reset the Uninterruptible Power Supply (UPS)	39
4.4.4 How to Turn Off the UPS	39
4.5 How to Log Out	40
4.6 How to Shut Down the System	40
5: The Selenia Accessories	41
5.1 Patient Face Shield	41
5.1.1 How to Install the Face Shield on the Tubehead	41
5.1.2 How to Remove the Face Shield	41
5.2 Compression Paddles	42
5.2.1 How to Install the Compression Paddles	42
5.2.2 How to Remove a Compression Paddle	42
5.2.3 Maintenance and Cleaning	42
5.2.4 Smart Paddle System	43
5.2.5 FAST Paddle Use	43
5.2.6 How to Realign the Paddle Front Edge	44
5.2.7 Identification of Compression Paddles	45
5.3 Magnification Platform	47
5.3.1 How to Install the Magnification Platform	47
5.3.2 How to Remove the Magnification Platform	47

5.4	The Localization Crosshair Device	48
5.4.1	How to Install the Crosshair Device.....	48
5.4.2	How to Remove the Crosshair Device	48
5.4.3	Localization Crosshair Device to the Localization Paddle Alignment	49
5.5	The Magnification Crosshair Device	49
 6: The User Interface		 51
6.1	Introduction to the User Interface	51
6.2	Select Patient Screen	52
6.2.1	Introduction.....	52
6.2.2	Select a Patient.....	53
6.2.3	How to Add a New Patient	54
6.2.4	How to Edit the Existing Patient Data	55
6.2.5	New, Edit, Add a Procedure	56
6.2.6	Image Output	58
6.2.7	Exposure Information	58
6.2.8	Menu Bar.....	64
6.2.9	Special Modes Buttons	78
6.2.10	Generator Status.....	79
6.2.11	System Messages.....	79
6.2.12	Alarms	79
6.3	Patient Views Screen	80
6.3.1	Patient Views.....	80
6.3.2	Work with Views	81
6.3.3	Acquire Images	82
6.4	Preview Image Screen	83
6.4.1	Introduction.....	83
6.4.2	The Preview Image	83
6.4.3	Tools for Image Enhancement and Annotation.....	85
6.4.4	Accept or Reject.....	96
6.4.5	Additional Information About Accepted/Rejected Images.....	97
6.5	A Screening Exam Sequence Suggestion.....	99
 7: Maintenance and Cleaning		 103
7.1	General Information About Cleaning	103
7.1.1	For General Cleaning.....	103
7.1.2	To Prevent Possible Injury or Equipment Damage.....	104
7.2	Care and Cleaning— Acquisition Workstation and Value Console	104
7.2.1	How to Clean the Preview Display	104
7.2.2	How to Clean the Keyboard.....	105
7.3	Preventive Maintenance.....	105

Selenia User Guide

Table of Contents

Appendix A System Specifications	107
A.1 Dimensional Information.....	107
A.1.1 Tubestand (Gantry with C-arm)	107
A.1.2 Acquisition Workstation	107
A.1.3 Selenia Value Console	108
A.2 Operating Environment	108
A.2.1 General Operating Conditions	108
A.3 Storage Environment.....	108
A.3.1 Tubestand.....	108
A.3.2 Image Receptor.....	108
A.4 Electrical Input	109
A.4.1 Tubestand.....	109
A.4.2 Acquisition Workstation	109
A.5 Acquisition Workstation Technical Information	109
A.6 Tubestand Technical Information.....	110
A.6.1 C-arm	110
A.6.2 Compression.....	110
A.6.3 X-ray Tube: Molybdenum.....	111
A.6.4 X-ray Tube: Tungsten	112
A.6.5 X-ray Collimation.....	113
A.6.6 Light Field Indication	113
A.7 Imaging System Technical Information	116
A.7.1 Image Receptor.....	116
A.8 Tissue Exposure Control (TEC) Mode	117
A.9 Automatic Exposure Control (AEC).....	118
A.10 Hardcopy Film Printing Devices	119
A.10.1 Image Engine.....	119
A.10.2 Interface.....	119
A.10.3 Printed Film.....	119
Appendix B The Mobile Selenia	121
B.1 General Information	121
B.1.1 The Vertical Position Override Switch (VPOS).....	121
B.2 Safety Conditions and Other Precautions	122
B.3 Mobile Specifications.....	123
B.3.1 Shock and Vibration Limits	123
B.3.2 Coach Environment	123
B.3.3 Electrical Input	124
B.4 How to Prepare the System for Transport.....	124
B.5 How to Test the System Integrity After Transport.....	125
Index	127

List of Figures

Figure 1: Selenia Label Locations.....	17
Figure 2: Value Console Label Locations	17
Figure 3: Selenia System Description.....	21
Figure 4: Gantry Circuit Breaker	22
Figure 5: Acquisition Workstation Circuit Breaker.....	22
Figure 6: Emergency Off Switch	23
Figure 7: Acquisition Workstation Emergency Off Switch.....	23
Figure 8: Value Console Emergency Off Switch.....	23
Figure 9: Gantry Emergency Off Switches	23
Figure 10: The Acquisition Workstation Controls.....	24
Figure 11: The Selenia Value Console Controls.....	24
Figure 12: Keypad Controls.....	25
Figure 13: Selenia Keyboard.....	25
Figure 14: Selenia Function Keys on the Keyboard.....	26
Figure 15: Tubestand	27
Figure 16: Gantry Controls	28
Figure 17: Compression Device	30
Figure 18: The Dual Function Footswitch	30
Figure 19: Emergency Off Switch	31
Figure 20: Gantry Circuit Breakers.....	31
Figure 21: Acquisition Workstation Circuit Breaker.....	31
Figure 22: Power On Button and LED	32
Figure 23: The Acquisition Workstation UPS Switch Lever	39
Figure 24: Value Console UPS Switch.....	39
Figure 25: The Sign Out Button.....	40
Figure 26: Exit from Acquisition Station Dialog Box	40
Figure 27: Installation of the Face Shield.....	41
Figure 28: Mount the Compression Paddle.....	42
Figure 29: Shifting Compression Paddle	43
Figure 30: Alignment of the Paddle	44
Figure 31: Alignment of Adjustment Screws	44
Figure 32: Magnification Platform Installation.....	47
Figure 33: Installation of the Crosshair Device.....	48
Figure 34: Crosshair Locking Levers.....	48
Figure 35: Adjustment Lock Screw	49
Figure 36: Installation of the Magnification Crosshair Device	49
Figure 37: The Select a Patient Screen	52
Figure 38: New Patient Entry Form.....	54
Figure 39: The Edit Patient Dialog Box.....	55
Figure 40: New Procedure, Edit a Procedure, and Add a Procedure Buttons	56
Figure 41: New Procedure Dialog Box.....	56

Selenia User Guide

Table of Contents

Figure 42: Add a New Procedure Dialog Box.....	57
Figure 43: Select the Output	58
Figure 44: Exposure Techniques	58
Figure 45: Breast Density Options	60
Figure 46: Accept TEC Exposure Techniques	60
Figure 47: The Override Mode.....	61
Figure 48: AEC Exposure and Sensor Position Adjustments.....	62
Figure 49: The Setup Screen.....	65
Figure 50: View Order Editor.....	66
Figure 51: The Edit Users Dialog Box.....	67
Figure 52: Edit Output Device Dialog Box	68
Figure 53: Choose a New Patient Dialog Box.....	70
Figure 54: Manage Queues	71
Figure 55: Image Management Resend Options.....	74
Figure 56: Location of the Gantry Serial Number	78
Figure 57: Non-Imaging Mode Button.....	79
Figure 58: The Alarm Icon	79
Figure 59: Patient View Screen.....	80
Figure 60: Buttons Used on the View Screen	81
Figure 61: Ready for Exposure Indicators	82
Figure 62: The Preview Image Screen	83
Figure 63: Hanging Options	84
Figure 64: The Preview Screen Tools	85
Figure 65: Image Comments.....	86
Figure 66: The Markers in the Preview Pane	87
Figure 67: Full Zoom/Pan Image	88
Figure 68: ROI Size Drop-down Menu	89
Figure 69: Preview with Crosshairs.....	90
Figure 70: A Measurement on the Preview Screen.....	91
Figure 71: Preview with Magnification.....	92
Figure 72: The Window/Level Settings	93
Figure 73: AEC Regions	94
Figure 74: Exposure Information	95
Figure 75: Exposure Information	95
Figure 76: The Reject Reasons List.....	96
Figure 77: A Rejected Image	96
Figure 78: Set Accepted Button on Review Screen.....	97
Figure 79: Accept Rejected Image.....	98
Figure 80: Set Rejected Button.....	98
Figure 81: Tubestand Dimensions	107
Figure 82: Acquisition Workstation Dimensions.....	107
Figure 83: Value Console Dimensions	108
Figure 84: Location of Vertical Position Override Switch (VPOS)	121

List of Tables

Table 1: Factors That Limit Exposure Duration.....	13
Table 2: Label Descriptions.....	18
Table 3: Selenia Function Keys.....	26
Table 4: System Startup Procedures.....	31
Table 5: Monthly Control Function Tests.....	33
Table 6: The Log Out Methods.....	40
Table 7: Exposure Modes.....	59
Table 8: AEC Alarm Messages.....	63
Table 9: Menu Bar Options and Functions.....	64
Table 10: User Setup Options.....	67
Table 11: How to Use Manage Queues.....	72
Table 12: Actions on the Patient Views screen.....	80
Table 13: View Options.....	81
Table 14: Workflow Suggestions to Select a Patient and Acquire an Image.....	99
Table 15: User Preventive Maintenance.....	105
Table 16: Collimation Settings.....	113
Table 17: LFS mA setting as a function of kV.....	114
Table 18: SFS mA setting as a function of kV.....	114
Table 19: mA Factor as a function of mAs.....	114
Table 20: Integrity Checklist.....	125

Chapter 1: Introduction

The Selenia®, based on the M-IV™ Mammography X-ray System, uses an Image Acquisition system that includes a digital image receptor. This receptor, which covers an area of 24 cm x 29 cm, is a direct-capture detector using an amorphous selenium photoconductor. At the Acquisition Workstation the user selects x-ray exposure technique factors, adds patient identification data, acquires, processes, and displays the digital images. The images are then either processed for printing and transmitted to peripheral hard copy laser film printer or sent to a diagnostic review workstation or both. Contrast and brightness are set automatically and can be adjusted by the user prior to printing or viewing. Hard-copy printers and a diagnostic review workstation are available as options.

The patient is prepared for the procedure in the same manner as for a film-based system. The Acquisition Workstation provides direct digital acquisition system advantages in system efficiency and productivity including:

- Patient demographics are associated with the electronic image.
- Technologist comments can be associated with the image.
- The technologist is assisted through the steps of image acquisition.
- Possible image destinations are provided via configurable settings.
- The technologist may review past acquisitions (including priors), to see previous captures, and then resend, and/or remark them.

1.1 Intended Use

R_x Only Caution: Federal law restricts this device to sale by or on the order of a physician.

The Selenia is intended to produce radiographic images of the breast. Its intended use is for the production, storage, and diagnostic review of digital screening, diagnostic, and needle localization mammography.

The system is to be used in a radiology or clinic exam room environment in a hospital, outpatient clinic, or a breast imaging center. Mammography technologists operate the system for the production and storage of digital mammograms. The system may also be used for quality control purposes and other clinical or research related activities by medical physicists and radiologists certified in accordance with MQSA standards.

- The Selenia Acquisition Workstation display is not approved for final interpretation of examinations. Final interpretations should be done from either films or with the diagnostic review workstation. Images shown on the Acquisition Workstation display are for quality assurance or confirmation purposes only.
- Only images produced by recommended laser printers, or an approved diagnostic review workstation, should be used for final interpretation of examinations. For compatible printers, see the latest product data sheets for the system, which can be obtained from Hologic® or your sales representative.

1.1.1 Indications For Use

The Selenia Full Field Digital Mammography System generates digital mammographic images that can be used for screening and diagnosis of breast cancer. The Selenia Full Field Digital Mammography System is intended for use in the same clinical applications as traditional screen-film mammographic systems. Mammographic images can be interpreted on either hard copy film or the diagnostic review workstation.

1.1.2 Contraindications

There are no known contraindications.

1.1.3 Potential Adverse Effects

The following is a list of potential adverse effects that apply to mammography and are also applicable to digital mammography using the Selenia.

- Excessive breast compression
- Excessive x-ray exposure
- Electric shock
- Infection
- Skin irritation, abrasions, or puncture wounds

1.2 Intended Use for the User Guide

Always refer to the User Guide for instructions on using the system.

1.3 Summary of Clinical Studies

This information is available in the document MAN-02233.

1.4 Product Complaints

Report any complaints or problems in the quality, reliability, safety, or performance of this product to Hologic. If the device has caused or added to patient injury, immediately report the incident to Hologic. (See the title page for contact information.)

1.5 Technical Support

Refer to the title page of this manual for contact information for product support.

1.6 Warranty Statement

Except as otherwise expressly stated in the Agreement: i) Equipment manufactured by Hologic is warranted to the original Customer to perform substantially in accordance with published product specifications for one (1) year starting from the date of shipment, or if Installation is required, from the date of Installation (“Warranty Period”); ii) digital imaging mammography x-ray tubes are warranted for twenty-four (24) months, during which the x-ray tubes are fully warranted for the first twelve (12) months and are warranted on a straight-line prorated basis during months 13-24; iii) replacement parts and remanufactured items are warranted for the remainder of the Warranty Period or ninety (90) days from shipment, whichever is longer; iv) consumable Supplies are warranted to conform to published specifications for a period ending on the expiration date shown on their respective packages; v) licensed Software is warranted to operate in accordance with published specifications; vi) Services are warranted to be supplied in a workman-like manner; vii) non-Hologic Manufactured Equipment is warranted through its manufacturer and such manufacturer’s warranties shall extend to Hologic’s customers, to the extent permitted by the manufacturer of such non-Hologic Manufactured Equipment. Hologic does not warrant that use of Products will be uninterrupted or error-free, or that Products will operate with non-Hologic authorized third-party products.

1.7 Hologic Cybersecurity Statement

Hologic continuously tests the current state of computer and network security to examine possible security problems. When necessary, Hologic provides the updates to the product. For Cybersecurity Best Practices documents for Hologic products, refer to the Hologic Internet site.

1.8 Quality Control Requirements

The facilities in the United States must use the Quality Control Manual to create a Quality Assurance and Quality Control program. The facility must create the program to meet the requirements of the Mammography Quality Standards Act or to be accredited by ACR or another accreditation body.

The facilities outside the United States can use the Quality Control Manual as a guide to create a program to meet the local standards and regulations.

1.9 Installation Instructions

Installation instructions are available in the Service Manual.

1.10 User Profiles

1.10.1 Mammography Technologist

- Meets all requirements that apply to the location in which the Mammography Technologist operates.
- Completed training on the mammography system.
- Has training in mammography positions.
- Knows how to operate a computer and its peripherals.

1.10.2 Radiologist

- Meets all requirements that apply to the location in which the Radiologist operates.
- Knows how to operate a computer and its peripherals.

1.10.3 Medical Physicist

- Meets all requirements that apply to the location in which the Medical Physicist operates.
- Knows about mammography.
- Has experience with digital imaging.
- Knows how to operate a computer and its peripherals.

1.11 Training Requirements

In the United States, users must be Registered Radiologic Technologists meeting criteria to perform mammography. The mammography users must meet all applicable MQSA personnel requirements under FDA guidelines for conventional and digital mammography.

The user has options available for training, which include but are not limited to:

- Onsite applications training by a Hologic Clinical Services Specialist
- Onsite on the job training also known as peer training

Additionally, the user manual is a guide for directions on how to use the system.

All users must make sure that they receive training on correct operation of the system before use on patients.

Hologic does not accept the responsibility for injury or damage from wrong system operation.













1.12 Terms and Definitions

Accession Number	A DICOM term that refers to a RIS-created number that uniquely identifies a visit to a site by a patient.
ACR	American College of Radiology
Ag	Silver
AEC	Automatic Exposure Control. A method that limits the amount of radiation a patient receives.
collimator	Device at the x-ray tube that limits the area of the receptor that is exposed.
dialog box	A pop-up window that requires a user decision and a mouse or trackball click before another activity can occur.
DICOM	Digital Imaging and Communications in Medicine. An industry standard specification for communication between medical imaging equipment.
digital marker	A software mechanism that marks an image to show some information (normally orientation).
FAST Paddle™	Fully Automated Self-Adjusting Tilt Paddle system
Grid	Element within the Digital Image Receptor that reduces the scatter radiation during exposure
HIS/RIS	Hospital Information System/Radiology Information System. Generic term for non-PACS systems which track the Patient demographics and ordered radiological studies
HTC™	High Transmission Cellular Grid
kV	Kilovolts: One of the x-ray exposure settings.
login/logout	The process of logging into and out of the Operating System of the Acquisition Workstation
LUT	Look-Up Table (LUT). An image processing function that replaces one image pixel value with a different image pixel value.
Mag	Magnification
mA	Milliamperes. One of the x-ray exposure settings.
mAs	Milliampere-seconds. An electrical term used in x-ray exposure settings
Mo	Molybdenum
Modality Worklist (MWL)	A list of scheduled procedures normally kept by a RIS or PACS.
MPPS	Modality Performed Procedure Step. A DICOM service to allow the RIS (or another device) to know about work performed on the Acquisition Workstation.
MQSA	Mammography Quality Standards Act
Operating System (OS)	The software control system which runs all functions of a computer.

Outputs	A list of devices to which the accepted image is sent. The devices can be a combination of archives, workstations and film printers.
PACS	Picture Archiving and Communications System. A computer and network system for the transfer and archive of digital medical images
PPS Status	The condition of a Performed Procedure Step being "in progress", "completed", or "discontinued".
Procedure	A generic medical protocol which contains a set of images (Views) which are acquired under certain conditions, and are performed together for a one purpose (for example standard screening). There is no Procedure instance UID item because a Procedure is a generic item in DICOM. DICOM supports the identification of requested Procedures.
Rh	Rhodium
ROI	Region of Interest
RIS	Radiology Information System
Series	A set of images acquired by a single tech for a single Patient and Procedure on a particular modality with a fixed body part, laterality and view position. DICOM uniquely identifies the series with a globally unique instance UID. Based on this description, each individually acquired DR image on the Acquisition Workstation is also an individual series.
Sign-in	The process of user identification to the Acquisition Workstation application.
Sign-out	The process in which a user exits the Acquisition Workstation application, but the user does not logout of the OS.
Smart Paddle™	A paddle with a release knob on each side which allows the paddle to move from one side of the image detector to the other. The system identifies a Smart Paddle installed on the compression device.
TEC	Tissue Exposure Control mode, an enhanced Manual Exposure Control (MEC) mode.
technique	Combination of x-ray parameters (kV, mA, etc.) for a specified view in a procedure.
UPS	Uninterruptible Power Supply.
View	The combination of a single x-ray image and a specified set of conditions under which the image was acquired. The View is not part of DICOM nomenclature, but in the context of DR, is approximately synonymous with a DICOM image object.
W	Tungsten
Wildcard Character	A keyboard character that represents one or many characters, for example the * or ?.

1.13 International Symbols

This section describes the International Symbols on this system.

	Type B Applied Part
	Protective Earth terminal
	"OFF" (power)
	"ON" (power)
	"OFF" for part of the equipment
	"ON" for part of the equipment
	Power Standby
	Discard electrical and electronic equipment separately from standard waste. Send decommissioned material to Hologic or contact your service representative.
	Dangerous Voltage
	Manufacturer
	Date of Manufacture
	Caution—Radiation

1.14 Warnings, Cautions, and Notes

Descriptions of Warnings, Cautions, and Notes used in this manual:



WARNING!

The procedures that you must follow accurately to prevent possible dangerous or fatal injury.



Warning:

The procedures that you must follow accurately to prevent injury.



Caution:

The procedures that you must follow accurately to prevent the damage to equipment, loss of data, or damage to files in software applications.



Note

Notes show additional information.

Chapter 2: General Information

2.1 Warnings and Precautions

Read and understand this manual before you use the system. *Always* follow all the instructions in this manual.

This system is for use by qualified Operators only. The Operators must have experience in the principles of mammography before following the instructions contained in this manual.



This system is classified as CLASS I, TYPE B APPLIED PART, IPX0, permanently connected equipment, continuous operation with short term loading per IEC 60601-1. There are no special provisions to protect the system from flammable anesthetics or ingress of liquids.



WARNING!

Risk of electric shock. Only connect this equipment to supply mains with Protective Earth.



WARNING!

Only trained Service Engineers authorized through Hologic can open any of the panels. This system contains lethal voltages.



WARNING!

Electrical equipment used near flammable anesthetics can cause an explosion.



WARNING!

After power failure, remove the patient from the system before you apply power.



WARNING!

To correctly isolate the system, attach only approved accessories or options to the system. Only approved personnel can change the connections.



WARNING!

Keep a 1.5 meter safe distance between the patient and any non-patient devices.
Do not install non-patient system components (like the Workflow Manager, the diagnostic review workstation, or the hard copy printer) in the Patient Area.



WARNING!

For North American electrical safety requirements, use a Hospital Grade receptacle to supply a correct Ground.



Warning:

The user or a servicing engineer must correct problems before the system is used.



Warning:

The user must prepare for preventive maintenance by an approved servicing engineer.



Warning:

This system can be dangerous to the patient and the user. Always follow the safety precautions for x-ray exposures.



Warning:

The disk drives installed in this system are a Class I Laser Product. Prevent direct exposure to the beam. Hidden laser radiation exists if the case to a disk drive is open.



Warning:

Only qualified users can use this system.



Warning:

Control the access to the equipment according to local regulations for radiation protection.



Warning:

Keep your full body behind the radiation shield during the exposure.



Warning:

This device contains dangerous material. Send decommissioned material to Hologic or contact your service representative.



Warning:

The equipment has motors. You must be careful when you adjust the equipment for patient use. Observe equipment and patient at all times during setup. If a chair is necessary, use an adjustable chair set above its minimum height.



Warning:

Put the footswitches away from the patient and C-arm area to prevent any accidental footswitch operation. When the patient has a wheelchair, put the footswitches away from the area.



Warning:

Do not leave the patient during the procedure.



Warning:

Keep the hands of the patient away from all buttons and switches at all times.



Warning:

You increase the patient dose to high levels when you increase the AEC exposure adjustment. You increase the image noise or decrease image quality when you decrease the AEC exposure adjustment.



Warning:

If a paddle touches possible infectious materials, contact your Infection Control Representative to remove contamination from the paddle.



Warning:

The bar code scanner installed in this system is a Class II Laser Product. Prevent direct exposure to the beam. Hidden laser radiation exists if the cover is opened.



Warning:

The Face Shield does not protect the patient from radiation.



Caution:

Do not use any hot source (like a heating pad) on the image receptor.



Caution:

Never turn off the Acquisition Workstation or Value Console Circuit Breaker except in emergency. The circuit breaker can turn off the Uninterruptible Power Supply (UPS) and risk data loss.



Caution:

To prevent possible damage from thermal shock to the Digital Image Receptor, follow the recommended procedure to turn off the equipment.



Caution:

Risk of data loss. Do not put any magnetic media near or on devices that create any magnetic fields.



Caution:

The system is a medical device and not a normal computer. Only make approved changes to the hardware or software. Install this device behind a firewall for network security. The computer virus protection or network security for this medical device is not supplied (for example, a computer firewall). The network security and anti-virus provisions are the responsibility of the user.



Caution:

To prevent errors and possible data loss, only use approved accessories with this equipment.

2.2 Radiation Safety

2.2.1 Exposure Duration

Table 1: Factors That Limit Exposure Duration

Normal Factors	Abnormal Factors
Manual mAs Timer	<ul style="list-style-type: none"> • Release of the X-ray button before the exposure ends. • Exposure longer than the preset "back-up time". • The independent safety hardware back-up timer. • Detection of a generator fault.

2.2.2 Operator Radiation Shield

The radiation shield meets the requirements of 21CFR 1020 and IEC 60601-2-45:2001. The shield has a rating of a 0.5 mm Pb (lead) equivalent and is permanently installed.



Caution:

Use care when cleaning the X-ray Shield to avoid excessive force and movement of the shield.



Note

Verify the shield integrity every day before use.

2.2.3 Patient Face Shield

The Patient Face Shield keeps the face of the patient out of the radiation field.

2.2.4 Exam Room Door Indicators

- The system provides for an external Power-On indicator.
- The system provides for an external X-ray Exposure In Progress indicator.

2.3 Mechanical Safety

The equipment meets the requirements of IEC 60601-1, UL 60601, and CSA 22.2 No. 601.1 by these safety features:

- The C-arm rotation braking is ensured upon loss of power.
- Compression release is disabled when a localization paddle is installed.
- Motorized compression force has a limit of 200 N (45 lb.).

2.4 Emergency Off Switches

The Emergency Off switches remove the power from the Gantry. Do not normally use the Emergency Off switches to turn off the system. See [Emergency Off Switches](#) on page 23.

2.5 Interlocks

- Display of 58 Newtons (13 lb.) or greater of compression force disables the C-arm vertical drive and rotation.
- Installation of a Localization Paddle disables the automatic compression release functions.
- Release of an **X-ray** button before the end of the exposure ends the exposure.
- Misalignment of the Light Field Mirror or the Filter prevents an x-ray exposure.
- Installation of an 18 x 24 cm shifting paddle prevents the x-ray exposure if the detected paddle position does not match the View.

2.6 Compliance

This section describes the mammography system compliance requirements and the manufacturer responsibilities.

2.6.1 Compliance Requirements

The manufacturer is responsible for the effects of safety, reliability, and performance of this equipment with the following provisions:

- The electrical installation of the room complies with the appropriate requirements.
- The equipment is used in accordance with the *User Guide*.
- Assembly operations, extensions, re-adjustments, modifications, or repairs are performed by authorized persons only.
- The installed network and communications equipment must comply with an IEC Standard, and the complete system (network/communications equipment and Selenia Mammography System) must be installed to comply with IEC 60601-1 and IEC 60601-1-1.



Caution:

Medical Electrical Equipment needs special precautions about EMC and must be installed, put into service and used according to the EMC information provided.



Caution:

Portable and mobile RF communications can affect medical electrical equipment.



Caution:

The use of unauthorized accessories and cables can result in increased emissions or decreased immunity. To keep the isolation quality for the system, attach only approved Hologic accessories or options to the system.



Caution:

The Medical Electrical (ME) Equipment or ME System should not be used adjacent to or stacked with other equipment. If adjacent or stacked use is necessary, make sure that the ME Equipment or ME System operates correctly in this configuration.



Caution:

This system is intended for use by healthcare professionals only. This system may cause radio interference or may disrupt the operation of nearby equipment. It may be necessary to take mitigation measures, such as re-orienting or relocating the equipment or shielding the location.



Caution:

Changes or modifications not expressly approved by Hologic could void your authority to operate the equipment.

2.6.2 Compliance Statements

The manufacturer states this device is made to meet the following requirements:

- CAN/CSA - ISO 13485-03 Medical Devices – Quality Management Systems – Requirements for Regulatory Purposes (Adopted ISO 13485:2003 second edition, 2003-07-15)
- CAN/CSA C22.2 NO. 60601-1-08 Medical Electrical Equipment – Part 1: General Requirements for Basic Safety and Essential Performance (Adopted IEC 60601-1:2005, third edition, 2005-12), includes Corrigendum 1:2011; also CAN/CSA C22.2 NO. 601.1-M90 (R2005) Medical Electrical Equipment Part 1: General Requirements for Safety
- EN 60601-1:2006 Medical Electrical Equipment. General Requirements for Basic Safety and Essential Performance; also EN 60601-1:1990 +A1+A11+A12+A2+A13 Medical Electrical Equipment—General Requirements for Safety
- FDA, 21 CFR [Parts 820, 900 and 1020]
- IEC 60601-1 Ed. 3.0:2005 Medical Electrical Equipment – Part 1: General Requirements for Basic Safety and Essential Performance; also IEC 60601-1 Ed. 2.0:1988 +A1+A2:1995 Medical Electrical Equipment—General Requirements for Safety
- IEC 60601-1-1Ed. 2.0:2000 Medical Electrical Equipment - Part 1-1: General Requirements for Safety - Collateral Standard: Safety Requirements for Medical Electrical Systems
- IEC 60601-1-2 Ed. 3.0:2007 Medical Electrical Equipment – Part 1-2: General Requirements for Basic Safety and Essential Performance - Collateral Standard: Electromagnetic Compatibility – Requirements and Tests

- IEC 60601-1-3 Ed. 2.0:2008 Medical Electrical Equipment – Part 1-3: General Requirements for Basic Safety and Essential Performance –Collateral Standard: Radiation Protection in Diagnostic X-Ray Equipment; also IEC 60601-1-3 Ed. 1.0:1994 Medical Electrical Equipment – Part 1: General Requirement for Safety -3. Collateral Standard: Requirements for Radiation Protection in Diagnostic X-ray Equipment
- IEC 60601-1-4 Ed. 1.1:2000 Medical Electrical Equipment – Part 1-4: General Requirements for Safety - Collateral Standard: Programmable Electrical Medical Systems
- IEC 60601-2-28 Ed. 2.0:2010 Medical Electrical Equipment - Part 2-28: Particular Requirements for the Basic Safety and Essential Performance of X-ray Tube Assemblies for Medical Devices; also IEC 60601-2-28 Ed. 1.0:1993 Medical Electrical Equipment – Part 2: Particular Requirements for the Safety of X-Ray Source Assemblies and X-ray Tube Assemblies for Medical Diagnosis
- IEC 60601-2-32 Ed. 1.0:1994 Medical Electrical Equipment – Part 2: Particular Requirements for the Safety of Associated Equipment of X-ray Equipment
- IEC 60601-2-45 Ed. 3.0:2011 Medical Electrical Equipment – Part 2-45: Particular Requirements for Basic Safety and Essential Performance of Mammographic X-Ray Equipment and Mammographic Stereotactic Devices; also IEC 60601-2-45 Ed. 2.0:2001 Medical Electrical Equipment Part 2-45: Particular Requirements for the Safety of Mammographic X-ray Equipment and Mammographic Stereotactic Devices
- ANSI/AAMI ES60601-1:2005 (IEC 60601-1:2005, MOD) Medical Electrical Equipment, Part 1: General Requirements for Basic Safety and Essential Performance, includes amendment (2010); also UL 60601-1 1st Edition: Medical Electrical Equipment, Part 1—General Requirements for Safety

2.7 Label Locations

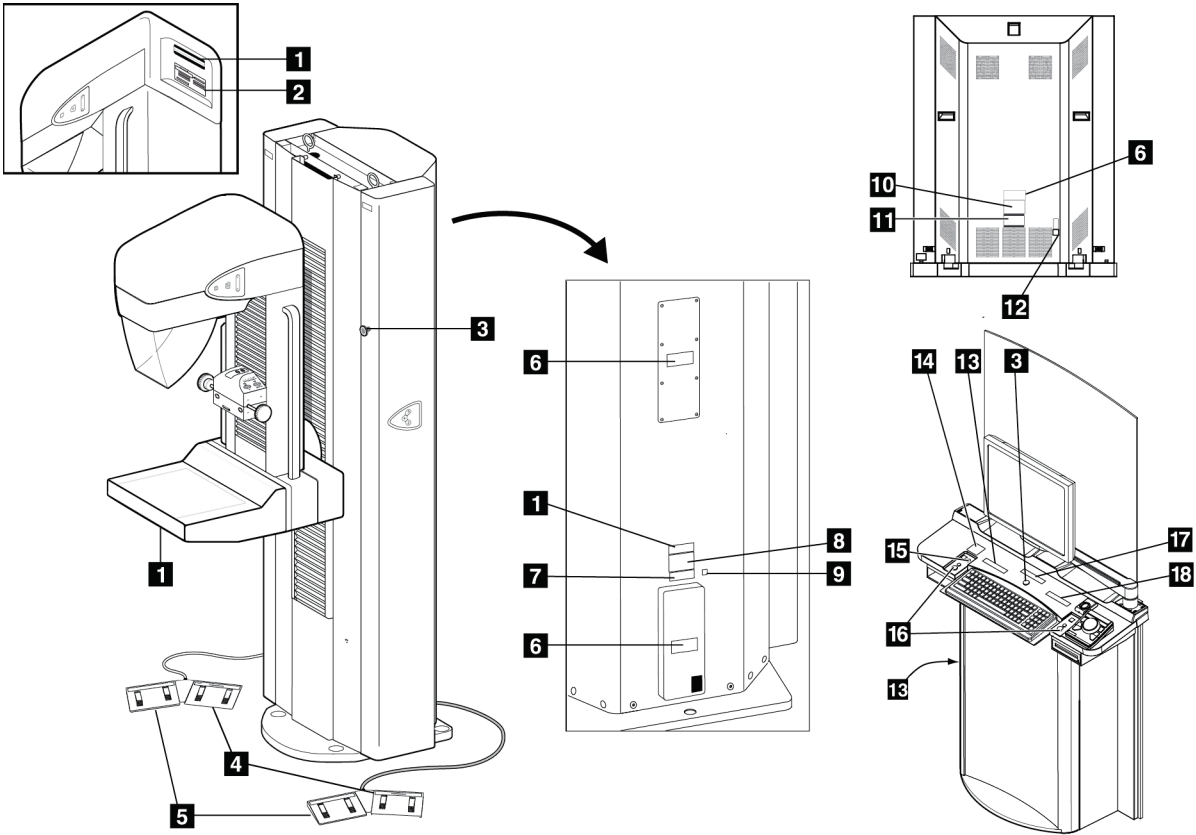

Figure 1: Selenia Label Locations

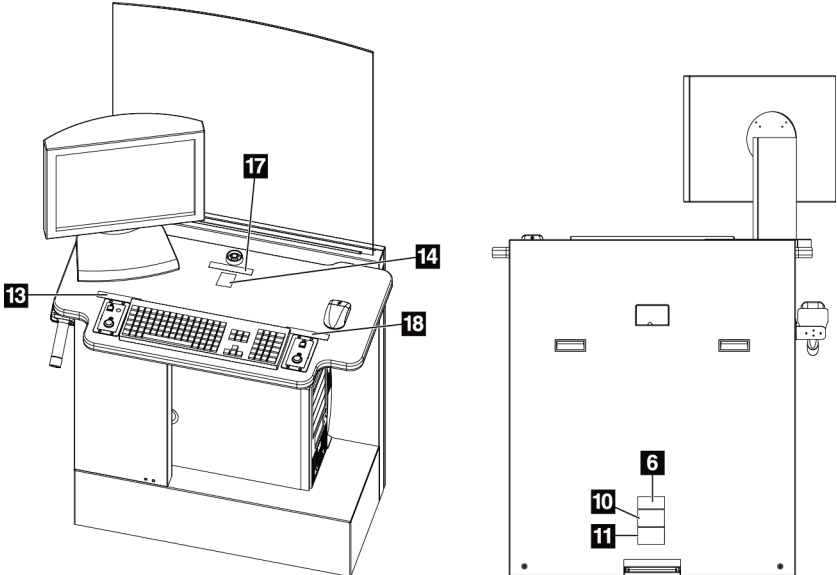

Figure 2: Value Console Label Locations

Table 2: Label Descriptions











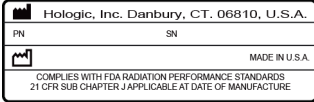
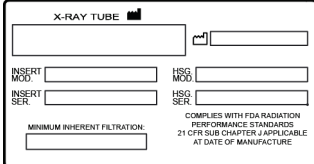

	Label Identification	Description
1		Serialized Device Label
2		X-ray Tube Serial Number
3		Emergency Stop Switch
4		Wheelchair Warning for Footswitch
5	N/A	Vendor Footswitch Label
6		Electrical Shock Warning
7		Patent Label
8		System Nameplate Label for IEC 60601-1 Third Edition Compliant Systems
8		Gantry Nameplate Label for IEC 60601-1 Second Edition Compliant Systems
9		Potential Equalization Terminal
10		Acquisition Workstation Nameplate Label for IEC 60601-1 Third Edition Compliant Systems

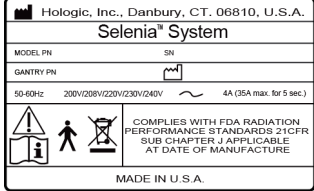
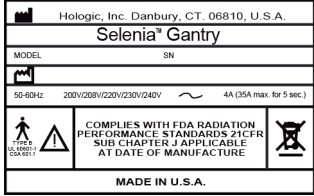
Table 2: Label Descriptions

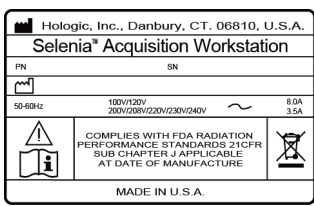
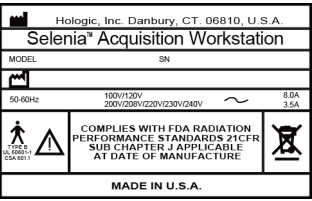
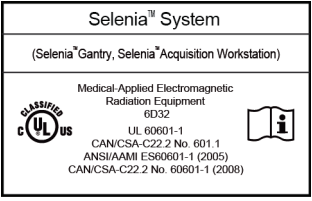
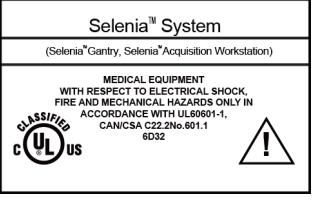
Label Identification	Description	
	Acquisition Workstation Nameplate Label for IEC 60601-1 Second Edition Compliant Systems	
11		UL (Underwriters Laboratories) Certification Label for IEC 60601-1 Third Edition Compliant Systems
		UL (Underwriters Laboratories) Certification Label for IEC 60601-1 Second Edition Compliant Systems
12		Warning for Remote UPS Power Switch
13		X-ray Device Warning
14		Technical Support Contact Label
15		"ON" for Part of the Equipment
16		Radiation Caution
17		Temperature Limit Label
18		Patient Dose Label

Chapter 3: System Components and Controls

3.1 System Description

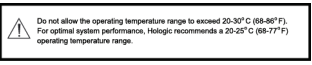
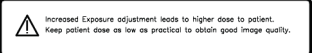
The Selenia is available with an Acquisition Workstation or a Value Console.

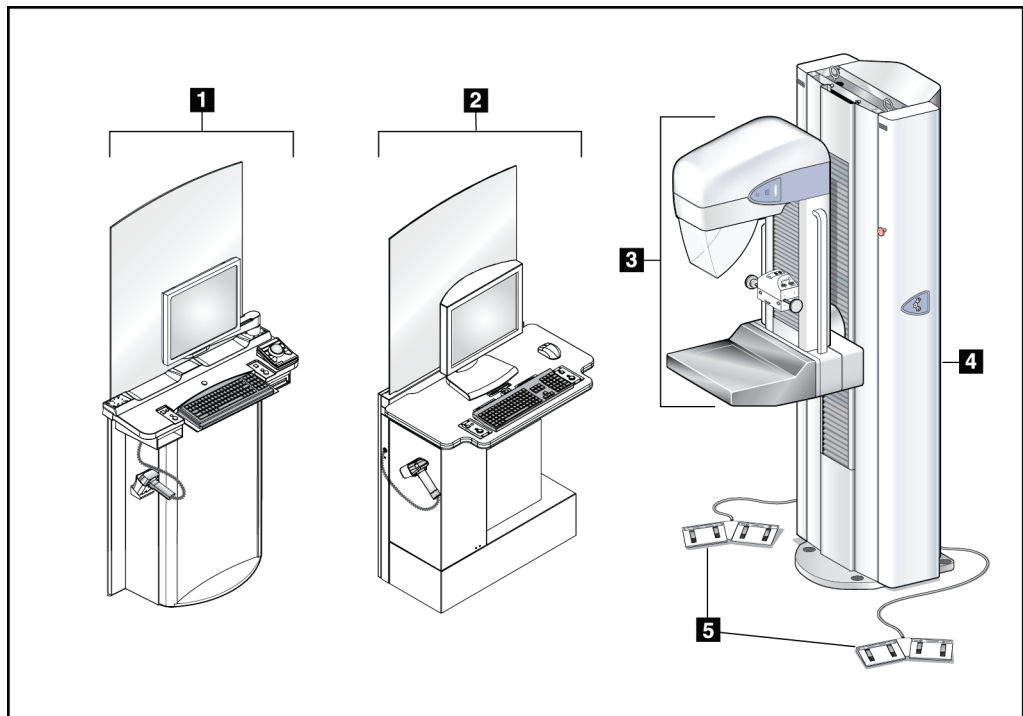

Figure 3: Selenia System Description

Figure Legend

- | | |
|------------------------------------|--|
| 1. Selenia Acquisition Workstation | |
| 2. Value Console | Contain the image processing electronics and show the user interface. |
| 3. C-arm | The C-arm provides a platform for the x-ray tube, compression systems, and the digital image receptor. A pivot mechanism connects it to the Gantry. |
| 4. Gantry | The Gantry contains the electrical and mechanical subsystems for the Selenia. The C-arm and the Gantry comprise the Tubestand. |
| 5. Dual-function Footswitches | Enables hands-free C-arm vertical travel and compression movements. |

3.2 Film Printer

Selenia accepts film printers. Printed films display the patient information, exposure techniques, projection, and facility information.

3.3 System Power Controls

3.3.1 Input Power Circuit Breakers

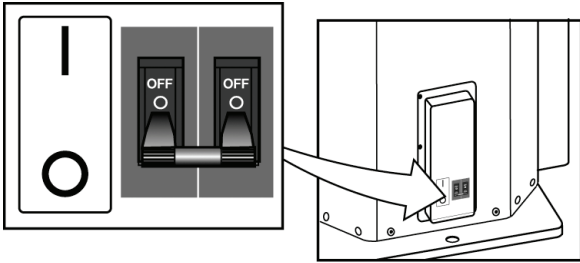
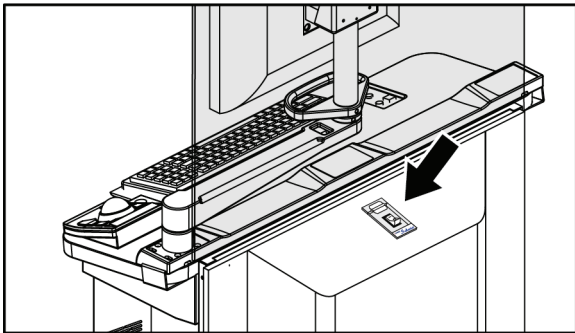
Location of Circuit Breaker	Description
 <p>The diagram shows a close-up of a circuit breaker panel with two switches labeled 'OFF'. An arrow points from this panel to a larger view of the gantry's back panel, where the circuit breaker is located.</p> <p><i>Figure 4: Gantry Circuit Breaker</i></p>	<ul style="list-style-type: none"> • At the lower right corner of the back panel • Removes the power for service or in an emergency • Up is turned On. Down is turned Off. • When turned off, a system restart is required. Restart the system following Procedure for Startup on page 31.
 <p>The diagram shows an acquisition workstation with a keyboard and mouse. An arrow points to a circuit breaker located on the back of the workstation.</p> <p><i>Figure 5: Acquisition Workstation Circuit Breaker</i></p>	<ul style="list-style-type: none"> • On the back of the Acquisition Workstation behind the shield. The Value Console Circuit Breaker (not shown) is on the back of the Value Console. • Use only in an emergency. • If the circuit breaker was used, wait until the beeps stop, then turn on the circuit breaker. The system automatically restarts. If the UPS does not respond automatically, reset the UPS. See How to Turn On or Reset the Uninterruptible Power Supply (UPS) on page 39.

3.3.2 Emergency Off Switches

- Press any Emergency Off Switch to remove Gantry power.
- Rotate the switch one-quarter turn to reset.
- Restart the system after any Emergency Off Switch is pressed. See the procedure in [Restart After the Emergency Off Switch was Activated](#) on page 38.

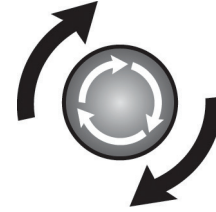

Figure 6: Emergency Off Switch

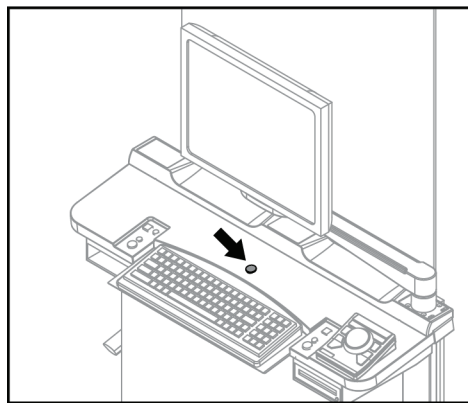

Figure 7: Acquisition Workstation Emergency Off Switch

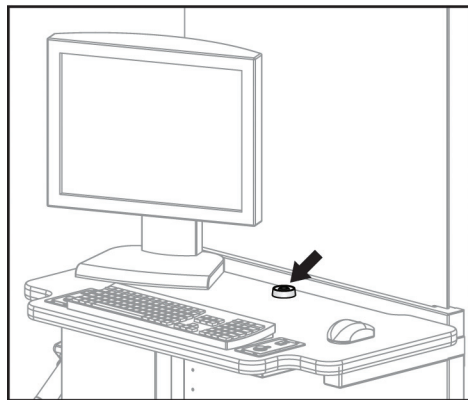

Figure 8: Value Console Emergency Off Switch

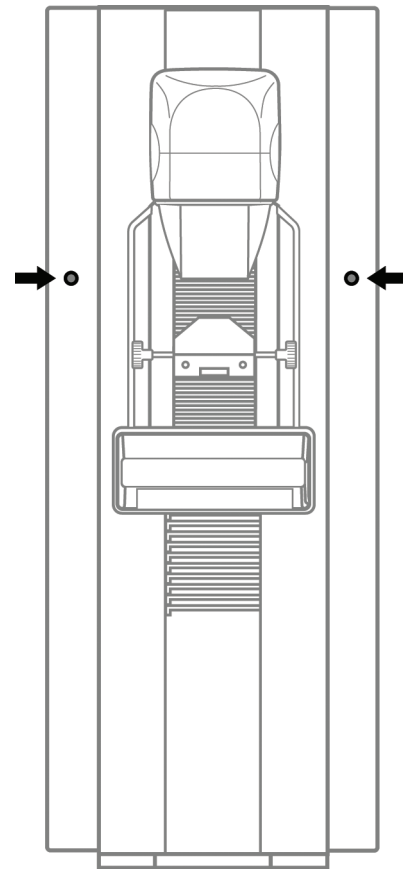

Figure 9: Gantry Emergency Off Switches

3.4 Acquisition Workstation Controls and Display

3.4.1 Acquisition Workstation

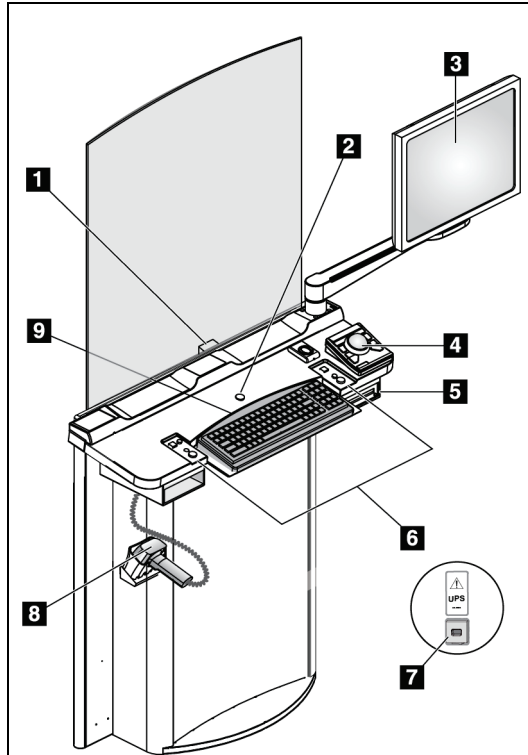

Figure 10: The Acquisition Workstation Controls

Figure Legend

- 1. Circuit Breaker
- 2. Emergency Off Switch
- 3. Selenia Display
- 4. Trackball
- 5. CD-RW Drive
- 6. Left and Right Keypads
- 7. Selenia Acquisition Workstation UPS (Uninterruptible Power Supply) **Reset** Button (on lower right back)
- 8. Bar Code Scanner
- 9. Selenia Keyboard

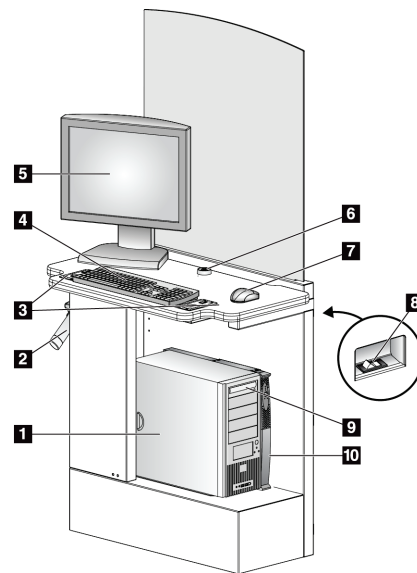

Figure 11: The Selenia Value Console Controls

Figure Legend

- 1. Computer
- 2. Bar Code Scanner
- 3. Left and Right Keypads
- 4. Keyboard
- 5. Display
- 6. Emergency Off Switch
- 7. Mouse
- 8. Circuit Breaker
- 9. CD-RW Drive
- 10. UPS

3.4.2 Keypads

The Keypads provide **Power On**, **X-ray**, and **Compression Release** functions.

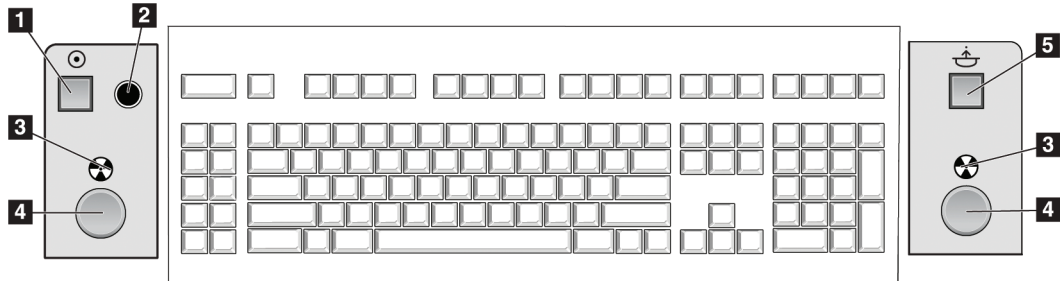

Figure 12: Keypad Controls

Figure Legend

1. **Power On** button
2. Power On indicator light
3. X-ray Indicator lights on both panels
4. **X-ray** buttons, one on each side of the keyboard. Press both at the same time to begin an x-ray exposure and hold until the tone stops.
5. **Compression Release** button

3.4.3 Keyboard and Trackball or Mouse

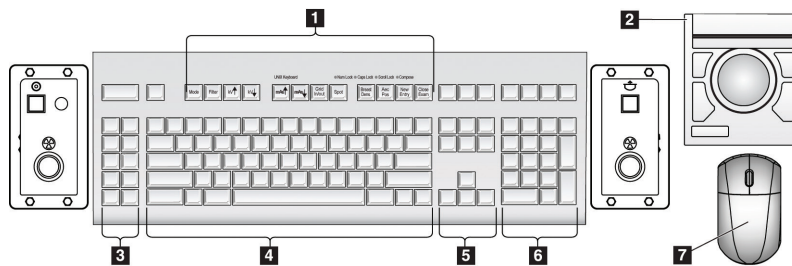

Figure 13: Selenia Keyboard

Figure Legend

1. Selenia Function keys
2. Trackball (Acquisition Workstation)
3. Future Use
4. Standard keyboard keys
5. Standard arrow keys
6. Standard number keypad
7. Mouse (Value Console)

3.4.4 Keyboard and Screen Controls

Use the trackball or the function keys to change Exposure techniques.

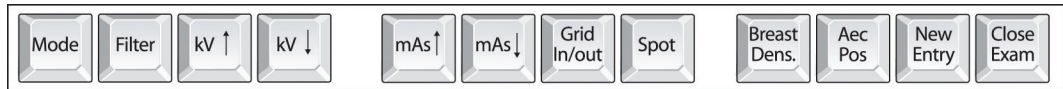













Figure 14: Selenia Function Keys on the Keyboard

Table 3: Selenia Function Keys

Key	Name	Function
	Exposure Mode	Changes AEC, TEC, and Manual exposure modes.
	Filter	Changes the Filters. The Filter options depend on the x-ray tube. The Molybdenum system has Mo and Rh. The Tungsten system has Rh and Ag.
	kV Up	Increases kV.
	kV Down	Decreases kV.
	mAs Up	Increases mAs.
	mAs Down	Decreases mAs.
	Grid	Changes the Grid Position (In or Out).
	Focal Spot	Changes the Focal Spot size (Small or Large).
	Breast Density	Changes the TEC Breast Density settings.
	AEC position	Moves the AEC Sensor position.
	New Entry	Opens the New Patient Entry dialog box.
	Close Procedure	Closes the Procedure. (Disabled when MPPS is installed).

3.4.5 Bar Code Scanner

The Bar Code Scanner speeds the entry of data from records with bar codes.

3.4.6 The Selenia Display

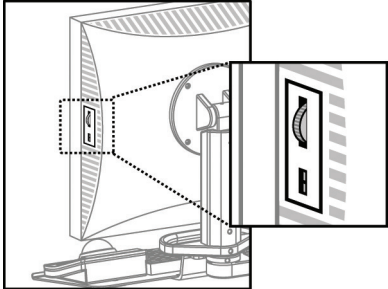
Features	Display
<ul style="list-style-type: none"> • Meets the DICOM requirements. • Press the recessed dial (on the right side) to show a menu. • Press and hold the recessed dial to turn the Display On/Off. • Green indicator lights when Display is turned on. • Ability to tilt. 	

3.5 Tubestand Controls and Displays

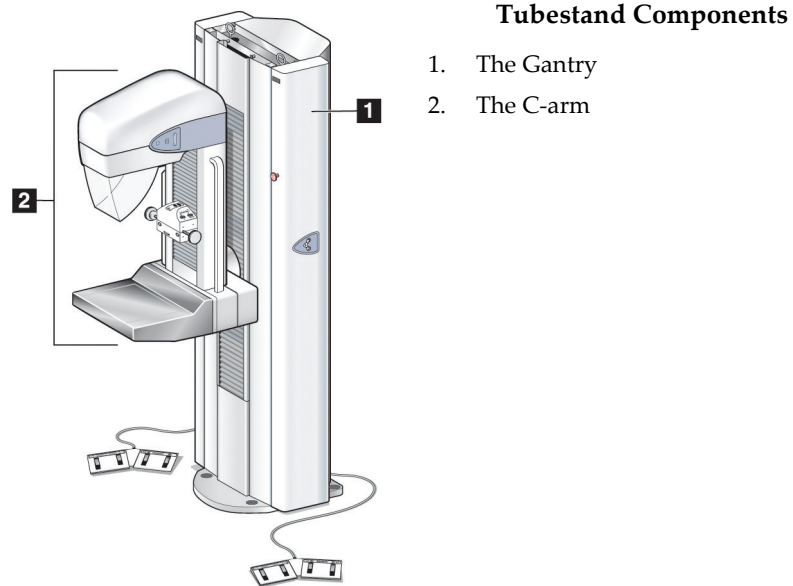

Figure 15: Tubestand

3.5.1 Gantry Controls and Displays

Gantry Controls

1. The C-arm Rotation Angle Displays on both sides of the Gantry show the C-arm angle.
2. The Emergency Off Switches on each side of the Gantry remove power from the Tubestand.
3. Gantry Rotation Switches (if installed) on each side of the Gantry move the C-arm to a programmed position.
4. The Input Power Circuit Breaker at the rear of the Gantry provides the overload protection.
5. Dual-Function Footswitches activate C-arm and Compression Device movement.

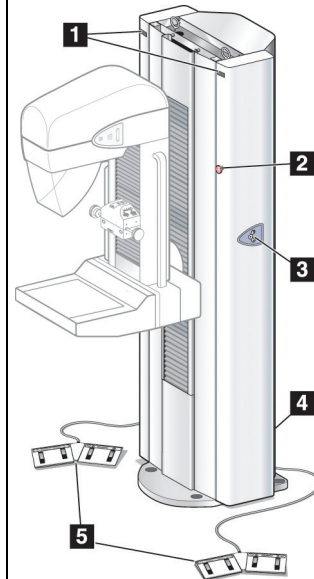
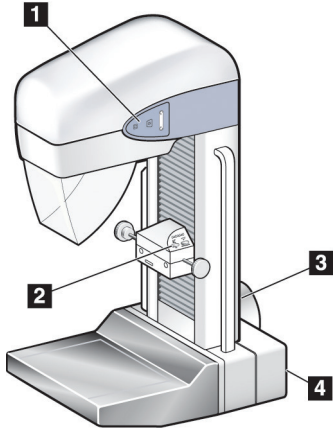
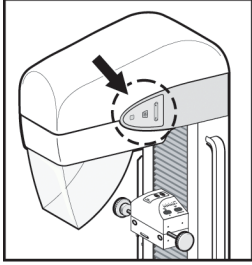
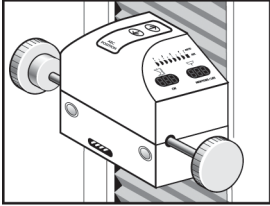
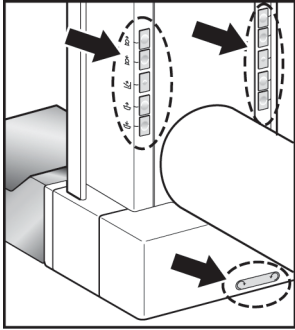

Figure 16: Gantry Controls

3.5.2 C-arm Controls and Displays

<p style="text-align: center;">C-arm Controls</p> <ol style="list-style-type: none"> 1. Tubehead Controls 2. Compression Device 3. Rear of the C-arm Side Rails 4. Rear of the Image Receptor 	
<p>The Tubehead Controls on either side of the x-ray tube side covers provide the Collimator Override, C-arm Rotation, and Light Field functions.</p>	
<p>The Compression Device contains the AEC Sensor control and position LEDs, and displays compressed breast thickness and force. Handwheels allow manual compression control.</p>	
<p>The rear edges of the C-arm Side Rail have recessed push-button controls for motorized compression and C-arm movement. An additional C-arm Rotation button is available on the rear of the Image Receptor.</p>	

Compression Device Controls and Displays

Figure Legend

1. Compression Handwheels
2. AEC Sensor Position Controls
3. AEC Sensor Position Display
4. Compression Force Display
5. Compression Thickness Display

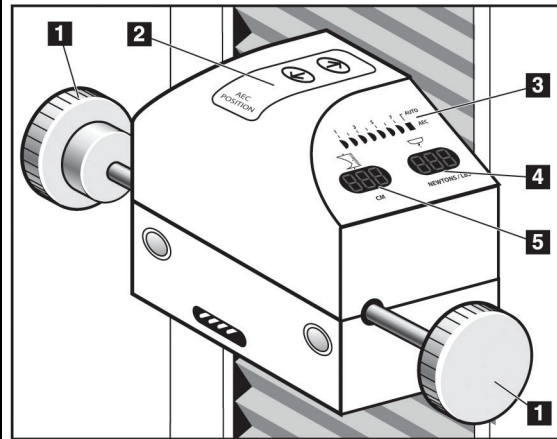

Figure 17: Compression Device

3.5.3 Dual Function Footswitches

1. Press the footswitch to activate.
2. Release the footswitch to stop motorized movement.

Figure Legend

1. C-arm Down
2. C-arm Up
3. Compression Down
4. Compression Up

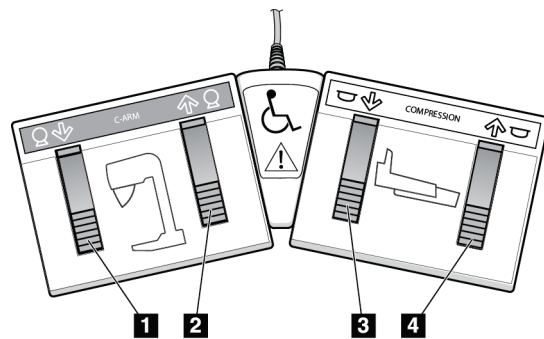

Figure 18: The Dual Function Footswitch



Warning:

Put the footswitches away from the patient and C-arm area to prevent any accidental footswitch operation. When the patient has a wheelchair, put the footswitches away from the area.

Chapter 4: Startup, Functional Tests, and Shutdown

4.1 Procedure for Startup

Table 4: System Startup Procedures

Step	Description
<p>1. Reset the Emergency Off Switches.</p>	<div data-bbox="1003 541 1162 695" data-label="Image"> </div> <p data-bbox="906 699 1268 730"><i>Figure 19: Emergency Off Switch</i></p> <ul data-bbox="755 768 1344 873" style="list-style-type: none"> • Two on the Gantry • One on the Acquisition Workstation (or Value Console)
<p>2. Make sure that the circuit breakers are turned On.</p>	<div data-bbox="914 919 1258 1073" data-label="Image"> </div> <p data-bbox="898 1077 1276 1108"><i>Figure 20: Gantry Circuit Breakers</i></p> <div data-bbox="800 1142 1372 1472" data-label="Image"> </div> <p data-bbox="808 1476 1365 1507"><i>Figure 21: Acquisition Workstation Circuit Breaker</i></p>
<p>3. Perform Pre-Startup Checks.</p>	<ol data-bbox="800 1560 1398 1839" style="list-style-type: none"> a. Look for open or loose panels, missing hardware, and indications of damage. b. Inspect the radiation shield for chips, cracks, breaks, and for tight attachments. c. Inspect the paddles for small cracks and wear. d. Remove any obstructions to the Operator view and C-arm movement.

Table 4: System Startup Procedures

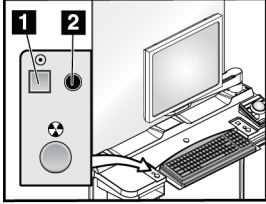
Step	Description
<p>4. Turn On the Selenia. (If the Acquisition Workstation does not start, reset the UPS for that unit. See How to Turn On or Reset the Uninterruptible Power Supply (UPS) on page 39.)</p>	<div style="text-align: center;">  <p>Figure 22: Power On Button and LED</p> </div> <ol style="list-style-type: none"> a. Press the Power On button (Item 1). The green LED (Item 2) illuminates. b. Allow the time for initialization and diagnostic tests to complete.
<p>5. Log on to the Operating System.</p>	<p>When the Logon dialog box appears:</p> <ol style="list-style-type: none"> a. Enter your user name (case sensitive) for the Operating System. b. Enter your Operating System password. c. Select OK or press the Enter key.
<p>6. Log in to the Application.</p>	<p>When the Login to System dialog box appears:</p> <ol style="list-style-type: none"> a. Select your ID from the drop-down list. b. Enter your password (case sensitive). (Asterisks appear in the field.) c. Select OK or press the Enter key.



Note

If the system remains on over the night, reboot the system daily to ensure best performance.



Note

If the system was turned off for 30 minutes or longer, the detector temperature needs time to adjust. Allow a minimum of 1 hour before you acquire images on a patient. The **Launch** dialog box disappears when the wait time is finished.

If it has been less than 30 minutes, click **Dismiss** in the **Launch** dialog box.



Note

If during the internal checks, the system detects a fault condition, a message appears and startup is suspended until the problem is resolved.

4.2 Controls and Functional Tests

Perform these functional tests monthly.



Note

The C-arm movement is disabled when compression force of 58 N (13 lb.) or greater is applied.

Table 5: Monthly Control Function Tests

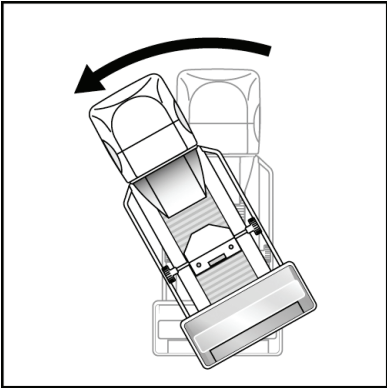
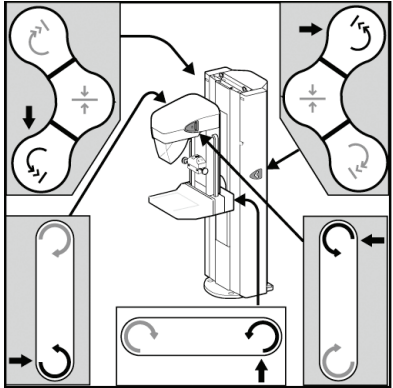
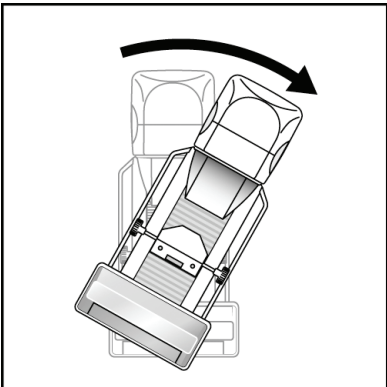
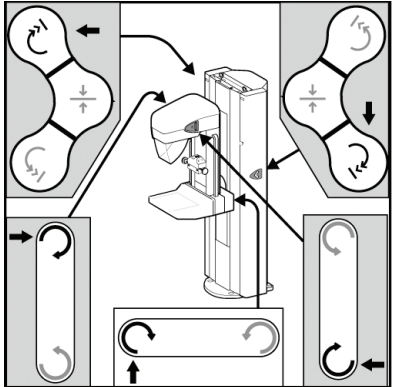
Function	Control	Test
<p>Counterclockwise C-arm Rotation</p> 	<p>C-arm and Gantry Rotation Switches</p> 	<p>Press and hold the C-arm button and confirm the following actions:</p> <ul style="list-style-type: none"> • C-arm rotates. • Angle display changes. • Rotation stops when you release the button. • Press and hold a Center button and confirm C-arm moves to zero degree position.
<p>Clockwise C-arm Rotation</p> 	<p>C-arm and Gantry Rotation Switches</p> 	<p>Press the button and confirm the following actions:</p> <ul style="list-style-type: none"> • C-arm rotates. • Angle display changes. • Rotation stops when you release the button. • Press and hold a Center button and confirm C-arm moves to zero degree position.

Selenia User Guide

Chapter 4: Startup, Functional Tests, and Shutdown

Table 5: Monthly Control Function Tests

Function	Control	Test
<p>Compression Down</p> 		<ol style="list-style-type: none"> 1. Press the button. 2. Confirm the compression brake engages and the light field lamp illuminates. 3. Confirm the Compression Down movement stops: <ul style="list-style-type: none"> • When you release the button. • At the compression down force limit. • At the lower compression travel limit.
<p>Compression Up</p> 		<ol style="list-style-type: none"> 1. Press the button. 2. Confirm the compression brake does not release. 3. Confirm the Compression Up movement stops: <ul style="list-style-type: none"> • When the Compression device reaches the upper compression travel limit. • On release of the button.
<p>Compression Release</p> 		<ol style="list-style-type: none"> 1. Press the button. 2. Confirm the following actions: <ul style="list-style-type: none"> • The compression motor brake releases. • The compression device lifts approximately 10 cm. <p><i>Note: The system disables all compression release functions when a localization paddle is installed, or system defaults are configured for manual compression release.</i></p>

Table 5: Monthly Control Function Tests

Function	Control	Test
<p>C-arm Up</p> 		<ol style="list-style-type: none"> 1. Press the button. 2. Confirm the C-arm Up movement stops: <ul style="list-style-type: none"> • When you release the button. • When the C-arm reaches the upper travel limit. 3. Apply more than 58 N (13 lb.) compression and confirm the C-arm does not move.
<p>C-arm Down</p> 		<ol style="list-style-type: none"> 1. Press the button. 2. Confirm the C-arm Down movement stops: <ul style="list-style-type: none"> • When you release the button. • When the C-arm reaches the lower travel limit.
<p>Light Field Lamp</p> 		<ol style="list-style-type: none"> 1. Press the button. Confirm the light turns on for a short time. 2. Confirm the light field lamp turns on when a Compression Down button is activated.

Selenia User Guide

Chapter 4: Startup, Functional Tests, and Shutdown

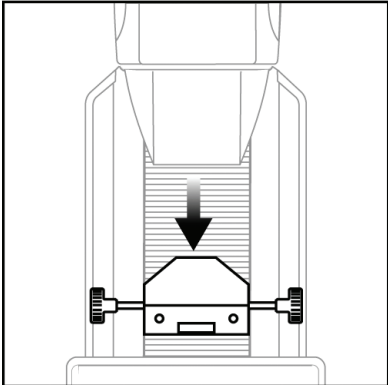
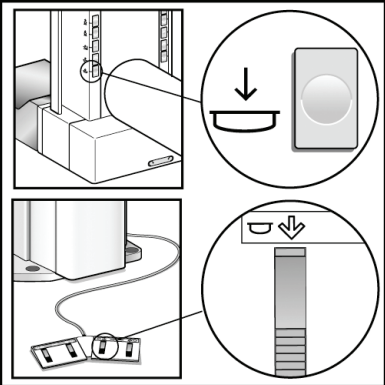
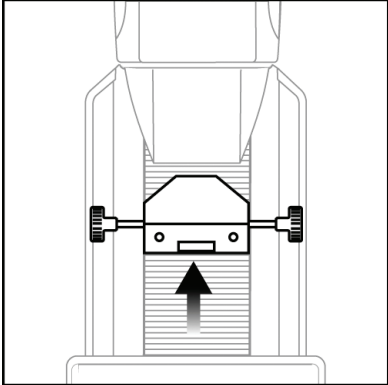
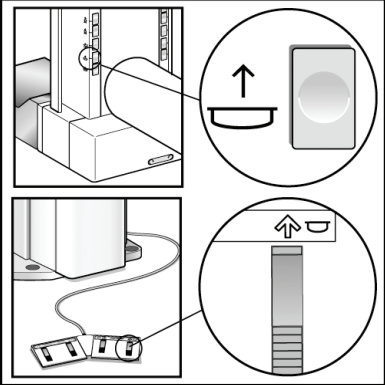
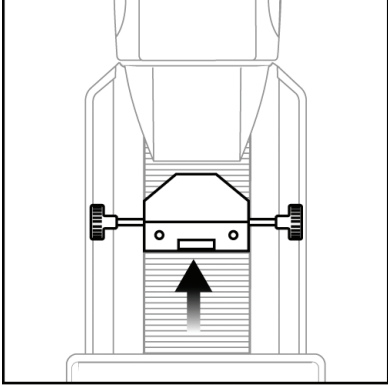
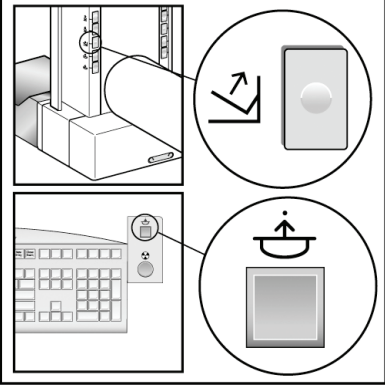
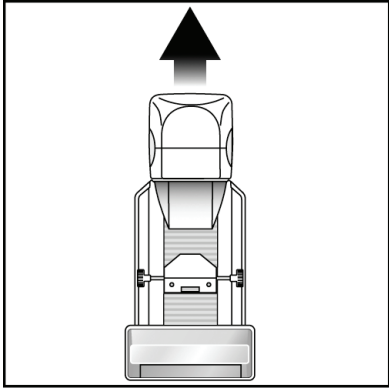
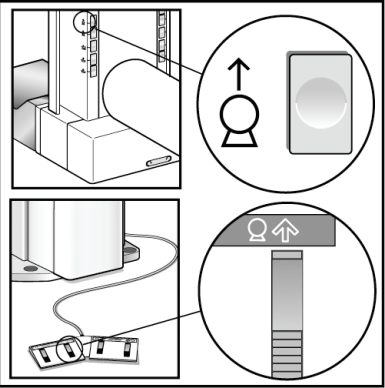
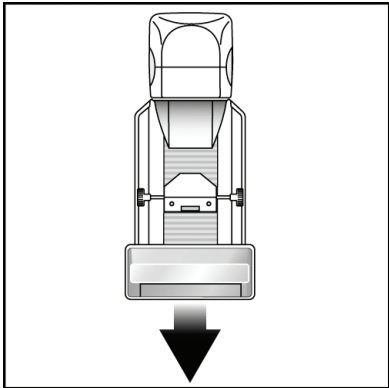
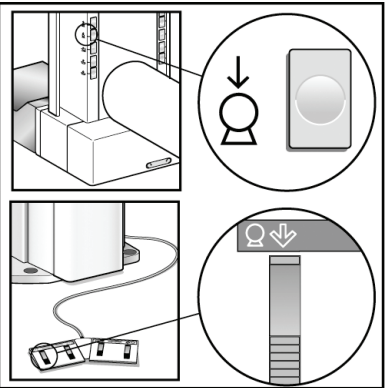
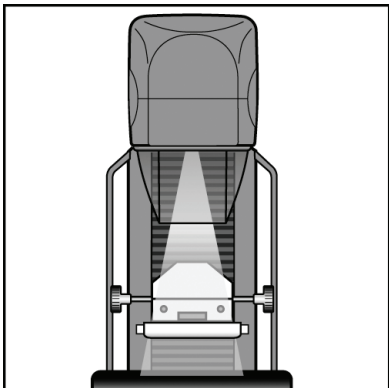
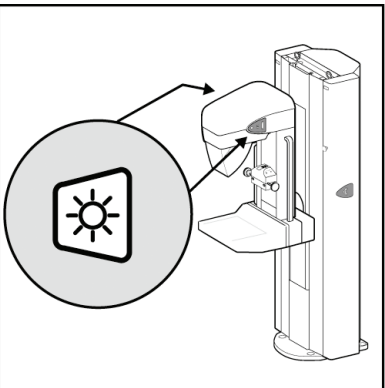
Table 5: Monthly Control Function Tests

Function	Control	Test
<p>Collimator Override</p> 		<ol style="list-style-type: none"> 1. Press the light field button then the collimator button. 2. Confirm the Collimator moves to the next field size. 3. Repeat the Steps 1 and 2 until you move through all Collimator field sizes.
<p>Smart Paddle</p> 		<ol style="list-style-type: none"> 1. Install a Smart Paddle. 2. Rotate the release knob on the side of the paddle from the lock to the shift position. 3. While you hold the knob in the shift position, move the paddle into a detent position. 4. Turn on the light field lamp. 5. Confirm the collimator position matches the paddle position. 6. Repeat this procedure for the other two paddle positions. 7. Apply compression and confirm the paddle does not unlock.

Table 5: Monthly Control Function Tests

Function	Control	Test
<p>AEC Position</p> 		<ol style="list-style-type: none"> 1. Select an AEC mode. 2. Change the AEC position with the compression device arrow button. 3. Confirm the indicator positions on the sides of the device and Acquisition Workstation display match the current position. 4. Move past position 7 or 1. 5. Confirm the Auto position indicator on the compression device illuminates and the display indicates Auto. 6. Select the AEC arrows on the display and repeat Steps 3 to 5. 7. Use the keyboard function key and repeat steps 3 to 5.

4.3 Monthly System Tests

- Test all Emergency Stop Switches. Follow the on-screen reset procedure.
- Change the AEC Sensor Position switch, and make sure the compression device indicator and the Acquisition Workstation display change.
- Test all buttons on all keypads and footswitches. Include the compression release on the Acquisition Workstation.
- During Compression Device tests make sure the thickness and force displays change.
- During C-arm rotation tests, confirm that the LED Angle displays change.

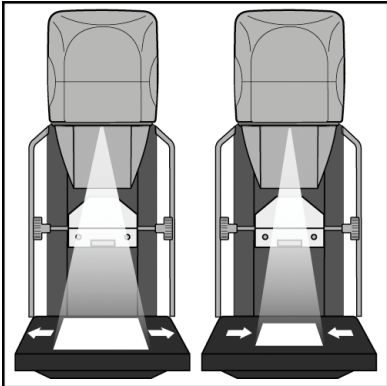
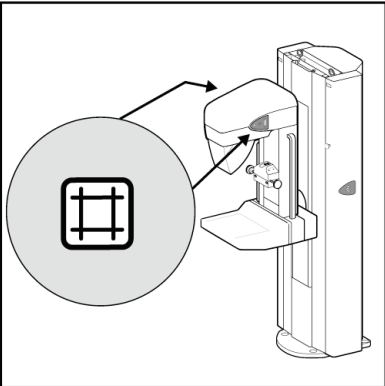
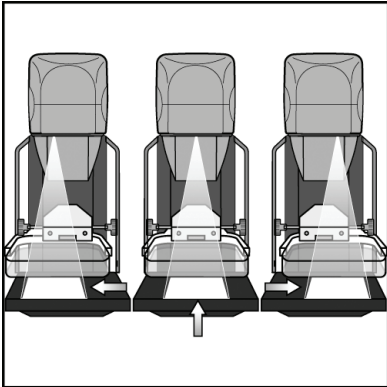
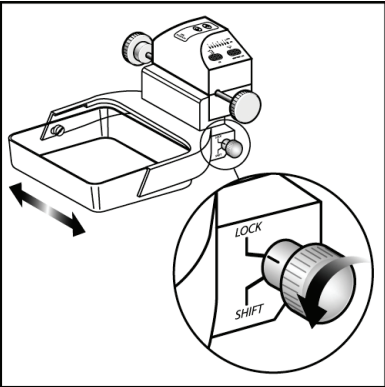
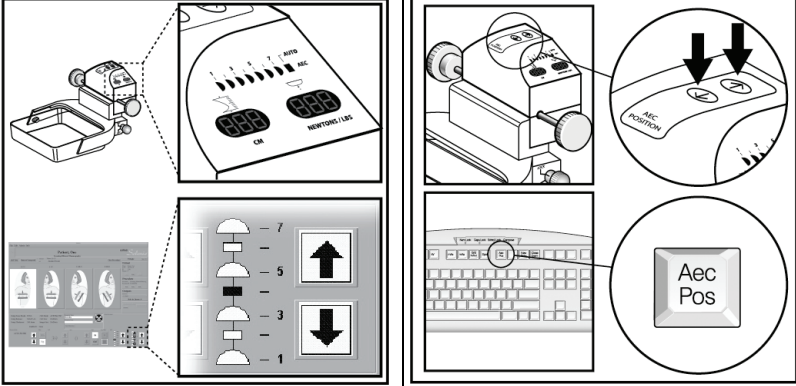
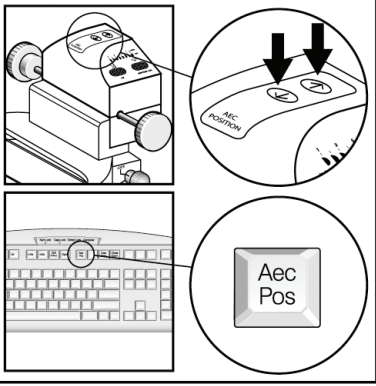
4.4 How to Restart the System

4.4.1 Restart From Sleep Mode

1. To activate the system, move the trackball or mouse.
2. In the Login dialog box, enter reboot for the user name and password.
3. Wait for the system to restart.
4. Log on to the Operating System, then Log on to the Application software.
5. If the system was off for less than 30 minutes, select **Dismiss** in the **Launch** dialog box.

4.4.2 Restart After the Emergency Off Switch was Activated

1. Turn the Emergency Off switch by one-quarter turn clockwise to reset the switch.
2. When the **Power Panel** dialog box displays, "**Communication with the generator is lost**," examine the Emergency Off Switches and the circuit breaker:



Caution:

Do not close this dialog box by using the X in the upper corner.

- If the Gantry power is turned on, select the **Cancel** button.
 - If the Gantry power is turned off, and the Emergency Off Switches and the circuit breaker are set correctly, select the **OK** button.
3. When the "**Link established with generator**" dialog box appears, select **OK**.

4.4.3 How to Turn On or Reset the Uninterruptible Power Supply (UPS)

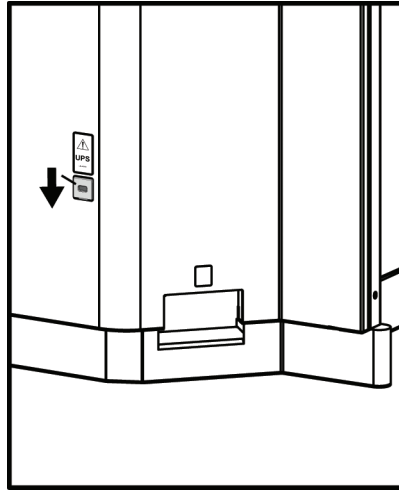

Figure 23: The Acquisition Workstation UPS Switch Lever

1. Find the Acquisition Workstation UPS switch lever on the lower, right of the back panel.
2. Press the switch lever down and hold for two seconds or until the UPS beeps.
3. Start the Acquisition Workstation.

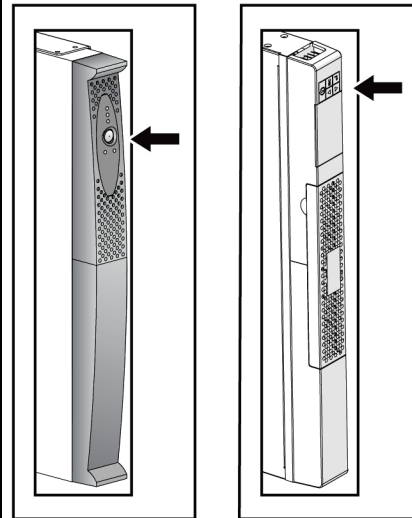

Figure 24: Value Console UPS Switch

1. Find the Value Console UPS switch, on the front of the UPS.
2. Press and hold the UPS switch for two seconds or until the UPS beeps.
3. Start the Console.

4.4.4 How to Turn Off the UPS

1. Make sure that the Acquisition Workstation or the Value Console are off. The UPS system begins to beep repeatedly and can now be shut down.
2. Find the UPS switch. (See the previous figures.)
3. For the Acquisition Workstation, press and hold the switch lever down for two or three seconds or until the UPS beeps. For the Value Console, press and hold the UPS switch for two or three seconds or until the UPS beeps.
4. When the power is restored, press the UPS switch one time to turn on the UPS.

4.5 How to Log Out

There are two methods to log out of the application. The system will remain on and another user can log in to use it.

Table 6: The Log Out Methods

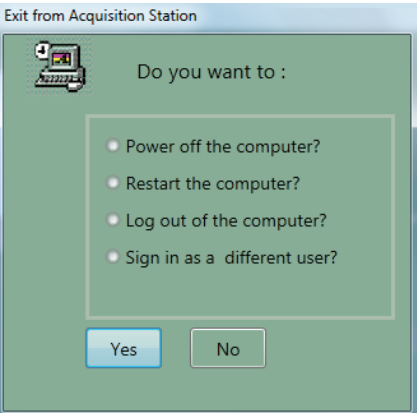
Method 1	Method 2
<ol style="list-style-type: none"> 1. Select the Sign Out button.  <p>Figure 25: The Sign Out Button</p> <ol style="list-style-type: none"> 2. Select the Exit button. 3. Select Yes. 	<ol style="list-style-type: none"> 1. Select File>Exit. 2. Select Log out of the computer?.  <p>Figure 26: Exit from Acquisition Station Dialog Box</p> <ol style="list-style-type: none"> 3. Select Yes.

4.6 How to Shut Down the System

1. Select **File>Exit**.
2. Select **Power off the computer?** from the dialog box. See the [figure Exit from Acquisition Station Dialog Box](#) on page 40.
3. Select **Yes**.



Note

If a message appears and indicates that there are spool jobs, select **log off** or wait until the jobs are finished. (The spool continues again later.) Hologic recommends that you allow the jobs to complete before shut down.



Caution:

Do not use a circuit breaker or Emergency Off switch as a routine method to turn off the Selenia.



Caution:

Never turn off the Acquisition Workstation or Value Console Circuit Breaker except in emergency. The circuit breaker can turn off the Uninterruptible Power Supply (UPS) and risk data loss.

Chapter 5: The Selenia Accessories

5.1 Patient Face Shield

Remember to examine the Face Shield condition before use each day.

5.1.1 How to Install the Face Shield on the Tubehead

1. Put the tab ends on the open end of the Face Shield into the slots on the tubehead mount.
2. Slide the Face Shield into the tubehead mount until the Face Shield locks in position.

5.1.2 How to Remove the Face Shield

1. Pull the rear sides of the shield away from the tubehead.
2. Slide the shield off the mount.

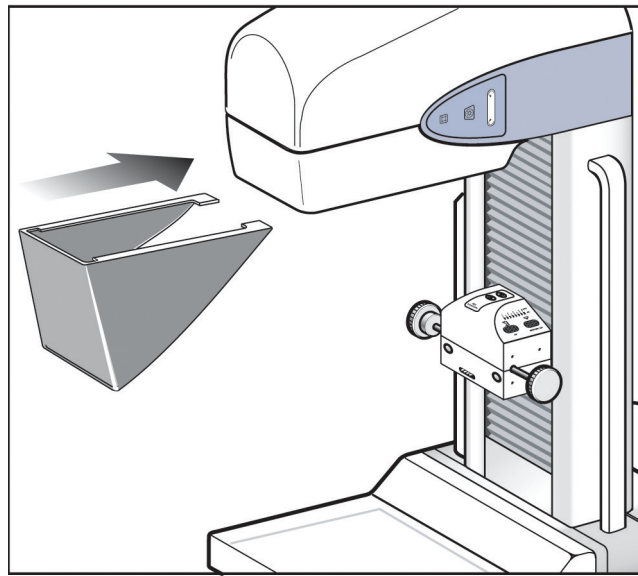

Figure 27: Installation of the Face Shield



Warning:

The Face Shield must be attached for all exposures except magnification case studies.



Warning:

The Face Shield does not protect the patient from radiation.

5.2 Compression Paddles

There are 19 compression paddles for Screening and Diagnostic Procedures. Twelve of the nineteen paddles are Smart Paddles and have mechanisms that allow manual lateral movement (both left and right). The x-ray collimation moves with the Shifting Compression Paddle position. The other seven paddles include five magnification paddles and two large 24 x 30 cm paddles.

5.2.1 How to Install the Compression Paddles

1. Align the mounting pins on the rear frame of the paddle with the mounting holes in the Compression Device.
2. Push the compression paddle into the Compression Device until the paddle stops.
3. Carefully pull the paddle out approximately 3 mm until the paddle clicks into position.

5.2.2 How to Remove a Compression Paddle

1. Hold the paddle by the metal sides of the frame.
2. Pull the paddle in a straight line from the mounting holes.

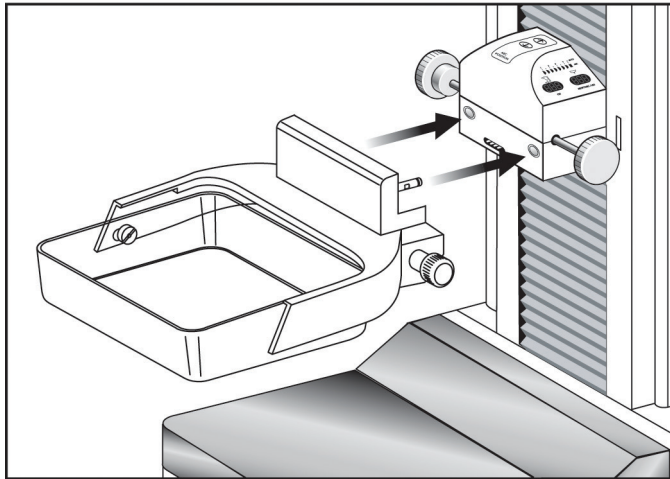

Figure 28: Mount the Compression Paddle

5.2.3 Maintenance and Cleaning

Clean the paddles after each use. See [Maintenance and Cleaning](#) on page 103 for cleaning instructions.

5.2.4 Smart Paddle System

A release knob on each side of the Smart Paddle allows it to move from one side of the image detector to the other. This enables the Technologist to optimize the breast position and imaging within the active area of the Image Receptor, especially when Lateral Views of a small breast are required.

To shift a Smart paddle:

1. Select a View on the Acquisition Workstation.
2. Rotate the release knob on the side of the paddle from the lock to the shift position.
3. While you hold the knob in the shift position, move the paddle to match the View. The paddle locks into position on a detent.
4. Release the knob to lock it in position.
5. Confirm the paddle is locked into position.
6. Activate the light field lamp and confirm the collimator matches the paddle position.

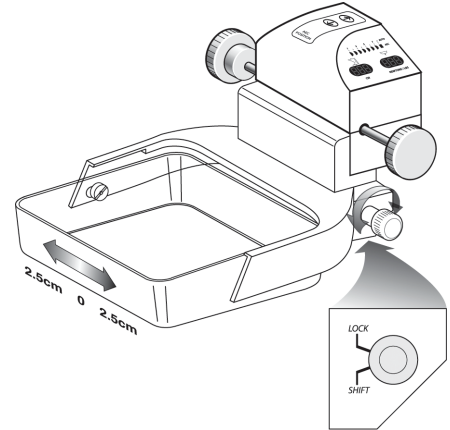

Figure 29: Shifting Compression Paddle

5.2.5 FAST Paddle Use

The Fully Automatic Self-adjusting Tilt (FAST) Paddle is for use when the composition of the breast tissue does not allow uniform compression across the complete breast with a flat compression paddle. For these patients, not enough compression can cause an image to appear to be out of focus at the anterior region from both involuntary motion and not enough compression.

The FAST paddle use with this type of breast provides these features:

- Reduced motion artifacts, because the compression is more effective.
- The compression is more uniform from the chest wall to the nipple.
- Maximum patient comfort, because over compression at the chest wall is prevented.

The FAST paddle automatically tilts when the compression is applied. The paddle is in a flat position until a compression force of approximately 20 pounds (88 Newtons) is applied. The paddle then tilts until its maximum angle is reached at a force of approximately 30 pounds (132 Newtons).

The FAST paddle does not require excessive compression, but you must use enough compression to prevent the movement of the breast. You should use a consistent amount of compression, especially for related left and right views.

The FAST paddle may not be best for breasts that are equal or symmetrical in thickness from the chest wall to the anterior area of the breast.

5.2.6 How to Realign the Paddle Front Edge

If the front edge of the paddle with 30 lb. (132 N) of compression force applied is not in alignment with the front edge of the Image Receptor, follow this procedure.

1. Release the compression and remove the paddle.
2. Loosen the hardware that holds the paddle to the frame. On a standard screening paddle, or a frameless spot paddle, turn the paddle upside down and loosen the hardware one complete turn. On a FAST paddle, use a hex wrench to loosen the paddle.
3. Turn the paddle over (if necessary) and loosen the two inside screws. See the [figure Alignment of Adjustment Screws](#) on page 44.
4. Install the paddle and apply 30 lb. (132 N) of compression force.
5. Move the paddle to the correct position. (Do not release the compression.)
6. Tighten both inside screws that you loosened in step 3.
7. Release the compression and remove the paddle.
8. Turn the standard screening or the frameless spot paddle upside down and tighten the hardware that fastens the plastic paddle to the frame.
9. Install the paddle and apply 30 lb. (132 N) of compression force.
10. Confirm that the front edge of the paddle is aligned to the front edge of the Image Receptor.

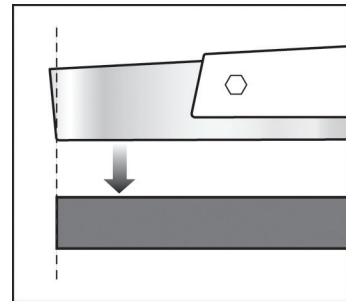

Figure 30: Alignment of the Paddle

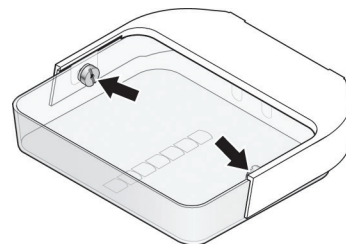
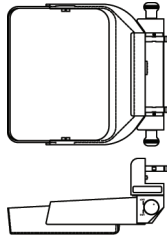

Figure 31: Alignment of Adjustment Screws

5.2.7 Identification of Compression Paddles

Routine Screening Paddles



18 x 24 cm Screening Paddle

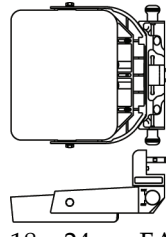

18 x 24 cm FAST Paddle

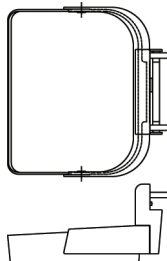

24 x 30 cm Screening Paddle

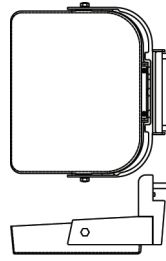

24 x 30 cm FAST Paddle

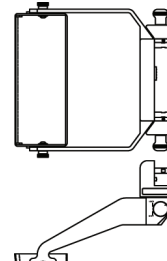

Small Breast Paddle

Contact and Spot Compression Paddles

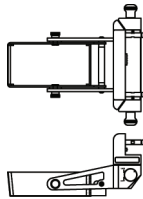

10 cm Contact Paddle

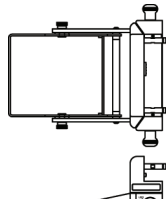

15 cm Contact Paddle

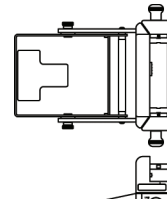

Ultrasound Paddle

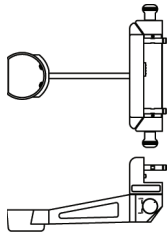

7.5 cm Spot Contact Paddle

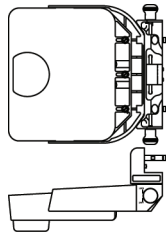

Frameless Spot Paddle

Magnification Paddles

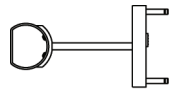

7.5 cm Spot Magnification Paddle

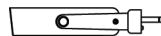
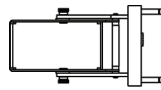

10 cm Magnification Paddle

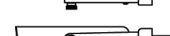

15 cm Magnification Paddle

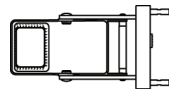

10 cm Magnification Localization Paddle

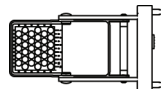

10 cm Magnification Perforated Localization Paddle

Use the Magnification paddles when the Magnification Platform is installed.

Localization Paddles

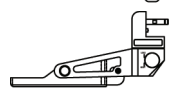
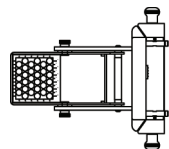

10 cm Perforated Localization Paddle

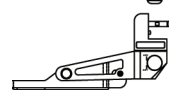
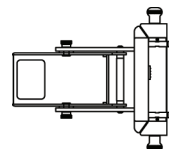

10 cm Rectangular Open Localization Paddle

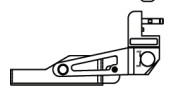
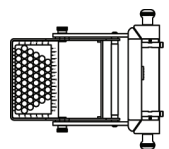

15 cm Perforated Localization Paddle

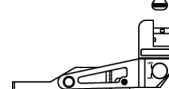
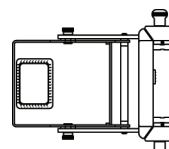

15 cm Rectangular Open Localization Paddle

About the Localization Paddles

The Installation method is the same for all Paddles. The system locks out Auto Compression Release when a Localization Paddle is installed. The AEC Sensor may require repositioning.

5.3 Magnification Platform

When the Magnification Platform is installed, the HTC grid automatically retracts and the default values for Magnification x-ray exposure techniques are set.

5.3.1 How to Install the Magnification Platform

1. Remove the Face Shield (see [Patient Face Shield](#) on page 41).
2. Remove the compression paddle.
3. Move the Compression Device above the slots in the C-arm.
4. Hold the Magnification Platform by the support brackets and align the hooks of the bracket with the mounting slots on the C-arm.
5. Put the hooks into the C-arm slots.
6. Push the frame down so that the clips lock the Platform in position.

When the platform is installed, you can use only the Magnification paddles. (See [Magnification Paddles](#) on page 46.)

5.3.2 How to Remove the Magnification Platform

1. Remove the Magnification paddle.
2. Press the locking clips on the Magnification Platform down to release the hooks.
3. Lift the Magnification Platform up and out by the support bracket.
4. Reinstall the Face Shield.

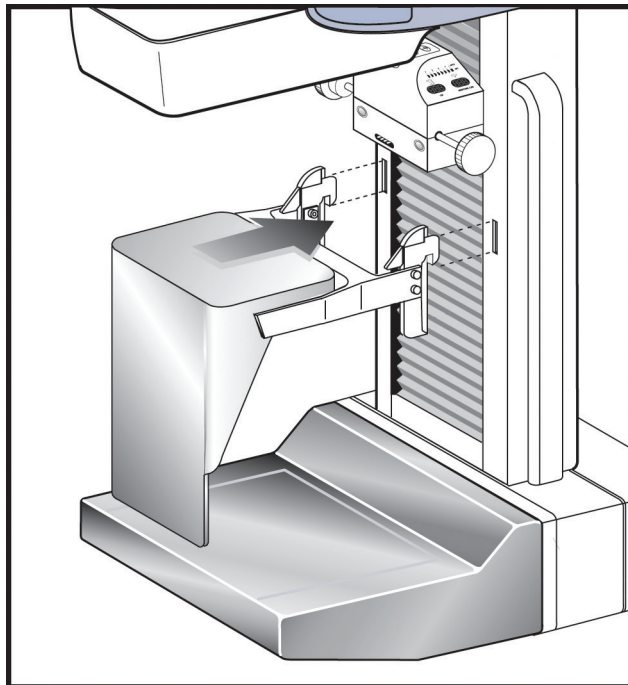

Figure 32: Magnification Platform Installation

5.4 The Localization Crosshair Device

The Localization Crosshair device, used with a localization paddle enables the location of a specified spot on the breast.

5.4.1 How to Install the Crosshair Device

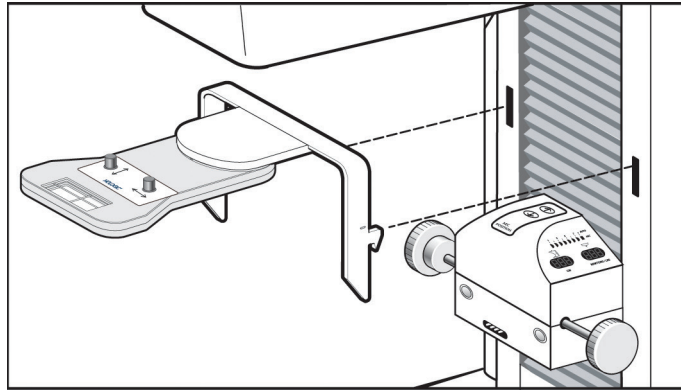

Figure 33: Installation of the Crosshair Device

1. Remove the Face Shield from the tubehead.
2. Move the Compression Device below the C-arm mounting slots.
3. Hold the Crosshair device by the support brackets and slide the hooks into the C-arm slots.
4. Push the device down to the locked position.
5. Install the Localization paddle on the Compression Device.

5.4.2 How to Remove the Crosshair Device

1. Rotate the Crosshair device to the left or right.
2. Press the two locking levers inside each mounting arm.
3. Lift the device up and from the C-arm. Be careful. The device is top heavy.
4. Install the Face Shield.

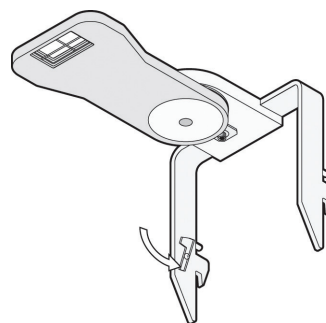

Figure 34: Crosshair Locking Levers

5.4.3 Localization Crosshair Device to the Localization Paddle Alignment



Note

Before you perform the following adjustment, make sure the Localization paddle is aligned to the edge of the image receptor. See [How to Realign the Paddle Front Edge](#) on page 44.

1. Install a rectangular localization paddle.
2. Loosen the adjustment lock screw on the bottom of the Crosshair Device. (See Number 1 in the image to the right.)
3. Put a piece of white paper on the breast tray so that you can see the shadows of the crosshairs.
4. Move the Localization paddle approximately 6 cm above the image receptor.
5. Turn on the light field.
6. Move the Crosshair Device until the rectangle of light aligns with the opening in the localization paddle.
7. Tighten the adjustment screw.

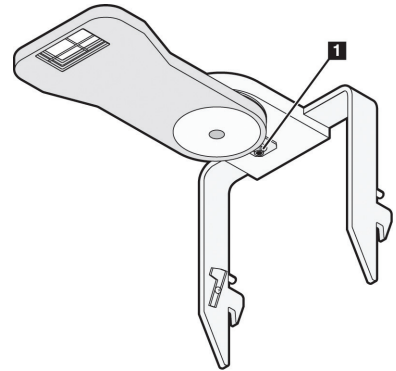

Figure 35: Adjustment Lock Screw

5.5 The Magnification Crosshair Device

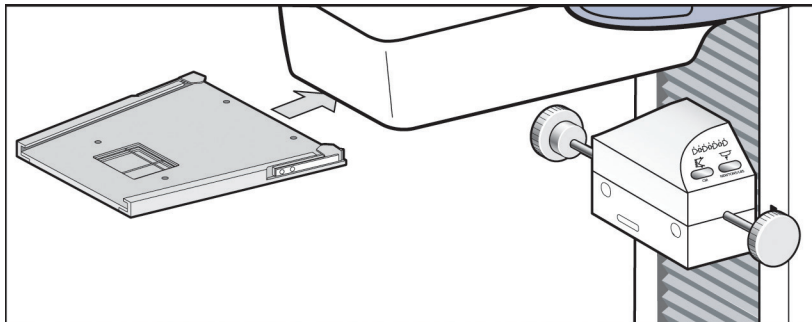

Figure 36: Installation of the Magnification Crosshair Device

1. Remove the face shield from the tubehead.
2. Align the Magnification Crosshair Device with the grooves of the face shield rails.
3. Push forward until the device locks into position.
4. To remove the Magnification Crosshair Device, pull and slide the assembly toward you.

Chapter 6: The User Interface

6.1 Introduction to the User Interface

The process of image acquisition, enhancement, and output is done through three screens:

- Select a Patient screen
- Patient Views screen
- Preview Images screen

When you select an option on a screen, other screens may appear for information entry or selection of additional options. This manual covers the screens that appear while you are logged in as a "tech".

- Select a Patient

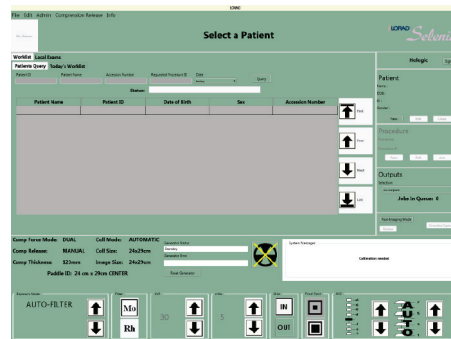

- Patient Views

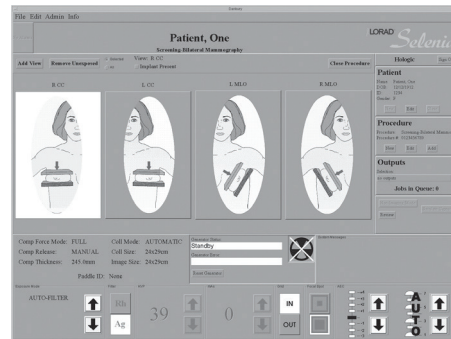

- Preview Image

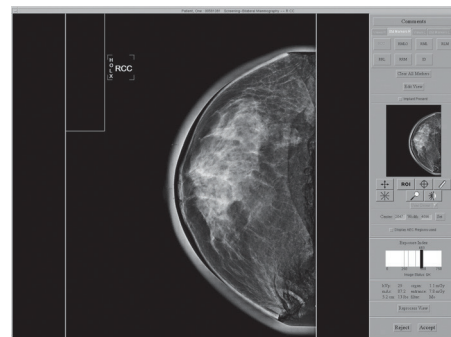

6.2 Select Patient Screen

6.2.1 Introduction

The Select a Patient screen appears when the system application loads. This screen allows you to locate a patient, and access non-routine Acquisition Workstation options with no patient selected.

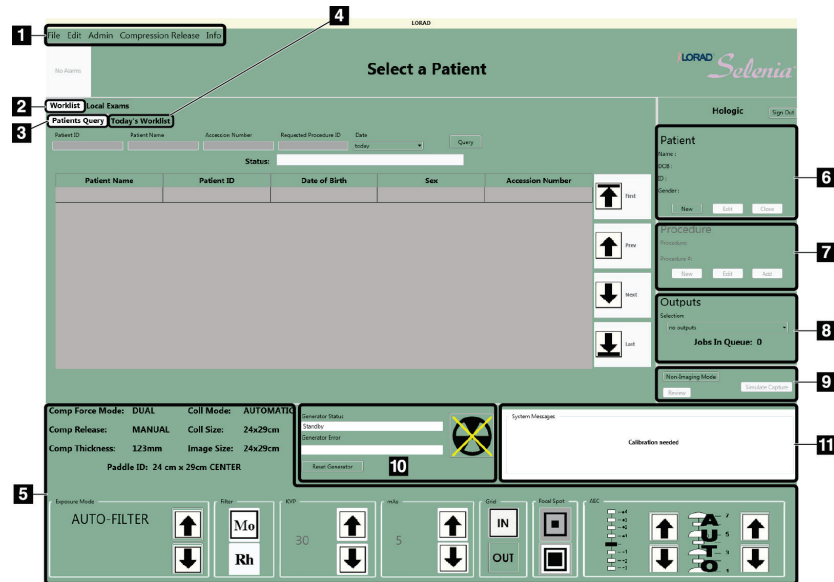

Figure 37: The Select a Patient Screen

Figure Legend

1. Menu Bar - [Menu Bar](#) on page 63
2. Search for a Patient - [Select a Patient](#) on page 53
3. Patient Query - [How to Search the Acquisition Workstation Database \(Local Exams\)](#) on page 53
4. Today's Worklist - [More Information about Searches](#) on page 53
5. Exposure Techniques - [Exposure Information](#) on page 58
6. Add/Edit the Patient Information - [How to Add a New Patient](#) on page 54
7. Add/Edit a Procedure - [New, Edit, Add a Procedure](#) on page 56
8. Outputs - [Image Output](#) on page 57
9. Special Modes - [Special Modes Buttons](#) on page 78
10. Generator Status - [Generator Status](#) on page 79
11. System Message - [System Messages](#) on page 79

6.2.2 Select a Patient

A patient can be added to the system or already exist and be selected from a list. There are two places to search for an existing patient, the worklist which is a list of scheduled patients from a Modality Worklist Provider and the Local Exams which are the patients on the computer in the workstation.

How to Query the Modality Worklist Provider

1. Select the **Worklist** tab in the upper left area of the Select a Patient screen.



Note

If you changed the date from the 'today' setting, select the **Today's Worklist** tab.

2. Enter the query data.

- If you use the Bar Code Scanner to input the query data, the procedure opens.
- If you use the keyboard to type the query data, select the **Query** button, then select the patient from the list to open the procedure.



Note

This query does not search the local Acquisition Workstation database, Local Exams. An Asterisk is not necessary for this search.

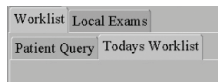

If your search for one match with a Patient ID or Accession Number has results, the patient Procedure opens automatically. Selecting a patient adds them to the Local Exams database.

How to Search the Acquisition Workstation Database (Local Exams)

1. Select the **Local Exams** tab in the upper, left area of the Select a Patient screen.
2. Select the **Patient Name** or **ID** tab.
3. Enter the Patient Name or ID in the Search box. Or, enter part of a Patient Name or part of an ID number and use an asterisk for the missing characters.
4. Select the **Search** button or press the **Enter** key.

More Information about Searches

- When part of the patient name is entered, the system applies a wildcard character at the end of the name.



Note

You can use the asterisk (*) as a wildcard character to increase your search. For example, when you enter R*ph, Patients with the names Randolph and Rudolph will display. If you use a wildcard character, make sure that you include a minimum of one other character.

- You can use one or more of the search fields.
- You can limit the query to a date range.
- Most worklist providers require information in the Patient ID and Accession Number fields to match. Data in these fields is case sensitive.
- You must include the caret (^) character between the name parts (for example, DOE^J).

6.2.3 How to Add a New Patient

The Patient area of the screen allows you to Add a New Patient.

1. Select **New** in the Patient pane to display the New Patient Entry dialog box.

Figure 38: New Patient Entry Form

2. Enter the Patient demographic information. Use the Tab key or the trackball to move through the fields. You must enter information in the Fields that have an asterisk.
 - The **Patient Name** fields must contain only letters or numbers.
 - The **Clear** button clears the information you entered.
 - The **Cancel** button closes the form without your changes.

3. Select the **Accept** button to enter the Patient in the Acquisition Workstation Local Database. The Patient Views screen displays.



Warning:

Verify the Patient Demographic Application information before you acquire an image.

6.2.4 How to Edit the Existing Patient Data

Figure 39: The Edit Patient Dialog Box



Note

This procedure only changes the patient information for images in the case study not yet taken. The Acquired images must be resent using Image Management and Resend, after the information is edited. See [Image/Spool Management](#) on page 70.



Caution:

Do not edit the patient information if you use a Modality Worklist. See About Patient Information Edits with a Modality Worklist and PACS.

To edit the Patient information:

1. Select **Edit** in the **Patient Box** to display the **Edit Patient** dialog box.
2. Make the changes to the fields that have wrong or missing information. Use the Tab key or the trackball to move through the fields.



Note

The **Cancel** button closes the dialog box without any changes. The **Clear** button clears last name, first name, DOB, and age.

3. Select the **Accept** button.
4. Verify that the correct changes appear in the screen before you acquire a new image.

6.2.5 New, Edit, Add a Procedure

How to Add a New Procedure

1. Open an existing patient.
2. Select **New** in the **Procedure** pane.



Figure 40: New Procedure, Edit a Procedure, and Add a Procedure Buttons

3. Select **Yes** in the **Creating a New Procedure will close the current Procedure** dialog box. Any open procedure will close.
4. When the **New Procedure** dialog box appears, enter a new **Accession** Number.

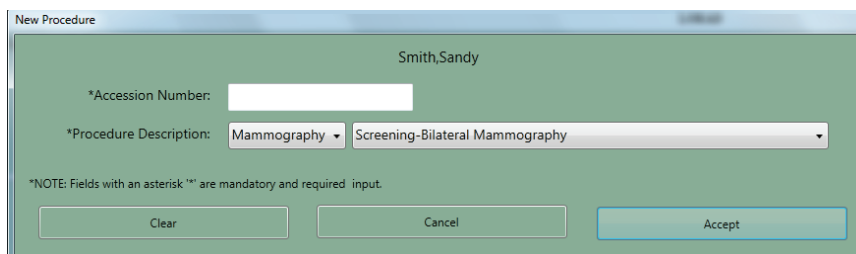

Figure 41: New Procedure Dialog Box



Note

The **Cancel** button closes the dialog box without any changes. The **Clear** button clears the Accession number.

5. Select the **Procedure Description** from the drop-down list.
6. Select the **Accept** button.

How to Edit a Procedure

1. Select the **Edit** button in the Procedure area of the screen.
2. Change the Accession Number. You cannot change the Procedure selection.
3. Select the **Accept** button.

How to Add a Procedure

The Add a Procedure function allows you to have many procedures open at the same time.

1. Select the **Add** button in the Procedure pane.

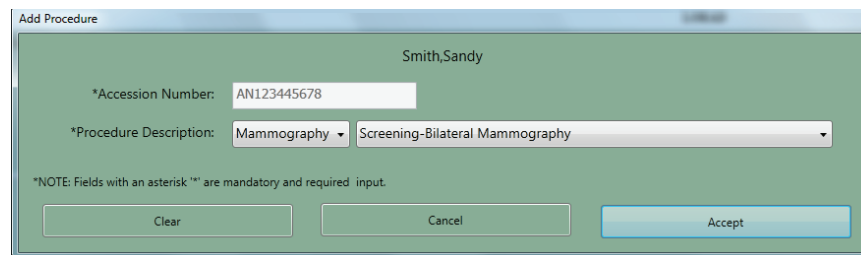

Figure 42: Add a New Procedure Dialog Box



Note

The added procedure must use the same Accession Number as the open procedure. If you do not plan to use the same Accession Number, select the **New** button and follow [How to Add a New Procedure](#) on page 56.

2. From the drop-down list, select the Procedure to add.
3. Select the **Accept** button.

6.2.6 Image Output

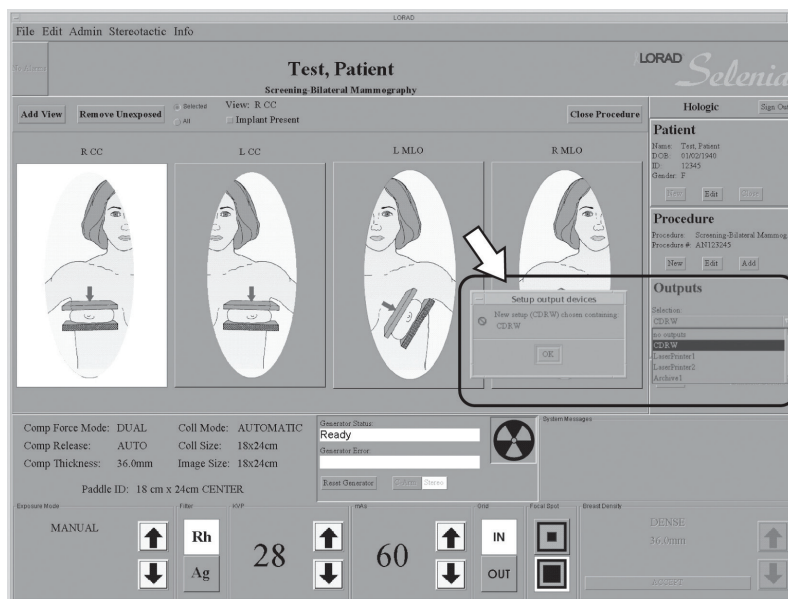

Figure 43: Select the Output

Before acquiring an image, verify that you selected the correct output. All patient images must be printed or committed to a PACS. Select the Output group to use for this procedure from the drop down list. To edit existing or create new output groups, see [Outputs](#) on page 67.

There is also a statement of the current number of Jobs in the Queue.

6.2.7 Exposure Information

The Exposure Pane

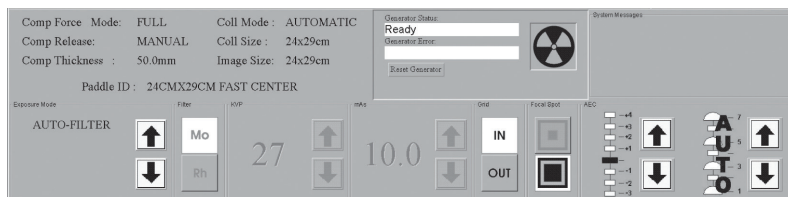

Figure 44: Exposure Techniques

The top, left side displays the status of these options:

- Compression Force Mode
- Compression Release
- Compression Thickness
- Collimation Mode
- Collimation Size
- Image Size
- Paddle ID (type and position)

Select the Exposure Techniques in the bottom area. Use the up/down arrows in the Exposure Mode area (the lower, far-left box) to select the Exposure Mode. The exposure default values for that mode appear to the right.

About Exposure Modes

Table 7: Exposure Modes

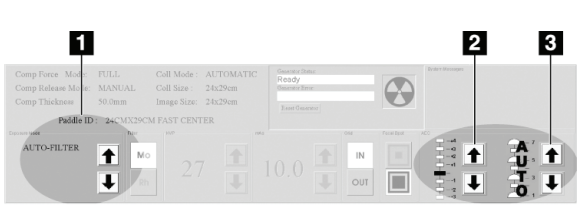
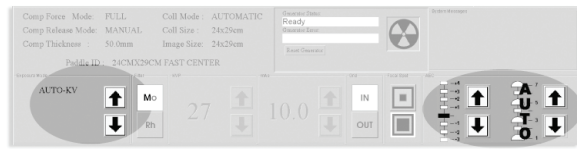
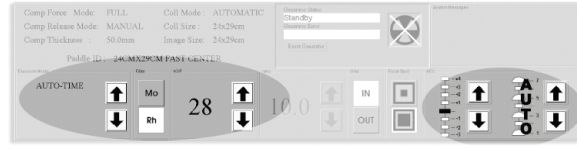
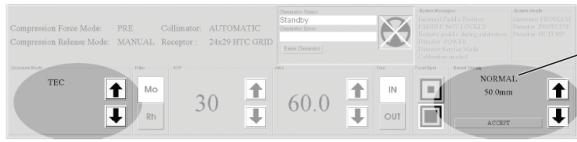
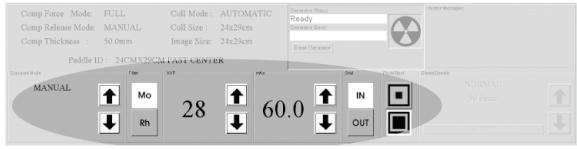
Exposure Modes (Item 1)	Operator Adjustments	Where the function is in the Techniques Pane
Auto-Filter	Select the AEC Exposure Adjustment (item 2); AEC Sensor (item 3) (Positions 1-7 or Auto).	
Auto-kV	Select AEC Exposure Adjustment; AEC Sensor.	
Auto-Time	Select kV; Filter; AEC Exposure Adjustment; AEC Sensor.	
TEC	Select Breast Density (item 4), then select Accept or change the Exposure Techniques, which puts you in Override (Manual) Mode.	
Manual	Manually calculate and select all x-ray techniques and Exposure Factors (kV, Filter, and mAs).	



Note

When you change the mode, all Exposure Techniques reset to the default values for that mode.

About the Manual Exposure Mode

In the Manual mode the Operator sets all Exposure Techniques. The default values appear when you select the View, then you make any necessary adjustment.

- To change an Exposure technique with the trackball, scroll to the value with the up/down arrows, or select the option box.
- To change an Exposure technique with the keyboard, press the Function Key for the item at the top of the keyboard.

About the TEC Exposure Mode

The Tissue Exposure Control (TEC) Mode is an enhanced Manual Exposure Control mode.

1. Before you position and compress the breast, select the **Breast Density** type on the Acquisition Workstation screen or press the **Breast Density** key.

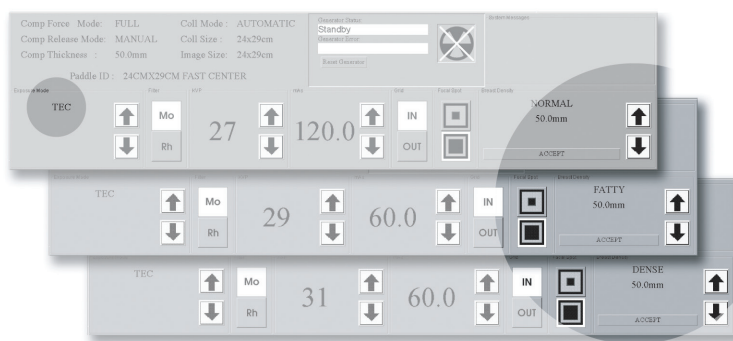

Figure 45: Breast Density Options

2. Compress the breast. The x-ray exposure techniques for kV, mAs, and filter update.
3. Select the **Accept** button in the Breast Density area (or press the **Enter** key). When "Ready" displays in the Generator Status message area, the system is ready to acquire an image.

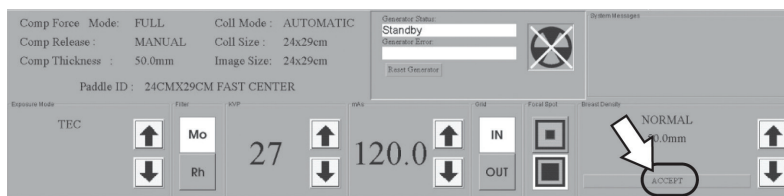

Figure 46: Accept TEC Exposure Techniques

If you change one or more of the parameters (kV, mAs, or filter), the system enters the Override Mode. When the Override message displays, the system is ready to acquire an image.

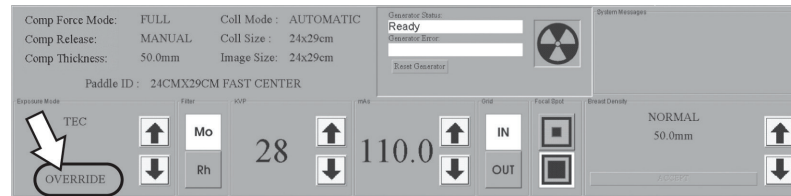

Figure 47: The Override Mode

There are three methods to exit the Override Mode and return to TEC mode:

- Change the Breast Density setting.
- Release the compression then compress the breast.
- Select TEC mode a second time.

AEC Exposure Mode

The Automatic Exposure Mode (AEC) uses the pre-exposure Scout pulse, and for some modes the compression thickness to calculate the exposure.

The AEC options are Auto-Filter, Auto-kV, and Auto-Time. See [About Exposure Modes](#) on page 59 for the exposure technique selections available with each mode.

AEC Exposure Adjustment Settings



Note AEC exposure adjustment is not available in all geographic regions.

You can use the AEC Exposure Adjustment controls to increase or decrease the target pixel value. Each step changes the target pixel value by approximately 15% and makes a related change in dose. See [figure AEC Exposure and Sensor Position Adjustments](#) on page 62.

Set this control in a range from +4 to -3 to increase or decrease the exposure. This adjustment remains until you change the adjustment or restart the system.



Warning: You increase the patient dose to high levels when you increase the AEC exposure adjustment. You increase the image noise or decrease image quality when you decrease the AEC exposure adjustment.



Warning: An increased exposure adjustment leads to a higher dose to the patient. Keep the patient dose as low as practical to get good image quality.

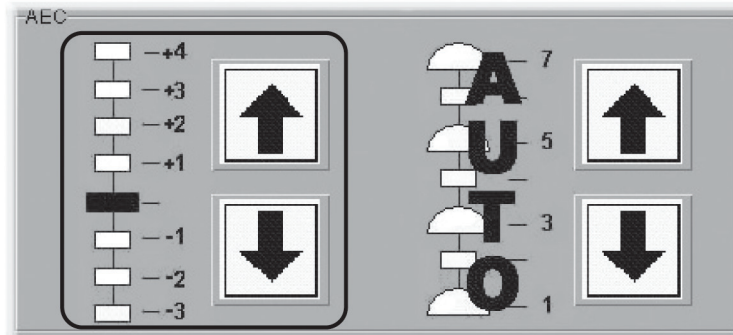

Figure 48: AEC Exposure and Sensor Position Adjustments

AEC Sensor Position Indicator Settings

Select one of the seven positions to indicate the area of interest for AEC calculations. Or, select Auto AEC where a larger area is tested.



Note

Always confirm the position of the AEC Sensor before an AEC exposure.

The AEC Sensor Position has eight available positions.

- The Positions 1 through 7 are manually selected, from the chest wall edge (position 1) to the nipple edge (position 7).
- Position 8 (Auto) automatically positions the sensor.

To change the AEC Position selection, use:

- The buttons on the compression device.
- The AEC Pos key on the keyboard.
- The AEC position arrows on the Acquisition Workstation display.

Set the AEC Sensor Position after you compress the breast. The displays on the side of the Compression Device and the lower right corner of the screen indicate the position setting.

AEC Alarm Messages

When the system cannot use the selected AEC mode to acquire an Image, one of the following messages displays.

Table 8: AEC Alarm Messages

Message	Reason and Corrective Action
Calculated Exposure Time Less Than Min	The AEC Sensor is over a thin or small area of breast tissue. Use the AEC Sensor in a position under the breast tissue. Alternately, use AutoTime and a lower kV.
Calculated Exposure Time Exceeds Max	Very dense breast tissue, an implant, pacemaker, or other anatomy changed the AEC sensor. Move the manual AEC sensor where there are no obstructions. Alternately, use AutoTime and a higher kV.

1. Select **OK** in the dialog box.
2. Select the **Reset Generator** button.

6.2.8 Menu Bar

The Menu Bar provides easy access to non-routine Acquisition Workstation options. These options are available while the Acquisition Workstation application runs unless a dialog box or Procedure is opened.

The table below shows the Menu Bar options when a patient procedure is *not* selected.

Table 9: Menu Bar Options and Functions

Menu	Options	Function
File	Exit	Exit from Acquisition Workstation
Edit	Standard Setup	Select the startup default values (Standard Setup Screens on page 65).
	View Order Editor	Change the view order (View Order Editor on page 66).
	User Setup	Add, edit, delete a user profile (Add or Edit a User on page 66).
	Outputs	Add, remove output devices (Outputs on page 67).
Admin	Image/Spool Management	Retrieve the images from the Image/spool (Image/Spool Management on page 70).
	Protect Patients	Protect or Unprotect patient records (Protect Patients on page 70).
	Manage Queues	Find a specified job in the queue (Manage Queues on page 71).
	Eject	Remove a disk from CD/DVD drive (Eject on page 72).
	Import	Copy images from a CD to the system (Import on page 72).
	Retrieve Priors	View previously-acquired images (Retrieve Priors on page 75).
	PPS Status*	Additional options (when MPPS Service is installed) for close of a procedure (MPPS Status on page 75).
	Calibrate	Access calibration procedures (Calibrations on page 76).
	Test Patterns	Access test pattern procedures (Test Patterns on page 76).
	DR Device Control	Access by Service personnel (DR Device Control on page 76).
	Available Disk Space	Displays status of hard disk drive space (Available Disk Space on page 77).
Stereotactic**	Enable or Disable Stereo mode**	Engage or disengage the stereo mode. Available when the StereoLoc II is installed.
Info	About the Acquisition Workstation	(Info Menu on page 77)

* This option appears when the MPPS Service is installed.

** This option appears when the Stereotactic Service is installed.

Edit Menu Function

Standard Setup Screens

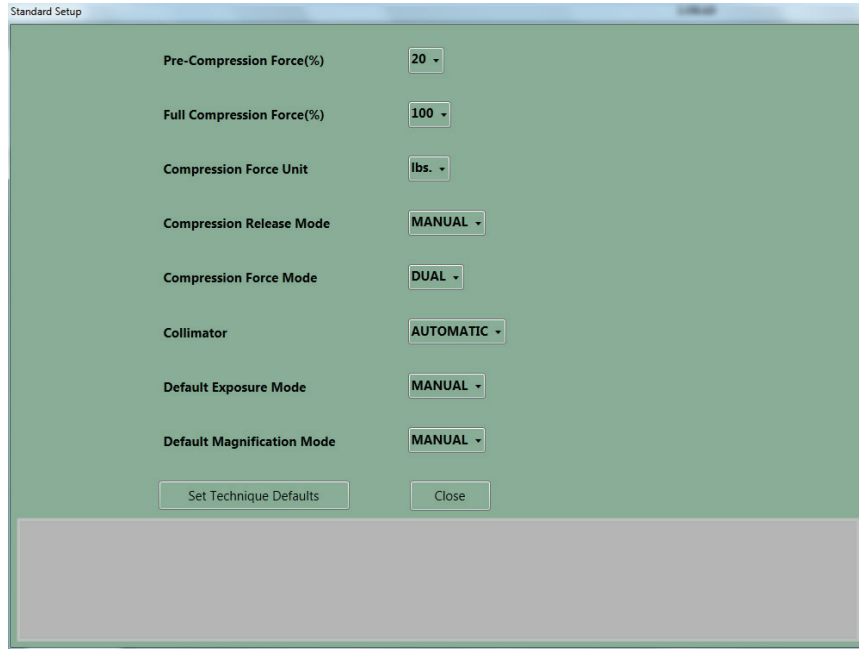

Figure 49: The Setup Screen

1. Select **Edit>Standard Setup**.
2. Use the trackball or the keyboard Tab key to move between fields.
3. Use the trackball or arrow keys to display and select options.
4. Select the **Close** button to exit the dialog box.



Note

When Manual Collimation is selected, the function that automatically changes the Collimation when a paddle is changed or moved turns off.

Set Technique Defaults

Select the **Set Technique Defaults** button to display the Technique Default Setup screen. You must set the default values for all modes.

1. Select **Manual** Exposure Mode and select the system startup defaults.
2. Change the mode to Auto-time and select the options.
3. Continue to change the mode and select the options for all remaining exposure modes including Magnification modes.

View Order Editor

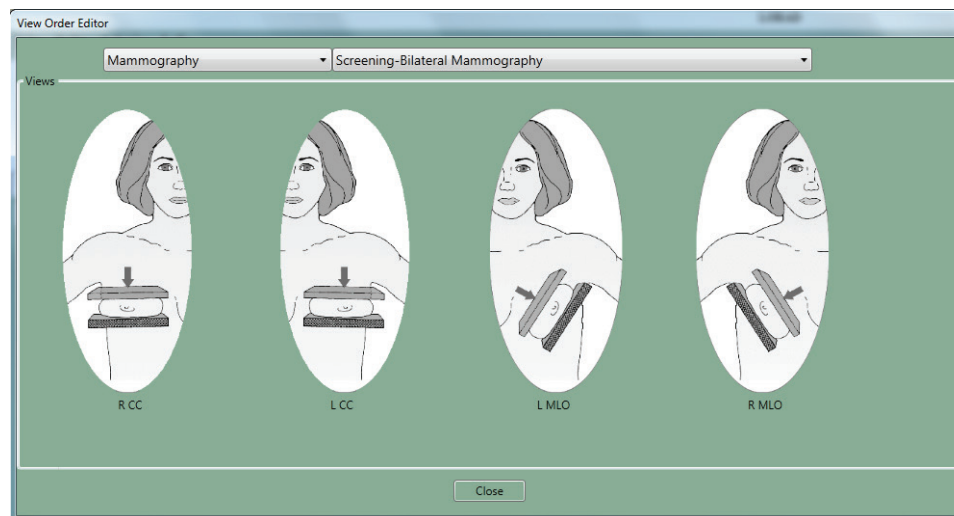

Figure 50: View Order Editor

1. Select **Edit>View Order Editor**.
2. Select the procedure from the drop-down menus.
3. Select the Views for each Procedure:
4. Left click and hold on the View icon to move and change the order.
5. Select **Close**. Your view order preferences load when you log in.

Add or Edit a User

A signed-in user can add or delete a user at the same or lower level. To access the Edit User options, select **Edit>User Setup**.

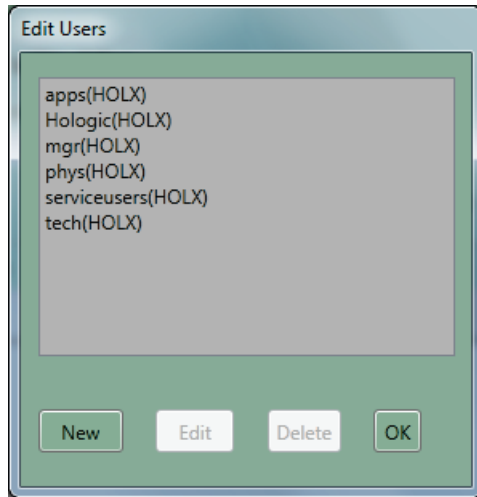

Figure 51: The Edit Users Dialog Box

Table 10: User Setup Options

Option	Steps
<ul style="list-style-type: none"> • Add a new user 	<ol style="list-style-type: none"> 1. Select New. 2. Enter the requested information. The password must contain a minimum of 6 characters. 3. Select the Accept button.
<ul style="list-style-type: none"> • Edit a user 	<ol style="list-style-type: none"> 1. Select your name from the list. 2. Select Edit. 3. Change the Initials, if necessary. 4. If requested, enter the Password. The password must contain a minimum of 6 characters. 5. Select the Accept button.
<ul style="list-style-type: none"> • Delete a user 	<ol style="list-style-type: none"> 1. Select the User to delete. 2. Select the Delete button. 3. Select the Yes button to the confirmation prompt.
<ul style="list-style-type: none"> • Close the dialog box 	<ol style="list-style-type: none"> 1. Select the OK button to close the Edit Users dialog box.

Outputs

To Add New Output Groups:

1. Select **Edit > Outputs**.
2. Select **New**.
3. Enter the name for this Output.
4. Select **OK**.
5. Select the new name in the **Edit Outputs** dialog box.
6. Select **Edit**.

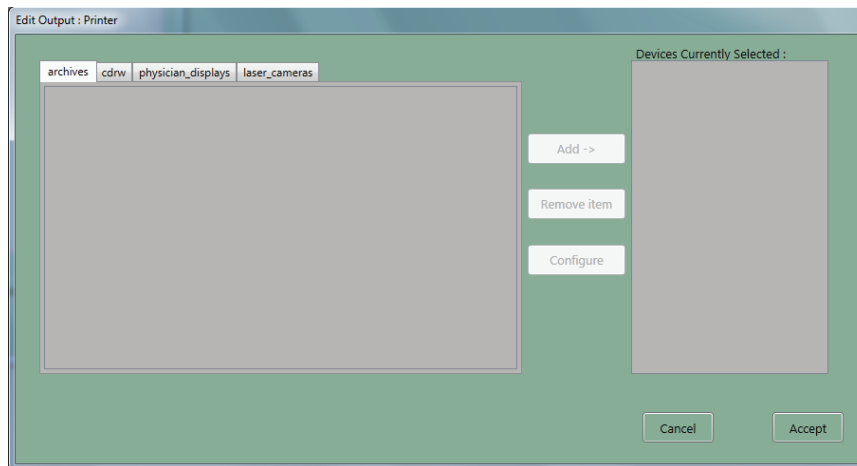

Figure 52: Edit Output Device Dialog Box



Note

Outputs are first created during installation.

7. Select the tab for the type of device.
 - CDRW = CD-RW
 - Laser Camera = Printer
 - Physician Display = Diagnostic Review Workstation, Technologist Review Workstation, CAD, etc.
 - Archive = PACS
8. Select the device name.
9. Select the **Add** button to move it to the right column.
10. To add another output device to the new group, select the tab for the device type.
11. Select the device name.
12. Select the **Add** button.
13. Select the **Accept** button when finished with the group.
14. Select the **OK** button.

To Edit Outputs:

1. Select **Edit > Outputs**.
2. Select an Output name. If the Output keeps its current name, go to step 7.
3. Select the **Copy** button.
4. Enter a new **Output name**.
5. Select the **OK** button.
6. Select the new name in the **Edit Outputs** dialog box.
7. Select the **Edit** button.
8. Select the tab for the type of device to add.
9. Select the device to add.
10. Select the **Add** button to move it to the right column.
11. Select the name of any output in the **Devices currently selected** column that is not needed in the group.
12. Select the **Remove Item** button.
13. Select the **Accept** button.
14. Select the **OK** button.

Admin Menu

Image/Spool Management

1. Select **Admin>Image Management**. The Choose a New Patient dialog box appears.

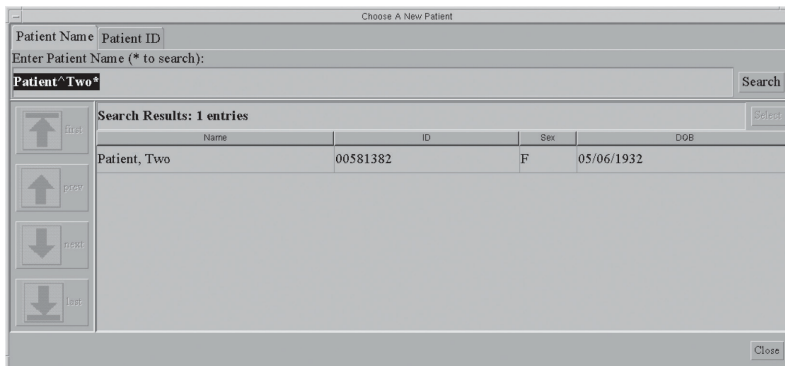

Figure 53: Choose a New Patient Dialog Box

2. Select the **Patient Name** tab or the **Patient ID** tab.
3. Enter the search information in the **Enter Patient Name** or **ID** box.
4. Select the **Search** button.
5. Select a patient from the list.
6. Select the thumbnail image of the image to resend or repreview.
 - You can select more than one to resend.
 - If there are more than four images, use the arrows on the side to scroll.
7. Select the Tab for **Repreview** or **Resend**.
8. Continue with directions in [The Resend Options](#) on page 73 or [The Repreview Option](#) on page 74.



Note

If the commit function is enabled and archive has committed the image to storage, the line "Commit: Accepted" appears in the information about the image in the upper right pane. See the [figure Image Management Resend Options](#) on page 74.

Protect Patients

Use the Protect function to prevent automatic removal of patient records from the hard drive.

1. Select **Admin>Protect Patients**.
2. Search for the patient to protect.
3. Select the patient to protect from the search results.
4. Select the **Protect** button at the bottom of the screen.
5. When the confirmation dialog box appears, select the **Yes** button.
6. Select the **Close** button.



Note

To create more space on the hard disk drive, unprotect patients who do not need protection.

To unprotect a patient record:

1. Select the patient.
2. Select the **Unprotect** button.

Manage Queues

Use Manage Queues to find problem jobs or a specified job in the queues.



Warning:

When you select Delete Job, the job is permanently deleted. If you did not send the job, resend it to a storage device later.

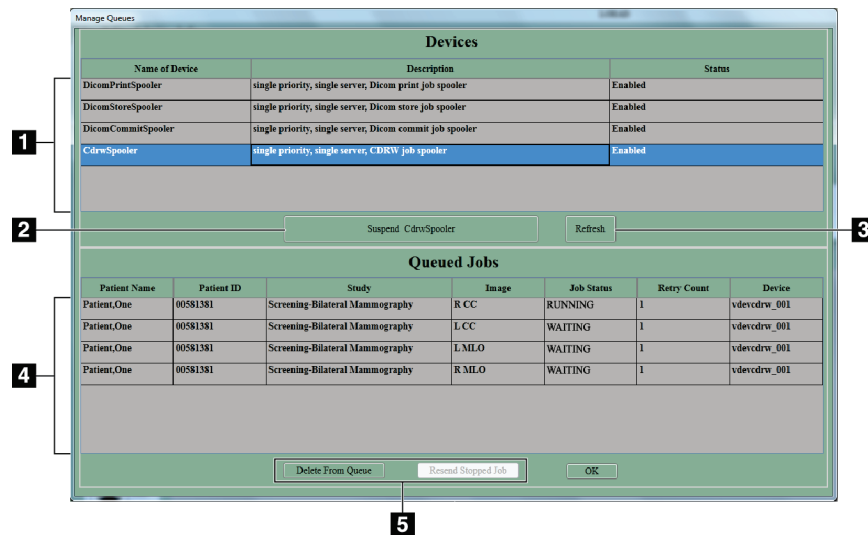

Figure 54: Manage Queues

Figure Legend

1. View the list of available queues.
2. Enable or disable a job spooler.
3. Update the list of Queued Jobs.
4. View the list of jobs in the queue.
5. Remove the inactive jobs from the queue. Resend stopped jobs.

Table 11: How to Use Manage Queues

Option	Steps
• To find the status of a job:	<ol style="list-style-type: none"><li data-bbox="737 390 1414 422">1. In the Devices list, select the queue to view.<li data-bbox="737 432 1036 464">2. Select the OK button.
• To delete a job:	<ol style="list-style-type: none"><li data-bbox="737 485 1198 516">1. Select the queue in the Devices list.<li data-bbox="737 527 1300 558">2. Select the Suspend <name> Spooler button.<li data-bbox="737 569 1414 642">3. Select a job from the Queued Jobs list, or Ctrl+click to select many jobs.<li data-bbox="737 653 1414 726">4. Verify that the selected job is the job to delete. There is no "undo".<li data-bbox="737 737 1227 768">5. Select the Delete from Queue button.<li data-bbox="737 779 1036 810">6. Select the OK button.
• To resend a stopped job:	<ol style="list-style-type: none"><li data-bbox="737 831 1198 863">1. Select the queue in the Devices list.<li data-bbox="737 873 1406 947">2. Select a job marked 'Stopped' from the Queued Jobs list, or Ctrl+click to select many jobs.<li data-bbox="737 957 1333 989">3. Verify that the selected job is the job to resend.<li data-bbox="737 999 1243 1031">4. Select the Resend Stopped Job button.<li data-bbox="737 1041 1036 1073">5. Select the OK button.

Eject

Select **Admin>Eject** to open the CD-RW drive drawer when there is a CD in the CD-RW drive.



Note

When the CD-RW drive is empty, press the button on the CD-RW drive to open the drawer.

When there is a disk in the drive, the drive drawer opens only from the menu. To close the drive drawer, press the CD-RW drive button.

Import

To import the information from a CD:

1. Open the CD-RW drive drawer.
 - Press the CD-RW drive button to open the tray if there is no CD in the drive.
 - Select **Admin>Eject** to open the drive if there is a CD in the drive.
2. Put the CD that contains the images to import on the tray.
3. Press the CD-RW drive button to close the tray.
4. Select **Admin>Import**.
5. In the dialog box, find the file (or files) to import.
 - Select a "+" to open a list of folders and/or files.
 - Select the empty box to select the file or folder.



Tip:

To deselect a file, click the checkmark. When you deselect a folder, the files below the folder are not deselected. You must clear each file.

6. Select the **Import** button. The file is copied from the disk and is available in the **Select a Patient** screen.



Note

Do Not press the **Eject** button on the drive while the system reads from or writes to the disk.

If you try to eject or read the CD while the import process finishes, you can cause the drive to stop.

The Resend Options

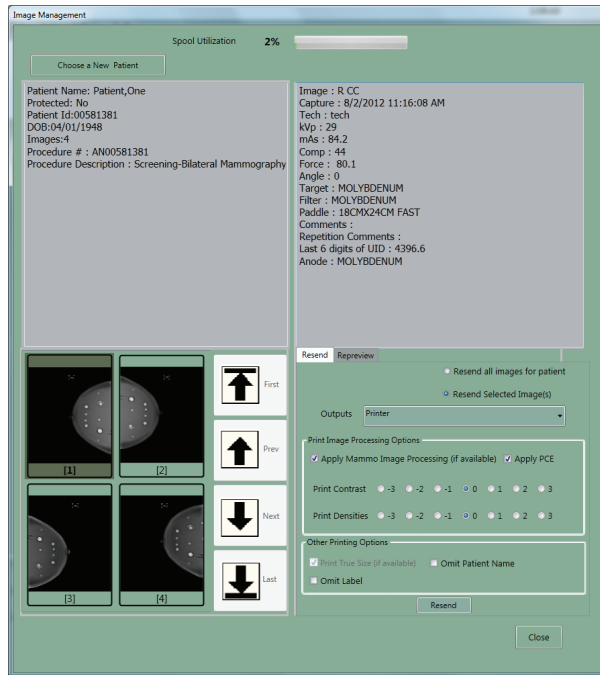

Figure 55: Image Management Resend Options

1. Select the **Resend** button.
 - To resend all images on the hard disk drive for this patient, select **Resend All Images**.
 - To resend selected images, select the thumbnails of the images to resend, then select the **Resend Selected** button.
2. Select the Output from the drop-down list.
3. If the selected Output has a printer, select the **Print Image Processing Options**.
4. Select the **Resend** button.
5. Select the **OK** button.



Note

You cannot change any patient or image object information from the resend function. This includes image, LUT modifications and DICOM information such as Patient name spelling, ID, and comments. To send new information you must make a new file with the Repreview function, save it, and Resend the new file.

The Repreview Option

1. Select the thumbnail image to review.
2. Select the **Repreview** tab, then select the **Repreview** button.
3. When you finish reviewing, select the **Cancel** button.
4. To create a new file to resend, make any required changes to the markers, comments, or use the **Edit View** function, then click **Save**. If you select a FOR PRESENTATION image, you cannot change the markers and ROI is not enabled.
5. Make any necessary changes in the **Contrast** or **Density**. These changes do not save when you save the image.
6. Select the **Save** button.



Note

Make sure that you send the newly-saved image. The original is a possible selection.

Retrieve Priors

To find the Images in the Local Database, select the Local Exams tab and search for the Patient.

To Retrieve Priors from the PACS system:

1. Select **Admin > Retrieve Priors**.
2. Enter the patient name in the **Name** field or ID in the **ID** field (wildcards allowed).
3. To limit the results to a date range, select the checkbox **Search by Date Range**, then enter the Date Range for the Prior Images. The date format must match the configuration setting, (mm/dd/yyyy or dd/mm/yyyy).
4. Select the **Query** button or press the **Enter** key. If the button is not enabled, you need more characters in either the **Name** field or **ID** field. Select the patient name (or names) to import.
 - You can select many patients.
 - You can deselect patients.
 - You can use the title bars to sort by field.
5. When the **Import** button activates, select **Retrieve and Import**. The images import into the Acquisition Workstation Local Database.
6. Select the **OK** button.
7. Select the **Close** button.

After the import completes, select the Local Exams tab to display the Patient Images. If there are more than 50 records in your query request results, adjust your search.

MPPS Status

When this optional feature is installed, a menu item is added to sites with the MPPS Service Class Provider. Workflow changes with three Close Procedure options instead of one option.

Calibrations

When Calibration is needed, the Select a Patient screen remains in Standby and the **Calibration Needed Alarm** message appears in the **System Message** box.

When you turn on the system, a message appears if the system needs any calibration. You cannot acquire the patient exposures until you perform the required calibration. All the review, resend, and administrative functions continue to work.



Caution:

It is important to follow the directions on the screen when you calibrate a system.



Note

Clean the detector and acrylic block before you perform a Calibration.

If you are in the Calibration Mode screen by accident, select the **End Calibration** button. If you started the Calibration, but you did not accept images, you can reject the Image and exit the Calibration.



Note

When you accept one image, do not end the calibration before you acquire, view, and accept all the images.

Test Patterns



Note

See DICOM Printer Quality Control in the Selenia Quality Control Manual for more information about the SMPTE test pattern.

1. Select **Admin>Test Patterns**.
2. From the **Output** area of the screen:
 - Select the Output **Device** from the drop-down list.
 - Select the Film **Size** from the drop-down list.
 - Uncheck the **Print True Size** check box.
3. Select the **Test Pattern** from the **Pattern** drop-down list.
4. Select from the options at the bottom of the screen:
 - To view the test pattern Full Screen, select the **Preview** button. To return to the dialog box, click any area on the Full Screen.
 - To send the Test Pattern to the selected output, select the **Send** button.
 - To remove any files from previous "sends" before you send the current images, select the **Clean Up** button.
 - To exit the Test Pattern option, select **Close**.

DR Device Control

This function is for use by service personnel.

Available Disk Space

This option displays the remaining number of images the hard disk drive and CD can hold.

The system automatically deletes some images/patients at specified levels to get back hard disk drive storage space for new procedures. Automatic image removal does not include the following:



Note

Your service representative can configure your system to auto delete rejected images from the Reject Bin. When auto delete is not configured, rejected images must be deleted manually.

- Images in a queue to an output device.
- Images for protected patients. (Make sure that you unprotect patients when you do not need their files.)
- Images that are not successfully committed to an archive device. (Archive devices send commitments after Images go to long-term storage.)



Caution:

If the disk does not have enough available space, the system does not acquire an image. A message displays the capacity of the disk. Delete unneeded images to restore the disk space.

Info Menu

The Info menu displays the information about the Acquisition Workstation.

Gantry Serial Number and Detector Temperature

To find the Gantry serial number:

1. Select the Info tab.
2. Select About the Acquisition Station.



Figure 56: Location of the Gantry Serial Number

6.2.9 Special Modes Buttons

Non-imaging Mode Button

The Non-imaging mode is available to all users and allows the x-ray exposure without the acquisition of images. This mode is not available when you have a patient selected. When you select the Non-imaging mode, the Image Receptor deactivates.

To access this mode, select the **Non-Imaging Mode** button.



Figure 57: Non-Imaging Mode Button



Caution:

Protect the Image Receptor from excessive radiation by covering it with lead while using the Non-imaging mode.

To exit the Non-Imaging mode, select the **End Non-Imaging Mode** button.

The Review Button

This button is used during the Reject /Unreject process. See [How to Accept a Rejected Image](#) on page 97.

The Simulate Capture Button

This function is for use by service personnel.

6.2.10 Generator Status

This area displays the current status of the system. See the [figure The Select a Patient Screen](#) on page 52.

6.2.11 System Messages

The System Messages area displays the system status.

6.2.12 Alarms

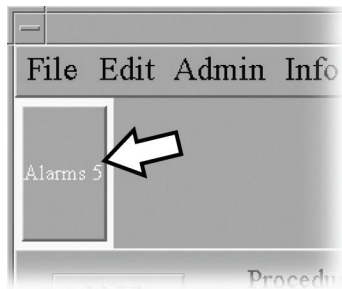

Figure 58: The Alarm Icon

Alarms are generally output problems that occur due to jobs that fail at the output device. The Alarm Icon shows the number of alarms. Select the icon to view the details. Erase the alarm to clear it.

6.3 Patient Views Screen

6.3.1 Patient Views

When you select a patient, the Views for the scheduled Procedure display on the Patient View screen in your preset order. The program automatically highlights the first View in the sequence. To choose a different View, select that View.

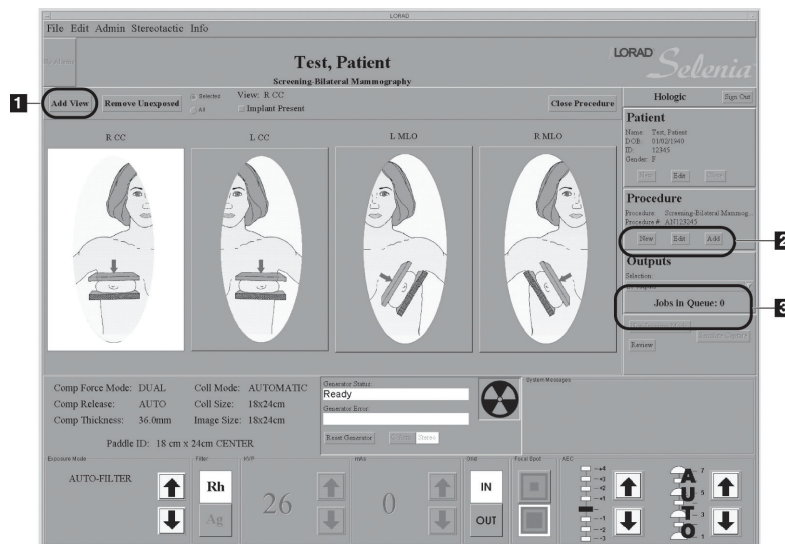

Figure 59: Patient View Screen

Table 12: Actions on the Patient Views screen

Topic	Information
Work with Views (item 1)	Work with Views on page 80
Add/Edit the Patient Information	How to Add a New Patient on page 54
Add/Edit a Procedure (item 2)	New, Edit, Add a Procedure on page 56
Select the Image Output	Image Output on page 57
Jobs in the Queue (item 3)	Displays the number of jobs in the outputs.
Change Exposure Techniques	Exposure Information on page 58
Acquire the View	Acquire Images on page 82

6.3.2 Work with Views

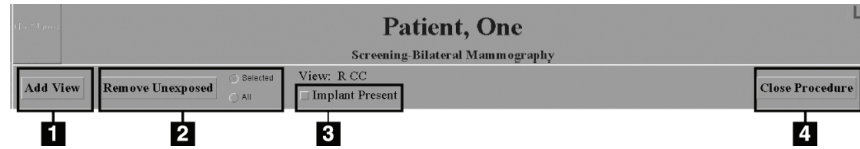

Figure 60: Buttons Used on the View Screen

Table 13: View Options

Option	Actions
Add View (item 1)	<ol style="list-style-type: none"> 1. Select the Add View button. 2. Select an additional View from the list of Standard Mammography Views. To add multiple views, hold down the Control key and select the View. 3. Select the OK button. 4. Select the new view icon before you acquire the image.
Remove Unexposed (item 2)	<p>Unused view icons are automatically reclaimed, but you can delete the views with the Remove Unexposed Views button.</p> <ol style="list-style-type: none"> 1. Select the All button to remove all unused icons, or the Selected button then indicate which views to delete. 2. Select the Remove Unexposed button.
Implant Present (item 3)	Select the box if there is an implant present in the breast. The box should remain checked for all views in the procedure.
Close Procedure (item 4)	<ol style="list-style-type: none"> 1. Select the Close procedure button. 2. Select the Yes button to close the procedure or the No button stay on the screen.

6.3.3 Acquire Images

The system is ready to acquire images when the Generator Status indicates "Ready" (item 1 in the figure below), and the X through the x-ray symbol (item 2, in the figure below) in the Generator Status box is not displayed.

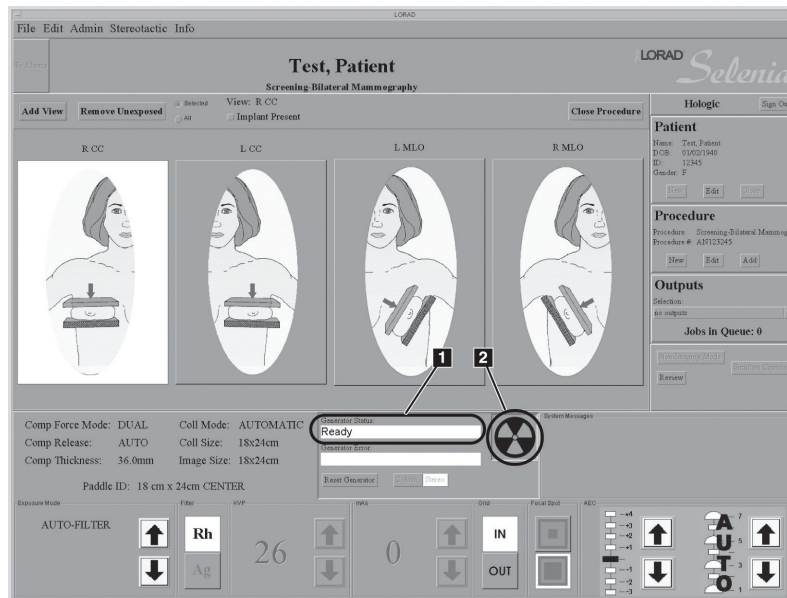

Figure 61: Ready for Exposure Indicators

6.4 Preview Image Screen

6.4.1 Introduction

The Preview Image screen appears when you acquire an image. The right side of the screen has image tools and buttons to Accept or Reject the image.

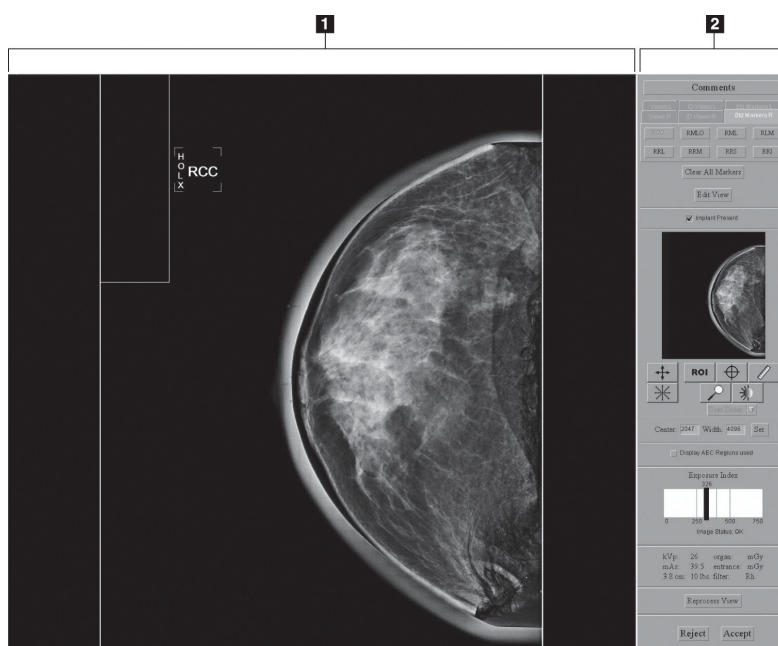

Figure 62: The Preview Image Screen

Figure Legend

1. Acquired Image Display Area
2. Tools

6.4.2 The Preview Image

The Preview Image is a non-diagnostic, processed image for anatomy and position confirmation. The Patient Name, ID, and the View appear on a bar on the top of the Preview.

Progressive Preview

The first preview image appears for a quick check of the breast position. This image updates with an image of better quality to check for motion or image artifacts.

Film Label Area

The film label area which is the small rectangle in the upper, left corner is blank in the Preview.

A Digital Marker next to the label displays the Technologist initials and the marker for the selected View. You can move or change the marker.

Hanging Options

The Images in this manual are displayed in the Dorsal orientation (the Operator faces the patient).

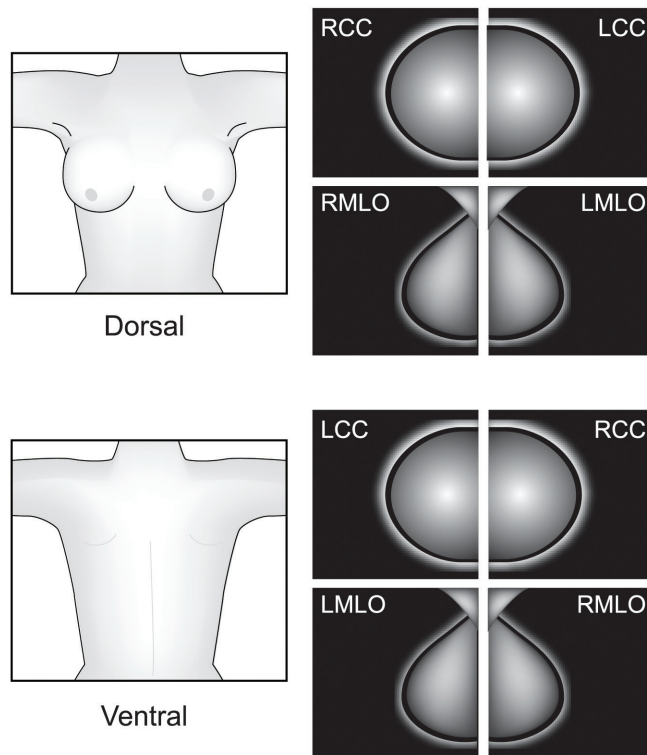

Figure 63: Hanging Options

This option can affect how images display on your diagnostic workstation. Confirm the effect of the options with the vendor.

6.4.3 Tools for Image Enhancement and Annotation

Figure Legend

1. Comments
2. Markers
3. Edit View
4. Implant Present
5. Zoom/Pan Thumbnail
6. Crosshair
7. Measurement
8. Window/Level
9. ROI size Drop-down
10. Set Center/Width
11. Display AEC Regions
12. Exposure Index
13. Exposure Techniques
14. Reprocess View
15. Magnification
16. Full Zoom/Pan
17. Quick Zoom/Pan
18. ROI

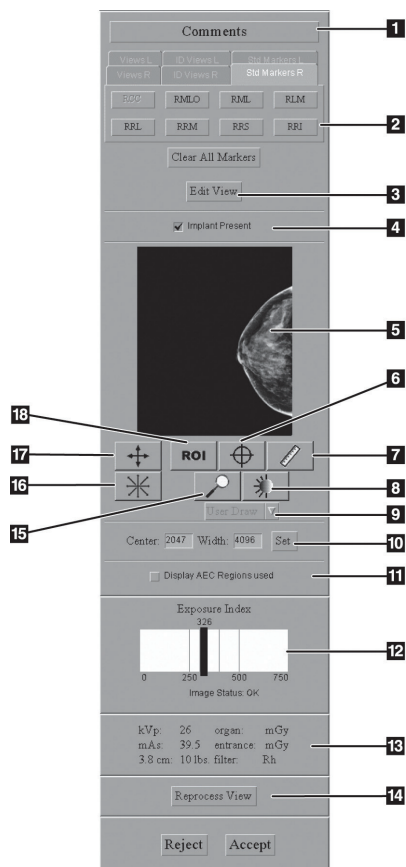

Figure 64: The Preview Screen Tools

Comments

The comment text is inserted in the DICOM header of the Acquired Image. The Diagnostic Review Workstation displays the comments.

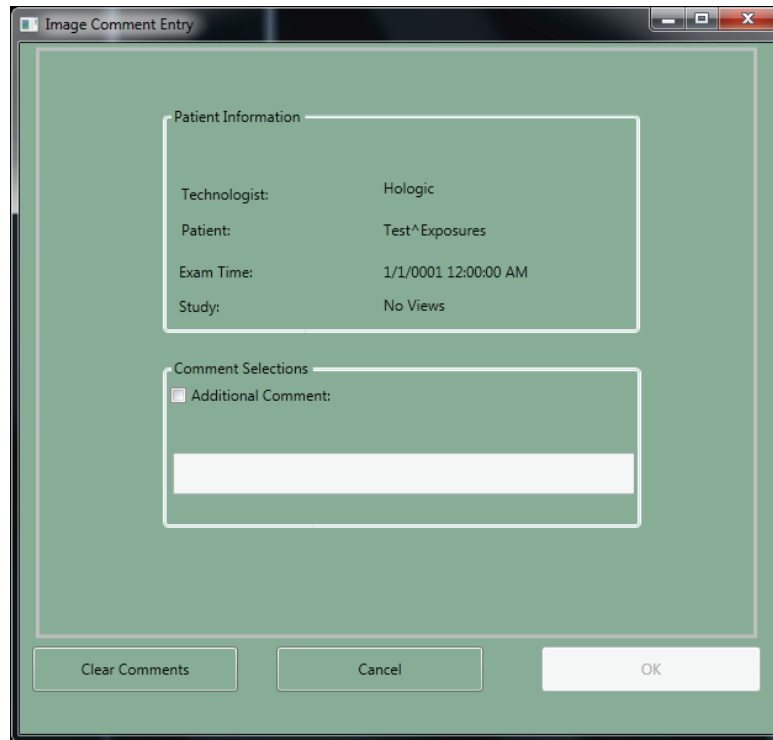

Figure 65: Image Comments

1. Select the **Comments** button.
2. Select the **Additional Comment** checkbox.
3. Select the field below the checkbox and enter your comment.
4. Select the **OK** button to save the comment.



Note

To remove all comments, select the **Clear Comments** button.
To close the dialog box without a change to the comments, select the **Cancel** button.

The Edit View Button and Markers

Select the **Edit View** button to update the DICOM header and enable the image to hang correctly at the Diagnostic Review Workstation.

The tabs and buttons allow you to change just the Marker.



Figure 66: The Markers in the Preview Pane

How to Use the Marker Function

1. If the marker is wrong, select the **Clear All Markers** button
2. Select the Tab for the set of markers you need.
3. Select the marker you need. You can select a maximum of three markers from the available set for each image.
4. Move the marker to the correct position.

If you change a Marker, you change the label on the image, but not the DICOM header. You will not see the change on the Patient View page.

How to Use the Edit View Button Before You Accept the Image

1. Select the **Edit View** button.
2. Select the required view from the displayed list.
3. Select **OK**. The correct image displays on the preview screen and the marker and the direction the image hangs are correct.

How to Use the Edit View Button After You Accept the Image

If the image is Accepted before you notice the wrong view, the incorrect image was sent to the selected output. Make the corrections, then resend the corrected image with the Image or Spool Management menu. See [Image/Spool Management](#) on page 70.

1. Before you make any changes:
 - If you printed the mislabeled image, find and discard that image.
 - If the image was sent to a Diagnostic Review Workstation, delete the mislabeled image.
 - If the image was sent to the PACS, tell the PACS administrator to delete the mislabeled image.
2. Repreview the Image. (See [The Repreview Option](#) on page 74.)
3. Select the **Edit View** button on the Preview screen.
4. Select the required view from the displayed list.
5. Select **Save**. A new thumbnail image appears. Resend this image.

Implant Present

Select the checkbox on the Patient View screen when an implant exists. When the checkbox is selected, the system marks future images with an Implant Present label. The checkbox on this screen enables you to change the selection before you accept the image.

Quick Zoom/Pan



Quick Zoom/Pan is active after the image is first displayed, before image processing completes.

1. Select the **Quick Zoom/Pan** button.
2. To pan through the image, drag with the right trackball or mouse button.
3. To turn off the function, select the **Quick Zoom/Pan** button.

Full Zoom/Pan

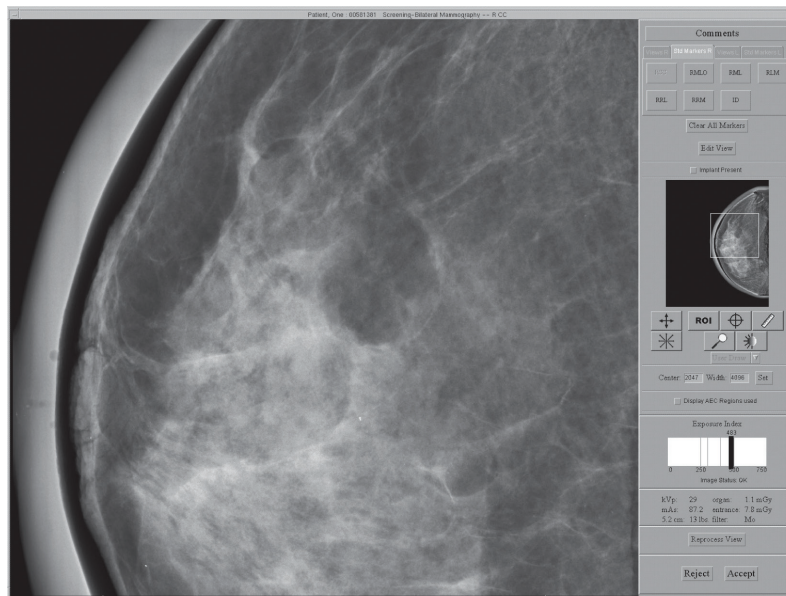

Figure 67: Full Zoom/Pan Image



The Full Zoom/Pan function becomes available after image processing is complete. The box in the thumbnail image on right side of the screen shows where the magnification view is in the complete image. With a left click, you can move this box in the thumbnail to view any area in the image.

1. Select the **Full Zoom/Pan** button.
2. To move through the image, drag with the right trackball or mouse button.
3. To turn off the function, select the **Full Zoom/Pan** button again.

ROI

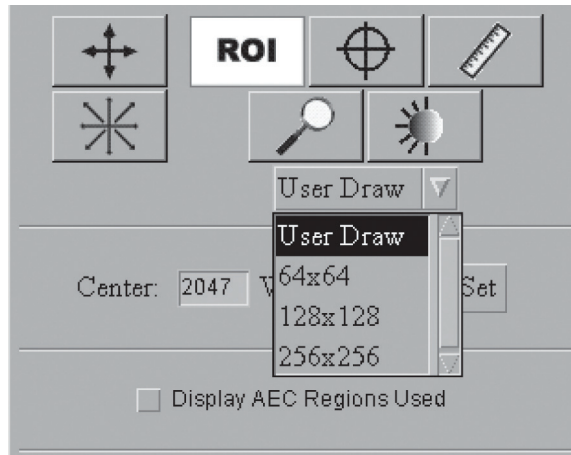

Figure 68: ROI Size Drop-down Menu

Method 1: Draw a custom box.	Method 2: Use a pre-defined box.
<ol style="list-style-type: none">1. Select the ROI button.2. From the drop-down menu, select User Draw.3. Click in the image and drag to draw the size you need.	<ol style="list-style-type: none">1. Select the ROI button.2. From the drop-down menu, select the size.3. Click the area of interest in the image.

Crosshairs

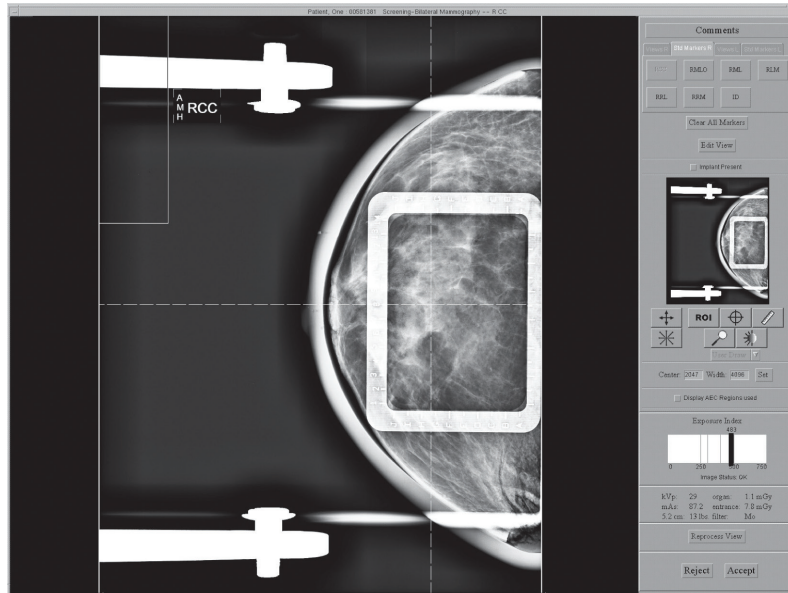



Figure 69: Preview with Crosshairs

1. Install a localization paddle.
2. Acquire the image.
3. If necessary, select the **Zoom/Pan** button and move through the image.
4. Select the **Crosshair** button .
5. Select the area of interest in the image.
6. Drag the crosshairs to the needed position, or select another area.
7. If necessary, use the **Zoom/Pan** functions to follow the crosshair lines to the grid from the localization paddle. The crosshair lines remain when the **Zoom/Pan** function is enabled and disabled.

Measurement

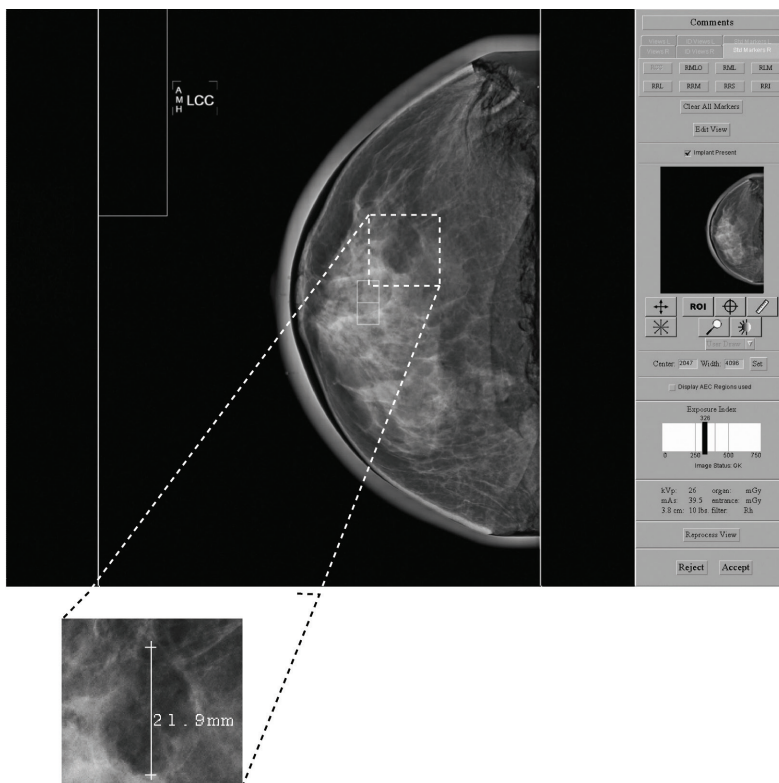



Figure 70: A Measurement on the Preview Screen

1. Select the **Measurement** button .
2. Click the first point then drag to the second point. The distance displays when you release the button.
3. Select the "+" at either end of the line to clear. There lines are not saved with the image.

Magnification



Use the Magnification function to view part of the image at 2X the displayed resolution.

1. Select the **Magnification** button.
2. Move the box that appears at the area of interest.
3. To turn off the magnification function, select the **Magnification** button a second time.



Note

You can use the magnification function on a Full Zoom image.

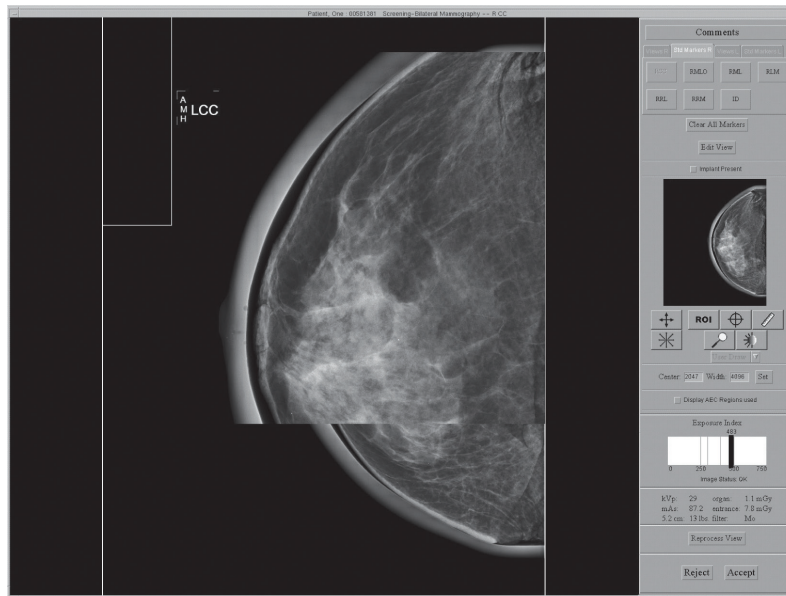



Figure 71: Preview with Magnification

Window/Level



1. Select the **Window/Level** button .
2. Select in the image and hold while you move the trackball.
 - Roll Up or Down to change the brightness (Level).
 - Roll Right or Left to change the contrast (Window).
3. To return to the original settings, double click the image.
4. Select the **Window/Level** button to turn off the feature.



Note

This operation does not change the final, processed Image.

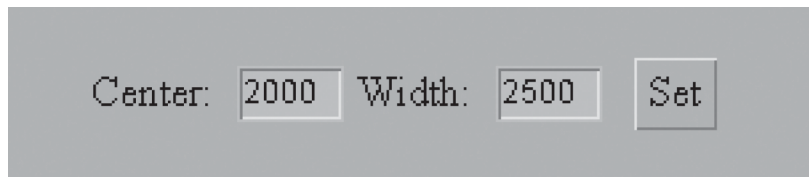

Figure 72: The Window/Level Settings

To enter a known **Window/Level** value:

1. Select the field (Center or Width) to change.
2. Enter a new number.
3. Select the **Set** button.

To return to the original setting, double click the image.

Display AEC Regions

To display the AEC area selected by the system, select the **Display AEC Regions** checkbox.

- Manual sensors show on the image as a white rectangle with rounded corners.
- The two Auto Sensor areas show on the image as 1cm by 1cm white squares.

To hide the AEC areas, deselect the **Display AEC Regions** checkbox.

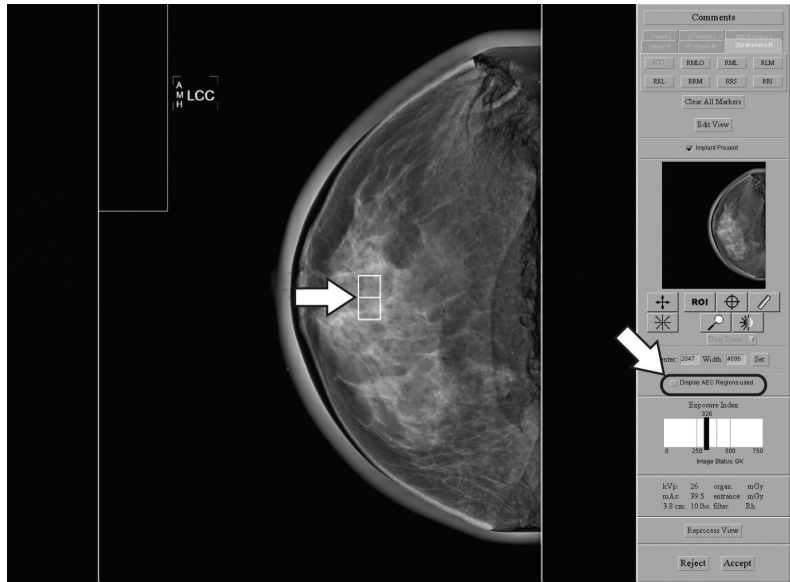

Figure 73: AEC Regions

Exposure Index

Use the Exposure Index as a general guide to compare the selected Exposure Techniques to the quality of the acquired image.

- "Image Status: OK" shows that the image processing was applied.
- "Image Status: Raw" shows that image processing was not applied.
- A number after the image status shows a problem with the image processing. Reject the image. Contact Service Support.

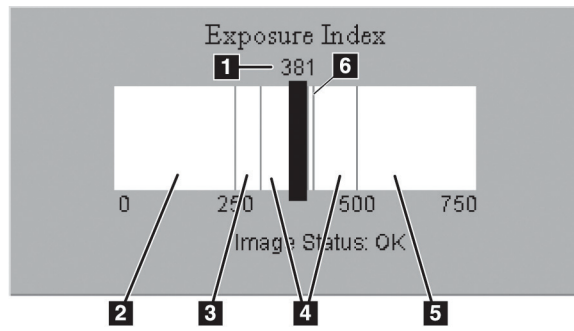

Figure 74: Exposure Information

Figure Legend

1. Exposure Index-pixel count
 2. Low exposure area—evaluate the image for excess noise. Re-acquire, if necessary.
 3. Satisfactory, but below ideal exposure area
 4. Ideal exposure area
 5. High exposure area—the image is more than sufficient. You can reduce the radiographic technique for the next exposures.
 6. The Exposure Index line related to imaging of the ACR phantom
- For Manual and TEC modes, the Exposure Index calculates an area approximately one centimeter from the chest wall on the centerline of the image.
 - For all AEC modes, the Exposure Index calculates for the AEC areas used.

Exposure and Dose/Entrance Surface Exposure Information

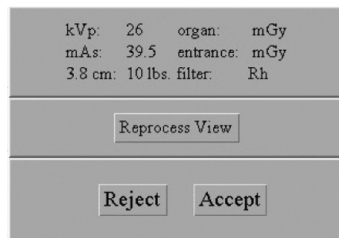

Figure 75: Exposure Information

The exposure information is displayed in the Tools area. An estimate of the average glandular organ dose and the entrance surface exposure are displayed.

6.4.4 Accept or Reject

Select Accept or Reject to close the Preview screen. The sequence continues by highlighting the next view.

Accept

To accept the image, select the **Accept** button.

- The full resolution image with all related attributes is marked as accepted in the pool.
- The system transmits the image to the selected output devices.

Reject

To reject the image:

1. Select the **Reject** button.



Note

Reject Analysis uses this information (required for Quality Control).

2. Select the reason for the reject.

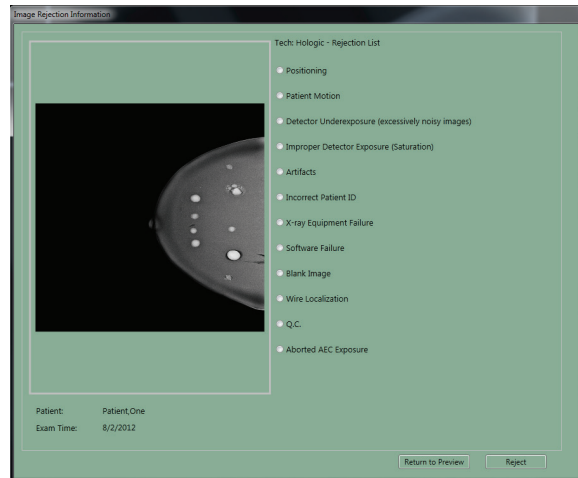

Figure 76: The Reject Reasons List

3. Select the Reject button. The system moves the image to the Reject Bin. An asterisk displays next to the View label of a rejected image.



Figure 77: A Rejected Image

6.4.5 Additional Information About Accepted/Rejected Images

After you reject an image, the Preview closes and you can:

- Re-acquire the rejected View.
- Select a different View.
- Close the Procedure.

The Image Repetition Information Dialog Box

When you accept a second image for the same View, the Image Repetition Information dialog box appears.

1. Select the reason for the repeat.
2. Close the dialog box.

How to Accept a Rejected Image

To accept a rejected image:

1. Reject the image that was taken as the replacement for the rejected image.
2. In the Patient View screen, select the **Review** button (below the Output box).
3. In the **Review** dialog box, select the tab for the View.
4. Select the **Rejected Image** thumbnail image to accept.
5. Select the **Comments** button to add or delete comments.
6. Select the **OK** button to close the **Comments** dialog box.
7. Select the **Set Accepted** button.

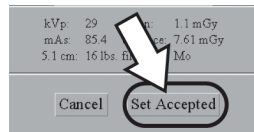

Figure 78: Set Accepted Button on Review Screen

8. Select the **OK** button to close the **Review** dialog box.

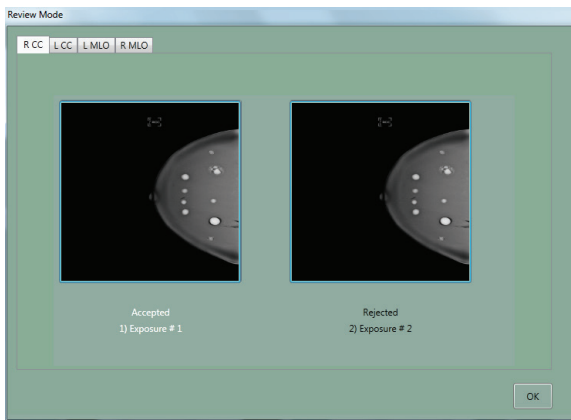

Figure 79: Accept Rejected Image

When you accept a rejected image, the Send Image to Output dialog box displays. Select **Yes** to send the images to the selected output group.



Note If you select the **No** button, you can resend the images with the Image/Spool Management function.

How to Reject an Accepted Image

To reject an Accepted Image:

1. In the **Patient View** screen, select the **Review** button.
2. In the dialog box, select the tab for the View to reject.
3. Select the Accepted Image.

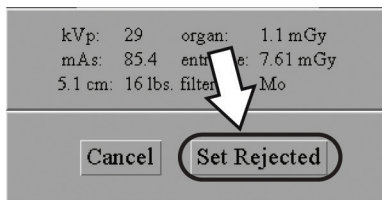

Figure 80: Set Rejected Button

4. Select the **Set Rejected** button.
5. Select a reason for the reject. See the [figure The Reject Reasons List](#) on page 96.
6. Select the **Reject** button.
7. Select the **OK** button. The displayed thumbnail image disappears from the Patient View screen.



Note After you reject an Image with this method, the image is **not** removed from the output queues. To delete the image from the queues, see the table in [Manage Queues](#) on page 71. The Rejected Image is added to the Reject Analysis Bin for tracking purposes.

6.5 A Screening Exam Sequence Suggestion

Table 14: Workflow Suggestions to Select a Patient and Acquire an Image

Action	What it looks like
<p>1. Start up the system and log in to Operating System and Application. See Procedure for Startup on page 31.</p>	 <p style="text-align: center;">Figure Legend</p> <ol style="list-style-type: none"> 1. Power On button 2. Power On indicator light
<p>2. Select the Procedure, when more than one is scheduled.</p> <p style="text-align: center;">Select from the scheduled procedures list</p> <ol style="list-style-type: none"> a. Find the procedure in the list. b. Click the Select button. <p style="text-align: center;">Add a procedure</p> <ol style="list-style-type: none"> a. Select New in the Procedure area. b. Select the procedure from the list. c. Select the Accept button. 	
<p>3. Edit the Patient Information, if necessary. To edit:</p> <ol style="list-style-type: none"> a. Select the patient from the patient list. b. Select Edit from the Patient area. c. Make the changes in the Edit Patient screen. d. Select the Accept button. 	
<p>4. Install the accessories. See The Selenia Accessories on page 41 for installation, removal, and alignment procedures for each device.</p>	<ul style="list-style-type: none"> • Face Shield • Compression Paddle • Magnification Platform • Crosshair

Table 14: Workflow Suggestions to Select a Patient and Acquire an Image



Action	What it looks like
<p>5. Select the view:</p> <ol style="list-style-type: none"> Click Add View in the Patient View screen. In the dialog box, select a view from the list of Standard Mammography Views. To add multiple views, press and hold the Control key and select the views. Select the OK button. 	
<p>6. Select the Exposure Techniques.</p>	
<p>7. Position the system and patient.</p> <ol style="list-style-type: none"> Adjust the vertical height of the Breast Platform. Set the C-arm angle. Put the arm and hand of the patient in a safe location. Compress the breast. 	

Table 14: Workflow Suggestions to Select a Patient and Acquire an Image

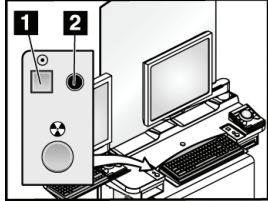
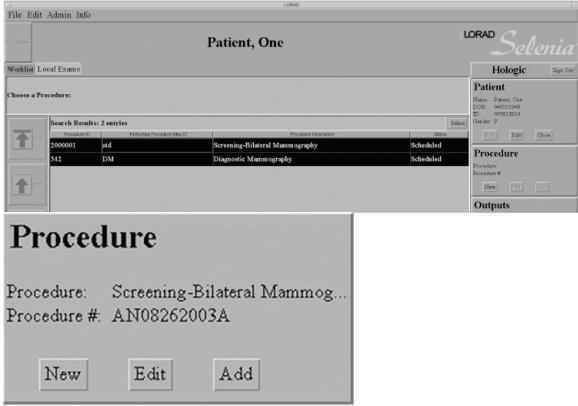
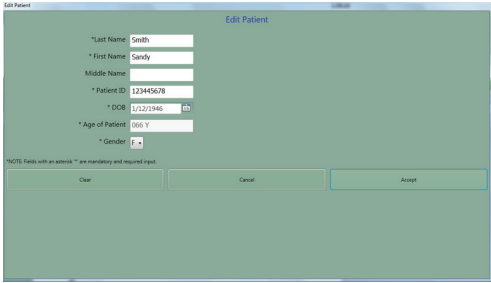
Action	What it looks like
<p>8. Acquire the image:</p> <ol style="list-style-type: none"> a. Make sure that the message area of the screen displays "Ready" (see item 1 in the following figure) and there is no "X" through the x-ray indicator (see item 2). b. Press and hold the x-ray buttons. c. Inspect the image on the Preview Screen, then select the Accept or Reject button. 	
<p>9. Close the procedure:</p> <ol style="list-style-type: none"> a. Select the Close Procedure button. b. Select the Yes button. 	

Chapter 7: Maintenance and Cleaning

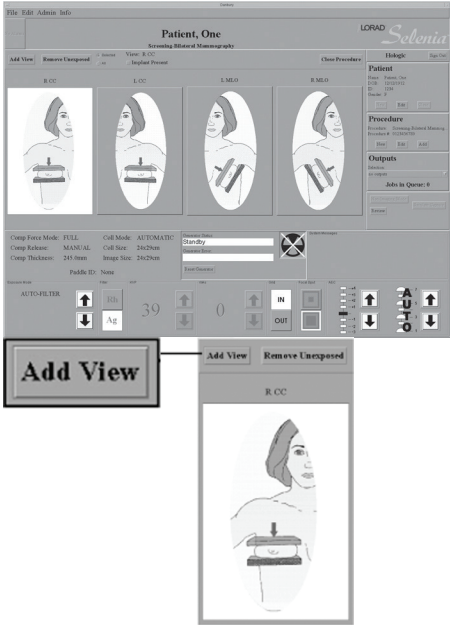
7.1 General Information About Cleaning

Before each examination, clean and use a disinfectant on any part of the system which touches a patient. Give the attention to the paddles and the image receptor.



Caution:

Do not use any hot source (like a heating pad) on the image receptor.

Be careful with the compression paddles. Inspect the paddles. Replace the paddle when you see damage.

7.1.1 For General Cleaning

Use a lint-free cloth or pad and apply a diluted dishwashing liquid.



Caution:

Use the least possible amount of cleaning fluids. The fluids must not flow or run.

If more than soap and water is required, Hologic recommends any one of the following:

- 10% chlorine bleach and water with one part commercially available chlorine bleach (normally 5.25% chlorine and 94.75% water) and nine parts water
- Commercially available isopropyl alcohol solution (70% isopropyl alcohol by volume, not diluted)
- 3% maximum concentration of hydrogen peroxide solution

After you apply any of the above solutions, use a pad and apply a diluted dishwashing liquid to clean any parts which touch the patient.



Warning:

If a paddle touches possible infectious materials, contact your Infection Control Representative to remove contamination from the paddle.



Caution:

To prevent damage to the electronic components, do not use disinfectant sprays on the system.

7.1.2 To Prevent Possible Injury or Equipment Damage

Do not use a corrosive solvent, abrasive detergent, or polish. Select a cleaning/disinfecting agent that does not damage the plastics, aluminum, or carbon fiber.

Do not use strong detergents, abrasive cleaners, high alcohol concentration, or methanol at any concentration.

Do not expose equipment parts to steam or high temperature sterilization.

Do not let liquids enter the internal parts of the equipment. Do not apply cleaning sprays or liquids to the equipment. Always use a clean cloth and apply the spray or liquid to the cloth. If liquid enters the system, disconnect the electrical supply and examine the system before returning it to use.



Caution:

Wrong cleaning methods can damage the equipment, decrease imaging performance, or increase the risk of electric shock.

Always follow instructions from the manufacturer of the product you use for cleaning. The instructions include the directions and precautions for the application and contact time, storage, wash requirements, protective clothing, shelf life, and disposal. Follow the instructions and use the product in the most safe and effective method.

7.2 Care and Cleaning—Acquisition Workstation and Value Console

7.2.1 How to Clean the Preview Display

Avoid touching the display screen.

Use care when cleaning the outer surface of the LCD screen. Always use a clean, soft, lint-free cloth to clean the display area. Microfiber cloths are recommended.

- Never use a spray or flow a liquid on the display.
- Never apply any pressure to the display area.
- Never use a detergent with fluorides, ammonia, alcohol, or abrasives.
- Never use any bleach.
- Never use any steel wool.
- Never use a sponge with abrasives.

There are many commercially available products to clean LCD displays. Any of the products free of the ingredients described above and used according to the directions of the manufacturer can be used.

7.2.2 How to Clean the Keyboard

Wipe the surfaces with a CRT wipe. If necessary, clean the keyboard with a vacuum. If liquids enter the keyboard, contact Technical Support for a replacement.

7.3 Preventive Maintenance

Table 15: User Preventive Maintenance

Maintenance Task Description	Recommended Frequency						
	Each Use	Daily	Weekly	Bi-weekly	Monthly	Quarterly	Semi-annually
Clean & disinfect paddle	x						
Clean & disinfect breast platform	x						
Visually inspect all paddles for damage	x						
Recommended/ required start of operation verifications		x			x		
All daily recommended/ required calibration		x					x
Diagnostic Review Workstation Quality Control *			x				
Detector Flat Field Calibration *			x				
Artifact Evaluation *			x				
Phantom Image *			x				
Signal to Noise / Contrast to Noise Measurements *			x				
Compression Thickness Indicator *				x			
DICOM Printer Quality Control			x				
View boxes and Viewing Conditions			x		x		
Repeat/Reject Analysis*						x	
Compression *							x
Visual Checklist *					x		
Emergency Stops					x		
Clean array dust filter					x		

* Refer to Quality Control Manual

Appendix A: System Specifications

A.1 Dimensional Information

A.1.1 Tubestand (Gantry with C-arm)

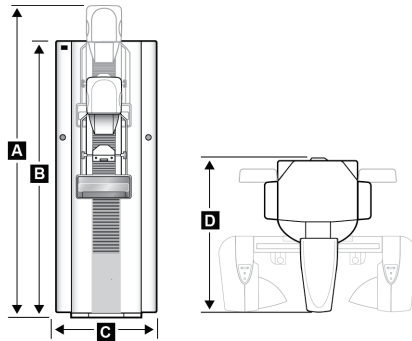

Figure 81: Tubestand Dimensions

A. Height with C-arm Travel	213.0 cm (84.07 inches) \pm 1.0 cm (0.4 inches) at highest C-arm travel
B. Height	190.0 cm (74.8 inches)
C. Width	65.0 cm (25.6 inches) \pm 1.0 cm (0.4 inches) (C-arm at 0° position)
D. Depth	110.0 cm (43.3 inches) \pm 1.0 cm (0.4 inches)
Weight	300 kg (661 lb.) \pm 20 kg with Image Receptor

A.1.2 Acquisition Workstation

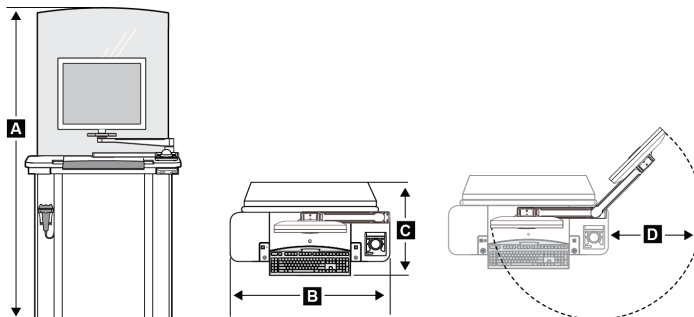

Figure 82: Acquisition Workstation Dimensions

A. Height	189.5 cm (74.6 inches) (maximum)
B. Width	107 cm (42.1 inches)
C. Depth	76 cm (30.0 inches)
D. Swivel Arm Radius	60.5 cm (23.81 inches)
Weight	120 kg (264.5 lb.) (maximum)

A.1.3 Selenia Value Console

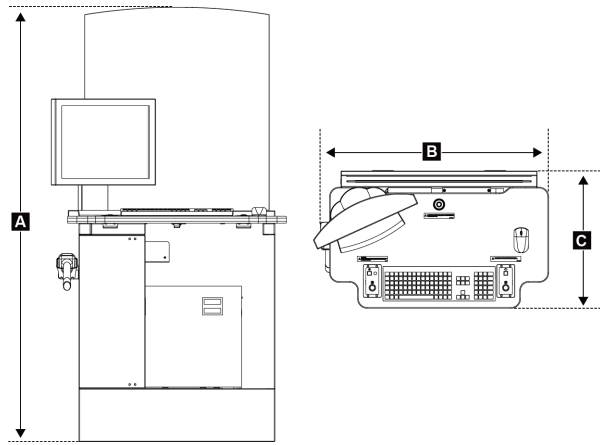

Figure 83: Value Console Dimensions

A	Height	191.3 cm (75.3 inches)
B	Width	101.2 cm (39.8 inches)
C	Depth	60.5 cm (23.8 inches)
	Weight	163.3 kg (360 lb.) (maximum)

A.2 Operating Environment

A.2.1 General Operating Conditions

Temperature Range	20 °C (68° F) to 30 °C (86° F)
Maximum rate of temperature change	<10 °C/hr
Relative Humidity Range	10% to 80% non-condensing
BTU output	Typical Range 1700–2500 BTU/hr

A.3 Storage Environment

A.3.1 Tubestand

Temperature Range	-25 °C (-13° F) to +60 °C (140° F)
Humidity	Zero to 95% humidity—non-condensing (not packaged for outdoor storage)

A.3.2 Image Receptor

Storage Temperature Range	10 °C (50° F) to 40 °C (104° F)
Maximum rate of temperature change	<15 °C/hr
Storage Humidity Range	10% to 80% humidity— non-condensing (not packaged for outdoor storage)

A.4 Electrical Input

A.4.1 Tubestand

<i>Mains Voltage</i>	<i>200/208/220/230/240 VAC nominal, true sinusoidal, (tap selectable at installation) ±10%, Single Phase, 50/60 Hz ± 5%, permanently wired</i>
<i>Mains Impedance</i>	<i>Maximum line impedance not to exceed 0.20 ohms for 220/230/240 VAC, 0.16 ohms for 200/208 VAC</i>
<i>Maximum Power Consumption</i>	<i>6.5 kVA for 5 second duration</i>
<i>Standby Current</i>	<i>4.0 A (maximum)</i>
<i>Maximum Line Current</i>	<i>35 A for 5 seconds [momentary rating per NEC 70 Article 517 (2014 Edition)]</i>
<i>Recommended Branch Circuit Breaker Rating</i>	<i>25 A minimum, refer to NEC 70 Article 517 (2014 Edition)</i>

A.4.2 Acquisition Workstation

<i>Input Line Voltage</i>	<i>100/120/200/208/220/230/240 VAC nominal, true sinusoidal, (tap selectable at installation), ± 10%</i>
<i>Input Current</i>	<i>8.0 A maximum @ 100/120 VAC 3.5 A maximum @ 200/208/220/230/240 VAC</i>
<i>Frequency</i>	<i>50/60 Hz ±5%</i>
<i>Number of Phases</i>	<i>Single</i>

A.5 Acquisition Workstation Technical Information

<i>Computer Memory</i>	<i>2 GB RAM minimum</i>
<i>Disk capacity</i>	<i>> 60 GB Image Storage</i>
<i>Storage Media</i>	<i>CD-RW Disks</i>
<i>Display Adapter Card</i>	<i>1600 x 1200 matrix minimum 8 bit gray scale display</i>
<i>Display</i>	<i>1600 x 1200 matrix minimum 450 cd/m2 nominal brightness</i>
<i>Network Interface</i>	<i>10/100 Base-T Ethernet</i>
<i>Remote Diagnostics</i>	<i>Internet</i>
<i>Graphical User Interface</i>	<i>X-ray exposure control Configurable mammographic Workflow Patient demographics Brightness and contrast control Magnification screen Pixel value readout QC test tools System Status Monitoring Error reporting Unattended archiving and printing</i>
<i>Radiation Shield Pb equivalence</i>	<i>Rated for a 0.5 mm Pb (lead) equivalence</i>

A.6 Tubestand Technical Information

A.6.1 C-arm

<i>Motorized C-arm Rotation Speed</i>	<i>Variable speed (18° per second maximum). Rotation speed is service selectable: 50% to 100% in 5% increments. Motor Control provides soft start and dynamic braking.</i>
<i>C-arm Rotation Range</i>	<i>+195° +2° /-0° to 0° ±0.5° to -150° +0° /-2° (detent at 0°, ±90°). Rotation angle is displayed on both sides of Gantry.</i>
<i>Vertical Travel</i>	<i>74.5 cm (29.5 inches) total travel.</i>
<i>Source-to-Image Distance (SID)</i>	<i>66.0 cm (26.0 inches) ± 1.0 cm (0.4 inches)</i>
<i>Source-to-Image Receptor Support Device Distance</i>	<i>64.0 cm (25.2 inches) ± 1.0 cm (0.4 inches)</i>
<i>Magnification Ratio</i>	<i>1.8 x for objects 22.5 mm above the magnification platform breast support surface</i>

A.6.2 Compression

<i>Manual Compression Force</i>	<i>Limited to a maximum of 300 N +0/-89 N (67.4 lb. +0/-20 lb.) from 0° to +/-90° C-arm rotation. Not less than 169 N (38 lb.) for a C-arm angle range greater than +150° and an angle less than -150°.</i>
<i>Motorized Compression</i>	<i>Functions in three operating modes, Pre-compression, Full-Range, Dual Compression, user selectable through software.</i>
<i>Pre-Compression Force</i>	<i>67 N +0/-22.3 N to 133.5 N ±22.3 N (15 lb. +0/-5 lb. to 30 lb. ±5 lb.)</i>
<i>Full-Range Compression Force</i>	<i>89 N ±22.3 N to 178 N ±22.3 N (20 lb. ± 5.0 lb. to 40.0 lb. ± 5.0 lb.)</i>
<i>Dual Mode Compression</i>	<i>Provides Pre-Compression force upon first activation of compression switch; then, if switch is activated within 2 seconds, the force is increased incrementally for each additional switch activation, up to the user selected FULL compression force.</i>
<i>Compression Controls</i>	<i>Up/Down controls on both sides of C-arm and on 2-position footswitch (Motorized). Handwheel on both sides of Compression Device (Manual).</i>
<i>Compression Release</i>	<i>Manual or Automatic. Motorized Release mode controlled by push-buttons on both sides of the C-arm. User selectable automatic release mode raises Compression Device upon exposure termination. All release functions are disabled if a Localization paddle is detected.</i>
<i>Automatic Compression Release</i>	<i>Moves the compression device upward a predetermined distance (10 cm). For Magnification Mode this may be less.</i>

<i>Compression Down Motion Variable Speed</i>	<i>Service Selectable between approximately 10% through 100% of full speed.</i>
<i>Compression Force Display</i>	<i>Two LED Displays on the Compression Device show the compression force through the range of 10 lb. to 67.4 lb. (44.5 N to 300 N) in 1 lb. (4.4 N) increments.</i>
<i>Compression Force Display Accuracy</i>	<i>±4.5 lb. (±20 N)</i>
<i>Compression Thickness Display</i>	<i>Two LED Displays on Compression Device measures between 0 and 15 cm above image receptor in 0.1 cm increments. The display is visible from both sides of the patient.</i>
<i>Compression Thickness Accuracy</i>	<i>±0.5 cm for thicknesses between 0.5 cm and 15 cm</i>
<i>Compression Paddles</i>	<i>Compression paddles are transparent. The paddles are composed of polycarbonate. The paddles provide a parallel plane to the image receptor and do not deflect by more than 1 cm difference from any surface providing compression under 25 lb. (111.1 N) of compression force (except for F.A.S.T. paddles.). The paddles are adjustable to provide the focal spot, compression device and image receptor alignment requirement.</i>

A.6.3 X-ray Tube: Molybdenum

<i>Focal Spot (NEMA / IEC)</i>	<i>Large (0.3 mm) Nominal Small (0.1 mm) Nominal</i>
<i>Tube Voltage</i>	<i>20 kV to 39 kV</i>
<i>Tube Current</i>	<i>Large Focal Spot = 100 mA between 25 and 32 kV Small Focal Spot = 30 mA between 25 and 32 kV</i>
<i>Anode Rotation</i>	<i>180 Hz (9600 RPM minimum)</i>
<i>Anode Angle</i>	<i>Bi-angular: Large focal spot at 16°, Small focal spot at 10°. X-ray tube angle at 6° to provide 22° (Large FS) and 16° (Small FS) anode to Image Receptor plane angle.</i>
<i>Anode Material</i>	<i>Molybdenum</i>
<i>X-ray Window</i>	<i>Beryllium 0.8 mm thickness (maximum)</i>

X-ray Tube Housing

<i>Over Temperature Protection Sensor</i>	<i>Internally connected in series with the stator common lead.</i>
<i>Maximum Temperature, Tube Housing Surface</i>	<i>55 °C (151° F)</i>
<i>Maximum Temperature, Tube Head Cover Surface</i>	<i>41 °C (105.8° F)</i>
<i>Safety Class</i>	<i>IEC 60601-1, Class I, IEC 60601-2-28</i>

X-ray Beam Filtration and Output

<i>Inherent Tube Filtration</i>	<i>0.0 mm Al equivalent</i>
<i>Added Filtration</i>	<i>Two-position filter changer mechanism to carry a 30-micron (0.03 mm) Molybdenum foil filter and a 30-micron (0.03 mm) Rhodium foil Filter. Type of filter is user selectable.</i>
<i>Beam Quality HVL for Mo/Mo Operation</i>	<i>At a given kilovolts, the measured HVL with the compression paddle in the x-ray beam is equal to or greater than the value of $kV/100+0.03$ (in units of mm of aluminum) but less than the value of $kV/100+0.12$ (in units of mm of aluminum).</i>
<i>Beam Quality HVL for Mo/Rh operation</i>	<i>At a given kilovolts, the measured HVL with the compression paddle in the x-ray beam is equal to or greater than the value of $kV/100+0.03$ mm Al (in units of mm of aluminum) but less than the value of $kV/100+0.19$ mm Al (in units of mm of aluminum).</i>
<i>Radiation Output</i>	<i>Equal to or greater than 800 mR/second for at least 3 seconds. Output is measured through the Compression Paddle, 4.5 cm above the breast support, 4.0 cm from the chest wall edge, using exposure techniques of Mo/Mo target/filter, large focal spot, 28 kV.</i>

A.6.4 X-ray Tube: Tungsten

<i>Tube Voltage</i>	<i>22 kV to 39 kV</i>
<i>Tube Current</i>	<i>Large Focal Spot = 100 mA between 25 and 32 kV Small Focal Spot = 30 mA between 25 and 32 kV</i>
<i>Anode Rotation</i>	<i>180 Hz (9500 RPM minimum)</i>
<i>Anode Angle</i>	<i>Bi-angular: Large focal spot at 16°, Small focal spot at 10°. X-ray tube angle at 6° to provide 22° (Large FS) and 16° (Small FS) anode to Image Receptor plane angle.</i>
<i>Anode Material</i>	<i>Tungsten</i>
<i>X-ray Window</i>	<i>Beryllium 0.8 mm thickness (maximum)</i>

X-ray Tube Housing

<i>Over Temperature Protection Sensor</i>	<i>Internally connected in series with the stator common lead.</i>
<i>Maximum Temperature, Tube Housing Surface</i>	<i>55 °C (151° F)</i>
<i>Maximum Temperature, Tube Head Cover Surface</i>	<i>41 °C (105.8° F)</i>
<i>Safety Class</i>	<i>IEC 60601-1, Class I, Type B, IEC 60601-2-28</i>

X-ray Beam Filtration and Output

<i>Inherent Tube Filtration</i>	<i>0.0 mm Al equivalent</i>
<i>Added Filtration</i>	<i>Two-position filter changer mechanism to carry a 60-micron (0.06 mm) Rhodium foil filter and a 60-micron (0.06 mm) Silver foil Filter. Type of filter is user selectable.</i>
<i>Beam Quality HVL for W/Rh Operation</i>	<i>At a given kilovolts, the measured HVL with the compression paddle in the x-ray beam is less than the value of $kV/100 + 0.03$ (in units of mm of aluminum).</i>
<i>Beam Quality HVL for W/Ag operation</i>	<i>At a given kilovolts, the measured HVL with the compression paddle in the x-ray beam is less than the value of $kV/100 + 0.03$ (in units of mm of aluminum).</i>
<i>Radiation Output</i>	<i>Equal to or greater than 230 mR/second for at least 3 seconds. Output is measured through the Compression Paddle, 4.5 cm above the breast support, 4.0 cm from the chest wall edge, using exposure techniques of W/Rh target/filter, large focal spot, 28 kV.</i>

A.6.5 X-ray Collimation

Available Collimated X-ray Fields:

Table 16: Collimation Settings

Predefined Collimation Settings
24 x 29 cm
18 x 24 cm
15 x 15 cm
10 x 10 cm
7.0 x 8.5 cm

A.6.6 Light Field Indication

<i>Light Field Lamp</i>	<i>Illuminates for 30 seconds, ± 5 seconds, upon pressing a Light Field switch on either side of the x-ray tubehead or by pressing a Compression Down switch. Extinguishes automatically upon exposure initiation. A shatter shield is provided.</i>
<i>Light Field Illuminance</i>	<i>160 lux (minimum)—meets 21 CFR 1020.31 requirements. Lamp is adjustable to provide alignment of the light field to the x-ray field.</i>
<i>Light Field-to-X-ray Field Congruency</i>	<i>Within 2% of SID</i>
<i>Ripple</i>	<i>2% or less (typical), maximum 4%</i>
<i>Topology</i>	<i>Pulse width modulated High Frequency, active servo controlled</i>

kV /mA Range

Table 17: LFS mA setting as a function of kV

Large Focal Spot	
kV	mA
20*	75 mA
21*	80 mA
22	85 mA
23	90 mA
24	95 mA
25-32	100 mA
33	85 mA
34-35	80 mA
36-37	75 mA
38-39	70 mA
<i>*Molybdenum Tubes only</i>	

Table 18: SFS mA setting as a function of kV

Small Focal Spot	
kV	mA
20	20 mA
21	22 mA
22	24 mA
23	26 mA
24	28 mA
25-32	30 mA
33-34	28 mA
35-37	26 mA
38-39	24 mA



Note

All values are for mAs values ≥ 40 mAs. For mAs values < 40 mAs, the mA value adjusts by the mA Factor listed in the following table as a function of mAs.

Table 19: mA Factor as a function of mAs

mAs	mA Factor
4-6	10%
8-10	20%
12-22	30%
24-38	60%
≥ 40	100%

Large Focal Spot Manual mAs Range:

TABLE 1 (default): 3 mAs through 400 mAs, 22 steps: 3, 4, 5, 6.4, 8, 10, 12.5, 16, 20, 25, 32, 40, 50, 64, 80, 100, 125, 160, 200, 250, 320, 400.



Note Lower limit is 4 mAs when grid is in field.

TABLE 2 (user selected): 3 mAs through 400 mAs, 55 steps: 3, 4, 5, 6, 7, 8, 9, 10, 12, 14, 16, 18, 20, 22, 24, 26, 28, 30, 32.5, 35, 37.5, 40, 42.5, 45, 47.5, 50, 55, 60, 65, 70, 75, 80, 85, 90, 95, 100, 110, 120, 130, 140, 150, 160, 170, 180, 190, 200, 220, 240, 260, 280, 300, 325, 350, 375, 400.



Note Lower limit is 4 mAs when grid is in field.



Note In AEC modes, in Large Focal spot, the mA setting adjusts downward, if necessary, to achieve the calculated mAs. mA can be adjusted as low as 10 mA.

Small Focal Spot Mag Manual mAs Range:

TABLE 1: 3 mAs through 100 mAs, 16 steps: 3, 4, 5, 6.4, 8, 10, 12.5, 16, 20, 25, 32, 40, 50, 64, 80, 100

TABLE 2: 3 mAs through 120 mAs, 38 steps: 3, 4, 5, 6, 7, 8, 9, 10, 12, 14, 16, 18, 20, 22, 24, 26, 28, 30, 32.5, 35, 37.5, 40, 42.5, 45, 47.5, 50, 55, 60, 65, 70, 75, 80, 85, 90, 95, 100, 110, 120

Accuracy, Reproducibility, and Linearity

Reproducibility < 0.05 coefficient of variation for 10 consecutive exposures (21 CFR).

Linearity < 0.10 for adjacent mAs selections per the following:
(X1-X2) is less than or equal to 0.10 (X1+X2) where X1 and X2 are average mR/mAs values for consecutive exposures (21 CFR).

mAs Accuracy ±5% or ±2 mAs, whichever is greater, from indicated, measured from the ground side of the tube circuit.

kV Accuracy Within 1 kV of the indicated kV

A.7 Imaging System Technical Information

A.7.1 Image Receptor

<i>Fluid ingress</i>	<i>No fluid from incidental spillage on the top surface of the Image Receptor seeps inside</i>
<i>Deflection</i>	<i>Does not exceed 1.0 mm at maximum compression</i>
<i>Active Imaging Area</i>	<i>24 cm x 29 cm Nominal. The active image area is marked on the digital image receptor/breast platform cover.</i>
<i>Image Size, Screening and Diagnostic Exams</i>	<i>18 x 24 cm nominal; locations: center, left, right 24 x 29 cm nominal; center location only</i>
<i>Image Size, Diagnostic-Spot Compression</i>	<i>18 x 24 cm nominal; locations: center, left, right</i>
<i>Image Size, Diagnostic-Magnification</i>	<i>18 x 24 cm nominal; center location only</i>
<i>Image Pixel Size</i>	<i>70 μm</i>
<i>Digital Image Receptor MTF -Nyquist frequency</i>	<i>> 0.40</i>
<i>DQE at 0 c/mm</i>	<i>50% or greater at 7.0 mR -0.0/+0.7 mR x-ray exposure</i>
<i>DQE at Nyquist frequency</i>	<i>15% or greater at 7 mR -0.0/+0.7 mR x-ray exposure</i>
<i>Saturation</i>	<i>X-ray exposure level at which image pixels are saturated is not less than 1000 mR</i>
<i>Dynamic Range</i>	<i>Linear response over at least 400:1 in x-ray exposure</i>
<i>Output Image</i>	<i>14 bit image data</i>
<i>Scatter Rejection</i>	<i>Lorad HTC™ high transmission cellular grid</i>
<i>Chest Wall Access</i>	<i>The distance from the outside edge of the Image Receptor enclosure to the Active Image Area along the chest wall is less than 5 mm.</i>
<i>Lateral Wall Access</i>	<i>The distance from the outside edge of the detector enclosure to the active detector area along the edges perpendicular to the chest wall is less than 40 mm.</i>
<i>ACR Phantom Score at MGD = 2mGy</i>	<i>At least 5 fibers, 4 specks, 4 mass</i>
<i>Image Preview Time</i>	<i>The time between completion of an x-ray exposure and availability of the Preview image: less than 20 seconds.</i>
<i>Transmission Limit</i>	<i>Within Federal Regulatory limit for screen-film mammography systems (21CFR 1020): 0.1 mR/h.</i>

A.8 Tissue Exposure Control (TEC) Mode

The Breast Density Default Setting

Selectable via the Generator default screen on the Acquisition Workstation. Breast density defaults to the default setting at the beginning of each new study and when the exposure mode is first changed to TEC.

Breast Density Panel

Update rate once every 2 seconds maximum

Mammography Unit Status Polling

Between image capture cycles, Acquisition Workstation requests and displays current technique at a rate not slower than once every 2 seconds. In TEC mode, the rate increases to no slower than once per second, but not faster than once per 0.75 seconds. System response time for a single Generator Technique command is 1 second or less.

A.9 Automatic Exposure Control (AEC)

<i>AEC Sensor</i>	<p>Positionable in seven locations, centered laterally in the image receptor support device. Position #1 is located 1 cm from the chest wall. Positions are spaced in 1.7 cm increments.</p> <p>The AEC region can be selected automatically by processing the pre-exposure image data to find the corresponding dense portion of the breast.</p> <p>When the AEC region auto-selection is enabled, the detector area that is scanned is dependent on the default x-ray collimation that is linked to the compression paddle ID. Change of collimation by the operator is ignored for AEC region auto-selection.</p> <p>LEDs for each AEC sensor position on the compression gantry indicate the selected position. The selected AEC region can be viewed after selecting the check box.</p> <p>The size and available position of the manual AEC regions are indicated at the x-ray input surface of the compression paddle.</p>
<i>AEC Auto-Filter Mode</i>	<p>The filter and kV are selected using the recommended table based exposure technique based on compressed breast thickness.</p> <p>The exposure is terminated at an mAs value as determined by the AEC system to yield a pixel count to which the unit has been calibrated.</p>
<i>AEC Auto-kV Mode</i>	<p>The Filter is not selectable. The filter defaults to Mo if the system is configured with Moly Tube. The filter defaults to Rh if the system is configured with a Tungsten Tube. Starting kV is determined by the Gantry. mAs is determined by the Digital Detector.</p>
<i>AEC Auto-Time Mode</i>	<p>The kV and filter are both user selectable.</p> <p>The exposure is terminated at a mAs value as determined by the AEC system to yield a pixel count to which the unit has been calibrated.</p>
<i>Exposure Termination</i>	<p>An exposure is aborted or prevented if:</p> <p>The predicted exposure time exceeds the x-ray tube limits. The predicted exposure time exceeds the safety backup timer setting.</p> <p>The predicted exposure time is less than 400 msec when the grid is in the x-ray field or less than 30 msec when the grid is out of the x-ray field.</p> <p>The user releases the exposure button prematurely.</p> <p>There is an error within the Selenia FFDM system.</p>
<i>AEC Reproducibility</i>	<p>AEC exposure reproducibility meets MQSA requirements as follows:</p> <p>For a 4 cm thick average breast phantom, coefficients of variation in mAs and digital values shall be less than 0.05 for four consecutive exposures of this phantom under each of the three AEC modes.</p>
<i>Exposure Adjustment</i>	<p>There is a "user-adjustable" scale factor that can be used to increase/decrease the final x-ray exposure (mAs) by 15% for each step from the default setting. A total of eight settings are available on the Acquisition Workstation, which allows the user to change the exposure from -55% of the default value to 160% of the default value.</p>



Note

AEC exposure adjustment is not available in all geographic regions.

A.10 Hardcopy Film Printing Devices

This section lists the relevant technical characteristics for the hardcopy film printing device.

A.10.1 Image Engine

<i>Film sizes</i>	<i>20 cm x 25 cm (8 inches x 10 inches)</i> <i>25 cm x 30 cm (10 inches x 12 inches), optional</i>
<i>Pixel size</i>	$\leq 70 \mu\text{m}$
<i>Grey level resolution</i>	≥ 8 bits
<i>Maximum Film Optical Density</i>	≥ 3.5

A.10.2 Interface

<i>Connectivity</i>	<i>DICOM 3.0 compatible</i>
<i>Data port</i>	<i>Ethernet</i>
<i>Transfer rate</i>	<i>Minimum: 10 Mbits/sec</i>
<i>Look up Tables (LUT)</i>	<i>Field programmable; Linear</i>

A.10.3 Printed Film

<i>Print to fit</i>	<i>If a 24 x 29 cm image is printed on a 20 x 25 cm (8 x 10 inches) film, the printer prints the image to fit onto a 20 x 25 cm (8 x 10 inches) film without cropping the image or without dropping rows and columns of data</i>
<i>Patient Information</i>	<i>Film meets ACR/MQSA requirements for patient demographics. Printed Information Is User Configurable.</i>

Appendix B: The Mobile Selenia

This appendix provides information about Selenia systems installed in a mobile environment.

B.1 General Information

B.1.1 The Vertical Position Override Switch (VPOS)

The Mobile Selenia has a Vertical Position Override Switch (VPOS) on the back of the Gantry. This switch can start the Selenia if the C-arm is lower than its normal operating position after rough-road travel.

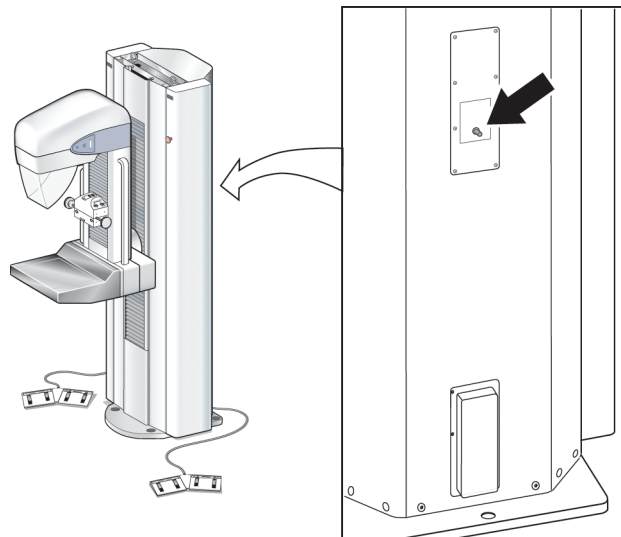

Figure 84: Location of Vertical Position Override Switch (VPOS)

Background

Switches located in the Gantry limit the C-arm vertical travel to a pre-defined range. When the C-arm reaches its highest or lowest point of normal travel, the switches engage to stop further motion. If the C-arm should travel past the Limit switches (in the event of switch failure or other electrical malfunction), a second switch engages that removes power from the system. A Field Engineer would normally be contacted to repair and restart the Selenia.

In a mobile environment (during transport), it is possible for the C-arm to 'creep' downward and beyond the two Limit switches. If this occurs, the Selenia would be disabled—the lower limit switch would engage, preventing the system from normal start-up. This is not a failure condition that would require a Field Engineer's attention. The Vertical Position Override Switch is used to allow the operator to start the system and raise the C-arm to within its normal working limits.

When to Use the VPOS

This condition shows on the first startup after transport. The Acquisition Workstation starts normally, but the Gantry does not startup. After Logon, an alert message appears that communication to the Generator is lost.

How to Use the Vertical Position Override Switch to Restart the Gantry

1. Press and hold the Vertical Position Override Switch—the Gantry starts. Continue to hold the switch pressed.
2. After approximately 5 seconds, lift the C-arm approximately 7.5 cm (3 inches) with the normal system controls. Release the VPOS after you lift the C-arm.
3. At the Acquisition Workstation, accept the prompt to restart the Generator. The Gantry turns off for a few seconds, then automatically restarts.
4. The system is ready for normal use.

B.2 Safety Conditions and Other Precautions



Warning:

The radiation shield is not approved for mobile use and is not provided. The coach manufacturer must provide adequate shielding.



Caution:

When shore power is unavailable, mobile power sources that provide equivalent performance may be employed. (see Mobile Specifications.) Proper system function and performance can only be ensured if continuous true sinusoidal VAC power is supplied per the system power input specifications and loading characteristics. Intermittently, the power source must provide 65 Amps at 208 VAC for minimum of 5 seconds, and 4 Amps maximum continuous otherwise. This load must be supported once every 30 seconds. In the event of shore or mobile power service interruption, the UPS must be capable of providing the operational power described above for a minimum of 4 minutes. Acquisition Workstation and Gantry power must be fed on separate dedicated circuits. The use of an uninterruptible power supply with active line conditioner is recommended on each power circuit. Accordingly, all ancillary mobile coach power should be distributed by other circuits. The electrical installation must be verified to meet system power input specifications and IEC 60601-1 safety requirements after initial installation and upon each relocation of the mobile coach.



Caution:

The temperature and humidity inside the vehicle must be maintained at all times. Do not allow environmental conditions to exceed stated specifications when the unit is not in use.



Caution:

For permanent archive, the Selenia must be attached to a PACS system or connected to a suitable hard-copy printer when in use.

B.3 Mobile Specifications

B.3.1 Shock and Vibration Limits

Vibration Limit

Not greater than 0.35 G (2 Hz to 200 Hz), as measured at mounting point of system to coach.

Shock Limit

Not greater than 1.0 G (½ sine pulse), as measured at mounting point of system to coach. An "air ride" coach suspension is recommended.

B.3.2 Coach Environment

Operating Environment

Temperature Range

20 °C (68° F) to 30 °C (86° F)

Maximum Rate of Temperature Change

<10 °C/hr

Relative Humidity Range

10% to 80% non-condensing

BTU output

Typical Range 1700–2500 BTU/hr

Non-operating/Transit Environment

Temperature Range

15 °C (59° F) through 35 °C (95° F)

Maximum Rate of Temperature Change

<15 °C/hr

Relative Humidity Range

10% to 80% non-condensing

B.3.3 Electrical Input

Tubestand

<i>Mains Voltage</i>	<i>200/208/220/230/240 VAC nominal, true sinusoidal, (tap selectable at installation) ±10%, Single Phase, 50/60 Hz ± 5%, permanently wired</i>
<i>Mains Impedance</i>	<i>Maximum line impedance not to exceed 0.20 ohms for 220/230/240 VAC, 0.16 ohms for 200/208 VAC</i>
<i>Maximum Power Consumption</i>	<i>6.5 kVA for 5 second duration</i>
<i>Standby Current</i>	<i>4.0 A (maximum)</i>
<i>Maximum Line Current</i>	<i>35 A for 5 seconds [momentary rating per NEC 70 Article 517 (2014 Edition)]</i>
<i>Recommended Branch Circuit Breaker Rating</i>	<i>25 A minimum, refer to NEC 70 Article 517 (2014 Edition)</i>

Acquisition Workstation

<i>Input Line Voltage</i>	<i>100/120/200/208/220/230/240 VAC nominal, true sinusoidal, (tap selectable at installation), ± 10%</i>
<i>Input Current</i>	<i>8.0 A maximum @ 100/120 VAC 3.5 A maximum @ 200/208/220/230/240 VAC</i>
<i>Frequency</i>	<i>50/60 Hz ±5%</i>
<i>Number of Phases</i>	<i>Single</i>

B.4 How to Prepare the System for Transport

Perform these steps before you transport the Mobile System:

1. Rotate the C-arm to 0 degrees (CC position).
2. Lower the C-arm to its lowest position.
3. Remove all power from the system.
4. Remove all system accessories (like the Face Shield, and Compression Paddles) before transport. Store all accessories correctly to make sure the components are not damaged.

B.5 How to Test the System Integrity After Transport

Instructions: Photocopy this checklist for use after the system is relocated.

Name _____ Date _____

System Serial Number _____

Table 20: Integrity Checklist

Evaluated	Control Functions	Reference
Mechanical System Tests		
	Compression Up/Down	Controls and Functional Tests on page 33
	Compression Release	Controls and Functional Tests on page 33
	C-arm Rotation	Controls and Functional Tests on page 33
	C-arm Up/down	Controls and Functional Tests on page 33
	Collimator Override	Controls and Functional Tests on page 33
	Light Field Lamp	Controls and Functional Tests on page 33
	Smart Paddle System	Controls and Functional Tests on page 33
	Emergency Off Switches	Emergency Off Switches on page 23
Quality Control Tests		
	Artifact Evaluation	Selenia QC Manual
	SNR/CNR Measurement	Selenia QC Manual
	Phantom Image Evaluation	Selenia QC Manual
	Compression Thickness	Selenia QC Manual

Index

A

- accept
 - rejected image • 97
- Accept button • 96, 99
- accessories
 - compression paddles • 42
 - Smart Paddles • 33, 43
 - magnification platform • 47
- acquire images • 82, 99
- Acquisition Workstation
 - circuit breaker location and function • 22
- add
 - additional view to procedure • 81, 99
 - new entry with function key • 26
 - new patient • 54
 - user • 67
- AEC
 - region, display on preview screen • 94
 - select Exposure Mode with keyboard • 26
 - sensor position • 26, 29, 30
- alarms • 79
- annotation tools list • 85
- archive, commit to storage function enabled • 70
- AUTO AEC sensor
 - display region used • 94
- average glandular organ dose display • 95
- avoid injury or equipment damage • 104

B

- bar code scanner • 9, 26
- breast density • 26
- button
 - compression release • 25
 - Eject, on CD-RW drive • 73
 - on and x-ray • 25
- button (software)
 - Accept • 54, 56
 - Add View • 81, 99
 - Brightness/Contrast (Window/Level) • 93
 - Cancel/Clear • 54, 56
 - Clean Up • 76
 - Clear All Markers • 87

- Comments • 86
- Crosshairs • 90
- Edit View • 87
- Full Zoom/Pan • 88
- Implant Present • 88
- Import Priors • 75
- Magnification button • 92
- Measurement • 91
- New Patient • 54
- Query Retrieve Priors • 75
- Quick Zoom/Pan • 88
- Reject • 97
- Remove Unexposed Views • 81
- Resend • 74
- Resend Stopped Job • 71
- Retrieve and Import • 75
- Review • 97
- ROI (Region of Interest) • 89
- Set Accepted • 97
- Set Rejected • 98
- Window/Level (Brightness/Contrast) • 93

C

- calibration messages • 76
- care and cleaning • 104
- C-arm
 - controls and displays • 28, 29
 - Gantry rotation switches • 28
 - rotation switches • 29, 33
 - up and down • 33
- CD, CD-RW
 - available space on • 77
 - ejecting disks • 72
 - importing images from • 73
- CD-RW Drive
 - Eject button • 73
- circuit breaker • 9
 - Gantry • 22, 28
- Clean Up button • 76
- Clear All Markers button • 87
- close
 - Exam (Procedure) key • 26
 - procedure • 81, 99

- collimator
 - automatically set to paddle size • 65
 - override • 33
- Comments
 - button • 97
 - entering or modifying • 86
- commit function, archive • 70
- complaints, product • 2
- compliance • 14, 15
 - label locations • 17
- compression
 - automatic release • 110
 - controls and displays • 30
 - down/up • 33
 - force display accuracy • 110
 - functional tests • 33
 - release buttons • 25
 - thickness
 - display • 30
 - display accuracy • 110
- compression paddles
 - cleaning • 42
 - FAST paddles • 43
 - installing and removing • 42
- contrast, change for printer • 75
- controls • 22, 30
 - AEC sensor position • 30
 - automatic compression release • 33, 110
 - C-arm • 29, 30, 33
 - C-arm rotation • 29, 33
 - collimator override • 29, 33
 - compression • 29, 30, 33
 - compression release buttons • 25
 - handwheels • 30
 - light field lamp • 29, 33
 - location and appearance • 33
 - manual compression • 29
- Crosshair device • 90
 - aligning to localization paddle • 49
 - installing and removing • 48
- D**
- defaults
 - system • 65
 - system view order • 66
- delete job from queue • 71
- delete user • 67
- determine job status • 71
- digital markers • 84
- dimensions • 107
- disk
 - ejecting CD from drive • 72
 - space available • 77
- Dismiss button • 31
- display • 24
 - AEC region used • 94
- Dorsal/Ventral hanging • 84
- dose/entrance surface exposure information • 95
- E**
- edit
 - edit user • 67
 - patient data • 55
- edit user • 67
 - add or edit • 67
 - delete • 67
- Edit View button • 87
- Eject CD • 72
- electrical input • 109
- Emergency Off switches • 28
 - restart dialog box • 38
- enhancement tools list • 85
- enter new patient data • 54
- entrance surface exposure display • 95
- environment • 108
- exam room door indicators • 13
- exposure
 - duration • 13
 - information • 95
 - ready indicators • 82
- exposure index • 95
- exposure techniques
 - select the mode • 26
 - select with function keys • 26
 - used • 74
- F**
- FAST paddles • 43
- files, select and unselect for import • 73
- film label area, location • 84

film printer • 22
filter, select with function key • 26
focal spot, select • 26
footswitches • 9
Full Zoom/Pan • 88
function keys • 25, 26

G

Gantry
 circuit breaker location and function • 22
 controls and displays • 28
 Emergency Off switches • 28
 restart mobile with VPOS • 122
 rotation switches for C-arm • 28
Gantry ID • 78
Generator Status • 82
grid in/out position toggle key • 26

H

hanging options • 84

I

image display area • 83
image enhancement and annotation tools • 85
Image Management
 Repreview • 75
 Resend • 74
 using • 70, 74, 75
image processing display • 95
image receptor
 aligning localization paddle with • 49
 no heat on • 9
 rotation switch • 29
 storage temperature • 108
 technical information • 116
Image Repetition • 97
image status • 95
images
 comments • 86
 film labeling area • 84
 identifying • 54
 import files from CD • 73
 outputs • 58
 Preview screen • 83
 processed • 95

rejected • 97
remaining space for • 77
repreviewing • 75
resending • 74
Review dialog box thumbnails • 97
rules for automatic reclamation • 77
sizes • 116
tools • 85
viewing full resolution • 92

Implant Present • 81
 button • 88
import
 image files • 73
 priors in background • 75
indicator, exam door • 13
Info menu • 77
initials, where used • 67
initiating x-ray exposure • 25
integrity checklist, mobile • 125
intended uses • 1
interlocks • 14
international symbols • 7

J

job status, determine • 71
jobs in queue • 58, 80

K

keyboard • 25
 function keys, set exposure techniques • 26
keypads • 25
kV, select • 26
kV/mA range • 114

L

label locations • 17
laser printer • 9
Launch dialog box • 31
light field lamp • 33
localization paddle • 46
 aligning crosshair device with • 49

M

Magnification

- crosshair device • 49
- paddles • 46
- platform • 47

Magnification button • 92

Manage Queues • 71

- delete (cancel) job status • 71
- determine job status • 71

manual collimation, effects • 65

Markers

- digital • 84

mAs

- focal spots manual range • 114
- select • 26

Measurement button • 91

Menu bar • 64

mobile information • 121, 125

mobile system

- C-arm position switch • 121
- integrity checklist • 125
- safety considerations • 122
- specifications • 123
- temperature/humidity control requirements • 122
- tests, pre/post transport • 124
- Vertical Position Override Switch (VPOS) • 121, 122

modality worklist provider, query • 53

monthly system tests • 38

mouse • 25

N

New

- Patient • 54

New Entry function key • 26

O

on and x-ray buttons • 25

operating conditions • 108

operating conditions, mobile systems • 123

Operating System (OS) • 31

outputs

- add new output group • 68

change/select destinations • 58

edit output group • 68

send accepted/rejected images to • 97

P

paddles

- identification • 45
- realigning front edge with image receptor • 44

Panel Power dialog box • 38

Patient

- add new • 54
- edit data • 55
- Face Shield • 13
- protecting from reclamation • 70
- unprotect • 70

Patient Name, tab for local database • 53

pixel count • 95

positioning, optimized for small breast with Smart Paddle • 43

post start-up tests • 33

power failure • 9, 39

Power On

- button • 25, 31
- indicator light • 25

PPS status • 75

- menu item • 64

preventive maintenance • 9, 105

Preview Image

- screen • 83
- tools • 83

printer • 75

- copies of images • 74
- print data on film • 22

procedure

- close with function key • 26

Progressive Preview • 83

Protect Patients • 70, 77

Q

Quality Control

- controls and functions tests • 33

query

- Modality Worklist • 53, 99
- retrieve priors • 75
- retrieve priors, results • 75

Query button • 99

queues

managing • 71

Quick Zoom/Pan • 88

R

radiation symbol, X-ray indicator • 25

raw image status • 95

Ready • 82

Region of Interest (ROI), button • 89

region used to calculate exposure index • 95

reject

Accepted image • 98

image • 96, 97

Reject button • 96, 98, 99

Remove Unexposed Views • 81

Repreview, using • 75

reprint images • 74

Resend Stopped Job • 71

restart

Gantry with mobile VPOS • 122

system after Emergency • 38

restart system in Sleep mode • 38

retract/engage grid • 26

Retrieve Priors • 75

Review button • 97

Review dialog box

thumbnails, accepted images • 97

view tab • 97, 98

review reject Accepted image • 98

Rotation Angle displays • 28

rotation switches

C-arm and Gantry • 33

Gantry • 28

S

safety

isolation integrity • 9

mechanical • 13

mobile requirements • 122

radiation • 13

screens

Preview Image • 83

Review dialog box • 97

View Order Editor • 66

search

hints for use • 54

Local Exams • 99

retrieve priors • 75

select

AEC position with keyboard • 26

breast density in TEC mode • 26

exposure techniques • 26

grid position • 26

outputs • 58

Select a Patient screen • 52

send

accepted rejected images to outputs • 97

images to an output-post procedure • 74

Set Rejected button • 98

Set Technique Defaults screens • 65

shield

patient face • 13

radiation • 13

Smart Paddle, functions • 33

Smart paddles • 43

SMPTE pattern • 76

software version • 77

specifications, mobile • 123

Standard Setup screens • 65

status, image • 95

stopped job in queue, resend • 71

switch users • 40

switches

AWS and Value Console circuit breakers • 22

Gantry circuit breaker • 28

Vertical Position Override • 122

symbols, international, defined • 7

system

controls and functional tests • 33

restart in sleep mode • 38

tests after transport • 125

system messages • 79

system tests • 38

T

TEC

select Exposure Mode with keyboard • 26

technical information

exposure modes • 117

printers • 119

- technologist, default view order • 80
- temperature (IR) • 77
- test patterns • 76
- tests
 - after transport • 125
 - monthly system • 38
- thumbnails • 97
- tools, list of image enhancement and annotation • 85
- trackball • 25
- turning on system in Sleep mode • 38

U

- unprotect patients • 70
- UPS
 - shut down Acquisition Workstation • 39
- user setup function • 67
- users, OS/Application names & passwords • 31

V

- Value Console
 - circuit breaker location and function • 22
- Vertical Position Override switch • 121, 122
- view
 - default order • 80
 - prior images on AWS • 75
 - rejected image • 97
 - selecting • 80
- View Order Editor screen • 66

W

- warnings, cautions and notes • 8, 14
 - accessories • 9
- Window/Level • 93
- worklist • 53, 54, 55
 - tab • 53

X

- x-ray
 - collimated fields • 33, 113
 - indicators • 25
- x-ray symbol • 82
- x-ray tube
 - Molybdenum • 111
 - Tungsten • 112

Hologic is defining the standard of care in women's health.

Our technologies help doctors see better, know sooner, reach further and touch more lives. At Hologic, we turn passion into action, and action into change.

BREAST IMAGING SOLUTIONS • INTERVENTIONAL BREAST SOLUTIONS • BONE HEALTH
PRENATAL HEALTH • GYNECOLOGIC HEALTH • MOLECULAR DIAGNOSTICS

HOLOGIC®

www.hologic.com | info@hologic.com | +1.781.999.7300

North America / Latin America

35 Crosby Drive
Bedford, MA 01730-1401
USA



Europe

Everest (Cross Point)
Leuvensesteenweg 250A
1800 Vilvoorde
Belgium

Asia Pacific

7th Floor, Biotech Centre 2
No. 11 Science Park West Avenue
Hong Kong Science Park
Shatin, New Territories
Hong Kong

Australia / New Zealand

Suite 402, Level 4
2 Lyon Park Road
Macquarie Park NSW 2113
Australia