

Affirm™

Prone Biopsy System



User Guide

MAN-04480 Revision 002

HOLOGIC®

Affirm™

Prone Biopsy System

User Guide

For Software Version 1.0

Part Number MAN-04480

Revision 002

April 2016

Technical Support

USA: +1.877.371.4372

Europe: +32 2 711 4690

Asia: +852 37487700

Australia +1 800 264 073

All Other: +1 781 999 7750

HOLOGIC®

© 2016 Hologic, Inc. Printed in the USA. This manual was originally written in English.

Hologic, Affirm, ATEC, Eviva, Windows and associated logos are trademarks and/or registered trademarks of Hologic, Inc., and/or its subsidiaries in the United States and/or other countries. All other trademarks, registered trademarks, and product names are the property of their respective owners. This product may be protected by one or more U.S. or foreign patents as identified at www.Hologic.com/patents.

Table of Contents

List of Figures _____ **xi**

List of Tables _____ **xiii**

1: Introduction _____ **1**

1.1 Preface 1

1.2 Intended Use..... 1

 1.2.1 Indications for Use..... 1

 1.2.2 Contraindications..... 1

1.3 Essential Performance 1

1.4 System Capabilities..... 2

1.5 User Profiles..... 2

 1.5.1 Mammography Technologist..... 2

 1.5.2 Radiologists, Surgeons 2

 1.5.3 Medical Physicist 2

1.6 Training Requirements..... 3

1.7 Quality Control Requirements..... 3

1.8 Where to Find the Installation Instructions..... 3

1.9 Where to Find Technical Description Information..... 3

1.10 Warranty Statement..... 3

1.11 Technical Support 4

1.12 Product Complaints..... 4

1.13 Hologic Cybersecurity Statement..... 4

1.14 Descriptions of Warnings, Cautions, and Notes 4

2: General Information _____ **5**

2.1 System Overview 5

 2.1.1 C-Arm Overview 6

2.2 Safety Information 7

2.3 Warnings and Precautions..... 7

2.4 Emergency Off Switches 11

2.5 Interlocks..... 11

2.6 Compliance..... 11

 2.6.1 Compliance Requirements 11

 2.6.2 Compliance Statements..... 13

2.7 Symbols 14

2.8 Label Locations 16

3: System Controls and Indicators _____ **19**

3.1 System Power Controls..... 19

3.2 C-Arm Controls..... 20

 3.2.1 Biopsy Arm Controls..... 21

Affirm Prone Biopsy System User Guide

Table of Contents

3.2.2	Control Handle Controls.....	22
3.2.3	Footswitch Controls.....	22
3.3	Patient Platform Controls	23
3.4	Acquisition Workstation Controls.....	24
4:	Startup, Functional Tests, and Shutdown	25
4.1	How to Start the System.....	25
4.1.1	Log In.....	26
4.2	Functional Tests.....	27
4.2.1	Compression Functional Tests	27
4.2.2	C-arm Movement Functional Tests	27
4.2.3	Patient Platform Functional Tests.....	28
4.3	How to Shut Down the System.....	28
4.3.1	How to Remove All Power from the System	28
5:	User Interface - Control Monitor	29
5.1	Select Function to Perform Screen	29
5.2	How to Change the Language.....	30
5.3	About the Taskbar.....	31
5.4	The Select Patient Screen.....	32
5.4.1	How to Open a Patient.....	33
5.4.2	How to Add a New Patient	34
5.4.3	How to Edit the Patient Information.....	34
5.4.4	How to Delete a Patient Manually.....	34
5.4.5	The Patient Filter Screen	35
5.4.6	How to Refresh the Worklist.....	36
5.4.7	How to Query the Worklist.....	36
5.4.8	About the Admin Button	36
5.5	The Procedure Screen.....	37
5.5.1	How to Use the Implant Present Button.....	38
5.5.2	How to Add a Procedure	38
5.5.3	How to Add or Remove a View.....	39
5.5.4	How to Edit a View.....	40
5.5.5	Procedure Information Dialog Box.....	41
5.5.6	How to Close a Procedure	41
5.6	How to Use the Output Groups.....	42
5.6.1	How to Select an Output Group	42
5.6.2	How to Add or Edit an Output Group	42
5.6.3	How to Use the Custom Output	43
5.7	How to Use the On-Demand Outputs	44
5.7.1	How to Archive.....	44
5.7.2	How to Export	45
5.7.3	How to Print	46

6: User Interface - Biopsy Control Module	49
6.1 Biopsy Control Module Display	49
6.1.1 Home Screen.....	49
6.1.2 Target Guidance Screen	50
7: Images	55
7.1 Introduction.....	55
7.1.1 Conventional Imaging Sequence of Events.....	56
7.1.2 Tomosynthesis Imaging Sequence of Events	56
7.2 How to Acquire an Image.....	56
7.3 How to Review the Images.....	58
7.3.1 The Image Review Tools Tab	59
7.3.2 Other Image Review Tools	60
7.3.3 Slice Indicator	61
7.3.4 How to Correct and Reprocess Implant Images.....	61
8: Biopsy	63
8.1 Biopsy Approach	63
8.2 Biopsy Coordinate System.....	64
8.3 Biopsy Tab	65
8.3.1 Biopsy Options.....	66
8.4 Stereotactic Lesion Targeting	68
8.4.1 Lateral Approach	69
8.4.2 Verify the Position of the Biopsy Device	69
8.5 Lesion Targeting with Tomosynthesis.....	70
8.5.1 Lateral Approach	70
8.5.2 Verify the Position of the Biopsy Device	71
8.5.3 Project Targets on Post-Tomographic Scout Image	71
8.6 Lesion Targeting Using Multi-Pass	72
8.7 Post Biopsy.....	75
9: System Administration Interface	77
9.1 The About Screen.....	77
9.2 The Admin Screen	78
9.3 How to Access the System Tools	80
9.3.1 System Tools for the Radiologic Technologist Manager	81
9.3.2 Remote Access to Image Reports.....	82
9.4 How to Use the Archive Tool.....	84
10: Accessories	87
10.1 Maximum Comfort Package	87
10.2 Paddles	90
10.2.1 How to Install or Remove a Paddle.....	91

Affirm Prone Biopsy System User Guide

Table of Contents

10.3	Compatible Biopsy Devices	92
10.3.1	Biopsy Device Holder.....	92
10.3.2	Needle Guides	93
10.3.3	Install a Biopsy Device on a Device Holder	94
11:	Sample Clinical Sequences	95
11.1	Example Stereotactic Biopsy Procedure.....	95
11.2	Example Tomography Biopsy Procedure.....	96
11.3	Example Sequence of Operation	97
12:	Quality Assurance	103
12.1	Recommended Tests	104
12.2	QAS Test.....	105
12.3	Gain Calibration.....	107
12.4	Geometry Calibration.....	108
13:	Care and Cleaning	109
13.1	Cleaning	109
13.1.1	General Information About Cleaning	109
13.1.2	For General Cleaning.....	109
13.1.3	How to Clean the Biopsy Control Module Screen.....	110
13.1.4	To Prevent Possible Injury or Equipment Damage	110
13.2	Preventive Maintenance Schedule.....	111
Appendix A:	System Specifications	113
A.1	Product Measurements	113
A.2	Operation and Storage Environment	114
A.2.1	General Conditions for Operation.....	114
A.2.2	General Conditions for Transport and Storage.....	114
A.3	Electrical Input	115
A.3.1	Generator/Gantry	115
A.3.2	Acquisition Workstation.....	115
A.4	Gantry Technical Information.....	115
A.4.1	C-arm	115
A.4.2	Compression System	115
A.4.3	Biopsy Guidance Module	115
A.4.4	X-ray Tube.....	116
A.4.5	X-ray Beam Filtration and Output.....	116
A.4.6	X-ray Generator.....	117
A.4.7	Image Receptor Technical Information.....	117
A.5	Acquisition Workstation Technical Information	117
A.5.1	Network Environment	117
A.5.2	Acquisition Workstation Cart	117

Appendix B: System Messages and Alerts	119
B.1 Error Recovery and Troubleshooting.....	119
B.2 Types of Messages	119
B.2.1 Fault Levels.....	119
B.2.2 System Messages.....	120
B.3 UPS Messages.....	121
Appendix C: Dose Information	123
C.1 AEC Technique Tables	123
Appendix D: Hologic Biopsy Devices	125
D.1 Hologic Factory-Verified Biopsy Devices.....	125
Appendix E: Forms	127
E.1 QAS Test Checklist	127
Glossary of Terms	129
Index	131

List of Figures

Figure 1: Affirm Prone Biopsy System.....	5
Figure 2: C-arm Overview	6
Figure 3: Emergency Off Switch Functionality.....	11
Figure 4: Label Locations.....	16
Figure 5: System Power Controls	19
Figure 6: C-arm Controls and Displays	20
Figure 7: Biopsy Arm – Detailed View	21
Figure 8: Control Handle -- Detailed View	22
Figure 9: Footswitch – Detailed View	22
Figure 10: Patient Platform Controls.....	23
Figure 11: Acquisition Workstation Controls	24
Figure 12: Startup Screen.....	25
Figure 13: Select an Operator (Log In) Screen.....	26
Figure 14: Select Function to Perform Screen.....	29
Figure 15: Select Patient Screen.....	32
Figure 16: Add Patient Screen.....	34
Figure 17: Filter Tab in the Patient Filter Screen.....	35
Figure 18: Procedure Screen.....	37
Figure 19: Add Procedure Dialog Box	38
Figure 20: Add View Screen.....	39
Figure 21: Edit View Screen.....	40
Figure 22: The Procedure Info Window	41
Figure 23: Output Groups Field.....	42
Figure 24: An Example Custom Output Group.....	43
Figure 25: On Demand Archive Screen	45
Figure 26: Print Screen	47
Figure 27: Home Screen	49
Figure 28: Target Guidance Screen.....	50
Figure 29: Select Target Screen.....	52
Figure 30: Jog Mode Screen	53
Figure 31: AEC Adjust Screen.....	54
Figure 32: Image Display Screen.....	55
Figure 33: Exposure in Progress	57
Figure 34: Exposure Complete	57
Figure 35: Tools Tab	58
Figure 36: Image Review Tools.....	59
Figure 37: Exposure Index	60
Figure 38: Display Modes	60
Figure 39: Slice Indicator.....	61
Figure 40: Biopsy Arm Angles of Rotation.....	63
Figure 41: X, Y, Z Axes.....	64
Figure 42: Biopsy Tab.....	65

Affirm Prone Biopsy System User Guide

Table of Contents

Figure 43: Function Buttons and Data on the Biopsy Tab	66
Figure 44: Multi-Pass Options	72
Figure 45: Four Offset Target Points Established Around Center Target Point.....	73
Figure 46: 3 mm Spacing of Offset Points.....	73
Figure 47: 5 mm Spacing of Offset Points.....	73
Figure 48: Single Point Target Selected.....	74
Figure 49: Single Point Target Deselected	74
Figure 50: Multi-Pass Target Selected	74
Figure 51: Multi-Pass Target Deselected.....	74
Figure 52: Example of Biopsy Order of Target Sets	74
Figure 53: Biopsy Order of a Three Offset Target.....	75
Figure 54: Biopsy Order of a Four Offset Target	75
Figure 55: Biopsy Order of a Five Offset Target	75
Figure 56: About Screen with the System Tab Showing.....	77
Figure 57: Admin Screen.....	78
Figure 58: The System Tools Screen	81
Figure 59: Remote Logon Screen for Service Tools	82
Figure 60: Service Tools Welcome Screen.....	82
Figure 61: Create Image Report Parameters.....	83
Figure 62: Create Image Report	83
Figure 63: Archive Button.....	84
Figure 64: Multi Patient On Demand Archive Screen.....	84
Figure 65: Export Screen	86
Figure 66: How to Install a Compression Paddle	91
Figure 67: How to Install the Biopsy Device Holder.....	92
Figure 68: How to Install the Needle Guides.....	93
Figure 69: Install the Biopsy Device in the Device Holder.....	94
Figure 70: Admin Screen.....	105
Figure 71: Device Field in the Biopsy Tab	105
Figure 72: Admin Screen.....	107
Figure 73: Admin Screen.....	108
Figure 74: Gantry and Generator Dimensions	113
Figure 75: Acquisition Workstation Dimensions.....	114
Figure 76: UPS LCD Display	121

List of Tables

Table 1: System Labels	17
Table 2: Compression Tests	27
Table 3: C-arm Tests	27
Table 4: Patient Platform Tests.....	28
Table 5: Taskbar Menus	31
Table 6: The Select Patient Screen.....	32
Table 7: The Filter Tab Options (Require Access Privileges).....	36
Table 8: The Procedure Screen	37
Table 9: Admin Screen Functions.....	79
Table 10: Radiologic Technologist Manager—System Tools Functions.....	81
Table 11: Installation and Use of the Maximum Comfort Package	87
Table 12: Installation of the Arm Through Maximum Comfort Package	89
Table 13: Use of the Arm Through Maximum Comfort Package.....	90
Table 14: Recommended Tests	104
Table 15: Operator Preventive Maintenance Schedule.....	111
Table 16: Maximum mA as a Function of kV.....	116
Table 17: System Messages	120
Table 18: AEC Table - Standard Dose	123
Table 19: Hologic Factory-Verified Biopsy Devices.....	125

Chapter 1 Introduction

1.1 Preface

Read all of this information carefully before installation and operation. Follow all warnings and precautions as stated in this manual. Keep this manual available during procedures. Physicians should tell patients about all potential risks and adverse events described in this manual with respect to the operation of the system.

1.2 Intended Use

R_xOnly Caution: Federal law restricts this device to sale by or on the order of a physician.

The Affirm™ Prone Biopsy System is intended for lesion location for biopsy while the patient is in the prone position to provide guidance for interventional purposes (such as biopsy, pre-surgical localization or treatment devices).

1.2.1 Indications for Use

The Affirm Prone Biopsy System combines the function of a standard x-ray mammography unit with that of a lesion localization system to produce a device that has specific application in first accurately localizing lesions in the breast in two and/or three dimensions, and then providing guidance for interventional purposes (such as biopsy, pre-surgical localization or treatment devices) for lesions determined to be suspicious through prior mammographic examination.

1.2.2 Contraindications

- Patient weighs more than 181 kg (400 pounds).
- Inability to visualize the lesion under mammographic imaging.
- Patient cannot remain in a prone position during the entire procedure.

1.3 Essential Performance

The essential performance requirements of the Affirm Prone Biopsy System is as defined in IEC-60601-2-45: 2005. These include: accuracy of loading factors, automatic control system, imaging performance, missed tissue at chest wall side, breast compression device, linearity of air kerma over limited intervals of loading factors, and reproducibility of the X-radiation output.

1.4 System Capabilities

The Affirm Prone Biopsy System is a tomosynthesis-capable mammography system for performing breast biopsies on patients lying in the prone position. The system localizes suspicious lesions, as determined through prior mammographic examinations, using either stereotactic or tomosynthesis techniques. The system then affords a physician the capacity of performing vacuum-assisted needle core biopsy or needle (wire) localization of the lesion.

Localization can be accomplished either via conventional stereotactic imaging, or by examination of a tomosynthesis data set. With tomosynthesis, the image plane or “slice” most fully containing the suspected lesion is chosen by the physician from the data set to identify the lesion depth within the breast.

1.5 User Profiles

1.5.1 Mammography Technologist

- Meets all requirements that apply to the location in which the Mammography Technologist operates.
- Completed training on the mammography system.
- Has training in mammography positions.
- Understands stereotactic breast biopsy procedures.
- Understands how to operate a computer and its peripherals.
- Understands sterile procedures.

1.5.2 Radiologists, Surgeons

- Meets all requirements that apply to the location in which the Physician operates.
- Understands stereotactic breast biopsy procedures.
- Understands how to operate a computer and its peripherals.
- Understands sterile procedures.
- Gives local anesthesia.
- Understands basic surgical procedures for core biopsy.

1.5.3 Medical Physicist

- Meets all requirements that apply to the location in which the Medical Physicist operates.
- Understands mammography.
- Has experience with digital imaging.
- Understands how to operate a computer and its peripherals.

1.6 Training Requirements

In the United States, users must be Registered Radiologic Technologists meeting criteria to perform mammography. The mammography users must meet all applicable MQSA personnel requirements under FDA guidelines for conventional and digital mammography.

The user has options available for training, which include but are not limited to:

- Onsite applications training by a Hologic Clinical Services Specialist
- Onsite on the job training also known as peer training

Additionally, the user manual is a guide for directions on how to use the system.

All users must make sure that they receive training on correct operation of the system before use on patients.

Hologic does not accept the responsibility for injury or damage from wrong system operation.

1.7 Quality Control Requirements

Perform all Quality control tests within the correct time frame.

1.8 Where to Find the Installation Instructions

Installation instructions are available in the Service Manual.

1.9 Where to Find Technical Description Information

Technical description information is available in the Service Manual.

1.10 Warranty Statement

Except as otherwise expressly stated in the Agreement: i) Equipment manufactured by Hologic is warranted to the original Customer to perform substantially in accordance with published product specifications for one (1) year starting from the date of shipment, or if Installation is required, from the date of Installation (“Warranty Period”); ii) digital imaging mammography x-ray tubes are warranted for twenty-four (24) months, during which the x-ray tubes are fully warranted for the first twelve (12) months and are warranted on a straight-line prorated basis during months 13-24; iii) replacement parts and remanufactured items are warranted for the remainder of the Warranty Period or ninety (90) days from shipment, whichever is longer; iv) consumable Supplies are warranted to conform to published specifications for a period ending on the expiration date shown on their respective packages; v) licensed Software is warranted to operate in accordance with published specifications; vi) Services are warranted to be supplied in a workman-like manner; vii) non-Hologic Manufactured Equipment is warranted through its manufacturer and such manufacturer’s warranties shall extend to Hologic’s customers, to the extent permitted by the manufacturer of such non-Hologic Manufactured Equipment. Hologic does not warrant that use of Products will be uninterrupted or error-free, or that Products will operate with non-Hologic authorized third-party products.

1.11 Technical Support

Refer to the title page of this manual for contact information for product support.

1.12 Product Complaints

Report any complaints or problems in the quality, reliability, safety, or performance of this product to Hologic. If the device has caused or added to patient injury, immediately report the incident to Hologic.

1.13 Hologic Cybersecurity Statement

Hologic continuously tests the current state of computer and network security to examine possible security problems. When necessary, Hologic provides the updates to the product.

For Cybersecurity Best Practices documents for Hologic products, refer to the Hologic Internet site.

1.14 Descriptions of Warnings, Cautions, and Notes

Descriptions of Warnings, Cautions, and Notes used in this manual:



WARNING!

The procedures that you must follow accurately to prevent possible dangerous or fatal injury.



Warning:

The procedures that you must follow accurately to prevent injury.



Caution:

The procedures that you must follow accurately to prevent damage to equipment, loss of data, or damage to files in software applications.



Note

Notes show additional information.

Chapter 2 General Information

2.1 System Overview

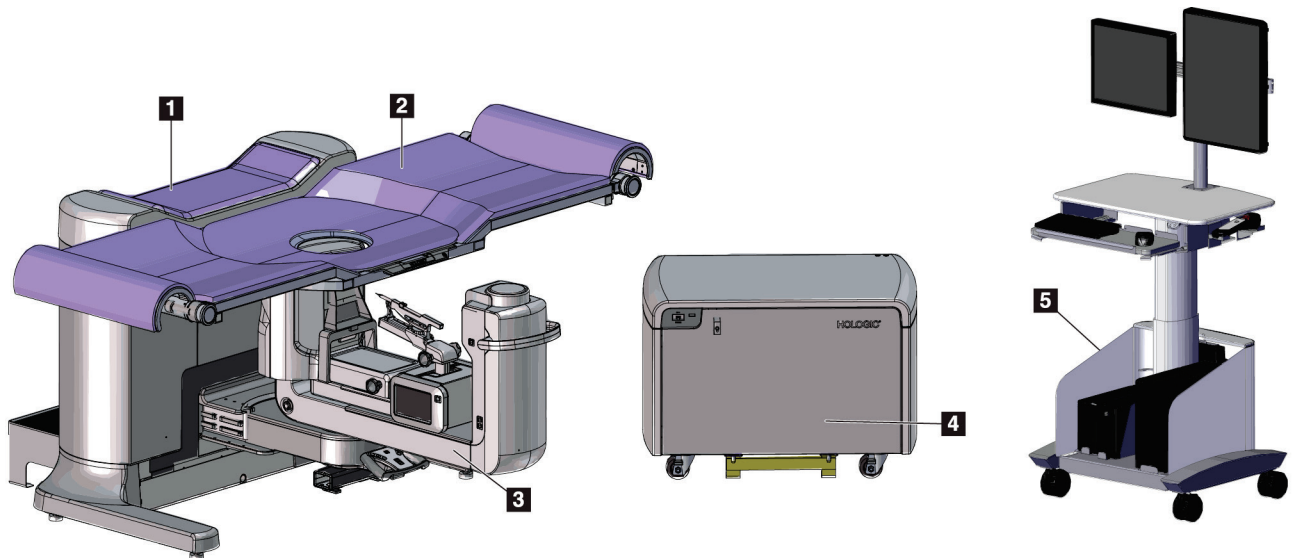

Figure 1: Affirm Prone Biopsy System

Figure Legend

1. Gantry
2. Patient Support Platform
3. C-Arm
4. High Voltage Generator
5. Acquisition Workstation



Note

The Acquisition Workstation has wheels for ease of positioning only. The system is NOT a mobile unit.

2.1.1 C-Arm Overview

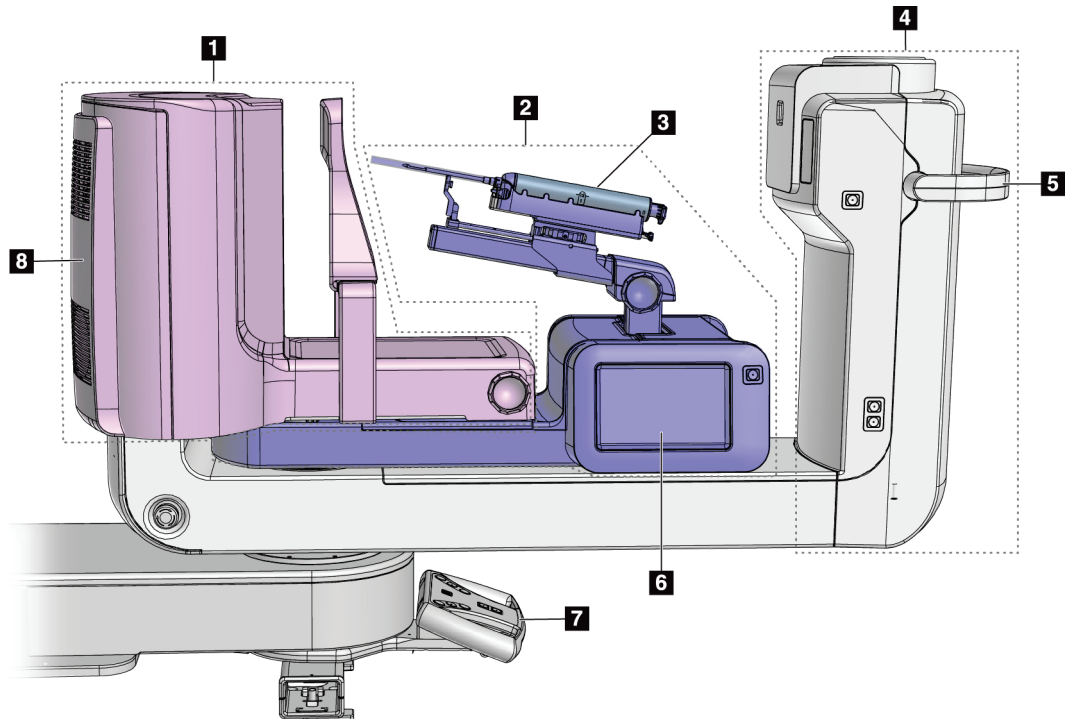

Figure 2: C-arm Overview

Figure Legend

- 1. Compression Arm
- 2. Biopsy Arm
- 3. Biopsy Device
- 4. Tubehead
- 5. C-arm Rotation Handle
- 6. Biopsy Control Module Display
- 7. Control Handle
- 8. Image Receptor

2.2 Safety Information

Read and understand this manual before you use the system. Keep the manual available during the patient procedures.

Always follow all the instructions in this manual. Hologic does not accept the responsibility for injury or damage from incorrect system operation. Hologic can schedule training at your facility.

The system has protective devices, but the Technologist must understand how to safely use the system. The Technologist must remember the health hazards of x rays.

2.3 Warnings and Precautions



This system is classified as CLASS I, TYPE B APPLIED PART, IPX0, permanently connected equipment, continuous operation with short term loading per IEC 60601-1. There are no special provisions to protect the system from flammable anesthetics or ingress of liquids.

APPLIED PARTS include Compression Paddles, Breast Platform, and Patient Platform.



WARNING!

Risk of electric shock. Only connect this equipment to supply mains with Protective Earth.



WARNING!

For North American electrical safety requirements, use a Hospital Grade receptacle to supply a correct Ground.



WARNING!

Electrical equipment used near flammable anesthetics can cause an explosion.



WARNING!

To correctly isolate the system, attach only approved accessories or options to the system. Only approved personnel can change the connections.



WARNING!

Keep a 1.5 meter safe distance between the patient and any non-patient devices.

Do not install non-patient system components (like the Workflow Manager, a diagnostic review workstation, or a hard copy printer) in the Patient Area.



WARNING!

Keep a 1.5 meter safe distance between the patient platform and the acquisition workstation.



WARNING!

Only trained Service Engineers authorized through Hologic can open any of the panels. This system contains lethal voltages.



WARNING!

The user must correct problems before the system is used. Contact an approved service representative for preventive maintenance.



WARNING!

After power failure, remove the patient from the system before you apply power.



Warning:

This device contains dangerous material. Send decommissioned material to Hologic or contact your service representative.



Warning:

C-arm movement is motorized.



Warning:

You increase the patient dose to high levels when you increase the AEC exposure adjustment. You increase the image noise or decrease image quality when you decrease the AEC exposure adjustment.



Warning:

Control the access to the equipment according to local regulations for radiation protection.



Warning:

The disk drives installed in this system are a Class I Laser Product. Prevent direct exposure to the beam. Hidden laser radiation exists if the case to a disk drive is open.



Warning:

Keep your full body behind the radiation shield during the exposure.



Warning:

Do not move the C-arm while the system retrieves the image.



Warning:

If a paddle touches possible infectious materials, contact your Infection Control Representative to remove contamination from the paddle.



Warning:

Do not leave the patient unattended during the procedure.



Warning:

Keep the hands of the patient away from all buttons and switches at all times.



Warning:

Place each footswitch in a position where, when used, they remain in reach of the Emergency Off Switches.



Warning:

Position the footswitches to prevent accidental operation by a patient or wheelchair.



Warning:

To prevent a higher radiation dose to the patient, only put approved materials in the x-ray beam path.



Warning:

This system can be dangerous to the patient and the user. Always follow the safety precautions for x-ray exposures.



Warning:

Use protective radiation shielding with a lead equivalent of more than .08 mm.

Affirm Prone Biopsy System User Guide

Chapter 2: General Information



Warning:
Do not sit on or step on the generator.



Caution:
The system is a medical device and not a normal computer. Only make approved changes to the hardware or software. Install this device behind a firewall for network security. The computer virus protection or network security for this medical device is not supplied (for example, a computer firewall). The network security and anti-virus provisions are the responsibility of the user.



Caution:
Do not turn off the Acquisition Workstation circuit breaker except in emergency. The circuit breaker can turn off the Uninterruptible Power Supply (UPS) and risk data loss.



Caution:
Risk of data loss. Do not put any magnetic media near or on devices that create any magnetic fields.



Caution:
Do not use any heat source (like a heating pad) on the image receptor.



Caution:
Do not block or cover the fan ports located on the rear cover of the Digital Image Receptor.



Caution:
To prevent possible damage from thermal shock to the Digital Image Receptor, follow the recommended procedure to turn off the equipment.



Caution:
The display is calibrated for compliance to DICOM standards. Do not make any brightness or contrast adjustments to the display.



Caution:
Use the least possible amount of cleaning fluids. The fluids must not flow or run.



Caution:
To prevent damage to the electronic components, do not use disinfectant sprays on the system.

2.4 Emergency Off Switches

A red Emergency Off (E-Stop) switch is located on each side of the tube arm and on the x-ray remote control. The Emergency Off switch disables C-arm and Patient Platform movement and removes power from the Gantry.

Do NOT use the E-Stop switches for routine system shutdown.

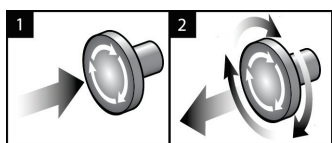

Figure 3: Emergency Off Switch
Functionality

1. Press any of the Emergency Off switches to power OFF the Gantry.
2. To reset the Emergency Off switch, turn clockwise approximately one-quarter turn until the switch pops back out.

2.5 Interlocks

- The electronic System Lock only allows C-arm movement when the **System Lock** button on the Control Handle is in unlocked mode.
- The system does not allow x-ray exposure unless in a Ready state and the **System Lock** button on the Control Handle is in locked mode.
- If the x-ray button is released before the end of the exposure, the exposure stops and an alarm message shows.
- The system does not enter a Ready state following an exposure until the x-ray button is released.

2.6 Compliance

This section describes the system compliance requirements and the responsibilities of the manufacturer.

2.6.1 Compliance Requirements

The manufacturer has the responsibility for the safety, reliability, and performance of this equipment with the following provisions:

- The electrical installation of the room meets all requirements.
- The equipment is used according to the *User Guide*.
- The assembly operations, extensions, adjustments, changes, or repairs are performed only by authorized persons.
- The network and communication equipment is installed to meet IEC Standards. The complete system (network and communications equipment and the Affirm Prone Biopsy System) must be in compliance with IEC 60601-1.

Affirm Prone Biopsy System User Guide

Chapter 2: General Information



Caution:

Medical Electrical Equipment needs special precautions about EMC and must be installed, put into service and used according to the EMC information provided.



Caution:

Portable and mobile RF communications can affect medical electrical equipment.



Caution:

The use of unauthorized accessories and cables can result in increased emissions or decreased immunity. To keep the isolation quality for the system, attach only approved Hologic accessories or options to the system.



Caution:

The Medical Electrical (ME) Equipment or ME System should not be used adjacent to or stacked with other equipment. If adjacent or stacked use is necessary, make sure that the ME Equipment or ME System operates correctly in this configuration.



Caution:

This system is intended for use by healthcare professionals only. This system may cause radio interference or may disrupt the operation of nearby equipment. It may be necessary to take mitigation measures, such as re-orienting or relocating the equipment or shielding the location.



Caution:

Changes or modifications not expressly approved by Hologic could void your authority to operate the equipment.



Caution:

This equipment has been tested and found to comply with the limits for a Class A digital device, pursuant to part 15 of the FCC Rules. These limits are designed to provide reasonable protection against harmful interference when the equipment is operated in a commercial environment. This equipment generates, uses, and can radiate radio frequency energy and, if not installed and used in accordance with the instruction manual, may cause harmful interference to radio communications. Operation of this equipment in a residential area is likely to cause harmful interference in which case the user will be required to correct the interference at his own expense.

2.6.2 Compliance Statements

The manufacturer states this device is made to meet the following requirements.

IEC:

- IEC 60601-1: 2005 - Medical Electrical Equipment, Part 1: General requirements for basic safety and essential performance
- IEC 60601-1-2: 2007 - Collateral standard: Electromagnetic compatibility - Requirements and tests
- IEC 60601-1-3: 2008 - General requirements for radiation protection in diagnostic x-ray equipment
- IEC 60601-1-6: 2010 - Collateral Standard: Usability
- IEC 60601-2-28: 2010 - Particular requirements for the basic safety and essential performance of x-ray tube assemblies for medical diagnosis
- IEC 60601-2-45: 2011 - Particular requirements for the basic safety and essential performance of mammographic x-ray equipment and mammographic stereotactic devices

FDA:

- 21 CFR §900 – Mammography Quality Standards Act (MQSA)
- 21 CFR §1020.30 – Diagnostic x-ray systems and their major components
- 21 CFR §1020.31 – Radiographic equipment

CE:

- 93/42/EEC – CE marking according to MDD
- 2006/42/EC – Machinery Directive of 17 May 2006
- 2002/95/EC – Restriction of Hazardous Substances Directive of 27 January 2003
- 2002/96/EC – Waste Electrical and Electronic Equipment Directive of 27 January 2003

CAN/CSA:















- CAN/CSA-C22.2 No. 60601-1 (2008): Medical electrical equipment - Part 1: General requirements for safety















ANSI/AAMI:

- ANSI/AAMI ES60601-1 (2005) - Medical electrical equipment— Part 1: General requirements for basic safety and essential performance

2.7 Symbols

This section describes the Symbols on this system.

Symbol	Description
	Type B Applied Part
	Potential Equalization terminal
	Protective Earth terminal
	"OFF" (power)
	"ON" (power)
	"OFF" for part of the equipment
	"ON" for part of the equipment
	Discard electrical and electronic equipment separately from standard waste. Send decommissioned material to Hologic or contact your service representative.
	Dangerous Voltage
	Manufacturer
	Date of Manufacture
	This system transmits radio frequency (RF) energy (non-ionizing radiation)
	Wi-Fi connection
	Caution—Radiation
	Alternating current

Symbol	Description
	Follow operating instructions
	Follow the <i>User Guide</i>
	Caution
	Fragile, handle with care
	Temperature limit
	Humidity limitation
	Atmospheric pressure limitation
	Do not immerse in any liquid
	No pushing
	No stepping on surface
	No sitting
	Combined weight of the equipment and its safe working load
	Authorized representative in the European community
	Catalog number
	Serial Number

2.8 Label Locations

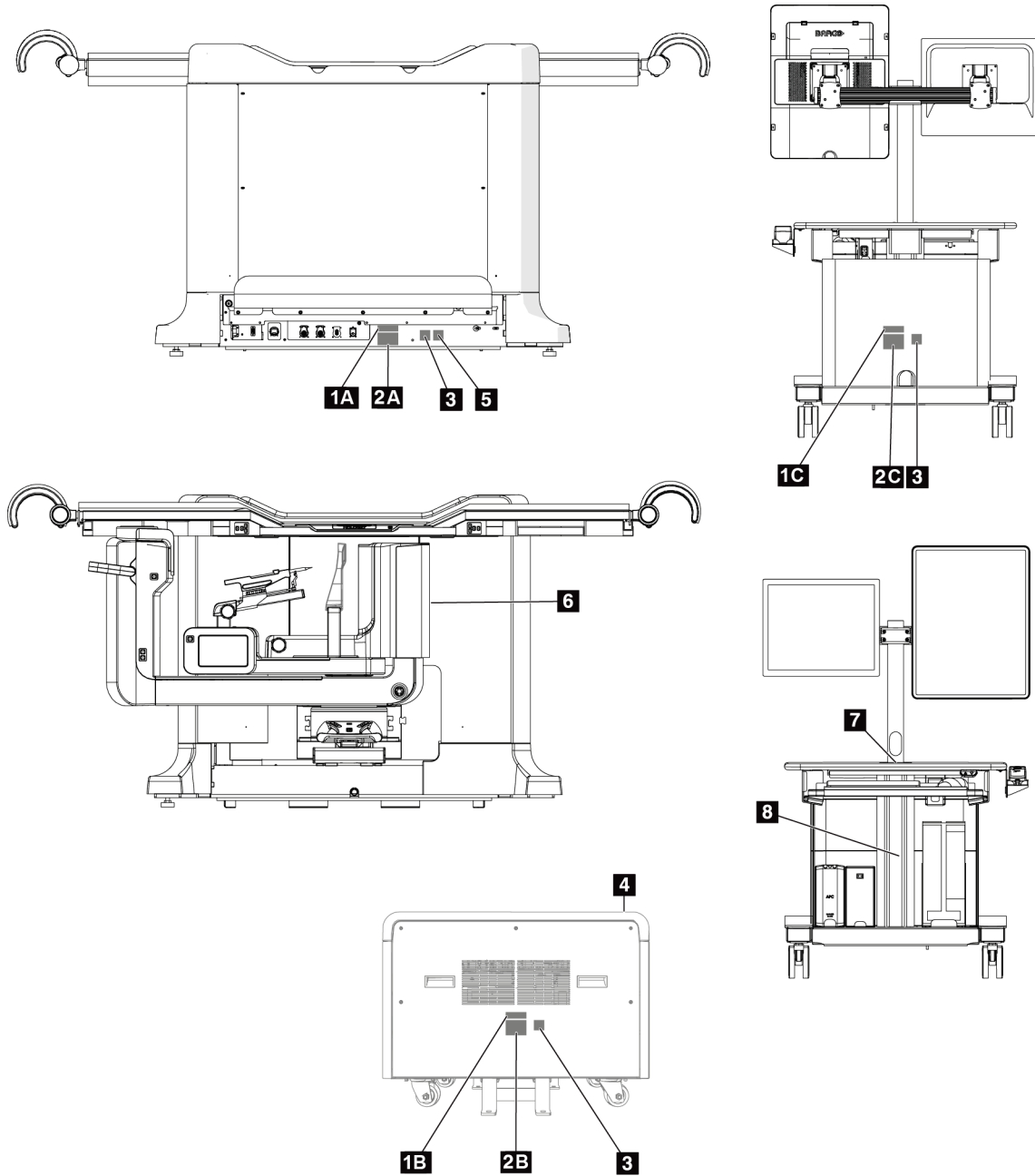

Figure 4: Label Locations

Table 1: System Labels

1A	1B	1C
<p>2A</p>	<p>2B</p>	<p>2C</p>
<p>3</p>	<p>4</p>	<p>5</p>
<p>6</p>	<p>7</p>	<p>8</p>

Chapter 3 System Controls and Indicators

3.1 System Power Controls

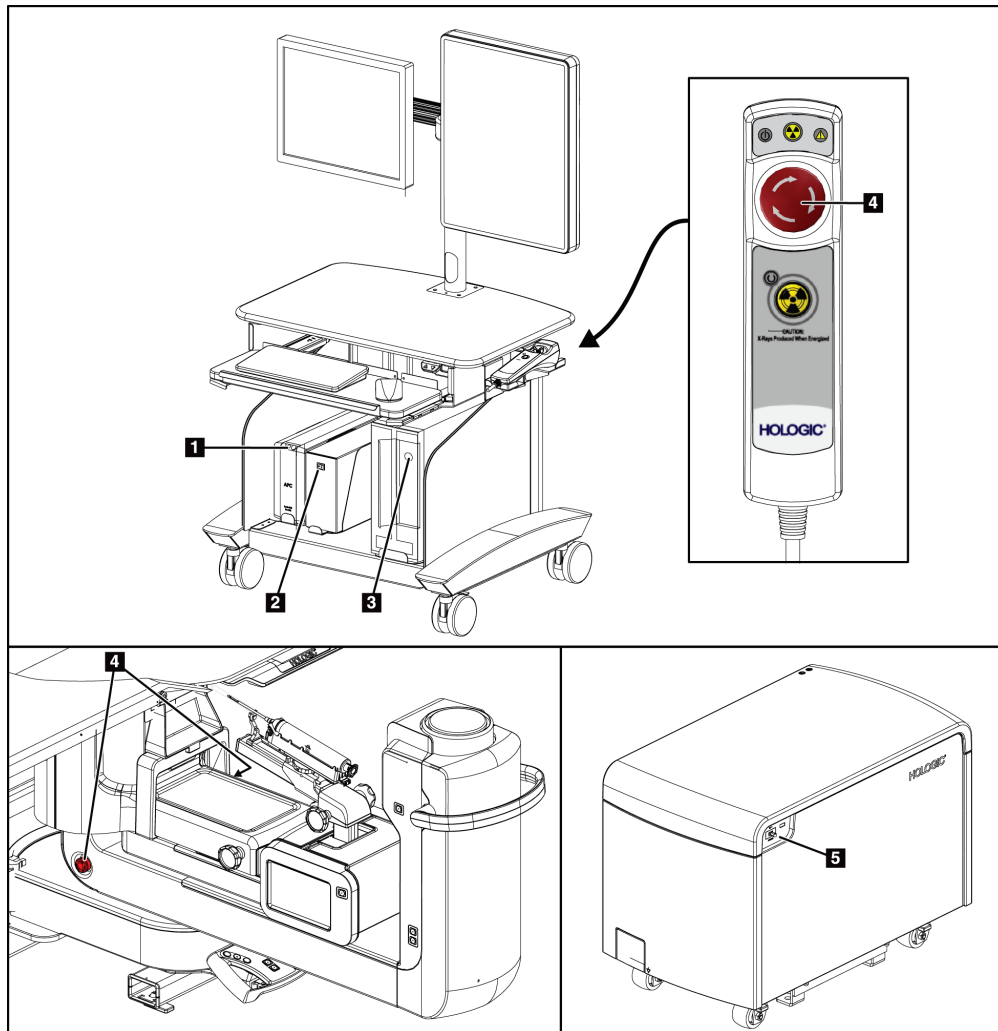

Figure 5: System Power Controls

Figure Legend

1. Uninterruptible Power Supply (UPS) Power/Reset Button
2. Isolation Transformer Power Switch
3. Computer Power On/Reset Button
4. Emergency Off (E-Stop) Switches
5. Generator Circuit Breaker

3.2 C-Arm Controls

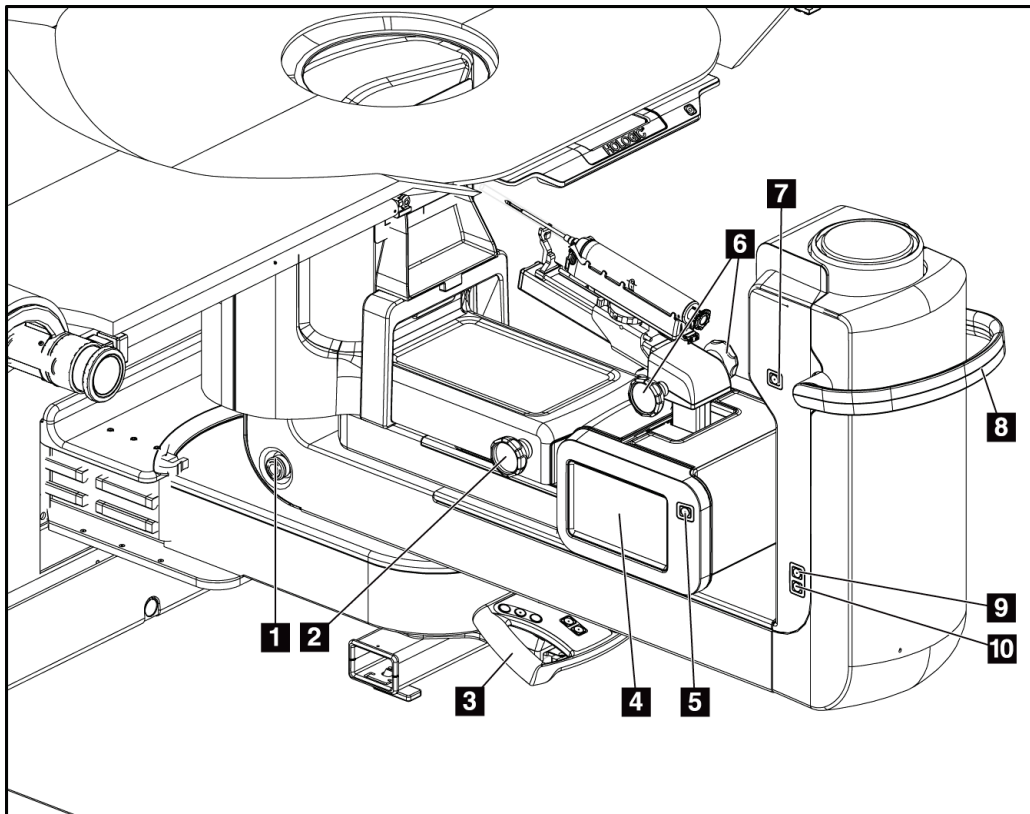

Figure 6: C-arm Controls and Displays

Figure Legend

1. Emergency Off (E-Stop) Switch
2. Manual Compression Adjust Knob
3. Control Handle
4. Biopsy Control Module Touchscreen Display
5. Biopsy Arm Motor Enable Button
6. Manual Biopsy Device Advance/Retract Knob
7. Task Lighting On/Off
8. C-arm Rotation Handle
9. C-arm Sweep – Away from User
10. C-arm Sweep – Toward User

3.2.1 Biopsy Arm Controls

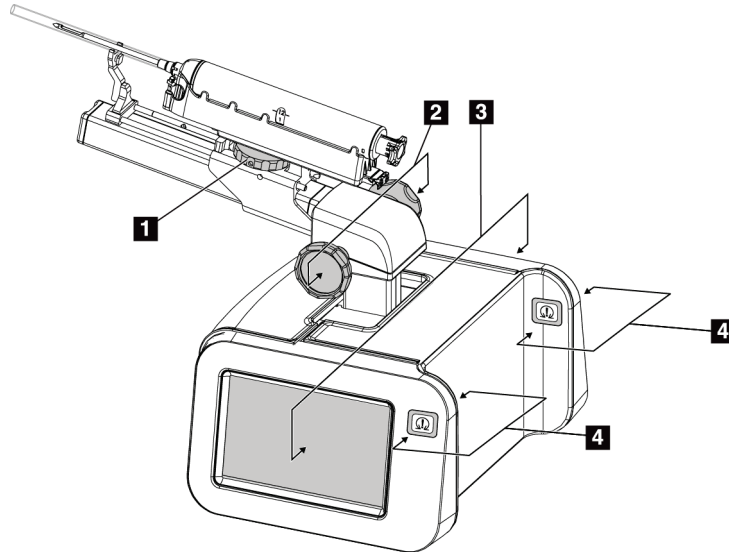

Figure 7: Biopsy Arm – Detailed View

Figure Legend

1. Biopsy Device Mount Knob
2. Manual Needle Advance/Retract Knobs
3. Biopsy Control Module Touchscreen Displays
4. Biopsy Control Module Motor Enable Buttons



Note

Refer to [User Interface - Biopsy Control Module](#) on page 49 for information on using the Biopsy Control Module touchscreen display.



Note

The Biopsy Control Module motor enable buttons consist of two pairs of buttons located on either side of the Biopsy Control Module. Each pair is located back to back on one of the module cover extensions and is meant to be pinched with one hand. To enable the Biopsy Control Module motor, press and hold one of the Motor Enable button pairs.

3.2.2 Control Handle Controls

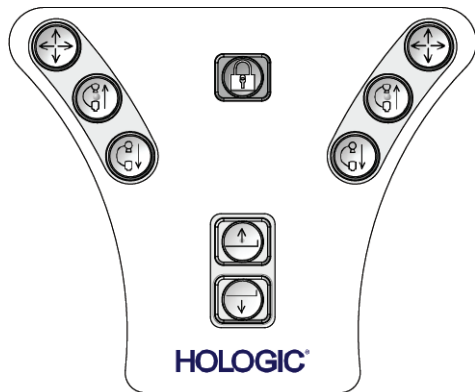

Figure 8: Control Handle -- Detailed View

Button	Function
	C-arm Translate (horizontal plane)
	C-arm Up
	C-arm Down
	System Lock
	Patient Platform Up
	Patient Platform Down

3.2.3 Footswitch Controls



Warning:

Place each footswitch in a position where, when used, they remain in reach of the Emergency Off Switches.



Warning:

Position the footswitches to prevent accidental operation by a patient or wheelchair.

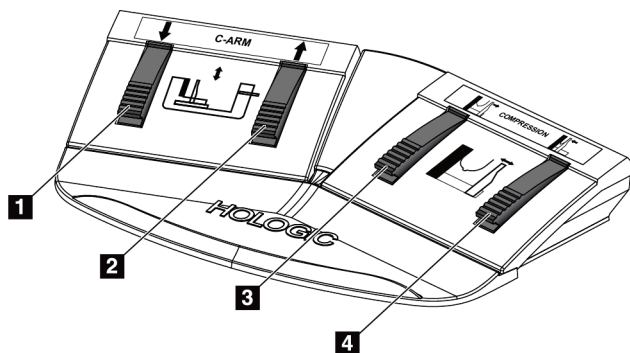

Figure 9: Footswitch – Detailed View

Figure Legend

1. C-arm Down
2. C-arm Up
3. Compression Release
4. Compression Apply

3.3 Patient Platform Controls

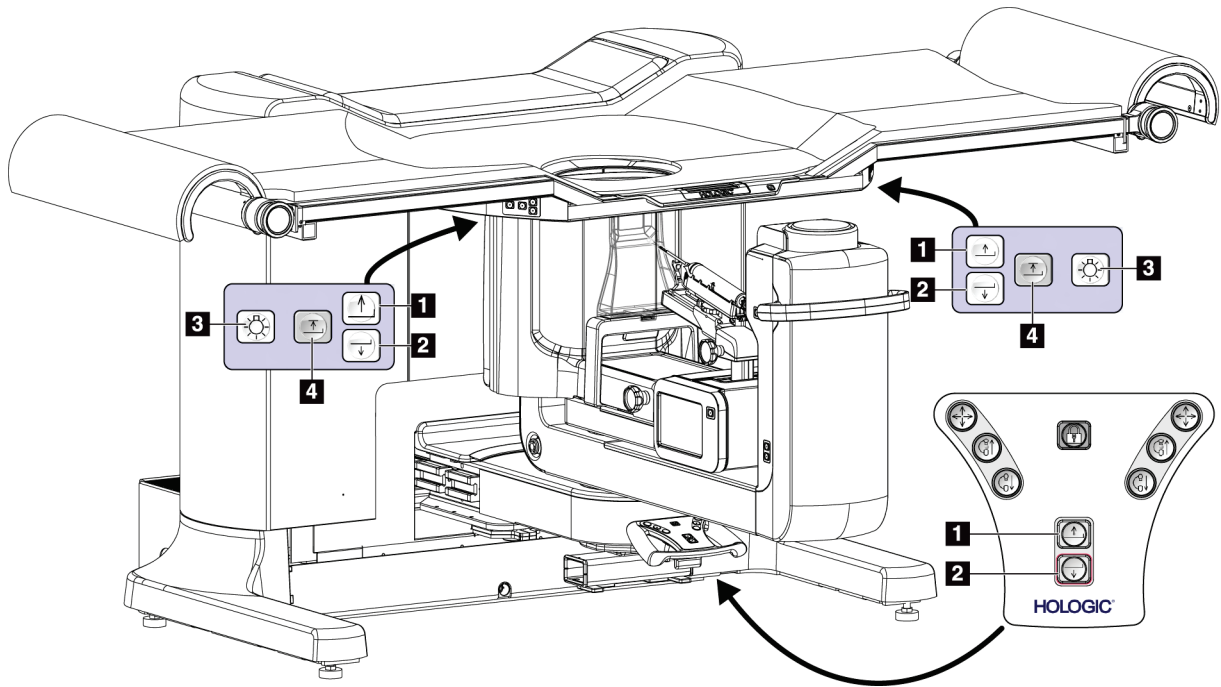

Figure 10: Patient Platform Controls

Figure Legend

1. Patient Platform Up
2. Patient Platform Down
3. Task Light On/Medium/Low/Off
4. Patient Platform Up Limit (Full Height)

3.4 Acquisition Workstation Controls

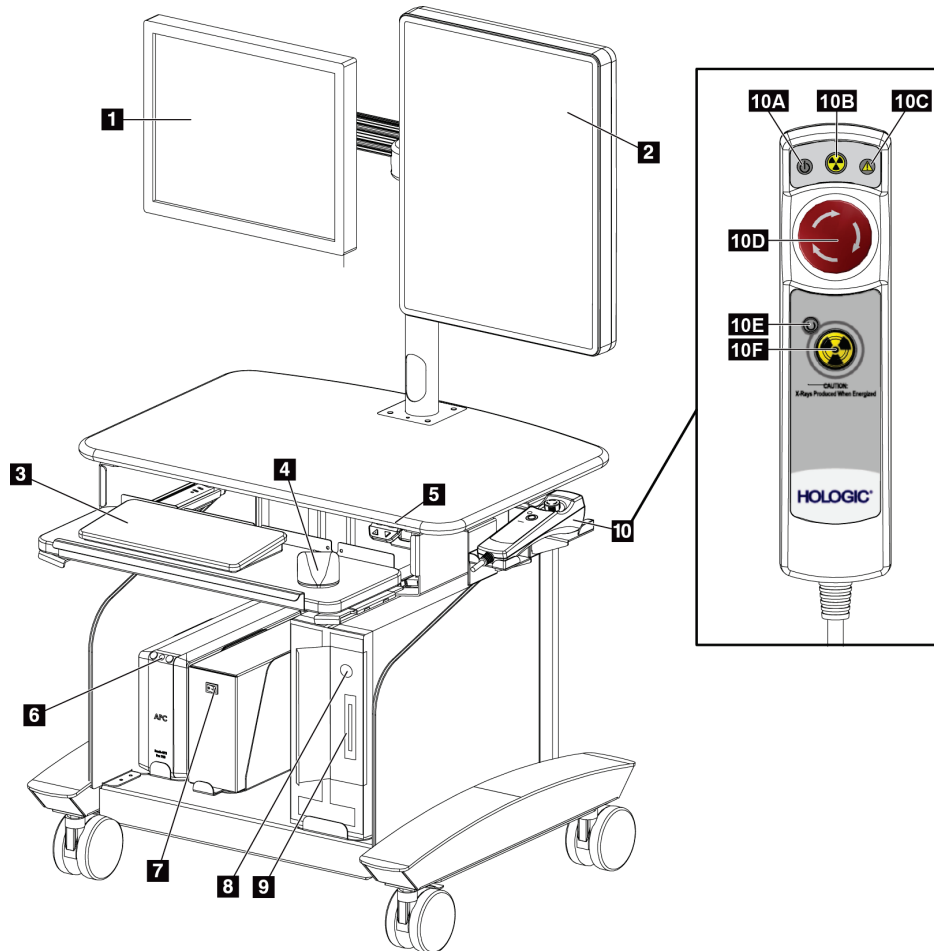

Figure 11: Acquisition Workstation Controls

Figure Legend

- | | |
|--|---|
| 1. Control Monitor | 9. CD/DVD Drive |
| 2. Image Display Monitor | 10. Emergency Off/X-ray Activation Remote |
| 3. Keyboard | A. Power On Light |
| 4. Mouse | B. X-ray Active Light |
| 5. Workstation Work Surface Up/Down Controls | C. System Alert Light |
| 6. Uninterruptible Power Supply (UPS) Power Button | D. Emergency Off Switch |
| 7. Isolation Transformer Power Switch | E. Ready for X-ray Light |
| 8. Computer Power On/Reset Button | F. X-ray Activation Button |

Chapter 4 Startup, Functional Tests, and Shutdown

4.1 How to Start the System

1. Verify that there are no obstructions to C-arm or Patient Platform movement.
2. Ensure that the Generator circuit breaker is in the ON position.
3. Ensure that the Isolation Transformer power switch is in the ON position.
4. Ensure that the UPS is powered ON.
5. Press the **Power/Reset** button on the computer. The computer powers on and the *Startup* screen appears on the Acquisition Workstation Control monitor. The Gantry then automatically powers on.

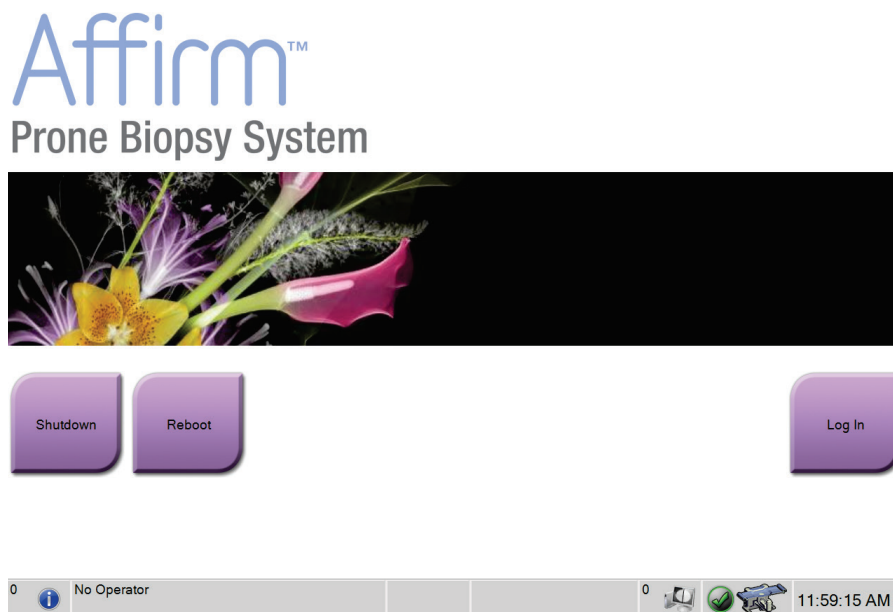

Figure 12: Startup Screen



Note

The *Startup* screen includes a **Shutdown** button that turns off the system, and a **Reboot** button that restarts the system.



Note

See the figure [System Power Controls](#) on page 19 for the locations of power buttons.

4.1.1 Log In

1. Select the **Log In** button on the *Startup* screen.
2. The *Select an Operator (Log In)* screen appears and shows a list of Manager and Technologist user names. Select the **Show All** button to list the Service, Applications, and Physicist user names.
3. Choose an operator by selecting the applicable button.

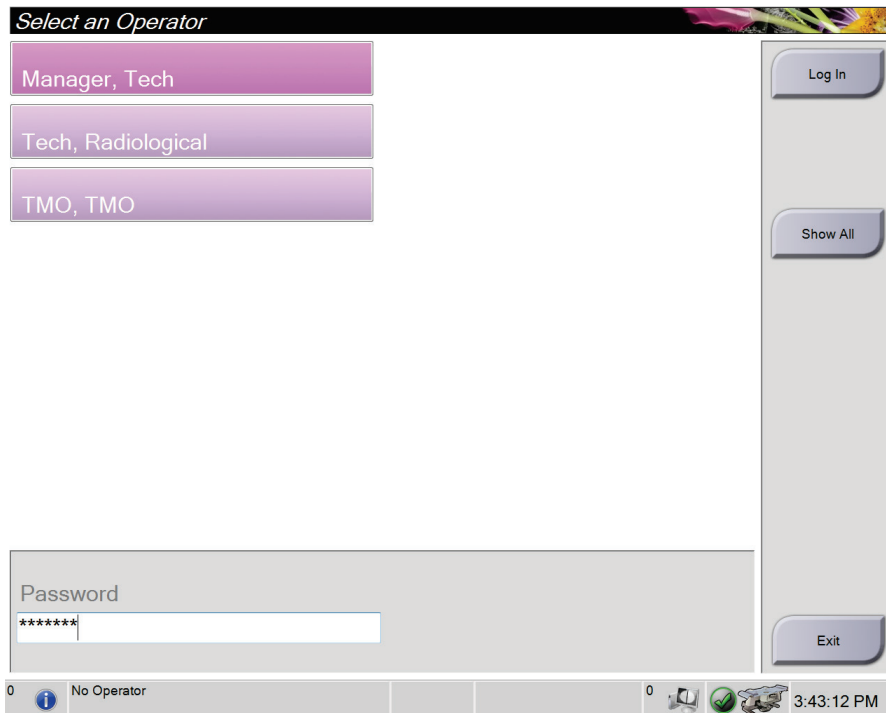

Figure 13: Select an Operator (Log In) Screen

4. Select the Password field and type in the password.
5. Select **Log In**.



Note

If Quality Control tasks are due, the *Select Function to Perform* screen appears. Perform the quality tasks or select **Skip**.

4.2 Functional Tests

4.2.1 Compression Functional Tests

Table 2: Compression Tests

Function	Functional Test
Compression Apply	<p>Press a Compression Apply button:</p> <ul style="list-style-type: none"> • The Compression Paddle moves toward the image receptor. <p>Compression Apply movement stops:</p> <ul style="list-style-type: none"> • When the button is released. • When the inner travel limit is reached.
Compression Release	<p>Press a Compression Release button:</p> <ul style="list-style-type: none"> • The Compression Paddle moves away from the image receptor. <p>Compression Release movement automatically stops:</p> <ul style="list-style-type: none"> • When the button is released. • When the outer travel limit is reached.

4.2.2 C-arm Movement Functional Tests

Table 3: C-arm Tests

Function	Functional Test
C-arm Up	<p>Press a C-arm Up button:</p> <ul style="list-style-type: none"> • The C-arm moves up. <p>C-arm up movement stops:</p> <ul style="list-style-type: none"> • When the button is released. • When the upper travel limit is reached.
C-arm Down	<p>Press a C-arm Down button:</p> <ul style="list-style-type: none"> • The C-arm moves down. <p>C-arm down movement stops:</p> <ul style="list-style-type: none"> • When the button is released. • When the lower travel limit is reached.

4.2.3 Patient Platform Functional Tests

Table 4: Patient Platform Tests

Function	Functional Test
Patient Platform Up	Press a Patient Platform Up button: <ul style="list-style-type: none">The Patient Platform moves up. Patient Platform up movement stops: <ul style="list-style-type: none">When the button is released.When the upper travel limit is reached.
Patient Platform Down	Press a Patient Platform Down button: <ul style="list-style-type: none">The Patient Platform moves down. Patient Platform down movement stops: <ul style="list-style-type: none">When the button is released.When the lower travel limit is reached.
Patient Platform Up Limit	Press the Patient Platform Up Limit button: <ul style="list-style-type: none">The Patient Platform moves up automatically to its upper travel limit. Patient Platform movement stops: <ul style="list-style-type: none">When the upper travel limit is reached.When the Up Limit button is pressed again.When any Patient Platform up/down button is pressed.

4.3 How to Shut Down the System

1. Close any open patient procedures.
2. From the *Select Patient* screen, select the **Log Out** button.
3. From the *Startup* screen, select the **Shutdown** button.
4. Select **Yes** in the confirmation dialog box.

4.3.1 How to Remove All Power from the System

1. Perform the system shutdown procedure.
2. Press the UPS power/reset button to power off the UPS.
3. Turn OFF the Isolation Transformer power switch.
4. Turn OFF the Generator circuit breaker.

Chapter 5 User Interface - Control Monitor

5.1 Select Function to Perform Screen

After login, the *Select Function to Perform* screen appears. This screen shows the quality control tasks that are due.



Note

The *Select Patient* screen appears when no Quality Control tasks are scheduled to be done.

Name	Last Performed	Due Date
QAS	1/6/2016	1/7/2016
Hardcopy Output Quality Test		1/12/2016
Gain Calibration	1/5/2016	1/11/2016
Phantom Image Quality Test	1/5/2016	1/11/2016
Visual Equipment Check		1/12/2016
Compression		1/12/2016
Repeat Analysis		1/12/2016

Number of results: 7

Manager, Tech (Manager) 5:18:29 PM

Figure 14: Select Function to Perform Screen

To Complete a Scheduled Quality Control Task:

1. Select a Quality Control task from the list.
2. Select the **Start** button. Follow the messages to complete the procedure. (The **Start** button is not available for all types of tests.)
- OR -
Select the **Mark Completed** button to mark the status of this procedure as finished.
Select **Yes** to confirm the selected procedure is completed.
3. Select **End QC**.

To Proceed Without Completing All Scheduled Quality Control Tasks:

If all Quality Control tasks are not completed at this time, select the **Skip** button.



Note

If you select the **Skip** button, the *Select Patient* screen appears. See [The Select Patient Screen](#) on page 32 for information about this screen.

If you select the **Admin** button, the *Admin* screen appears. See [The Admin Screen](#) on page 78 for information about this screen.



Note

Quality Control tasks are available to complete at any time. Select the **Admin** button then the **Quality Control** button to access the list of Quality Control tasks.

5.2 How to Change the Language

There are two ways to change the language on the user interface. You can access the language settings through the *Admin* screen or the Taskbar.

Admin Screen

1. In the *Select Function to Perform* screen or the *Select Patient* screen, select the **Admin** button to access the *Admin* screen.
2. In the Operators area, select **My Settings**.
3. From the **Locale** field, select a language from the drop-down menu.
4. Select the **Save** button, then select the **OK** button to the *Update Successful* message. The user interface changes to the selected language.

Taskbar

1. Click in the User Name area.
2. In the pop-up menu, select **My Settings**.
3. In the **User** tab, in the **Locale** field, select a language from the drop-down menu.
4. Select the **Save** button, then select the **OK** button to the *Update Successful* message. The user interface changes to the selected language.

5.3 About the Taskbar

The taskbar at the bottom of the screen shows additional icons, which can be selected to access information or perform system tasks.

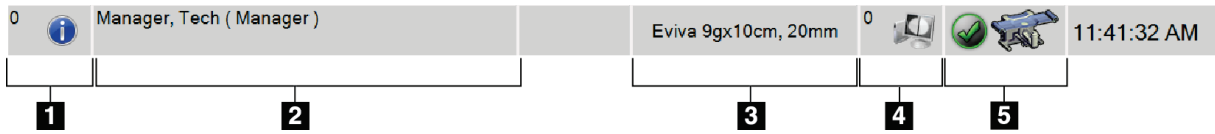





Table 5: Taskbar Menus

	Description	Menu
1 	<p>Information Icon</p> <p>Select the Information icon to display a menu. This section of the taskbar flashes a yellow color when an alarm exists. Select Acknowledge All to stop the flashing indication. Select the Manage Alarms option to display and close any open alarms.</p>	<ul style="list-style-type: none"> No Alarms Acknowledge All Manage Alarms ...
2	<p>Current User Name</p> <p>Select the user name to display a menu. Log Out returns you to the <i>Startup</i> screen. My Settings allows customization of user settings and workflow preferences. Print sends the displayed patient list to a connected printer.</p>	<ul style="list-style-type: none"> Users Menu Log Out My Settings ... Print ...
3	<p>Selected Biopsy Device</p>	
4 	<p>Output Device Icons</p> <p>Select any output device icon to access the <i>Manage Queues</i> screen. This screen shows the status of jobs in the queue, job information for the selected output, and allows you to filter the queue display.</p>	
5 	<p>System Status Icons</p> <p>Select the table icon to display a menu. When the detector and generator are ready for use, a green check mark appears next to the table icon. If the table icon is red with a number next to it, the system needs to wait the listed number of minutes shown before the next set of images can safely be taken.</p> <p>Clear All Faults deletes all fault messages.</p> <p>X-ray Tube, 0 Degrees puts the tubehead at zero degrees of rotation for the next exposure.</p> <p>X-ray Tube, -15 Degrees puts the tubehead at -15 degrees of rotation for a biopsy exposure.</p> <p>X-ray Tube, +15 Degrees puts the tubehead at +15 degrees of rotation for a biopsy exposure.</p> <p>System Diagnostics accesses Subsystem settings.</p> <p>System Defaults opens the <i>System Defaults</i> screen to set the Compression and Generator default values.</p> <p>About displays information about the Acquisition Workstation (refer to The About Screen on page 77).</p>	<ul style="list-style-type: none"> No Alarms Clear All Faults X-Ray Tube, 0 Degrees X-Ray Tube, -15 Degrees X-Ray Tube, +15 Degrees System Diagnostics ... System Defaults ... About ...

5.4 The Select Patient Screen

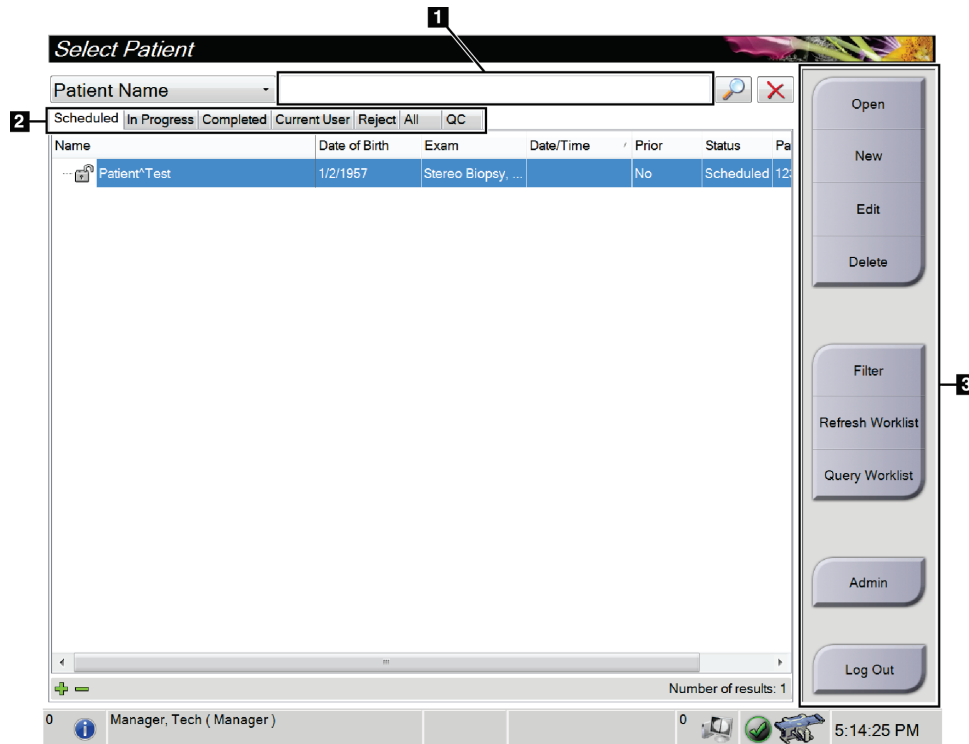

Figure 15: Select Patient Screen

Table 6: The Select Patient Screen

Item	Description
1. Quick Search	Search the local database for the Patient Name, Patient ID, or Accession number.
2. Tabs	<p>The tabs at the top of the screen are configurable. A user with the right permissions can delete tabs and create new tabs.</p> <ul style="list-style-type: none"> • The Scheduled tab shows the scheduled procedures. • The In Progress tab shows the procedures not complete. • The Completed tab shows the completed procedures. • The Current User tab shows the procedures for the current Operator. • The Reject tab shows the procedures with rejected views. • The All tab shows all procedures for all users. • The QC tab shows the Quality Control procedures.

Table 6: The Select Patient Screen

Item	Description
3. Buttons	<p>Many functions are accessed from this screen by selecting a particular button:</p> <ul style="list-style-type: none"> • Open: Open a selected patient. • New: Add a new patient—see How to Add a New Patient on page 34. • Edit: Edit the patient information—see How to Edit the Patient Information on page 34. • Delete: Delete a patient from the worklist—see How to Delete a Patient Manually on page 34. • Filter: Use a Patient Filter—see The Patient Filter Screen on page 35. • Refresh Worklist: Update the Scheduled Patient Worklist information—see How to Refresh the Worklist on page 36. • Query Worklist: Search for a patient in the Modality Worklist—see How to Query the Worklist on page 36. • Admin: Access the Admin Screen—see The Select Patient Screen on page 32. • Log Out: Exit the system.

5.4.1 How to Open a Patient

1. Select a tab to display the desired list of patients.
2. Select a patient from the list. The **Open** button becomes active.
3. Select the **Open** button to display the *Procedure* screen for that patient.

5.4.2 How to Add a New Patient

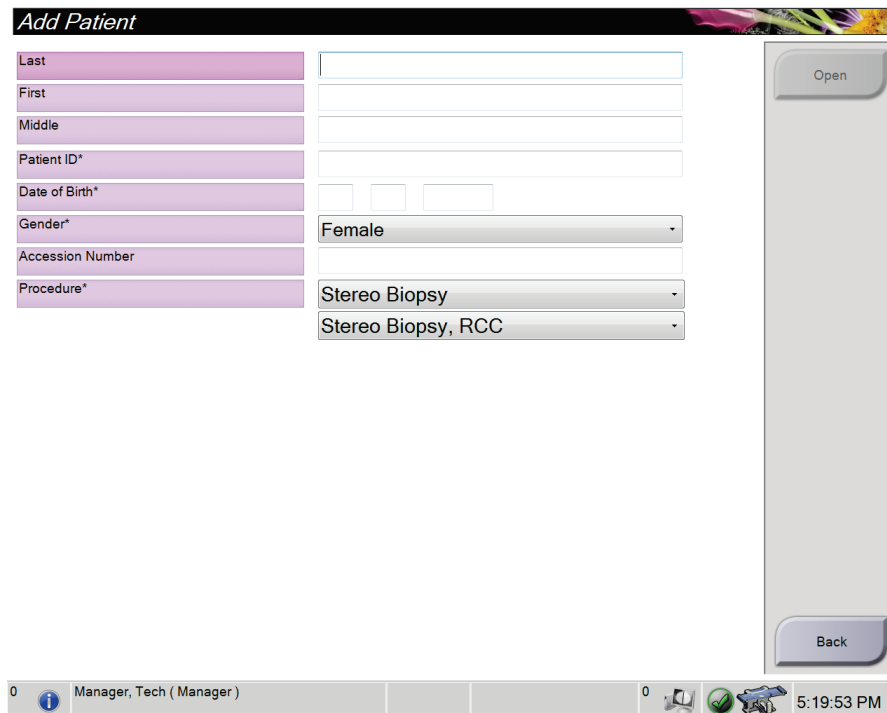

Figure 16: Add Patient Screen

1. In the *Select Patient* screen, select the **New** button. The *Add Patient* screen appears.
2. Enter the new patient information and select a procedure.
3. Select the **Open** button. The *Procedure* screen for the new patient appears.

5.4.3 How to Edit the Patient Information

1. In the *Select Patient* screen, select the patient name then select the **Edit** button.
2. In the *Edit Patient* screen, make changes then select the **Save** button.
3. When the *Update Successful* dialog box appears, select the **OK** button.

5.4.4 How to Delete a Patient Manually

1. In the *Select Patient* screen, select one or more patients.
2. Select the **Delete** button.
3. When the confirmation dialog box appears, select **Yes**.



Note

The Technologists do not have permissions to delete patients.

5.4.5 The Patient Filter Screen

After selecting the **Filter** button in the *Select Patient* screen, the *Patient Filter* screen for the selected tab appears.

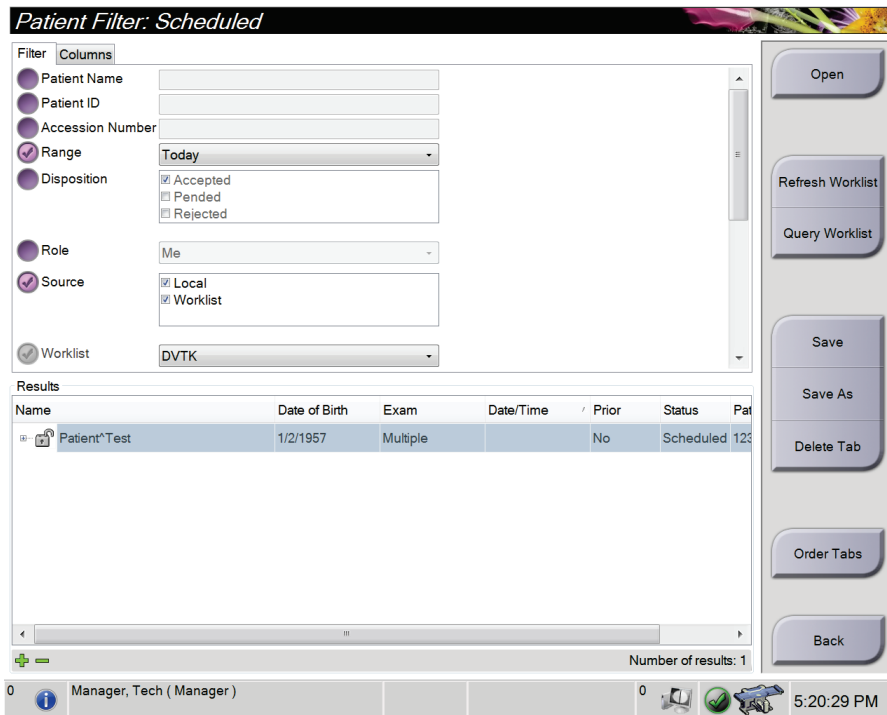

Figure 17: Filter Tab in the Patient Filter Screen

The Filter and Columns Tabs in the Patient Filter Screen

Use the **Filter** tab to change the filter options for the patient list. When you select or cancel an option, the change shows in the Results area of the screen.



Note

You must have Manager level access to save these new filters to the selected tab in the *Select Patient* screen. (See [Other Functions of the Filter Tab](#) on page 36.)

Use the **Columns** tab to add more search options (for example, Age, Gender, Notices) to the filtered list. The options show as columns in the results area. To add more columns to a filtered list, select the **Columns** tab then select the options.



Note

When you select a line in the results list then select the **Open** button, the *Procedure* screen for the selected patient appears.

Other Functions of the Filter Tab

The **Filter** tab allows users with access privileges to add, change, or delete tabs in the *Select Patient* screen. Refer to the following table.

Table 7: The Filter Tab Options (Require Access Privileges)

<p>Change the current patient filter parameters.</p>	<ol style="list-style-type: none"> 1. Select a tab on the <i>Select Patient</i> screen. 2. Select the Filter button. 3. Select the filter options. 4. Select the Save button. 5. Make sure the name of the tab you selected is in the name box. 6. Select OK.
<p>Create a new tab for the <i>Select Patient</i> screen.</p>	<ol style="list-style-type: none"> 1. Select a tab on the <i>Select Patient</i> screen. 2. Select the Filter button. 3. Select the filter options for the tab. 4. Select the Save As button. 5. Enter a new name for the tab. 6. Select OK.
<p>Delete a tab from the <i>Select Patient</i> screen.</p>	<ol style="list-style-type: none"> 1. Select a tab on the <i>Select Patient</i> screen. 2. Select the Filter button. 3. Select the Delete button. 4. Select Yes in the confirmation dialog box.

5.4.6 How to Refresh the Worklist

Select the **Refresh Worklist** button to update the Scheduled patient lists.

5.4.7 How to Query the Worklist

Select the **Query Worklist** button to search for a patient or a list of patients.

Use one or more fields to query the Modality Worklist Provider. All fields to query are configurable. The default fields are as follows: Patient name, Patient ID, Accession Number, Requested Procedure ID, Scheduled Procedure Date. The scheduled procedure shows, and the patient is added to the local database.

5.4.8 About the Admin Button

See [System Administration Interface](#) on page 77.

5.5 The Procedure Screen

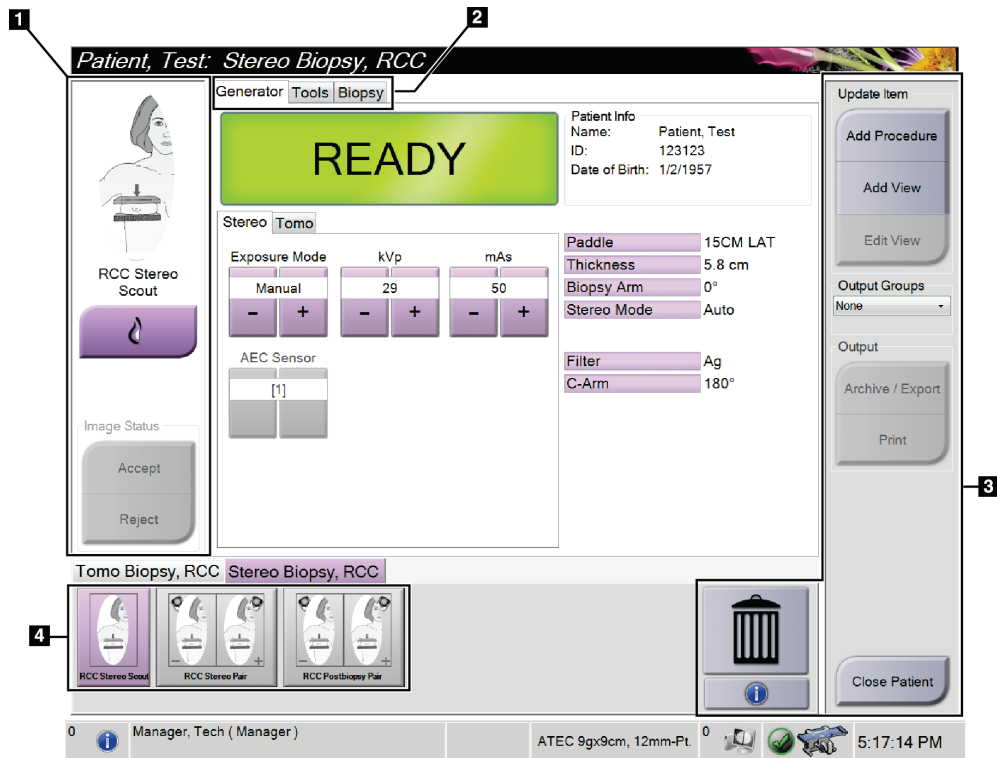

Figure 18: Procedure Screen

Table 8: The Procedure Screen

Item	Description
1. Image Status	The view icon shows the current selected view. Implant Present button—select when the patient has an implant. Accept button—select to accept the image. Reject button—select to reject the image.
2. Tabs	Select the Generator tab to adjust the exposure techniques for the procedure. Select the Tools tab to review the images—refer to The Image Review Tools Tab on page 59. Select the Biopsy tab to create targets—refer to Biopsy Tab on page 65.
3. Buttons	Many functions are accessed from this screen by selecting a particular button: Add Procedure: Add a new patient—refer to How to Add a New Patient on page 34. Add View: Add a new view—refer to How to Add or Remove a View on page 39. Edit View: Assign a different view to an image—refer to How to Edit a View on page 40. Archive/Export: Send images to an output—refer to How to Use the On-Demand Outputs on page 44. Print: Print—refer to How to Print on page 46. Close Patient: Exit the patient and procedure. Trash Can: Delete a view.
4. Image Thumbnails	Select a tab to show the thumbnail views/images for that procedure.

5.5.1 How to Use the Implant Present Button

The **Implant Present** button is above the **Accept** button on the *Procedure* screen. This button applies special implant processing to the implant and implant displaced views, and changes the "Implant Present" DICOM tag in the image header. When this button is selected, a check mark appears on the button.



Select the **Implant Present** button for both implant and implant displaced views before you acquire the image.



Note

The **Implant Present** button is automatically selected if any procedure tabs contain an ID view.

5.5.2 How to Add a Procedure

1. To add another procedure, select the **Add Procedure** button on the *Procedure* screen to access the *Add Procedure* dialog box.

A dialog box titled "Add Procedure" with a decorative header. It contains two drop-down menus under the "Procedure" section, with "Stereo Biopsy" and "Stereo Biopsy, RCC" selected. Below is a "Procedure Info" section with a checked "Inherit Accession Number" checkbox and an "Accession Number" input field. At the bottom right are "OK" and "Cancel" buttons.

Figure 19: Add Procedure Dialog Box

2. Use the drop-down menus to select the type of procedure to add.
3. Type an Accession Number or select the Inherit Accession Number check box to use the current number.
4. Select the **OK** button. A new tab is added with the thumbnail images for the procedure that was selected.

5.5.3 How to Add or Remove a View

To Add a View:

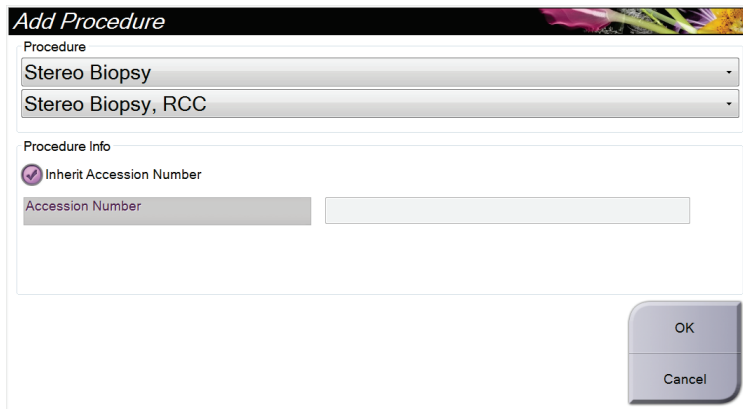
1. Select the **Add View** button to access the *Add View* screen.



Note

Depending on the license settings for your system, you may see different tabs.

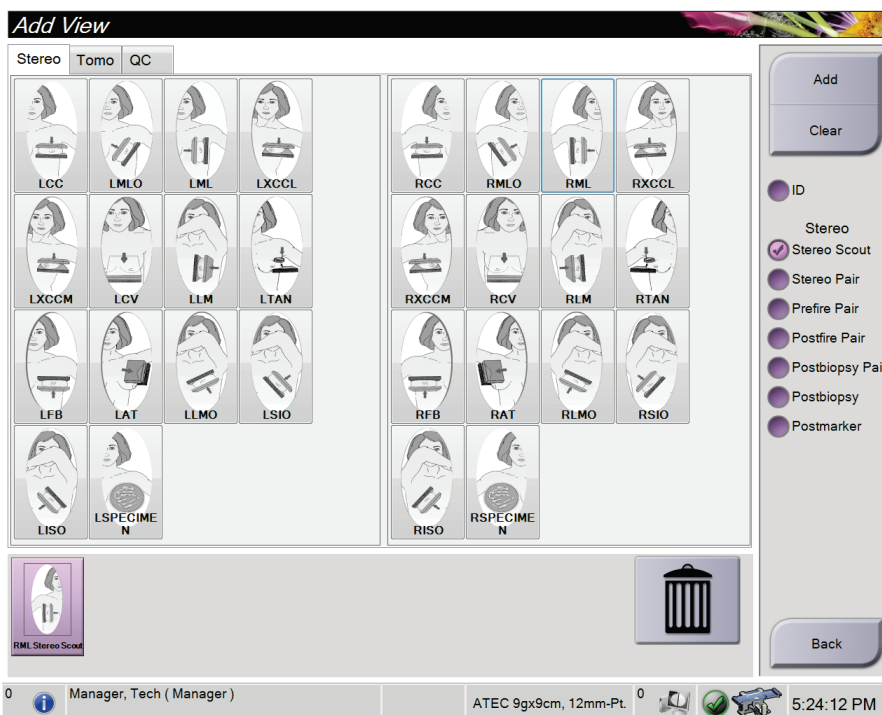

Figure 20: Add View Screen

2. Select the tab, select the view, and select a View Modifier from the right panel of the screen.
3. Select the **Add** button. A thumbnail image of each selected view appears in the bottom panel of the screen.

To Remove a View:

- To remove a single view from the added list: in the bottom panel of the screen, select the view thumbnail then select the **Trash Can** icon.
- To remove all views from the added list: select the **Clear** button.

5.5.4 How to Edit a View

Use the *Edit View* screen to assign a different view to an image.

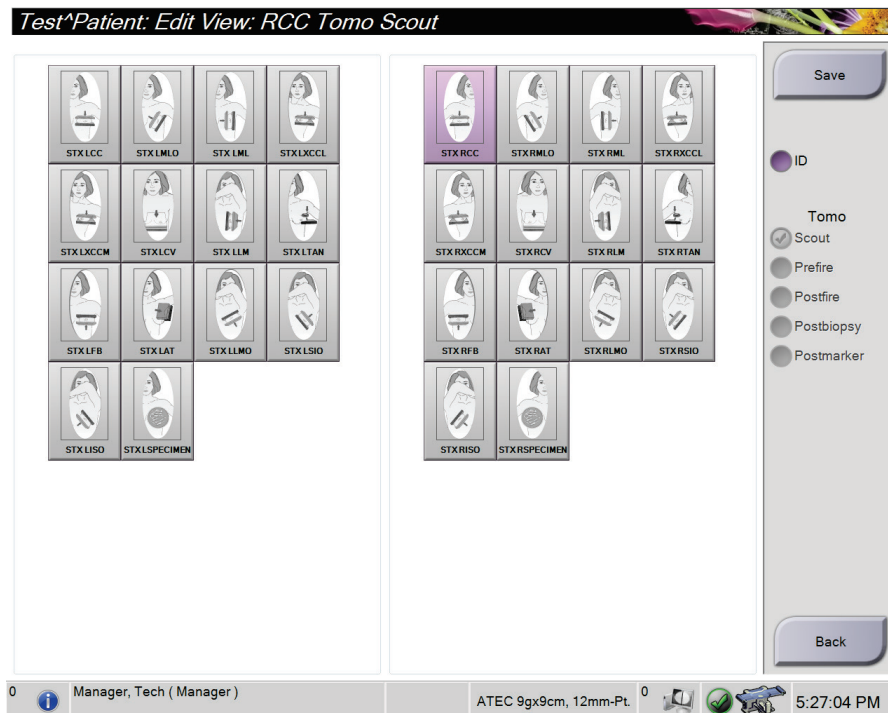

Figure 21: Edit View Screen

To Edit a View:

1. In the *Procedure* screen, select an exposed thumbnail image view.
2. Select the **Edit View** button to access the *Edit View* screen.
3. Select the view then select a View Modifier.
4. Select the **Save** button.
5. When the *Update Successful* dialog box appears, select the **OK** button.

5.5.5 Procedure Information Dialog Box

To show procedure information, select the **Procedure Information** button located beneath the **Delete View** (trash can) button. The Procedure Info window displays with the following information:

- Procedure Name
- Accession Number
- Procedure Status
- Procedure Start and End Date and Time
- Dose Information (per Breast and Cumulative)

For Procedures that contain no exposed views, select the **Delete Procedure** button in the Procedure Information window to remove the selected procedure from the patient.

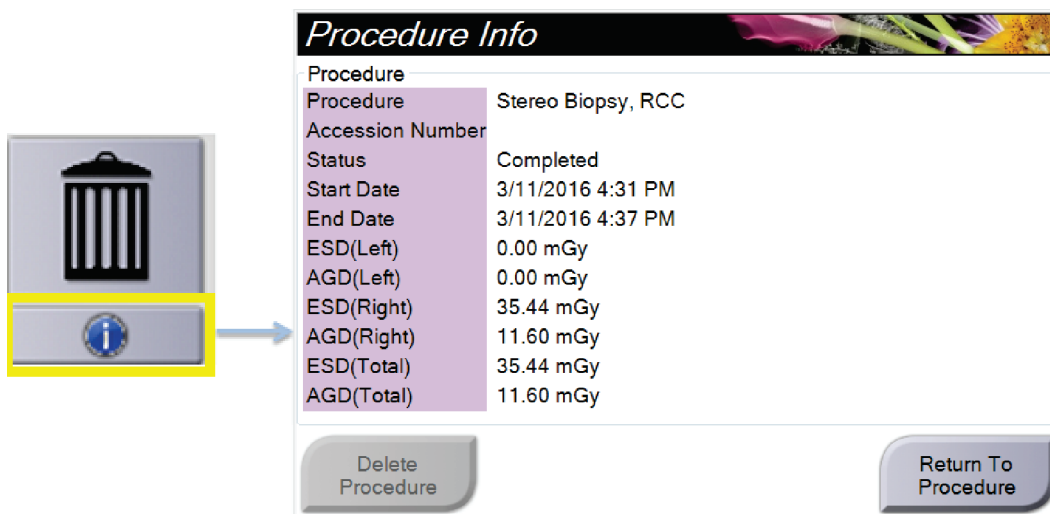

Figure 22: The Procedure Info Window

5.5.6 How to Close a Procedure

Select the **Close Patient** button. If images were acquired, a *Close Procedure* dialog box appears. Select one of the following options:

Close Procedure Complete	Closes the procedure and puts the procedure in the Complete tab.
Close Procedure In Progress	Closes the procedure and puts the procedure in the In Progress tab.
Close Procedure Discontinue	Closes the procedure and puts the procedure in the Discontinued tab. A dialog box appears and you must select the reason the procedure was discontinued from the list or add a new reason.
Return To Procedure	Returns to the procedure.

5.6 How to Use the Output Groups

The accepted images are sent automatically to the output devices in the selected Output Group. The system configuration controls if the images are sent after a patient is closed or after the image is accepted.



Note

Tomosynthesis images are not sent to a print device in the selected Output Group. You can print tomosynthesis images from the *Print* screen.

5.6.1 How to Select an Output Group

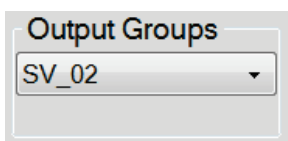

Figure 23: Output Groups Field

Select an output device group like PACS, Diagnostic Workstations, CAD devices and printers from the Output Groups drop-down menu in the Procedure screen.



Note

Images are not sent if an Output Group is not selected.

5.6.2 How to Add or Edit an Output Group



Note

The configuration of Output Groups occurs during installation, but you can edit existing groups or add new groups.

To Add a New Output Group:

1. Access the *Admin* screen.
2. Select the **Manage Output Groups** button.
3. Select the **New** button, enter the information, then select the output device(s).
4. Select the **Add** button.
5. When the *Update Successful* message appears, select **OK**.
6. You can select any group to set as the default.

To Edit an Output Group:

1. Access the *Admin* screen.
2. Select the **Manage Output Groups** button.
3. Select the **Edit** button, then make the changes.
4. Select the **Save** button.
5. When the *Update Successful* message appears, select **OK**.

5.6.3 How to Use the Custom Output

The Custom Output option lets you make an output group from the *Procedure* screen. The custom group that you make stays as the Custom option until another custom group is made.

To Make a Custom Group from the *Procedure* screen:

1. In the *Procedure* screen, select **Custom** from the Output Groups drop-down menu.
2. In the *Output Group* screen, select from the list of available devices, then select **OK**.

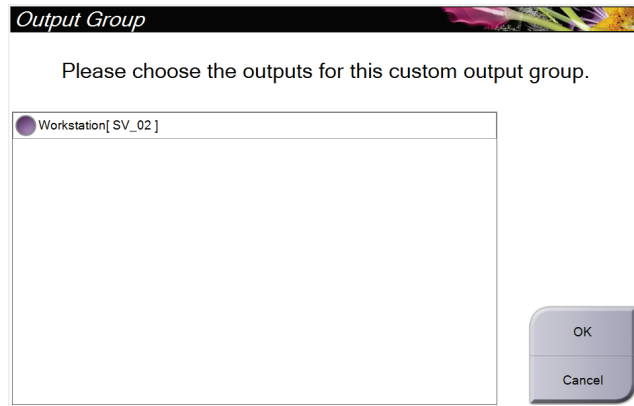

Figure 24: An Example Custom Output Group

5.7 How to Use the On-Demand Outputs

The On-Demand Outputs are: **Archive/Export** or **Print**. You can manually Archive, Export, or Print the currently opened patient until the procedure is closed.

When you select an **On-Demand Output** button, you have the option to send images from the patient that is open to any of the configured output devices.

5.7.1 How to Archive

1. Select the **Archive/Export** button.
2. Select the procedure or views in the *On Demand Archive* screen:
 - **Select All** button selects all items that show in this screen.
 - **Clear** button deselects items that are selected in this screen.
 - **Priors** button shows previous procedures and views for this patient.
 - **Rejected** button shows rejected views for this patient.
3. Select a storage device:
 - Select the **Device List** button and make your selection from the options in the *Storage Device* drop-down menu.

OR

 - Select an output group from the *Output Group* drop-down menu.
4. Select the **Archive** button to copy the selected images to the selected archive.



Note

Use the Manage Queue utility in the taskbar to review the archive status.

5.7.2 How to Export

1. Select the **Archive/Export** button (on the right side of the *Procedure* screen).
2. Select the images to export, then select the **Export** button.

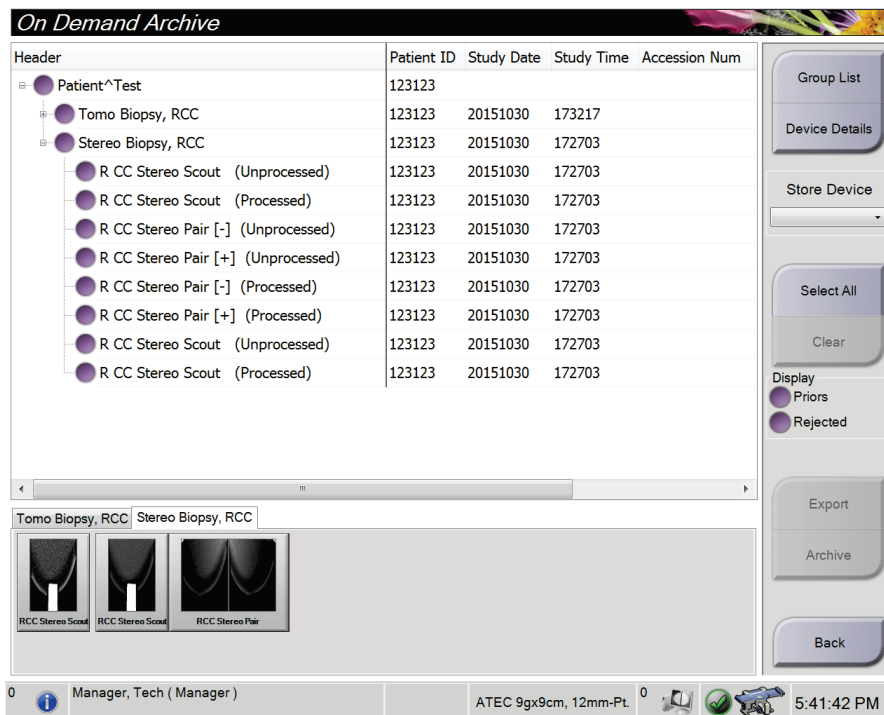
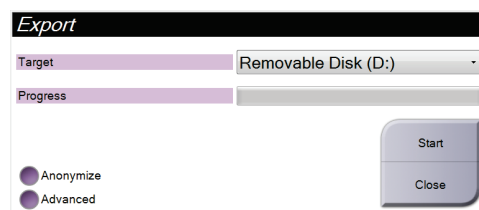

Figure 25: On Demand Archive Screen

3. In the *Export* screen, select the Target from the drop-down list of media devices.



- To anonymize patient data, select **Anonymize**.
 - To select a folder on your local systems for storage of your selections and to select the Export types, select **Advanced**.
4. Select the **Start** button to copy the selected images to the selected device.

5.7.3 How to Print

1. From the *Procedure* screen, select the **Print** button to show the *Print* screen. See the figure [The Print Screen](#) on page 47 to prepare your print data.
2. Select the film format from the film format area of the screen (item 11).
3. Select a thumbnail image.
4. Select the image mode: Conventional, Projection, or Reconstruction (item 8).
5. Select the Film Print Preview area (item 16) in the *Print* screen. The image that shows in this area is the image that prints on the film.
6. To put other images on the same multi-format film, repeat steps 3 through 5.
7. To print a different film format of the same images, select the **New Film** button (item 12), then complete steps 2 through 6.
8. Use the buttons in the top left area of the *Print* screen (items 1-6) to hide or show patient data, markings and annotations, and to change the orientation of the image.
9. Select the **Print** button to print your films.

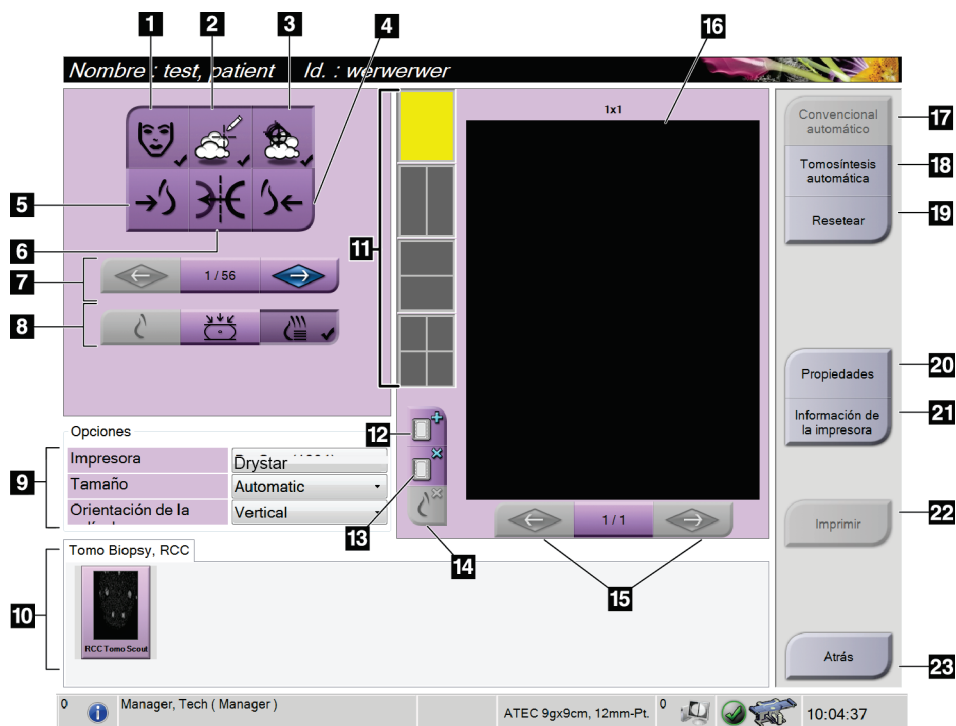

Figure 26: Print Screen

Figure Legend

- | | |
|---|---|
| 1. Show or hide patient data. | 13. Delete a film. |
| 2. Show or hide markings and annotations. | 14. Delete an image from a film. |
| 3. Show or hide targets in images from a biopsy. | 15. Step through the film pages. |
| 4. Print the image from a dorsal perspective. | 16. Film print preview area. |
| 5. Print the image from a ventral perspective. | 17. Print Conventional with the default setup. |
| 6. Reverse (mirror) the image. | 18. Print tomosynthesis images (slices or projections) Tagged for Print (Tomosynthesis option). |
| 7. Go to the previous or next tomosynthesis slice or projection (Tomosynthesis option). | 19. Return the <i>Print</i> screen to default settings. |
| 8. Select Conventional, Projection, or Reconstruction views (Tomosynthesis option). | 20. Open the <i>Properties</i> screen. |
| 9. Select the printer options. | 21. Show the printer IP address, AE Title, Port, and capability for True Size print. |
| 10. View thumbnail images. | 22. Start the print process. |
| 11. Select the film format (number of tiles). | 23. Return to the <i>Procedure</i> screen. |
| 12. Create a new film. | |

Chapter 6 User Interface - Biopsy Control Module

6.1 Biopsy Control Module Display

6.1.1 Home Screen

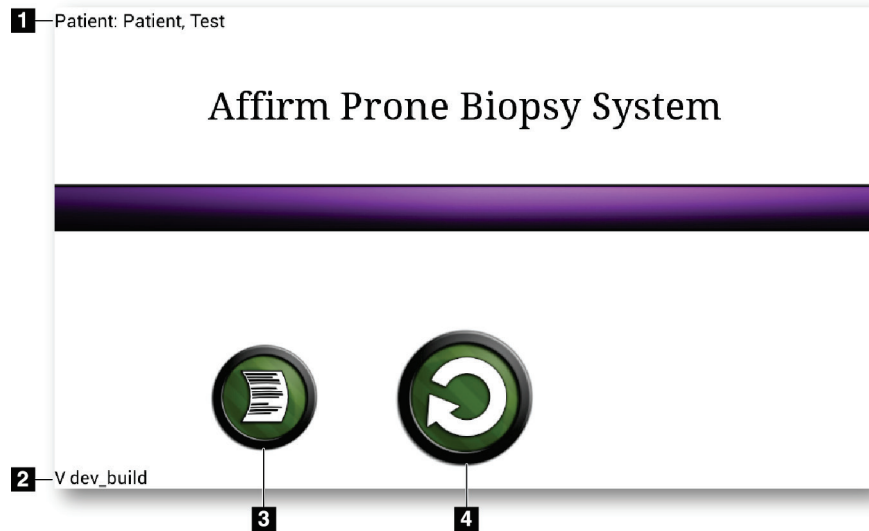

Figure 27: Home Screen

Figure Legend

1. Patient Name
2. Biopsy Control Module Version Number
3. Go to Log Viewer
4. Go to Target Guidance

6.1.2 Target Guidance Screen

The *Target Guidance* screen is the main screen for the biopsy control module. This screen shows the current position of the biopsy device, the selected target coordinates, and the Cartesian difference between the two positions. The screen also shows the safety margins, the system status, and the biopsy device installed on the system. The left side of the display has a 3-D depiction of the current system state.

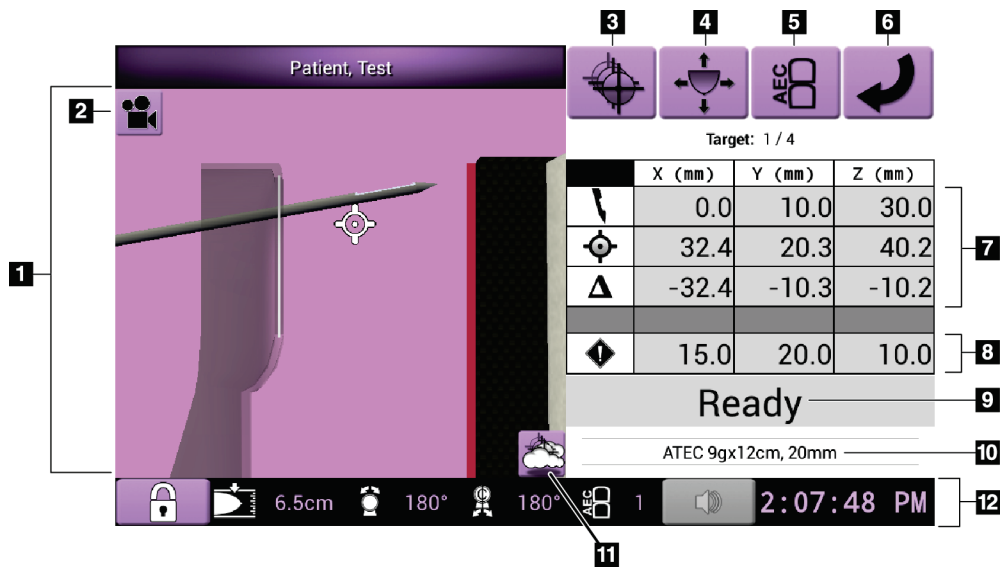

Figure 28: Target Guidance Screen

Figure Legend

1. 3-D Navigation Viewer
2. Change View button
3. Go to the *Select Target* screen
4. Go to the *Jog Mode* screen
5. Go to the *AEC Adjust* screen
6. Go to the previous screen
7. Target information
8. Safety margins
9. System status
10. Selected biopsy device
11. Show or hide target points
12. Taskbar info

Colored Cells in the Screens

Green Cells

When all Differential cells are **Green**, the biopsy device is in the correct position for the selected target. When the biopsy device is fired, the target is at the center of the aperture of the device.

Yellow Cells

Yellow indicates that the biopsy device is in the correct position for that axis, but you must move the device to the final Z-position. When the biopsy device is in the final Z-position, the yellow cell changes to green.

Red Cells

Red indicates a problem with a safety margin. The **Sound** button turns red and the system makes repeated beeps. Make adjustments in the axis indicated by red. When the cell is not red, the device is within the safety limits.

The Sound Button

- When a safety margin is violated, the **Sound** button changes to red and the system repeats a beep sound.
- To stop the sound, press the **Sound** button. All system beep sounds are muted, and the icon on the button changes.
- When you correct the safety margin violation, the button changes back to normal.
- If you press the button and do not correct the system fault within two minutes, the system beep sounds are enabled automatically.

Select Target Screen

The *Select Target* screen allows the user to select a different target for biopsy guidance or to move to one of the home positions.

To move the biopsy device to one of the targets shown in this screen:

1. Select one of the **Target Coordinates** buttons.
2. Press the **Previous Screen** button to go to the *Target Guidance* screen.
3. Press and hold a **Motor Enable** button pair on one of the Biopsy Control Module cover extensions.



Note

You must simultaneously press both buttons of a **Motor Enable** button pair to start the motor movement.

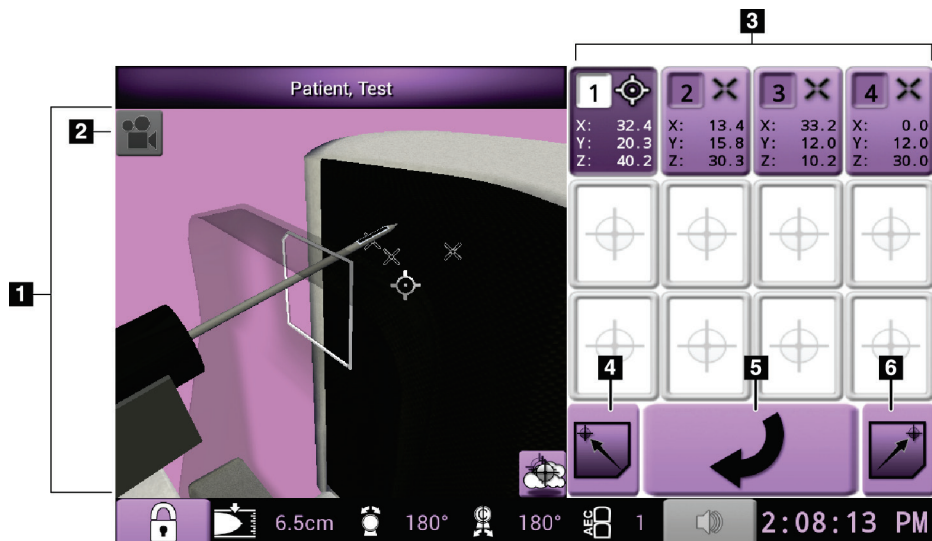

Figure 29: Select Target Screen

Figure Legend

1. 3-D Navigation Viewer
2. Change View button
3. Target coordinates
4. Go to the Home Left position
5. Go to the previous screen
6. Go to the Home Right position

Jog Mode Screen

The *Jog Mode* screen allows the user to manually overwrite the targeting coordinates of the Biopsy Control Module. The arrow buttons in the *Jog Mode* screen change the Jog value of each of the coordinates.

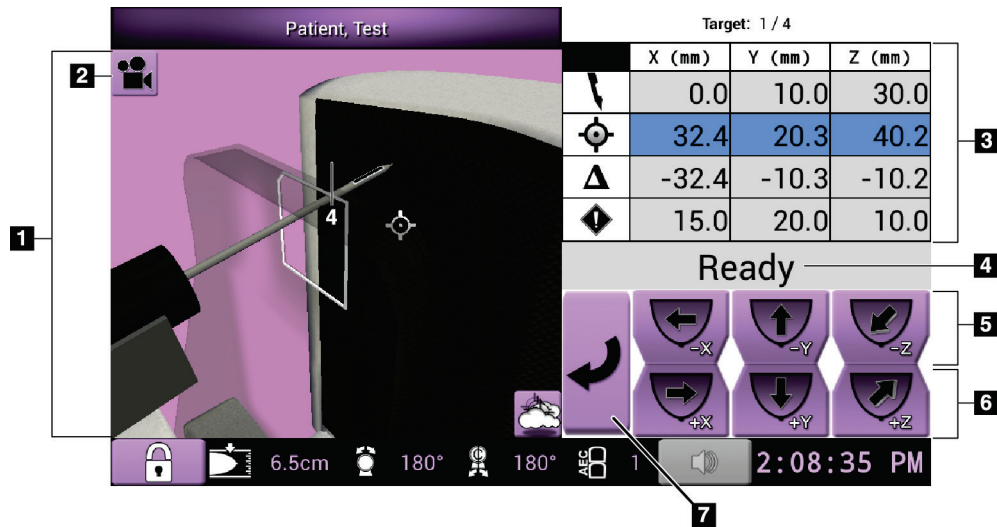

Figure 30: Jog Mode Screen

Figure Legend

1. 3-D Navigation Viewer
2. Change View button
3. Target information
4. System status
5. Change X, Y, and Z-axis Jog values in negative direction
6. Change X, Y, and Z-axis Jog values in positive direction
7. Go to the previous screen

AEC Adjust Screen

The *AEC Adjust* screen allows the user to select the AEC Sensor positions. The AEC Sensor has five manual positions and an automatic position.

Use the plus (+) and minus (-) buttons on the screen to change the sensor position. Auto AEC allows the system to calculate the best exposure for the breast.

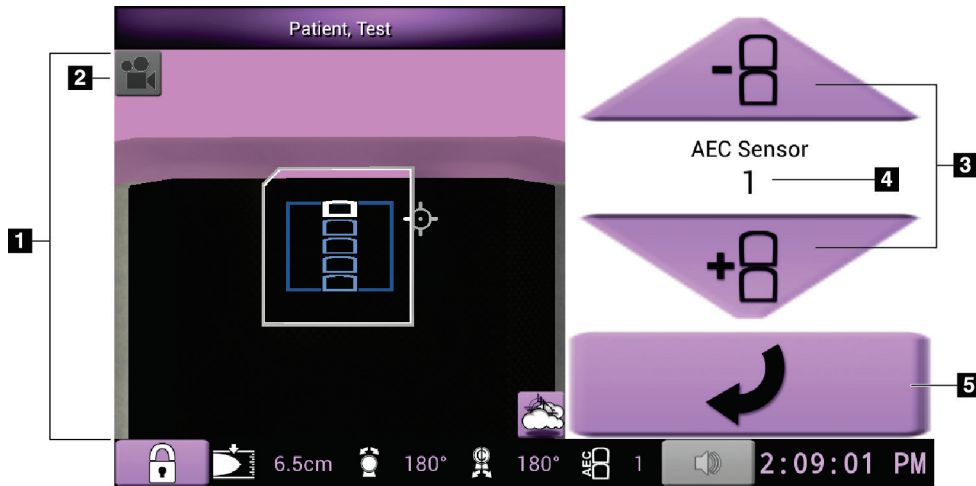

Figure 31: AEC Adjust Screen

Figure Legend

1. 3-D Navigation Viewer
2. Change View button
3. AEC position adjust buttons
4. AEC Sensor position
5. Go to the previous screen

Chapter 7 Images

7.1 Introduction

After you make an exposure, the acquired image displays on the Image Display monitor.

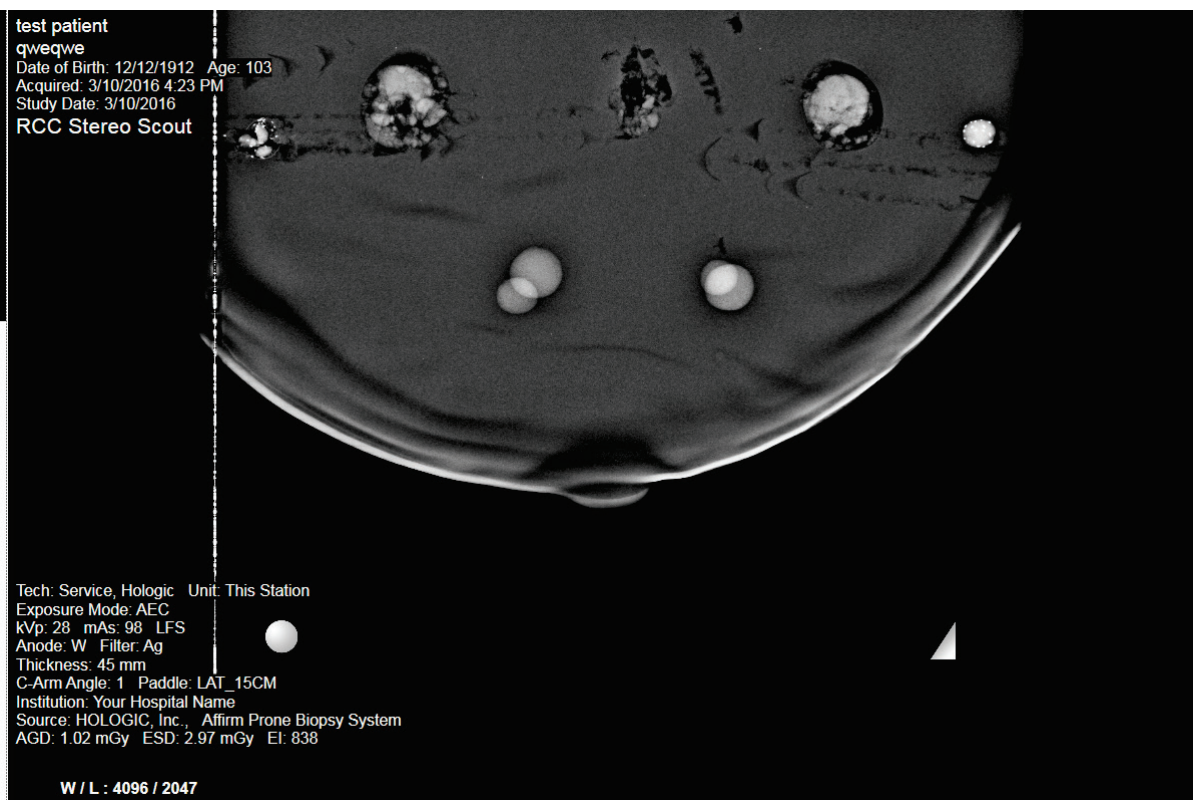

Figure 32: Image Display Screen

Patient and procedure information can be displayed on the *Image Display* screen. The top corner of the image shows patient information and the exam date. The bottom corner of the image shows procedure information including: exposure mode, patient dose, compression thickness, C-arm angle, and facility and technologist information. To turn the information on or off, go to the **Tools** tab and select the **Patient Information** button.

7.1.1 Conventional Imaging Sequence of Events

- Review the image after the exposure and add a comment, if necessary.
- Accept or Reject the image. A thumbnail image appears in the Case Study area of the screen.



Note

A manager user can configure the system to Auto-Accept new images.

- If you select the **Reject** button, an "X" appears on the thumbnail image.

7.1.2 Tomosynthesis Imaging Sequence of Events

- Wait for the image reconstruction to complete.
- Accept or Reject the images.



Note

A manager user can configure the system to Auto-Accept new images.

7.2 How to Acquire an Image

Refer to [Sample Clinical Sequences](#) on page 95 for information about clinical procedures.

1. On the Control Handle, press the **System Lock** button to lock the C-arm. (The system does not allow x-rays unless the **System Lock** button is on.)
2. At the Acquisition Workstation, select a view from the thumbnail images at the bottom of the screen.
3. Press and hold the **X-ray** button for the full exposure.

During the exposure:

- A System Message with the x-ray indicator and a yellow background shows (see the following figure).
- An audible tone sounds:

Scout – X-Ray tone is on continuously during the exposure.

Biopsy – X-Ray tone is on only during the exposure at -15 and then again at +15 degrees. The X-Ray tone is not on while the Tube Arm is moving from the -15 to +15 degree positions.

Tomo – X-Ray tone is pulsed along with the exposures – 30 individual X-Ray beeps are heard during the Tomo exposure sequence.

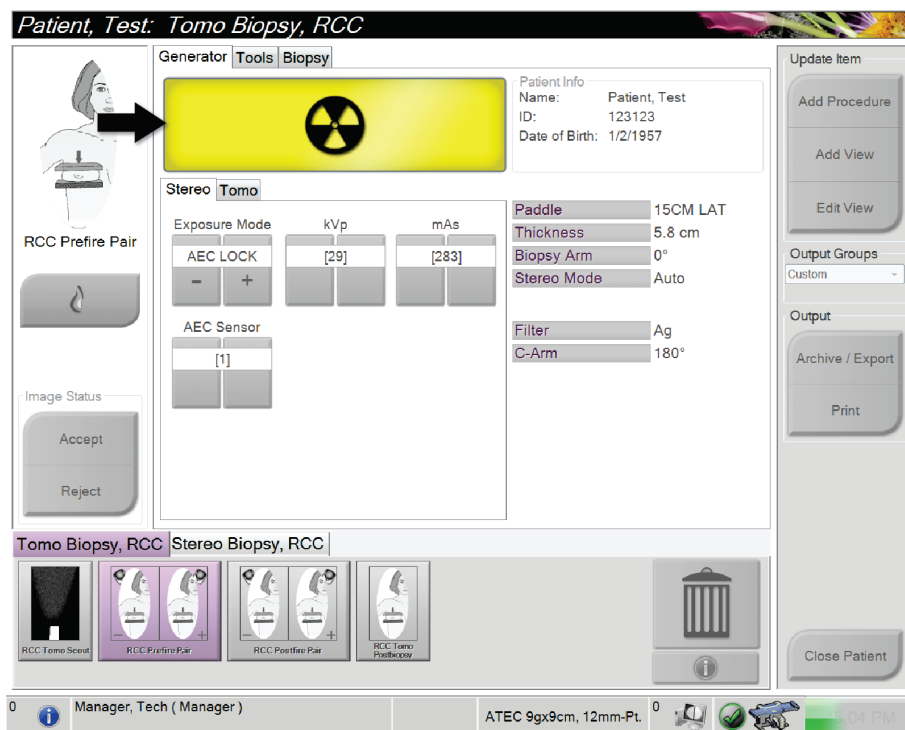

Figure 33: Exposure in Progress

- When the tone stops and the System Message shows **Standby** (see the following figure), release the **x-ray** button.

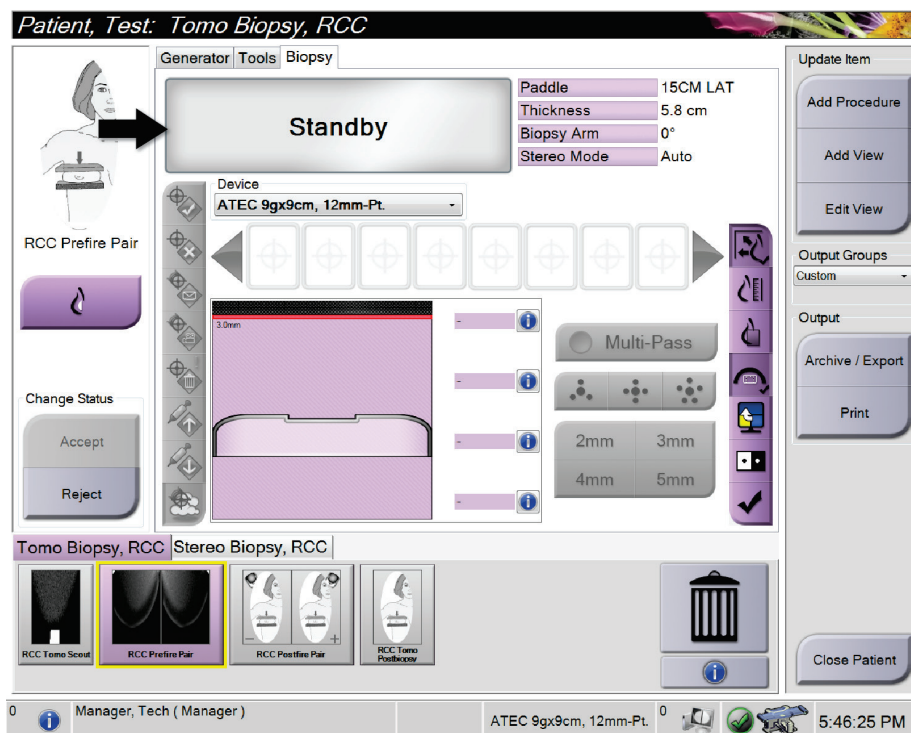

Figure 34: Exposure Complete

- The image appears on the Image Display monitor when the x-ray is finished.
Select one of the following options to complete the acquisition:
 - Accept** the image. The image transmits to output devices with all attributes and marks. (If Auto-Accept is selected, the **Accept** button is disabled.)
 - Reject** the image. When the dialog box appears, select the cause for the reject. The Image Display monitor clears. You can repeat the rejected view, or select another view.



Note

A manager user can configure the system to Auto-Accept new images. Auto-Accept disables the **Accept** button.

7.3 How to Review the Images

Review of images involves use of the thumbnails, image review tools, and display modes.

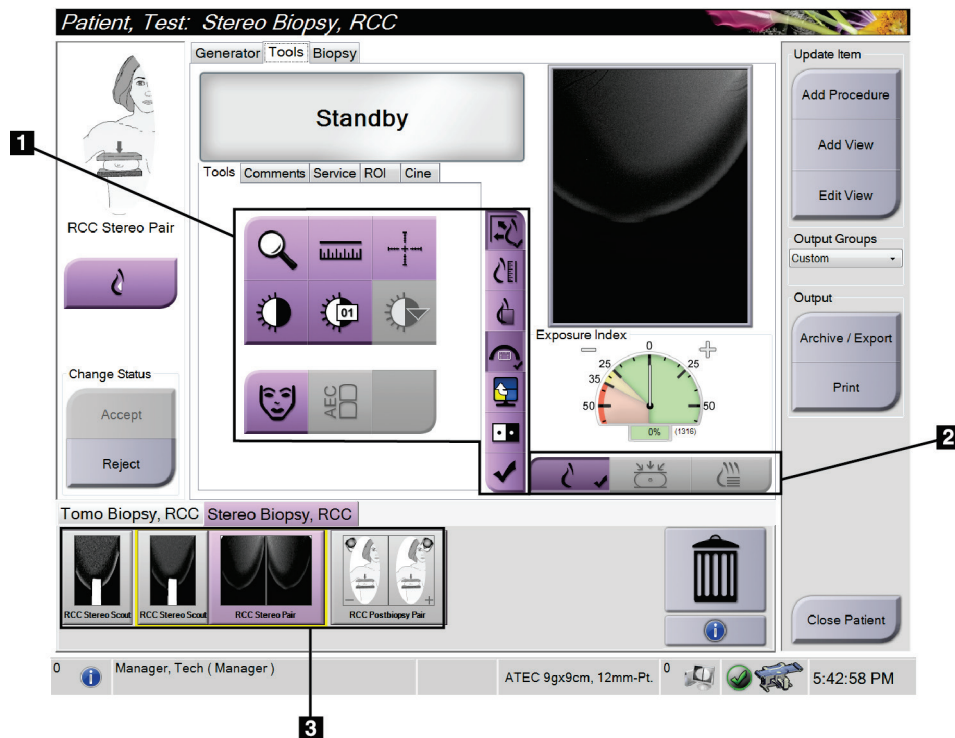

Figure 35: Tools Tab

Figure Legend

- Image Review Tools - refer to [The Image Review Tools Tab](#) on page 59.
- Image Display Modes - refer to [Display Modes \(Tomosynthesis option\)](#) on page 60.
- Thumbnail Views/Images
 - Select any thumbnail image to display that image on the Image Display monitor. The thumbnail image is marked accordingly if the image is rejected.

7.3.1 The Image Review Tools Tab

The **Tools** tab in the *Procedure* screen provides the image review tools. A check mark appears on an active tool.

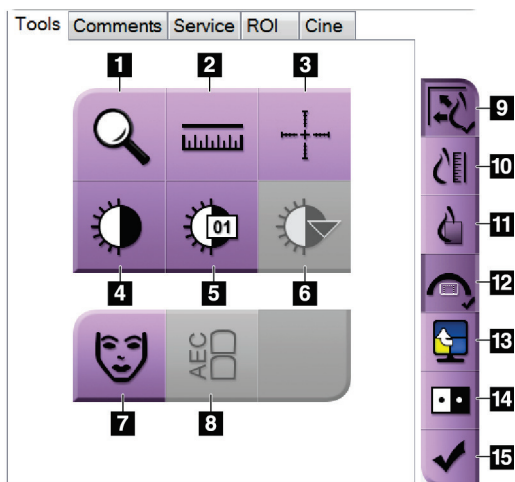

Figure 36: Image Review Tools

Figure Legend

1. The **Zoom** tool magnifies a section of the image.
2. The **Ruler** tool measures the distance between two points.
3. The **Crosshair** tool displays a crosshair on the Image Display monitor.
4. The **Window/Level** tool changes the brightness and contrast.
5. The **Window/Level Fine Adjustment** tool allows the entry of specific window and level values.
6. The **LUT Selection** tool scrolls through available Window/Level settings for a displayed image with LUTs attached.
7. The **Patient Information** button activates the patient information display.
8. The **AEC** button displays the AEC Sensor areas used for the exposure calculation. The sensor areas display on the Image Display monitor.
9. The **Fit-to-Viewport** button fits the image within the image tile.
10. The **True Size** button displays the image in the actual size of the breast.
11. The **View Actual Pixels** button displays the image in full resolution.
12. The **Biopsy View Overlay** button displays the allowable target area.
13. The **Image Tile Advance** button sets the active tile.
14. The **Invert Image** tool changes blacks to whites and whites to black.
15. The **Tag for Print** button tags the projection or reconstruction images of a tomosynthesis image to print later (Tomosynthesis option).

7.3.2 Other Image Review Tools

The Other Tabs

- **Comments:** Add comments.
- **Service:** Mark an image for service use.
- **ROI:** Draw a Region of Interest on the image display monitor.
- **Cine:** Show a series of images as a movie (Tomosynthesis option).

The Exposure Index

The Exposure Index is an image quality guide. When the Exposure Index indicates the red or yellow area, review the selected image for noise and make a decision about a retake.

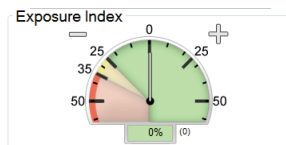

Figure 37: Exposure Index

Display Modes (Tomosynthesis option)

Use the Conventional, Projections, and Reconstruction buttons to select the type of view to display on the Image Display monitor. You can change between conventional, projections, and reconstruction to display the combination images.

- Use Conventional to display conventional images.
- Use Projections to display the projections.
- Use the Reconstruction to display the reconstructed slices.

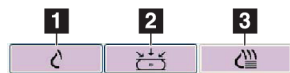

Figure 38: Display Modes

Figure Legend

1. Conventional button
2. Projections button
3. Reconstruction button

7.3.3 Slice Indicator

The Slice Indicator shows only on tomographic reconstructions.

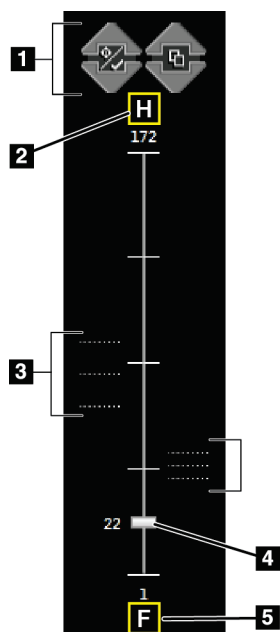

Figure 39: Slice Indicator

Figure Legend

1. Up and Down arrows let you change between slices that contain a lesion target and slices that are tagged for printing.
2. "H" (anatomical reference to head direction)
3. Slices that contain targets or are tagged for printing.
4. Scroll bar moves through the slices of the reconstruction.
5. "F" (anatomical reference to foot direction)

7.3.4 How to Correct and Reprocess Implant Images

You must correct the image if you acquire an implant or an implant displaced view without the **Implant Present** button activated.

If the Image Is Not Accepted

Select the **Implant Present** button on the *Procedure* screen to indicate an implant exists. A check mark appears on the button and the image reprocesses.



If the Image Is Accepted

1. Select the image.
2. Select the **Implant Present** button on the *Procedure* screen to correct the image. A check mark appears on the button and the image reprocesses.
3. Select the **Accept** button to accept the changes.



Note

The corrected image is sent automatically to the selected output devices if the system is set to send images when the **Accept** button is selected.

Chapter 8 Biopsy

8.1 Biopsy Approach

The system has the capability to do biopsies from a standard needle approach or a lateral needle approach. When a standard approach is not optimal, the lateral approach allows the needle to enter the breast parallel to the breast platform and perpendicular to the Compression arm. Lateral approach is useful when the thickness of the breast or the location of the lesion makes the standard approach impractical.

To make both approaches possible, the C-arm and Biopsy Arm are each capable of a wide angle of movement. The C-arm has a full 180° range of motion and can be positioned at any angle throughout the range of motion. The Biopsy Arm also moves 180° with three detent positions relative to the C-arm. The detent positions are 0°, +90°, and -90° with counterclockwise (from the prone patient point of view) being the positive direction.

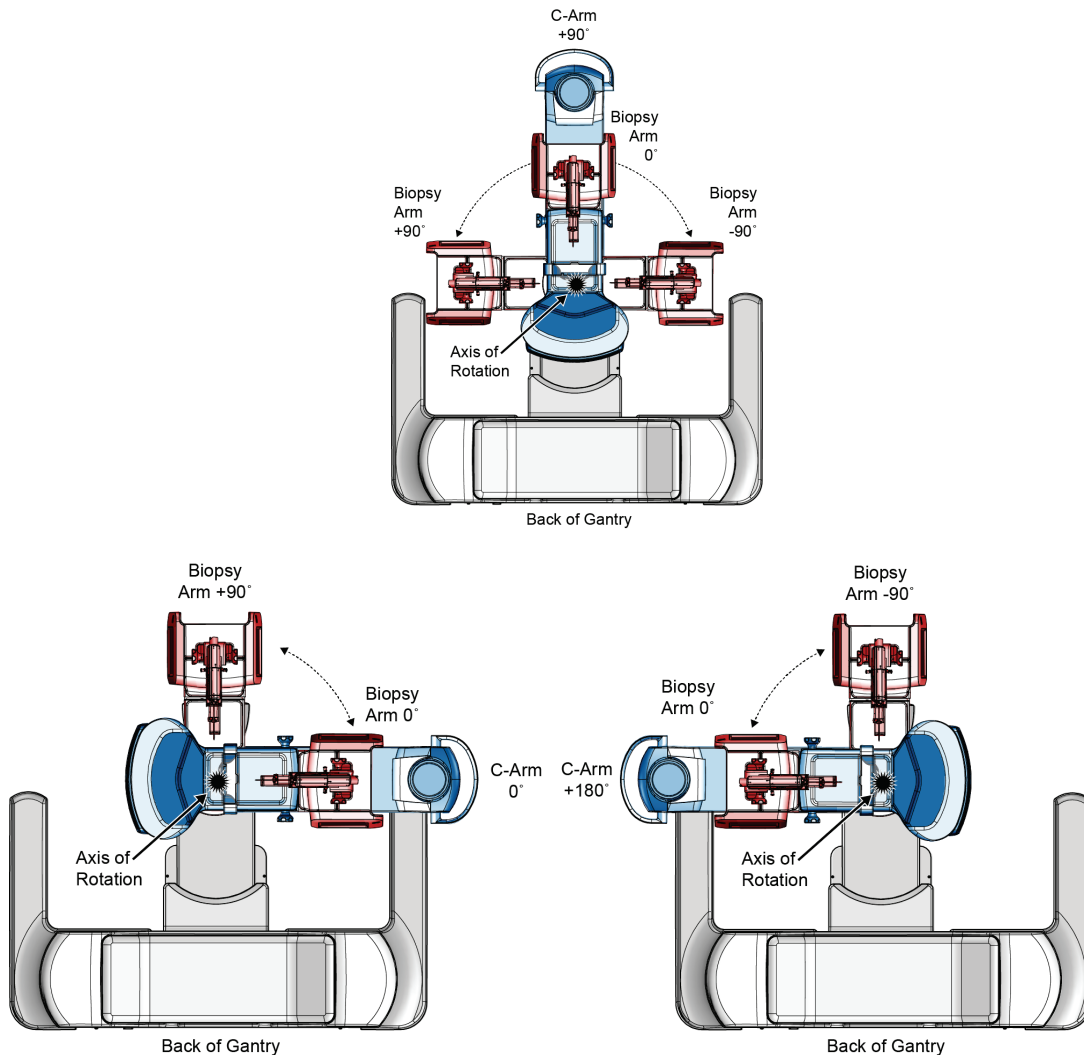

Figure 40: Biopsy Arm Angles of Rotation

8.2 Biopsy Coordinate System

The system uses a left-handed coordinate system. Left and right directions are in relation to the breast platform. The X direction is the medial-lateral axis (chest wall) with the positive direction to the right of the breast platform. The Y direction is the chest wall to the nipple axis with the positive direction pointed down. The Z direction is the breast platform to the breast paddle axis with the positive direction pointed away from the breast platform.

The 0, 0, 0 coordinate is located at the center top edge of the breast platform.

- X = 0 at horizontal center of the breast platform
- Y = 0 at the top edge of the breast platform
- Z = 0 at the surface of the breast platform

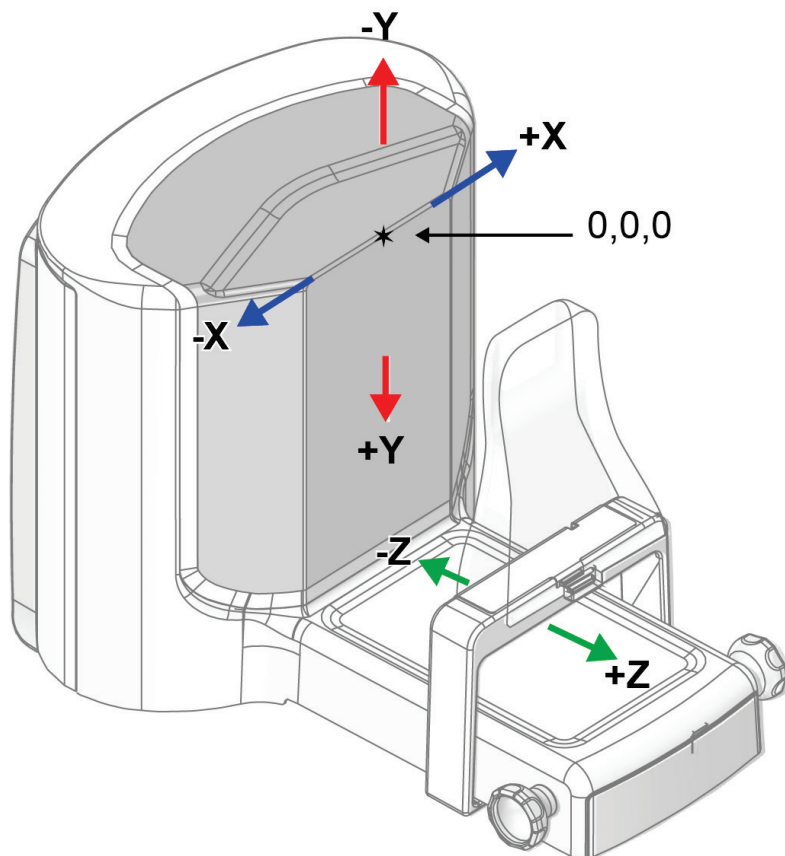

Figure 41: X, Y, Z Axes

8.3 Biopsy Tab

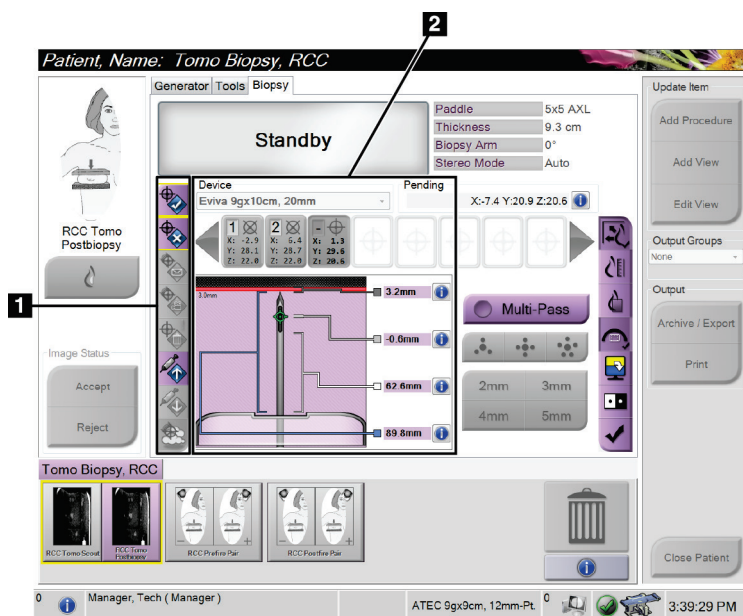

Figure Legend

1. Target Function Buttons
2. Biopsy Options Area

Figure 42: Biopsy Tab

When you select the **Biopsy** tab, the Biopsy Options appear. The Biopsy Options area of the screen shows information about the targets and the biopsy device installed on the system. The buttons on the left side of this area let you send selected targets to the Biopsy Control Module. Refer to [Biopsy Options](#) on page 66 for information about the button functions and data fields on the **Biopsy** tab.

8.3.1 Biopsy Options

The buttons in the Biopsy Options area communicate target information to the Biopsy Control Module. The area on the right side of the buttons shows the selected targets and biopsy device (items 9 and 10).

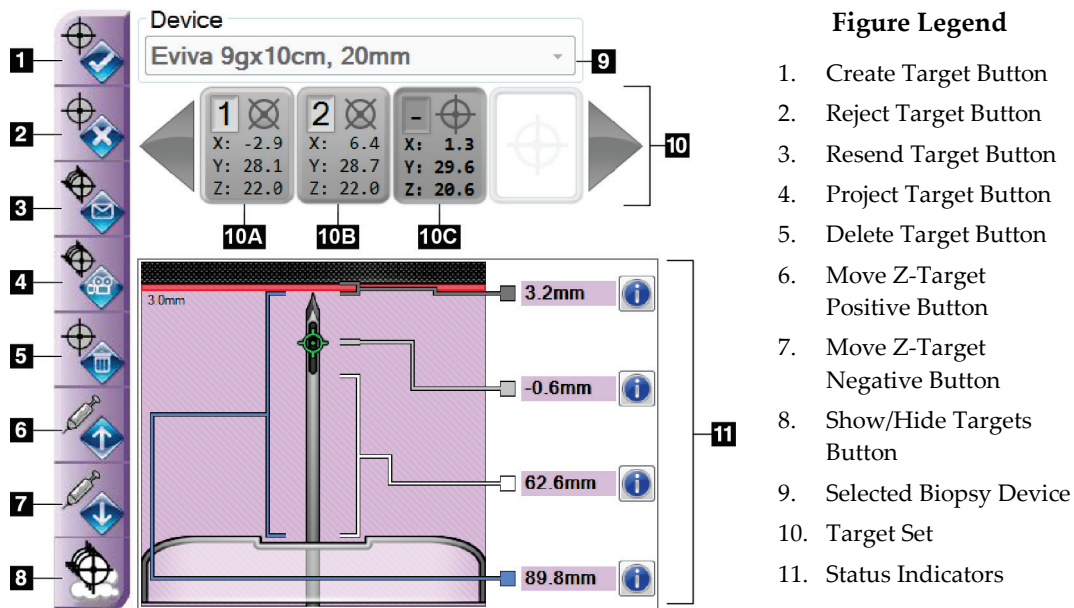

Figure 43: Function Buttons and Data on the Biopsy Tab

Figure Legend

1. **Create Target** assigns target points and creates a target coordinates icon in the target set (item 10). After you assign the target, select the button a second time to accept the target and transfer the target coordinates to the Biopsy Control Module.
2. **Reject Target** removes the selected target from the list of target coordinates if that target has not been accepted.
3. **Resend Target** resends the selected target coordinates to the Biopsy Control Module.
4. **Project Target** shows the selected target on an additional stereo pair on the Image Display monitor.
5. **Delete Target** deletes the selected target from the list of target coordinates if that target was accepted.
6. **Move Z-Target Positive** moves the final position of the needle away from the Breast Platform and the graphic of the lesion downward. The values for the safety margins change accordingly.
7. **Move Z-Target Negative** moves the final position of the needle toward the Breast Platform and the graphic of the lesion upward. The values for the safety margins change accordingly.
8. **Show/Hide Targets** shows/hides all targets in the list of targets on the Image Display monitor.

9. **Device** shows the name of the selected biopsy device that was chosen from the drop-down list.



Warning:

Patient injury can occur if the device you select in the Biopsy tab is not the device that is installed on the system.

10. **Target Set** displays all the biopsy targets that have been assigned and/or accepted in this session. You can generate multiple targets up to a maximum of twelve target points. Use the left and right arrow keys to scroll through the target set if necessary.
- Target #1 - The "1" indicates the target number that has been assigned and is accepted (based on the creation order). A yellow border around the target indicates that it is the active target at the Biopsy Control Module. A single point in the crosshairs indicates that it is a single point target. An asterisk (*) indicates that the target coordinates were later changed at the Biopsy Control Module.
 - Target #2 - The "2" indicates the target number that has been assigned and is accepted (based on the creation order). Multiple points in the crosshairs indicate that it is a multiple point target generated by the Multi-Pass feature (refer to [Lesion Targeting Using Multi-Pass](#) on page 72).
 - Target blank - No number indicates that the coordinates are assigned but not accepted (a user has not selected the **Create Target** button a second time). A single point in the crosshairs indicates that it is a single point target. A depressed target coordinates icon indicates that it is the active target *on the user interface*.



Note

The coordinates displaying on a Multi-Pass target icon represent the center point. Right click and hold on the target icon to view the coordinates of all of the points.

11. **Status Indicators** show the distance information:

- The distance from the needle tip (post fire) to the breast platform.
- The distance of the target from the center of the aperture.
- The distance between the Biopsy Paddle and the top of the aperture.
- The distance from the Biopsy Paddle to the needle tip.

The distance indicator fields change colors with movement of the needle.

- Purple indicates that it is safe to proceed.
- Red indicates that the current coordinates exceed the safety margin.
- Yellow warns of being near the safety limit.



Note

To make a target active, select a target coordinates icon from the target set and click the **Resend** button.

8.4 Stereotactic Lesion Targeting



Note

You can use the Zoom tool (in the **Tools** tab or **View Actual Pixels** button) to magnify the area of interest in an image.



Note

Make sure that the biopsy device is out of the imaging area.



Note

The overall targeting accuracy is equal to the combined targeting accuracy of the Biopsy Arm Controller and the biopsy device. When using the biopsy device, the maximum deviation from the target coordinate will not be more than 2 mm from either side.

1. Acquire a stereo pair of images.
 2. Select the **Accept** button to save the stereo images.
-



Note

Your Service representative can configure the system to Auto-Accept new images.

3. Click in the area of interest of the lesion in one of the stereo images.
 4. Select the other stereo image, then click in the area of interest of the lesion.
 5. Select the **Create Target** button to save the target. The active target set automatically transmits to the Biopsy Control Module with the creation of each new target.
 6. Repeat this procedure to create multiple targets (a maximum of twelve).
-



Note

The target that shows on the *Target Guidance* screen of the Biopsy Control Module is the last target created. The target or target set that shows on the *Select Target* screen is the last target or target set sent to the Biopsy Control Module.



Note

To target a lesion, you can also use the Scout and one of the stereo images.

8.4.1 Lateral Approach

Use a lateral approach when it is apparent that the lesion is not reachable with a standard approach or is close to the breast platform.

1. Position the biopsy device fully back on the Biopsy Arm away from the paddle.
2. Press and hold the **Lock** icon on the Biopsy Control Module taskbar to unlock the Biopsy Arm. After the **Lock** icon changes to unlocked, you can move the Biopsy Arm.

**Note**

If it is not safe to move into a lateral approach, an alarm message shows on the Biopsy Control Module taskbar. Move the biopsy device as needed.

3. Move the Biopsy Arm to the desired side of approach. As the Biopsy Arm moves, watch the Biopsy Control Module taskbar. When the light on the taskbar changes to a green dot, stop moving the Biopsy Arm and hold it in place. The Biopsy Arm detents and locks, and the Biopsy Control Module **Lock** icon automatically changes to locked status.

**Note**

Depending on the C-arm position, Biopsy Arm movement can be limited.

4. Any active targets are deleted. Follow the steps for lesion targeting to create the new lateral targets.

8.4.2 Verify the Position of the Biopsy Device

1. If desired, acquire the pre-fire images as necessary to identify the correct needle position.
 - Verify the needle position.
 - If necessary, make adjustments.
2. If applicable, fire the biopsy device.
3. If desired, acquire the post-fire images.
 - Verify the needle position.
 - If necessary, make adjustments.
4. If desired, acquire specimens with the attached biopsy device.
5. If desired, acquire post procedure images.

8.5 Lesion Targeting with Tomosynthesis

Lesion targeting for tomosynthesis requires system licenses for tomosynthesis biopsy.



Note

Make sure that the biopsy device is out of the imaging area.



Note

The overall targeting accuracy is equal to the combined targeting accuracy of the Biopsy Arm Controller and the biopsy device. When using the biopsy device, the maximum deviation from the target coordinate will not be more than 2 mm from either side.

1. Acquire the Tomographic target (scout) image.
 - If your system is set to Auto Accept, the Tomographic target (scout) cine runs briefly and then the system automatically accepts the image.
 - If Auto Accept is not set, the cine stops after two passes through the slice deck (or if the **Accept** button is pressed before the second cine run finishes).
2. Use the scroll wheel to scroll through the slices of the Tomographic target (scout) to find the best view of the lesion.
3. Click on the lesion.
 - A line appears in the Slice Indicator beside the selected slice.
 - The X, Y, and Z values for the target are established automatically at the area of the click.
4. Select the **Create Target** button to save the target. The active target set automatically transmits to the Biopsy Control Module.
5. Repeat steps 2 through 4 to create multiple targets (a maximum of twelve).



Note

The target that shows on the *Target Guidance* screen of the Biopsy Control Module is the last target created. The target or target set that shows on the *Select Target* screen is the last target or target set sent to the Biopsy Control Module.

8.5.1 Lateral Approach

Use a lateral approach when it is apparent that the lesion is not reachable with a standard approach or is close to the breast platform.

1. Position the biopsy device fully back on the Biopsy Arm away from the paddle.
2. Press and hold the **Lock** icon on the Biopsy Control Module taskbar to unlock the Biopsy Arm. After the **Lock** icon changes to unlocked, you can move the Biopsy Arm.



Note

If it is not safe to move into a lateral approach, an alarm message shows on the Biopsy Control Module taskbar. Move the biopsy device as needed.

3. Move the Biopsy Arm to the desired side of approach. As the Biopsy Arm moves, watch the Biopsy Control Module taskbar. When the light on the taskbar changes to a green dot, stop moving the Biopsy Arm and hold it in place. The Biopsy Arm detents and locks, and the Biopsy Control Module **Lock** icon automatically changes to locked status.



Note

Depending on the C-arm position, Biopsy Arm movement can be limited.

4. Any active targets are deleted. Follow the steps for lesion targeting to create the new lateral targets.

8.5.2 Verify the Position of the Biopsy Device

1. If desired, acquire the pre-fire images as necessary to identify the correct needle position.
 - Verify the needle position.
 - If necessary, make adjustments.
2. If applicable, fire the biopsy device.
3. If desired, acquire the post-fire images.
 - Verify the needle position.
 - If necessary, make adjustments.
4. If desired, acquire specimens with the attached biopsy device.
5. If desired, acquire post procedure images.

8.5.3 Project Targets on Post-Tomographic Scout Image

To project targets from the pre-fire Tomographic Target (scout) onto the post-fire Tomographic Target (scout), follow these steps:

1. Select the pre-fire Tomographic Target (scout) thumbnail. The image shows in the bottom half of a 2-Up screen on the Image Display monitor.
2. Select the post-fire Tomographic Target (scout) thumbnail. The image shows in the bottom half of the 2-Up screen.
3. Select the **Project Target** button in the Biopsy Options area to show the pre-fire targets on the post-fire Tomographic Target (scout).

8.6 Lesion Targeting Using Multi-Pass

The Multi-Pass feature allows you to automatically generate up to five offset target points all equidistant (up to 5 mm away) from the original target.

Multi-Pass can work with either stereo or tomographic biopsy images.

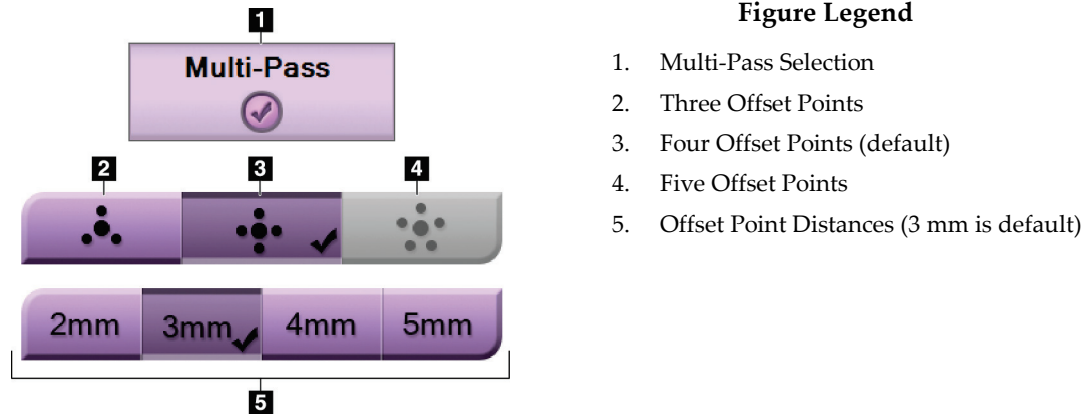

Figure 44: Multi-Pass Options



Note

Make sure that the biopsy device is out of the imaging area.



Note

The overall targeting accuracy is equal to the combined targeting accuracy of the Biopsy Arm Controller and the biopsy device. When using the biopsy device, the maximum deviation from the target coordinate will not be more than 2 mm from either side.

1. Acquire a stereo pair or tomographic image.
2. Locate the region of interest for the lesion. Click on the lesion, either on both stereo images or on the best tomographic slice.
 - A circle with crosshairs displays around the target point.
 - The X, Y, and Z values for the target are established at the lesion.
 - [Tomographic images] A line appears in the Slice Indicator beside the selected slice.
3. Select the **Create Target** button. A target coordinates icon displays on the list of targets.
4. Select the **Multi-Pass** button.

5. Select the number of offset target points (three, four, or five) you require around the center target point.

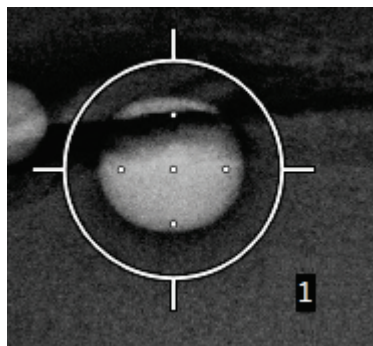

Figure 45: Four Offset Target Points Established Around Center Target Point



Note

Keep in mind that the center target point is included in the total target points. Choosing a "four" offset, for example, generates a total of five target points.

6. Select how far the offset target points are automatically generated from the center target point - 2 mm, 3 mm (the default), 4 mm, or 5 mm.

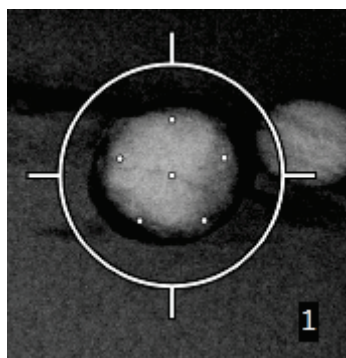

Figure 46: 3 mm Spacing of Offset Points

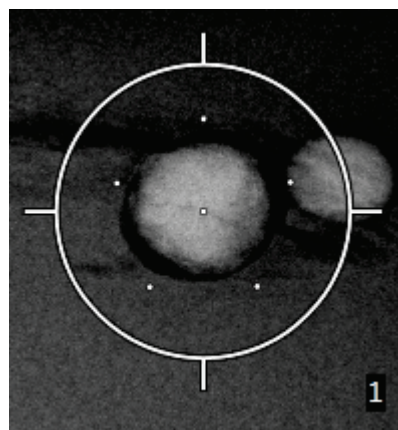

Figure 47: 5 mm Spacing of Offset Points

The crosshairs pattern for the target changes when the target is selected or deselected. See the following figures.

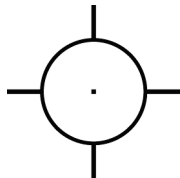

Figure 48: Single Point Target Selected



Figure 49: Single Point Target Deselected

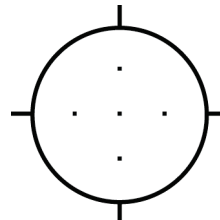

Figure 50: Multi-Pass Target Selected

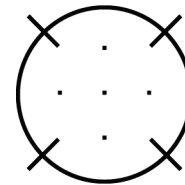

Figure 51: Multi-Pass Target Deselected

7. Select the **Create Target** button to accept the Multi-Pass target. The target becomes the active target coordinates icon on the target set and the coordinates are sent to the Biopsy Control Module.



Note

The coordinates displaying on a Multi-Pass target icon represent the center point. Left-click and hold on the target icon to view the coordinates of all of the points.



Note

A maximum of twelve target points can be generated at any one time. As the number of target points increase in the target set being created, the available Multi-Pass options change to reflect the balance of target points that are available for assignment. For example, in a scenario where seven target points have already been created, then only the "three" and "four" offset target options in Multi-Pass become available. This is because the "three" and "four" offset options are the only ones capable of generating twelve or less target points when totaled with the other seven target points.

8. The biopsy order of the target points is as follows:
 - The number displayed at the bottom right of the crosshairs circle indicates the order between target sets. The first target is labeled "1", the second is "2", and so on. See the following figure.

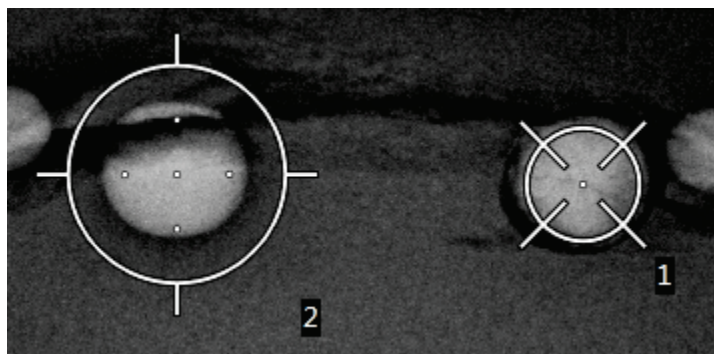

Figure 52: Example of Biopsy Order of Target Sets

- The order within a Multi-Pass target starts at the center target point. After the center target point, the order moves to the 12 o'clock position and continues counter-clockwise through the offset points. See the following figures.

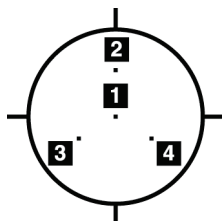

Figure 53: Biopsy Order of a Three Offset Target

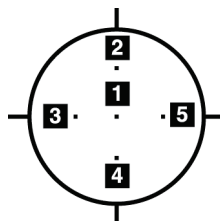

Figure 54: Biopsy Order of a Four Offset Target

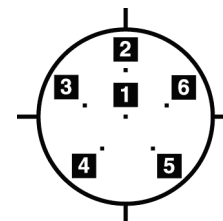

Figure 55: Biopsy Order of a Five Offset Target

- Verify the position of the Biopsy Device (refer to [Verify the Position of the Biopsy Device](#) on page 69). If necessary, observe the targets on post-Tomosynthesis scout images (refer to [Project Targets on Post-Tomographic Scout Image](#) on page 71).

8.7 Post Biopsy

- Put in a biopsy site marker, if desired.
- Move the biopsy device away from the breast.
- Acquire images as necessary.
- Release compression.

Chapter 9 System Administration Interface

9.1 The About Screen

The About screen provides information about the machine, such as system level, IP address, and serial number. This type of data can be useful when working with Hologic to configure the system or resolve a system issue.

The screen is accessed in two ways:

- From the *Select Patient* screen - select the **Table** icon (on Taskbar) then select **About...**
- From the *Admin* screen - select **About** (in System Grouping)

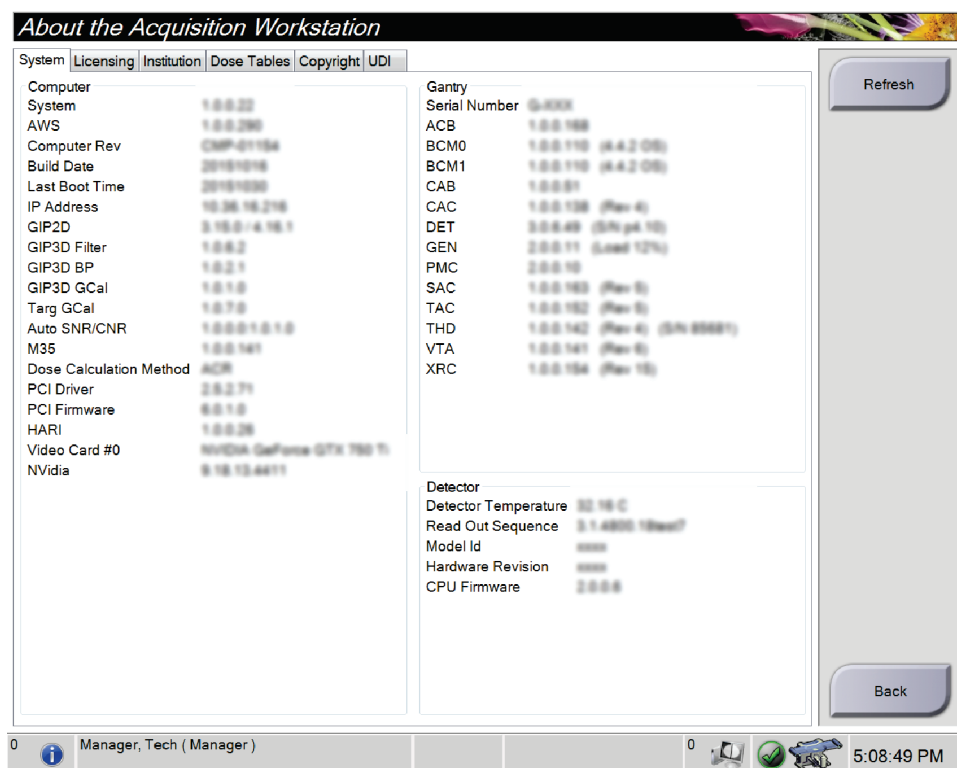

Figure 56: About Screen with the System Tab Showing

There are five tabs on the *About* screen:

- **System Tab** (default) - lists system configuration information
- **Licensing Tab** - lists the Hologic-licensed options installed on this machine
- **Institution Tab** - lists the name and address of the organization assigned to this machine
- **Copyright Tab** - lists the copyrights of Hologic and third-party software installed on this machine
- **UDI Tab** - lists the unique device identifier(s) of this machine

9.2 The Admin Screen

To access all functions in this screen, log in to the system as a user with administrator, manager, or service permissions.

Refer to the following table for descriptions of the *Admin* screen functions.



Figure 57: Admin Screen

Table 9: Admin Screen Functions

Section	Button Name	Function
Operators	Manage Operators	Add, delete, or change Operator information.
	My Settings	Change the information for the current Operator.
Procedures	Procedure Editor	Add or edit the procedures, or change the view order for each user.
	Procedure Order	Change the procedure list order.
	View Editor	Add or edit the views.
	QAS	Access the <i>QAS Test</i> screen.
Quality Control	Quality Control	Select a Quality Control task to perform or mark completed.
	QC Report	Create a QC Report.
	Test Patterns	Select and send the test patterns to output devices.
	Reject and Repeat Report	Create a Reject and Repeat Report.
System	System Tools	The Interface for Service for the configuration of and identification of problems in the Acquisition Workstation.
	System Defaults	Set the Gantry default values.
	System Diagnostics	Displays the status of all subsystems.
	Preferences	Set the system preferences.
	About	Describes the system. Refer to The About Screen on page 77.
	Exposure Report	Create a report of the number of exposures by modality.
	Biopsy Devices	Set and manage the biopsy devices.
Connectivity	Query Retrieve	Query the configured devices.
	Import	Import the data from a DICOM source.
	Manage Output Groups	Add, delete, or edit output groups.
	Incoming Log	Shows log entries for images that do not import during manual import or DICOM store.
	Archive	Send local studies to networked storage or export to removable media devices.
You must have permission to access all features. The permission level controls the functions you can change.		

9.3 How to Access the System Tools

The Radiologic Technologist Managers and users with Service permissions can access the System Tools function. The System Tools function contains the configuration information about the system.

1. Log in as Tech Manager or Service.
2. When the *Select Function to Perform* screen appears, select the **Admin** button.
3. From the System area of the *Admin* screen, select **System Tools**.

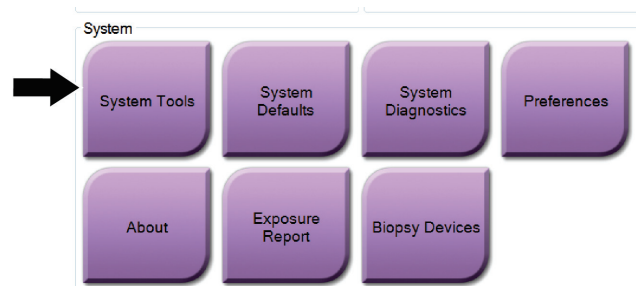

9.3.1 System Tools for the Radiologic Technologist Manager

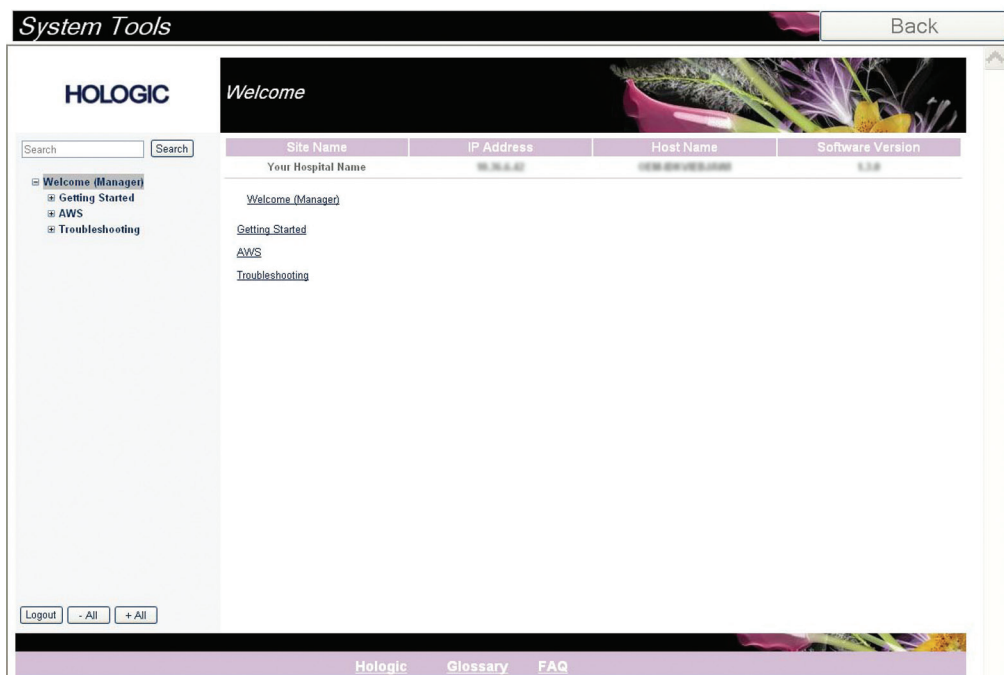

Figure 58: The System Tools Screen

Table 10: Radiologic Technologist Manager—System Tools Functions

Section	Screen Functions
Getting Started	<p>About: The introduction to the service tool.</p> <p>FAQ: List of common questions.</p> <p>Glossary: List of terms and descriptions.</p> <p>Platform: List of directories, software version numbers, and system software statistics.</p> <p>Shortcuts: List of Windows shortcuts.</p>
AWS	<p>Connectivity: List of Installed Devices.</p> <p>Film & Image Information: Create an Image Report*. Create a QC Report. (*You can also access this report from a remote computer. Refer to Remote Access to Image Reports on page 82.)</p> <p>Licensing: List of Installed Licenses.</p> <p>User Interface: Change the options in the Software application.</p> <p>Internationalization: Select the local language and culture.</p>
Troubleshooting	<p>AWS: Allows for download of images.</p> <p>Computer: System Management and Network Information.</p> <p>Log: Change the event record options.</p> <p>Backups: Control the backups for the system.</p>

9.3.2 Remote Access to Image Reports

Access image reports via a remote computer networked to the system. This function can be useful for sites that do not permit USB downloads of reports directly from the system.

Follow these steps to access image reports from a remote computer. You must log in to the System Tools as a Manager-level user for this procedure.

1. Get the IP Address for the system you want to access. You can get the IP Address from your IT administrator or from the system. From the system, go to **Select Patient Screen > "Tube Icon" on Taskbar > About... > System Tab > IP Address**. Write down the IP Address.
2. Using an internet browser on your remote computer, navigate to `http:// [IP address]/Hologic.web/MainPage.aspx`. Use the IP Address from step 1.
3. The *Service Tools Logon* screen displays. Type a Manager-level user name and password, and then click **Submit**.

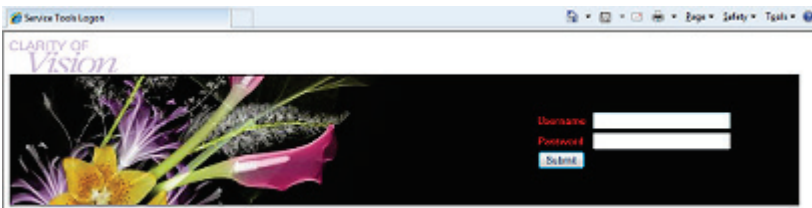

Figure 59: Remote Logon Screen for Service Tools

4. The *Service Tools Welcome* screen displays. Go to **AWS > Film & Image Information > Create Image Report**.

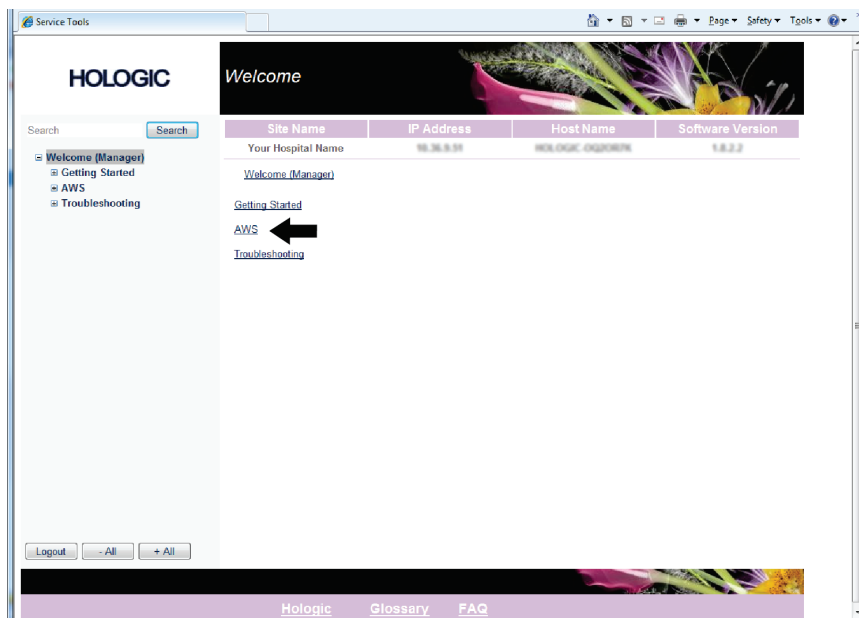

Figure 60: Service Tools Welcome Screen

5. Select the parameters for the report and click **Generate**.

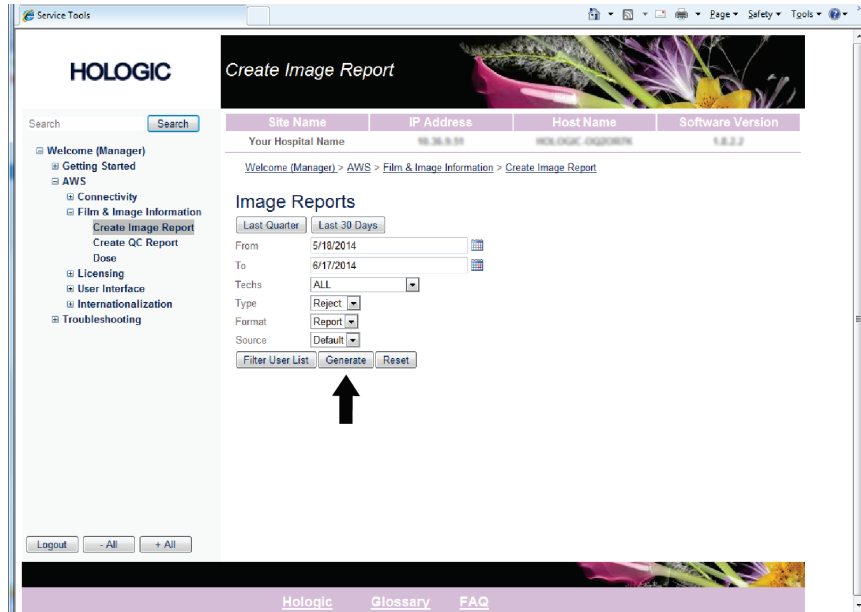

Figure 61: Create Image Report Parameters

6. The report shows on the screen. Scroll to the bottom of the report and select either **Click to Download (html)** or **Click to Download (csv)** for the file download type. Click **Save** when prompted.

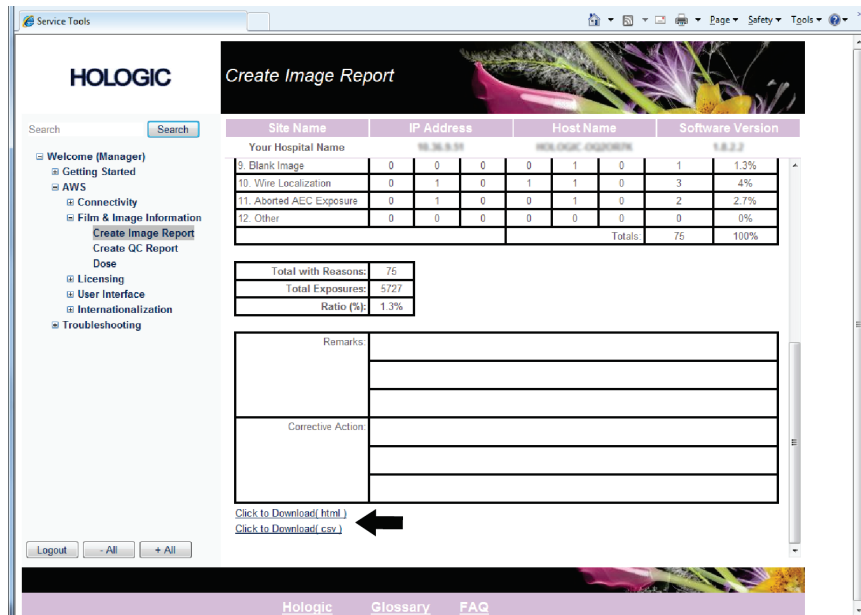

Figure 62: Create Image Report

7. Select a folder on the computer, and then click **Save**.
8. **Log out** from Service Tools when finished.

9.4 How to Use the Archive Tool

The archive feature in the *Admin* screen lets you:

- Send local studies to an archive.
- Export studies to removable media.

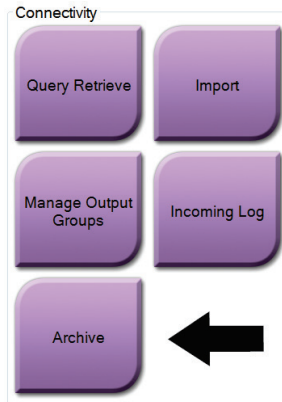

Figure 63: Archive Button

1. Select the **Archive** button in the *Admin* screen to show the *Multi Patient On Demand Archive* screen.
2. To search for a patient, enter at least two characters in the Search parameters area and click the magnifying glass.

A list of patients that match the search criteria displays.

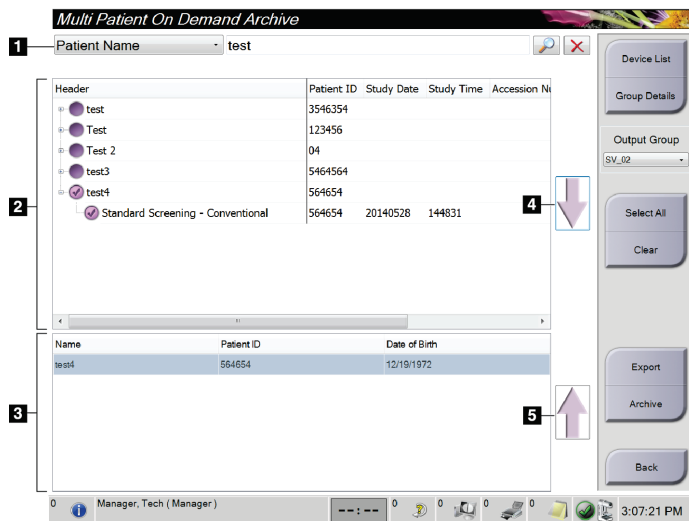

Figure 64: Multi Patient On Demand Archive Screen

Figure Legend

1. Search parameters
2. Patient List area
3. Patients To Be Archived area
4. Add selection in the Patient List area to the Patients To Be Archived area
5. Remove the selection from the Patients To Be Archived area

To Archive:

1. Select patients and procedures.
 - Select patients from the patient list, or do a search with the search parameters (item 1) and select patients from the search results.



Note

The **Select All** button (on the right side of the screen) selects all the patients in the Patient List area. The **Clear** button (on the right side of the screen) clears selections.

- Select the procedures for each patient.
 - Select the **Down Arrow** (item 4) on the screen to move the selected patients to the Patients To Be Archived area (item 3).
 - Select the **Up Arrow** (item 5) on the screen to remove the selected patients from the Patients To Be Archived area (item 3).
2. Select a storage device.
 - Select an option from the Stored Device drop-down menu.
- OR
- Select the **Group List** button, then select an option.
3. Select the **Archive** button. The list in the Patients To Be Archived area copies to the selected archive devices.



Note

Use the Manage Queue utility in the taskbar to review the archive status.

To Export:

1. Select patients and procedures.
 - Select patients from the patient list, or do a search with one of the search parameters (item 1) and select patients from the search results.



Note

The **Select All** button (on the right side of the screen) selects all the patients in the Patient List area. The **Clear** button (on the right side of the screen) clears selections.

- Select the procedures for each patient.
 - Select the **Down Arrow** (item 4) on the screen to move the selected patients to the Patients To Be Archived area (item 3).
 - Select the **Up Arrow** (item 5) on the screen to remove the selected patients from the Patients To Be Archived area (item 3).
2. Select the **Export** button.
 3. In the *Export* dialog box, select the Target from the drop-down menu of media devices.

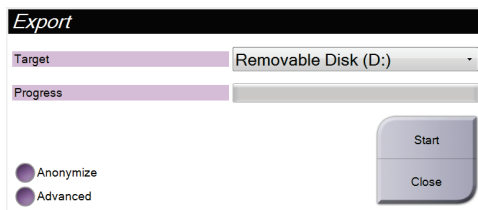

Figure 65: Export Screen

4. Select other options, if necessary:
 - **Anonymize**: to anonymize patient data.
 - **Advanced**: to select a folder on your local system to keep the selections, and also to select the Export types.
5. Select the **Start** button to copy the selected images to the selected device.

Chapter 10 Accessories

10.1 Maximum Comfort Package

General instructions for installation and use are given in the table below. For specific instructions for using the Arm Through accessories, see the table [Installation of the Arm Through Max Comfort Package](#) on page 89.

Table 11: Installation and Use of the Maximum Comfort Package

Step	What the step looks like
<p>1. Select the aperture.</p> <ul style="list-style-type: none"> • item 1 Standard • item 2 Large • item 3 Arm through (see the table Installation of the Arm Through Max Comfort Package on page 89). 	
<p>2. Install the aperture into the slot in the patient platform (item 1) then lower the aperture into position until the latch fastens (item 2).</p>	
<p>3. Select the aperture cushion.</p> <ul style="list-style-type: none"> • item 1 Maximum Access • item 2 Standard • item 3 Maximum Comfort 	
<p>4. Put the tabs by the hip of the patient.</p>	
<p>5. Put the cushion on the patient platform in the correct direction. Position the patient on the patient platform.</p>	

Affirm Prone Biopsy System User Guide

Chapter 10: Accessories

Table 11: Installation and Use of the Maximum Comfort Package

Step	What the step looks like
<p>6. Adjust the footrest.</p> <ol style="list-style-type: none">Pull and hold the knob on the footrest.Adjust the footrest: Rotate the footrest and pull out or push in to the desired position.Release the knob to lock the footrest.	
<p>7. Repeat for the headrest as needed.</p> <p>8. Use additional cushions for support as needed.</p> <ul style="list-style-type: none">item 1 Head cushionitem 2 Wedge cushionitem 3 Hip cushion	

Table 12: Installation of the Arm Through Maximum Comfort Package

Step	What the step looks like
1. Select the Arm Through accessories. <ul style="list-style-type: none"> • item 1 Aperture • item 2 Aperture cushion 	
2. Install the aperture into the slot in the patient platform (item 1) then lower the aperture into position until the latch fastens (item 2). 3. Install the aperture cushion.	
4. Rotate the C-arm to the approach angle. Install the armrest on the bottom of the C-arm.	

Table 13: Use of the Arm Through Maximum Comfort Package

Step	What the step looks like
<p>1. Position the patient on the patient platform.</p> <p>2. Position the arm of the patient on the arm support and lock the support into position. There are three locks:</p> <ul style="list-style-type: none"> • item 1 Position lock • item 2 Height lock • item 3 Bottom attachment lock 	

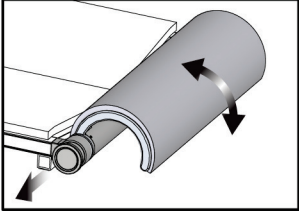
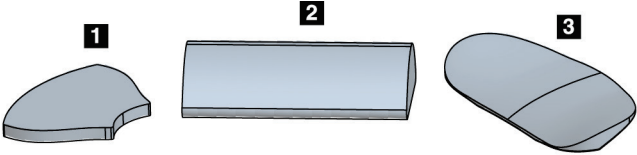
10.2 Paddles

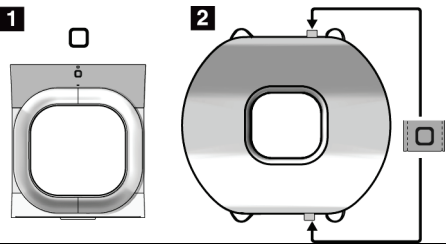
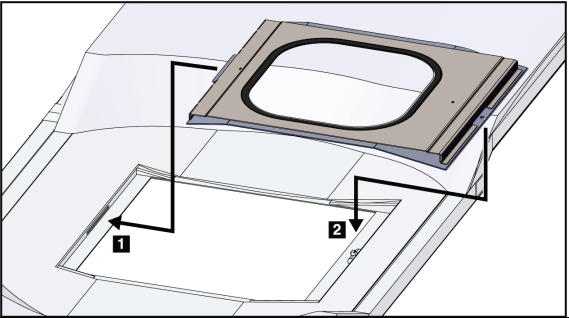
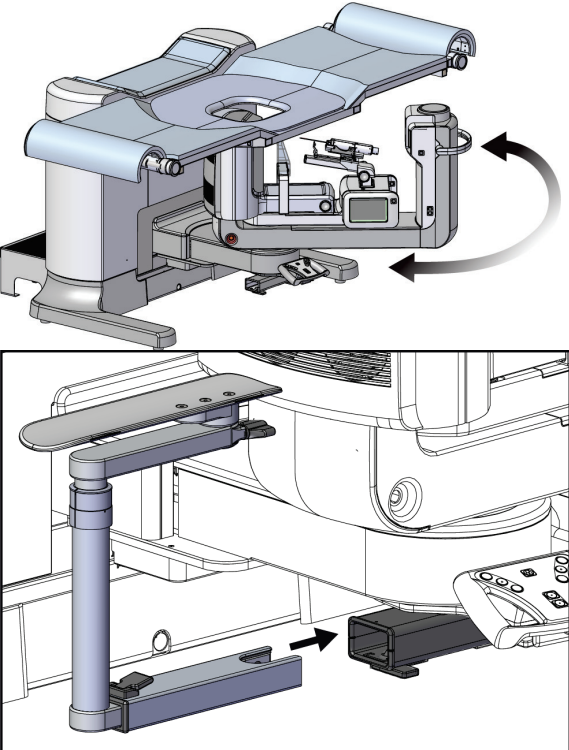
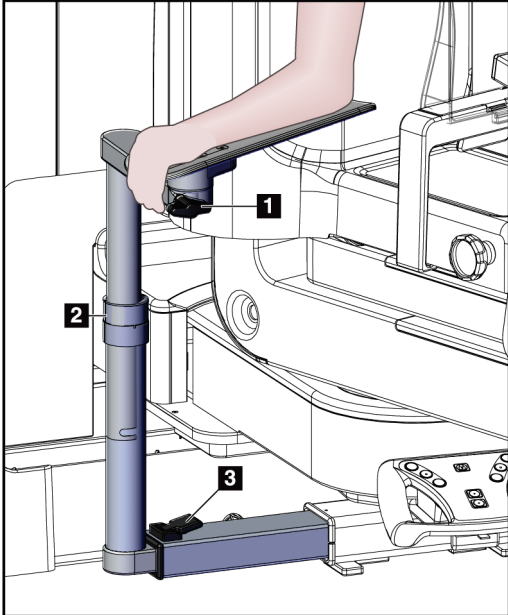

5 x 5 cm Axilla Paddle



5 x 5 cm Biopsy Paddle



6 x 7 cm Biopsy Paddle



15 cm Lateral Paddle

10.2.1 How to Install or Remove a Paddle

How to Install a Paddle:

1. Move the compression mechanism away from the breast platform.
2. Hold the paddle in one hand with the flat compression side facing the image receptor.
3. Tilt the paddle (between 30 and 45 degrees) toward the image receptor, then put the tabs of the paddle into the slots in the rear of the Compression Device.
4. Compress the Paddle Clamp with your free hand.
5. Rotate the paddle into a vertical position and release the Paddle Clamp to lock the paddle.

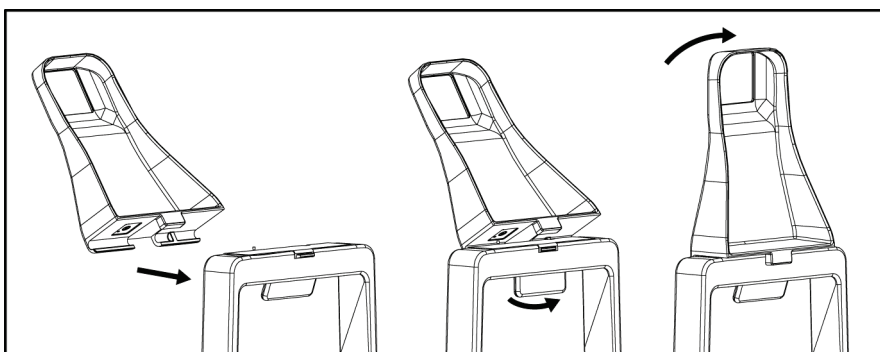

Figure 66: How to Install a Compression Paddle

How to Remove a Paddle:

1. Move the compression mechanism away from the breast platform.
2. Hold the paddle with one hand. Use the free hand to compress the Paddle Clamp to release the locked paddle.
3. Tilt the paddle toward the image receptor, and pull the paddle away from the Compression Device.
4. Release the Paddle Clamp.

10.3 Compatible Biopsy Devices

10.3.1 Biopsy Device Holder

To Install a Biopsy Device Holder:

1. Align the outer holes in the holder with the guide pins on the mount.
2. Align the center hole with the mount screw.
3. Turn the knob clockwise on the mount to attach the device holder.

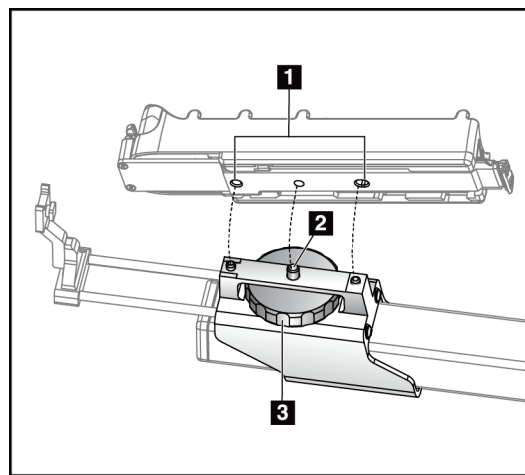

Figure Legend

1. Biopsy Device Holes
2. Mount Screw
3. Mount Knob

Figure 67: How to Install the Biopsy Device Holder

To Remove a Biopsy Device Holder:

1. Turn the knob counterclockwise on the mount to release the device holder.
2. Pull the device holder away from the mount.

10.3.2 Needle Guides



Warning:
Always use sterile techniques when you use Needle Guides during the patient procedures.



Warning:
It is important to install the device correctly. Be sure to insert the needle through the Needle Guides.

To Install a Disposable Needle Guide:

1. Align the Needle Guide so that the raised-square side of the Needle Guide fits between the two lobes of the Needle Guide Mount.
2. Slide the open area of the U-shape in the Needle Guide around the pin in the Needle Guide Mount.
3. Push the Needle Guide in until it locks into position.

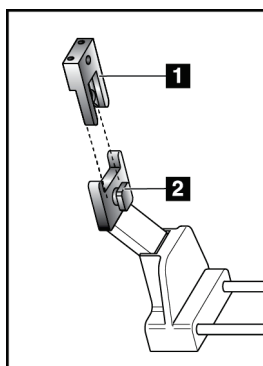

Figure Legend

1. Needle Guide
2. Needle Guide Mount

Figure 68: How to Install the Needle Guides



Note
The Needle Guides can look different from the Needle Guide shown.

To Remove a Disposable Needle Guide:

1. Remove the biopsy device.
2. Pull the Needle Guide away from the pin and remove from the Needle Guide Mount.
3. Discard the Needle Guide in accordance with local regulations.

10.3.3 Install a Biopsy Device on a Device Holder



Warning:

Always apply the device safety and cock the biopsy device before you install the device in the holder.

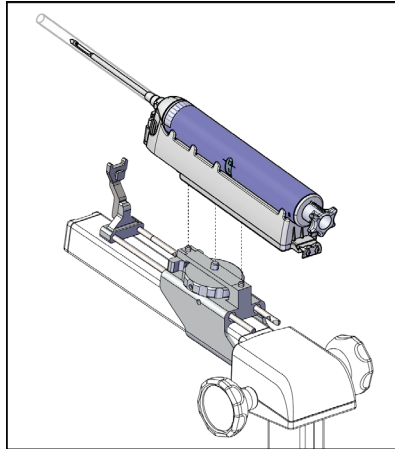

Figure 69: Install the Biopsy Device in the Device Holder

1. Turn the biopsy device knob to move the biopsy device holder fully back.
2. Install a needle guide on the Needle Guide Mount (refer to [Needle Guides](#) on page 93).
3. Move the Needle Guide Mount fully forward.
4. Slide the device fully into the holder from the rear (open end).
5. Make sure that the needle goes through the hole in the sterile needle guide.



Note

Refer to the biopsy device product information for specific installation instructions.

Chapter 11 Sample Clinical Sequences

11.1 Example Stereotactic Biopsy Procedure

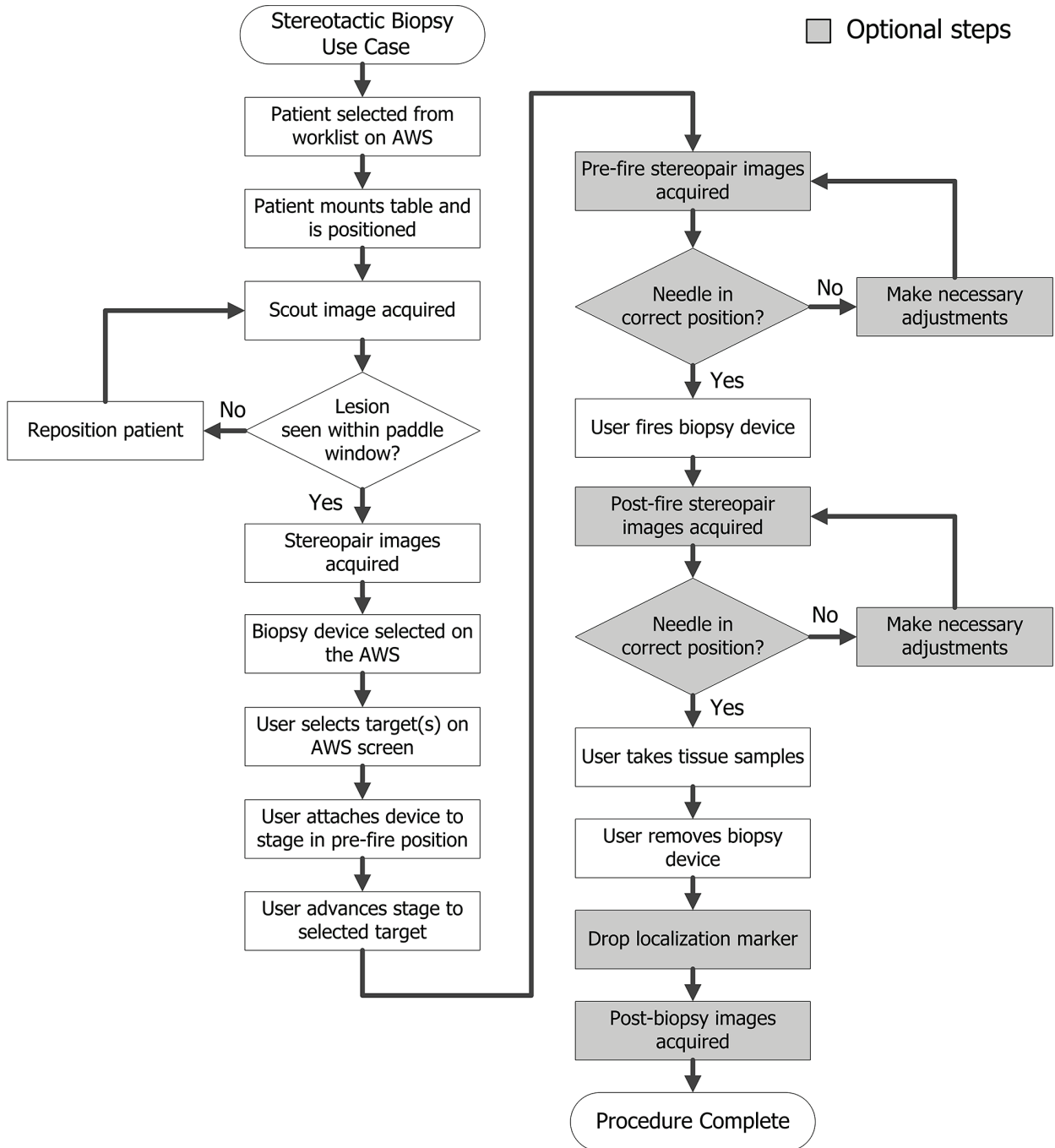

11.2 Example Tomography Biopsy Procedure

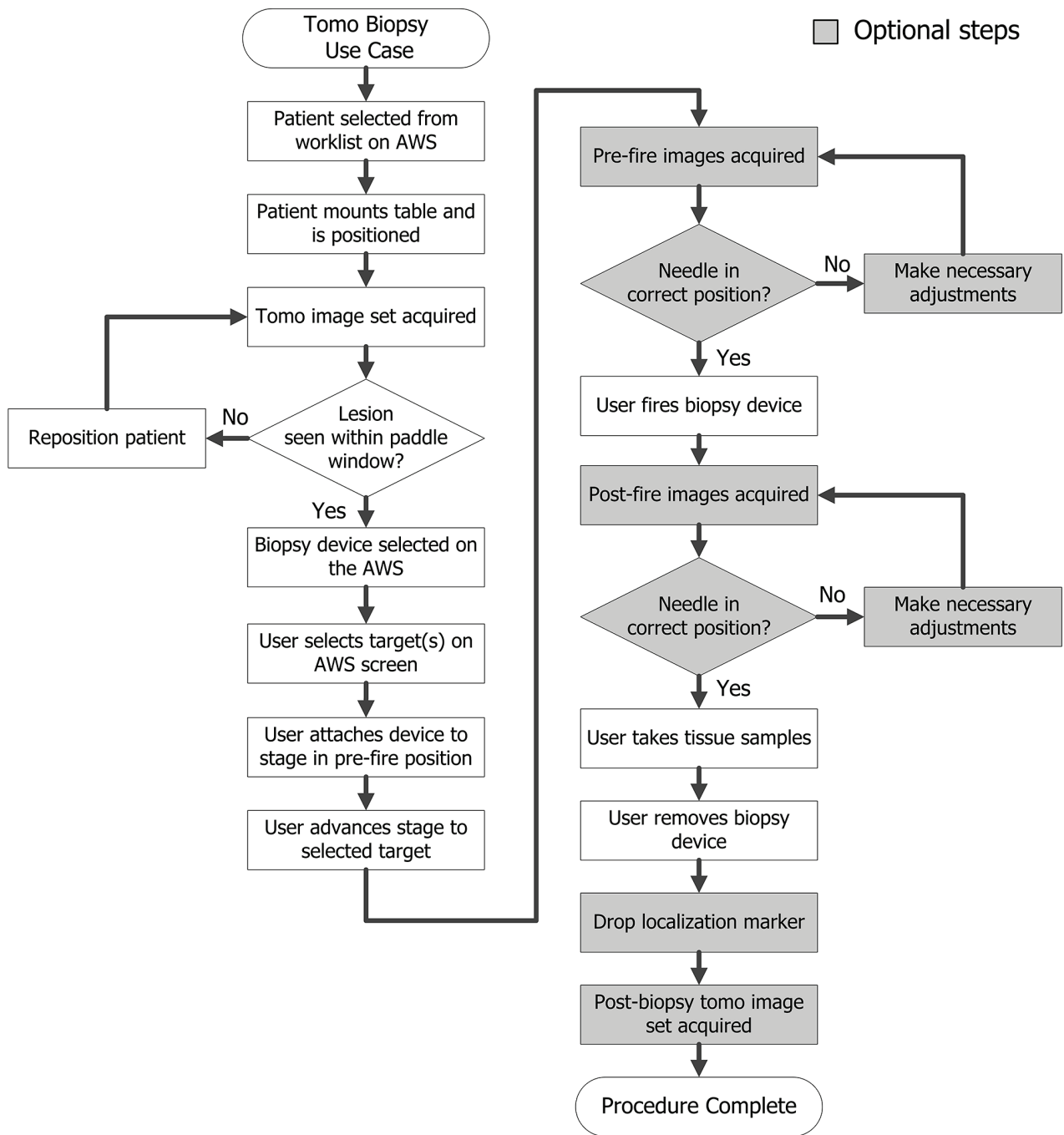

11.3 Example Sequence of Operation

Step

Where this action is done

At the Acquisition Workstation, select the patient name, procedure, and output (if desired).

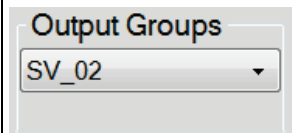
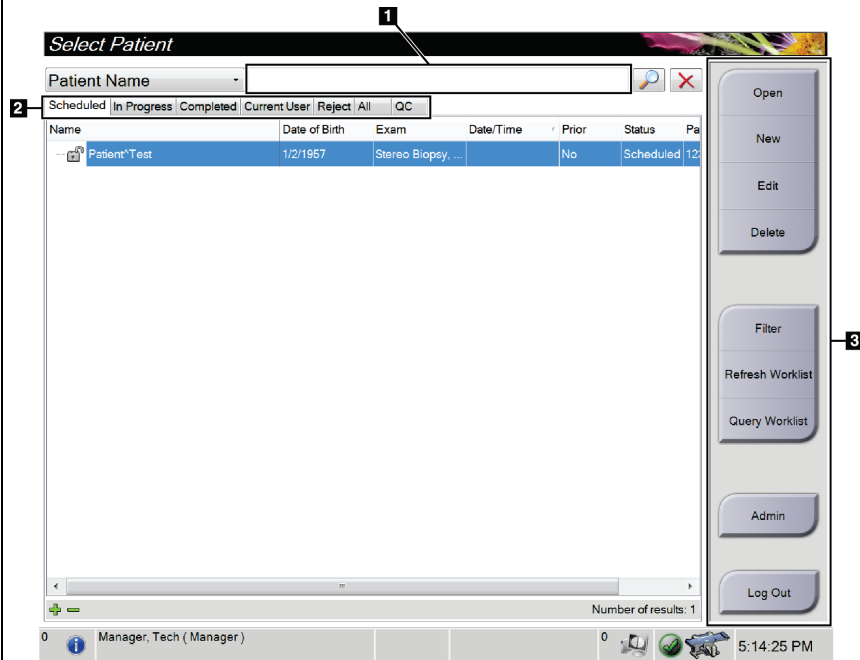

Affirm Prone Biopsy System User Guide

Chapter 11: Sample Clinical Sequences

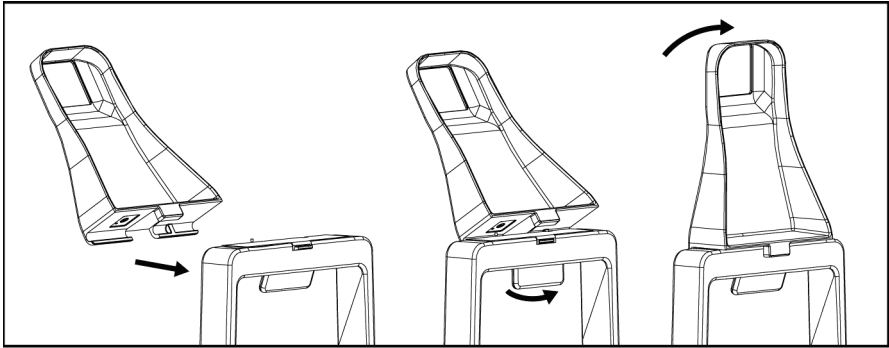
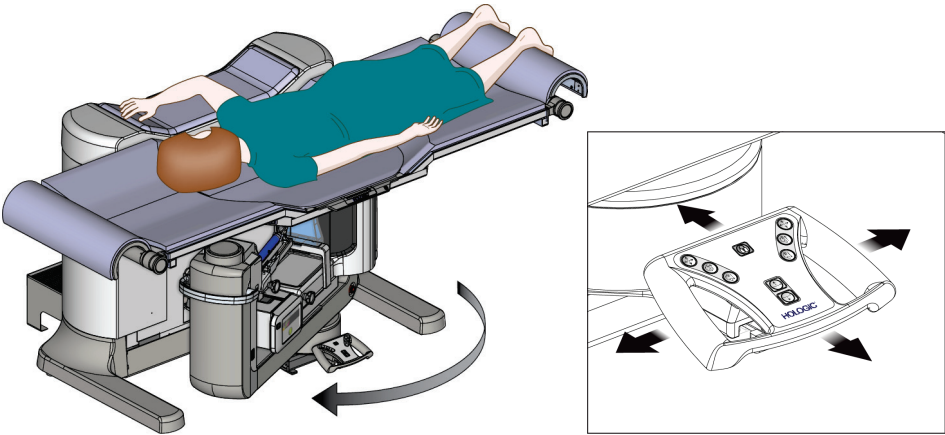
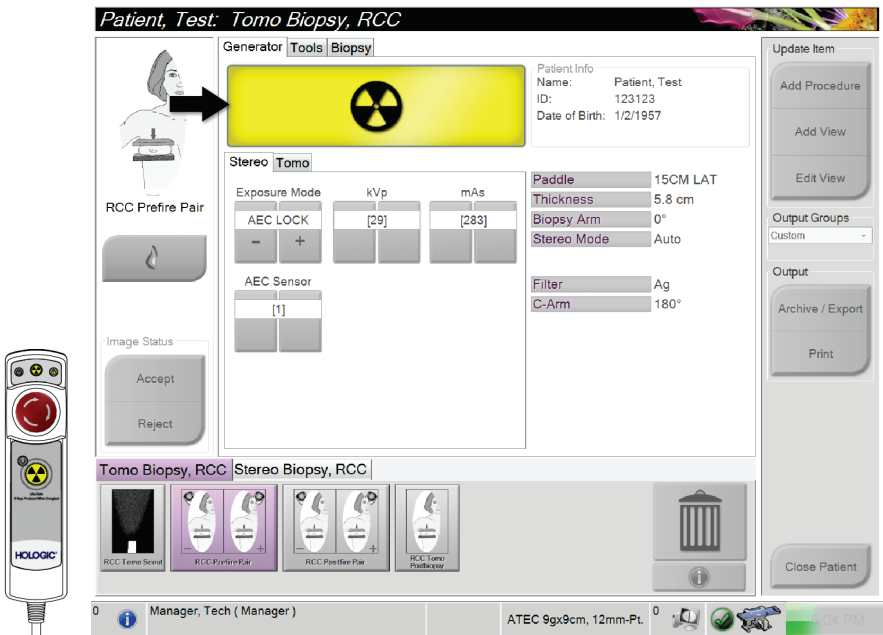
Step	Where this action is done
Install the biopsy paddle.	
Position the patient, the patient platform, and the C-arm.	
Acquire the image.	

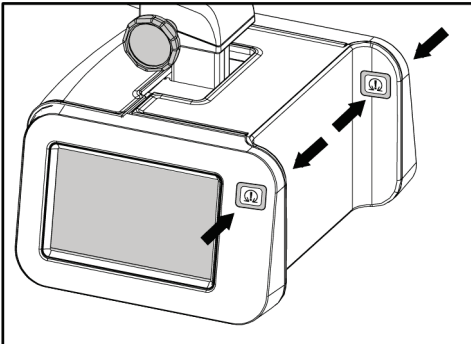
Step	Where this action is done
<p>On the Acquisition Workstation, target the lesion then accept the target to transmit it to the Biopsy Control Module.</p>	
<p>Enable the Biopsy Control Module motor.</p>	

Affirm Prone Biopsy System User Guide

Chapter 11: Sample Clinical Sequences

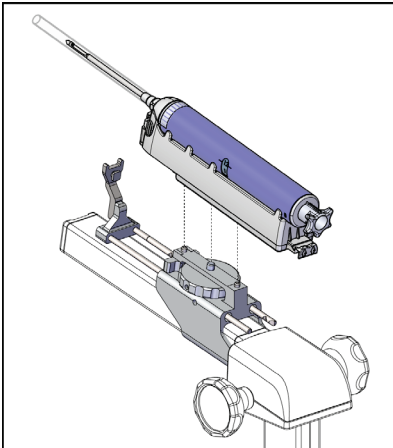
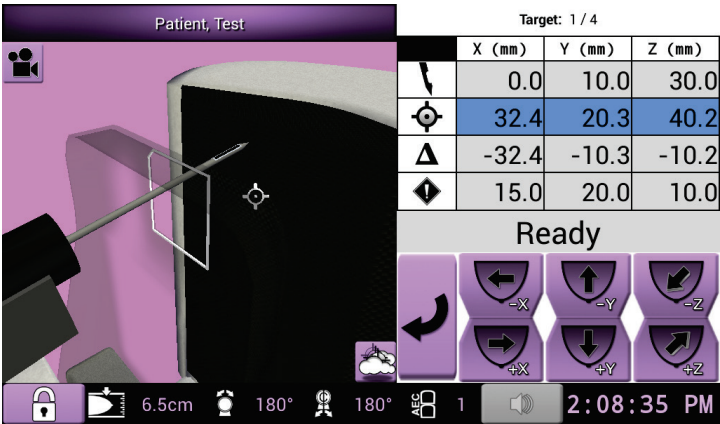
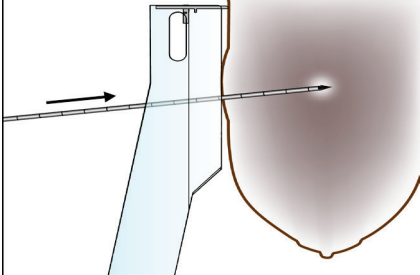
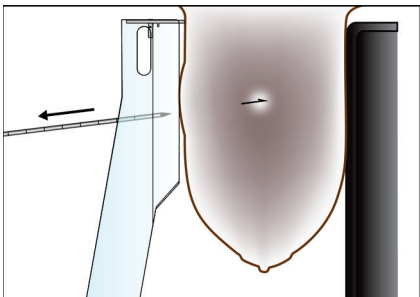
Step	Where this action is done																								
Attach the biopsy device.																									
Perform the biopsy.	 <table border="1" data-bbox="844 871 1166 1050"> <thead> <tr> <th colspan="4">Target: 1 / 4</th> </tr> <tr> <th></th> <th>X (mm)</th> <th>Y (mm)</th> <th>Z (mm)</th> </tr> </thead> <tbody> <tr> <td>↖</td> <td>0.0</td> <td>10.0</td> <td>30.0</td> </tr> <tr> <td>⊕</td> <td>32.4</td> <td>20.3</td> <td>40.2</td> </tr> <tr> <td>△</td> <td>-32.4</td> <td>-10.3</td> <td>-10.2</td> </tr> <tr> <td>⬇</td> <td>15.0</td> <td>20.0</td> <td>10.0</td> </tr> </tbody> </table> <p>Ready</p> <p>6.5cm 180° 180° 1 2:08:35 PM</p> 	Target: 1 / 4					X (mm)	Y (mm)	Z (mm)	↖	0.0	10.0	30.0	⊕	32.4	20.3	40.2	△	-32.4	-10.3	-10.2	⬇	15.0	20.0	10.0
Target: 1 / 4																									
	X (mm)	Y (mm)	Z (mm)																						
↖	0.0	10.0	30.0																						
⊕	32.4	20.3	40.2																						
△	-32.4	-10.3	-10.2																						
⬇	15.0	20.0	10.0																						
Insert a biopsy marker (if desired).																									

Step

Where this action is done

Acquire post-biopsy images (if desired).

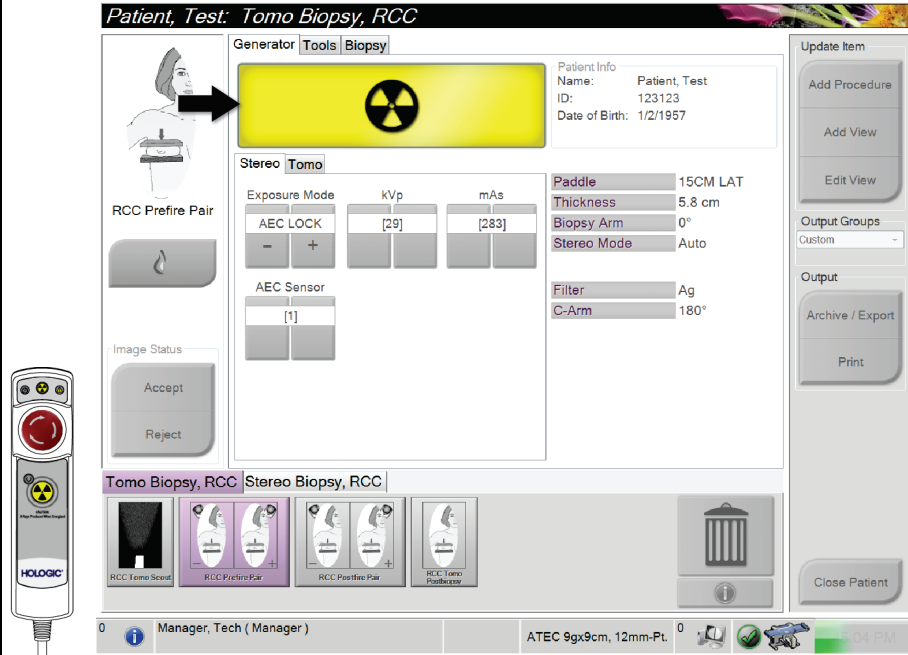

Release compression.
 Lower the patient platform.

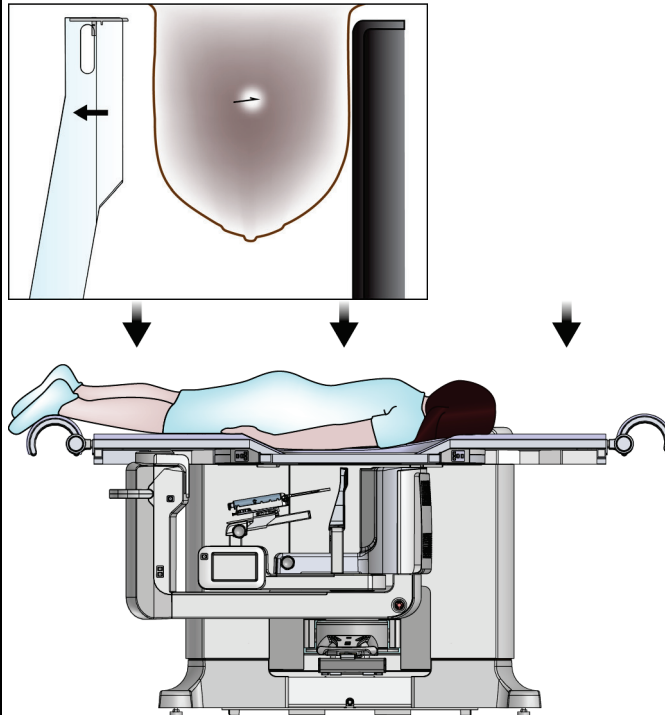

Affirm Prone Biopsy System User Guide

Chapter 11: Sample Clinical Sequences

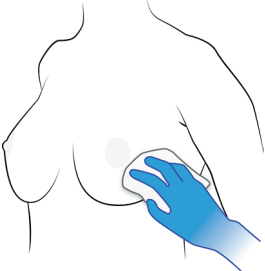
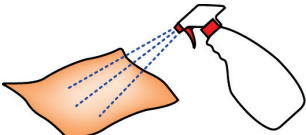
Step	Where this action is done
Apply pressure to the biopsy site as needed.	 An illustration showing a person's upper torso. A hand is shown applying pressure to a small, circular area on the chest, which is the biopsy site. The hand is colored blue.
Clean the system per cleaning instructions	 An illustration of a white spray bottle with a red nozzle. The bottle is tilted, and blue dashed lines represent the spray being directed onto an orange, rectangular surface.

Chapter 12 Quality Assurance

There are two ways to access the Quality Assurance and Quality Control Tasks.

- After logging in, the *Select Function to Perform* screen appears. This screen lists the quality tasks that are due.

Name	Last Performed	Due Date
QAS	1/6/2016	1/7/2016
Hardcopy Output Quality Test		1/12/2016
Gain Calibration	1/5/2016	1/11/2016
Phantom Image Quality Test	1/5/2016	1/11/2016
Visual Equipment Check		1/12/2016
Compression		1/12/2016
Repeat Analysis		1/12/2016

Number of results: 7

Manager, Tech (Manager) 5:18:29 PM

- From the *Admin* screen, select one of the following buttons: **QAS**, **Quality Control**, or **Test Patterns**. All Quality Assurance and Quality Control Tasks can be accessed this way at any time.

Admin

Operators: Manage Operators, My Settings

Procedures: Procedure Editor, Procedure Order, View Editor, QAS

Quality Control: Quality Control, QC Report, Test Patterns, Reject And Repeat Report

System: System Tools, System Defaults, System Diagnostics, Preferences, About, Exposure Report, Biopsy Devices

Connectivity: Query Retrieve, Import, Manage Output Groups, Incoming Log, Archive

Manager, Tech (Manager) 5:36:11 PM

12.1 Recommended Tests

The following tests are recommended for optimal performance and to make sure that the system is correctly aligned. Refer to the guidelines given in the *1999 ACR Stereotactic Breast Biopsy Quality Control Manual* for the procedures as needed.

Table 14: Recommended Tests

Test	Frequency
QAS Test	Daily - before clinical use
Gain Calibration	Weekly
Phantom Image Quality Test*	Weekly
Hardcopy Output Quality Test	Monthly
Visual Equipment Check	Monthly
Geometry Calibration	Semi-annually
Compression	Semi-annually
Repeat Analysis	Semi-annually
*The signal value should remain within $\pm 10\%$ of the signal obtained for the 4 cm phantom, assuming the signal level for a 4 cm phantom is appropriate.	

12.2 QAS Test

Each day that the system is used, do this test one time to confirm the system accuracy. Record the results in the [QAS Test Checklist](#) on page 127.

1. Select the **Admin** button on the Acquisition Workstation Control monitor, then select the **QAS** button from the *Admin* screen.



Figure 70: Admin Screen

2. When the QAS screen shows on the Acquisition Workstation, select the **Biopsy** tab.
3. Make sure that QAS appears in the Device field.

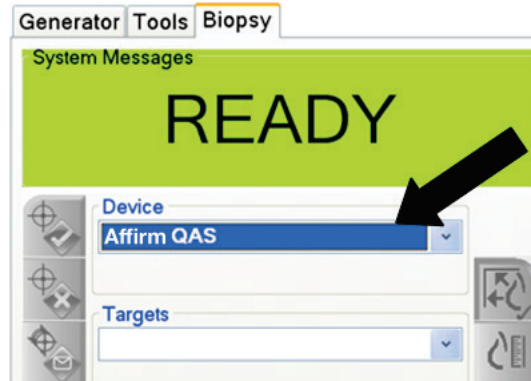

Figure 71: Device Field in the Biopsy Tab

4. Remove the Compression Paddle.

5. Attach the QAS Phantom. (If the QAS Phantom uses a needle, fully extend the needle.)
6. Press and hold a right or left **Motor Enable** button pair on the Biopsy Control Module. The QAS Phantom moves automatically to pre-programmed X and Y positions.
7. Turn the Biopsy Device Knob to show 0.0 on the Differential line in all three columns of the Biopsy Control Module.
8. Select Manual exposure mode, 25 kV, 30 mAs, silver filter in the QAS screen. (If the QAS Phantom uses a needle, select the Manual exposure mode, 25 kV, 10 mAs, silver filter in the QAS screen.)
9. Acquire and accept an image for the first view in the procedure. Note that the Auto-Accept feature is not enabled during the QAS procedure, and that targeting on the QAS Phantom occurs automatically.
10. Select the **Create Target** button to send the target to the Biopsy Control Module. Verify that the target coordinates are within ± 1 mm of X, Y, and Z numbers on the current line of the Biopsy Control Module.



Warning:

If the targeting coordinates are not within ± 1 mm, contact Technical Support. Do not try to adjust the system. Do not perform any biopsy procedure with the Affirm system until Technical Support indicates the system is ready for use.



Warning:

The user or a Service Engineer must correct problems before the system is used.

11. Repeat steps 8 and 9 for all unexposed views.
12. At the Acquisition Workstation, select the **End QC** button.
13. At the Biopsy Control Module, press a **Home Position** button (Left or Right) to move the QAS Phantom to the side.
14. Remove the QAS Phantom.

12.3 Gain Calibration

1. Select the **Admin** button on the Acquisition Workstation Control monitor, then select the **Quality Control** button from the *Admin* screen.

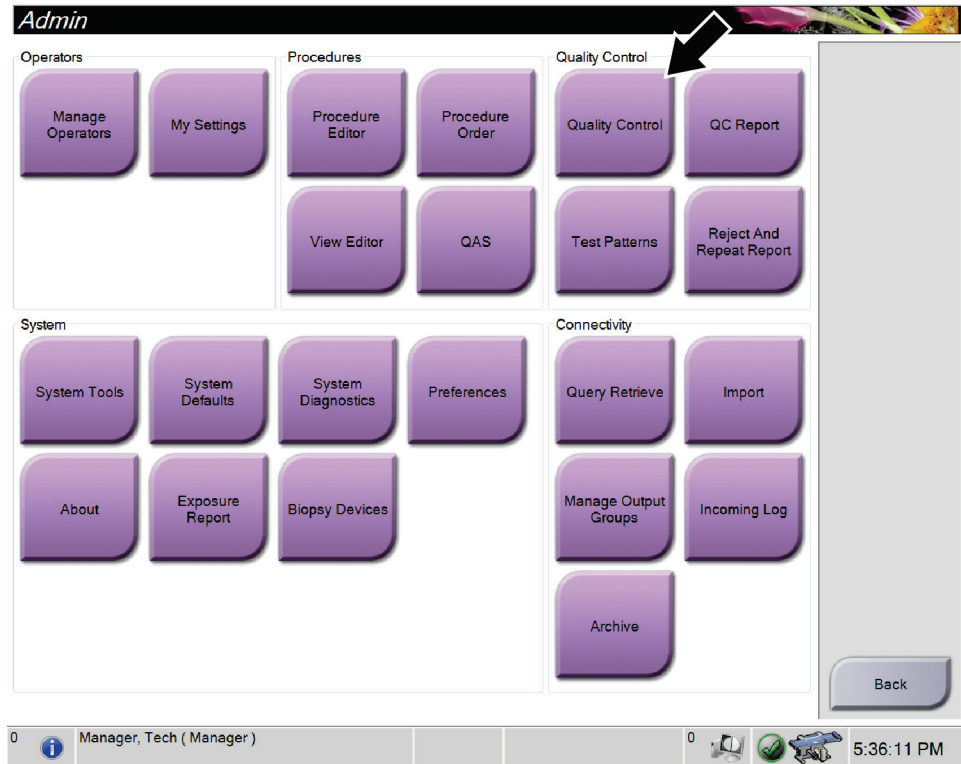

Figure 72: Admin Screen

2. Position the Gain Calibration Device.
3. Select the **Start** button.
4. Follow the instructions on the *Info* dialog box, then select **OK**.
5. When the System Message shows "**Ready**", press and hold the **X-ray** button to take an exposure. Release the button when the tone stops and the System Message shows "**Standby**".
6. Select **Accept**.
7. Repeat steps 5 and 6 for all unexposed views.
8. When the *Successfully Completed* dialog box appears, select **OK**.
9. Select **End Calibration**.

12.4 Geometry Calibration



Note

It is important to clean the Geometry Calibration paddle and the surface of the digital image receptor before starting the calibration procedure.

1. Select the **Admin** button on the Acquisition Workstation Control monitor, then select the **Quality Control** button from the *Admin* screen.



Figure 73: Admin Screen

2. Position the Geometry Calibration Paddle.
3. Select the **Start** button.
4. Follow the instructions on the *Info* dialog box, then select **OK**.
5. When the System Message shows "**Ready**", press and hold the **X-ray** button to take an exposure. Release the button when the tone stops and the System Message shows "**Standby**".
6. Select **Accept**.
7. Repeat steps 5 and 6 for all unexposed views.
8. When the *Successfully Completed* dialog box appears, select **OK**.
9. Select **End Calibration**.

Chapter 13 Care and Cleaning

13.1 Cleaning

13.1.1 General Information About Cleaning

Before each examination, clean and use a disinfectant on any part of the system which touches a patient. Give the attention to the paddles and the image receptor.



Caution:

Do not use any hot source (like a heating pad) on the image receptor.

Be careful with the compression paddles. Inspect the paddles. Replace the paddle when you see damage.

13.1.2 For General Cleaning

Use a lint-free cloth or pad and apply a diluted dishwashing liquid.



Caution:

Use the least possible amount of cleaning fluids. The fluids must not flow or run.

If more than soap and water is required, Hologic recommends any one of the following:

- 10% chlorine bleach and water with one part commercially available chlorine bleach (normally 5.25% chlorine and 94.75% water) and nine parts water
- Commercially available isopropyl alcohol solution (70% isopropyl alcohol by volume, not diluted)
- 3% maximum concentration of hydrogen peroxide solution

After you apply any of the above solutions, use a pad and apply a diluted dishwashing liquid to clean any parts which touch the patient.



Warning:

If a paddle touches possible infectious materials, contact your Infection Control Representative to remove contamination from the paddle.



Caution:

To prevent damage to the electronic components, do not use disinfectant sprays on the system.

13.1.3 How to Clean the Biopsy Control Module Screen

There are many commercially available products to clean LCD screens. Make sure the product that you select is free of strong chemicals, abrasives, bleach, and detergents that contain fluorides, ammonia, and alcohol. Follow the directions of the manufacturer of the product.

13.1.4 To Prevent Possible Injury or Equipment Damage

Do not use a corrosive solvent, abrasive detergent, or polish. Select a cleaning/disinfecting agent that does not damage the plastics, aluminum, or carbon fiber.

Do not use strong detergents, abrasive cleaners, high alcohol concentration, or methanol at any concentration.

Do not expose equipment parts to steam or high temperature sterilization.

Do not let liquids enter the internal parts of the equipment. Do not apply cleaning sprays or liquids to the equipment. Always use a clean cloth and apply the spray or liquid to the cloth. If liquid enters the system, disconnect the electrical supply and examine the system before returning it to use.



Caution:

Wrong cleaning methods can damage the equipment, decrease imaging performance, or increase the risk of electric shock.

Always follow instructions from the manufacturer of the product you use for cleaning. The instructions include the directions and precautions for the application and contact time, storage, wash requirements, protective clothing, shelf life, and disposal. Follow the instructions and use the product in the most safe and effective method.

13.2 Preventive Maintenance Schedule

Table 15: Operator Preventive Maintenance Schedule

Maintenance Task Description	Each use	Daily	Weekly	Semiannually
Clean the Biopsy Paddle with a disinfectant after use.*	x			
Clean the Breast Platform with a disinfectant after use.*	x			
Inspect the Biopsy Paddle for damage before use.	x			
Inspect the calibration Phantom for damage.	x			
Inspect all cables for wear and damage before use.	x			
Make sure that the Needle Guides are installed correctly before use.	x			
Make sure that all displays are illuminated.	x			
Make sure that all locks and controls function and move smoothly.		x		
Make sure that all lights and their switches function.		x		
Perform Gain Calibration procedures.		x		
Perform QAS Procedures before use of the system.		x		
Inspect the overall integrity of the system for loose or missing hardware or components and signs of damage.			x	
Geometry Calibration (refer to Geometry Calibration on page 108)				x
Make sure that all labels are readable and properly affixed.				x
*Contact Technical Support for the current list of recommended cleaning solutions.				



Note

The Preventive Maintenance Schedule for the Service Engineer is in the Service Manual.

Appendix A System Specifications

A.1 Product Measurements

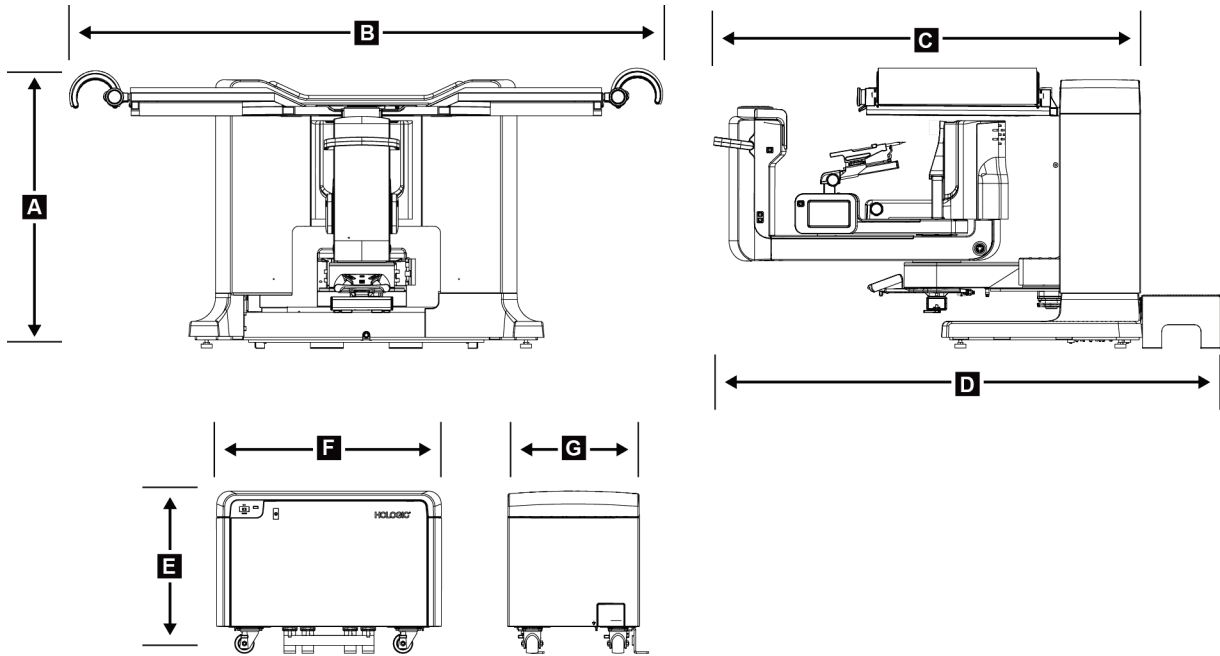

Figure 74: Gantry and Generator Dimensions

Gantry/Patient Platform Dimensions

A.	Height	107 cm (42 inches)
B.	Width	229 cm (90 inches)
C.	Depth with C-arm	178 cm (70 inches)
D.	Overall Depth	198 cm (78 inches)
	Total Weight	445 kg (980 pounds)

Generator Dimensions

E.	Height	63 cm (25 inches)
F.	Width	87 cm (34 inches)
G.	Depth	55 cm (22 inches)
	Weight	136 kg (300 pounds)

Affirm Prone Biopsy System User Guide

Appendix A: System Specifications

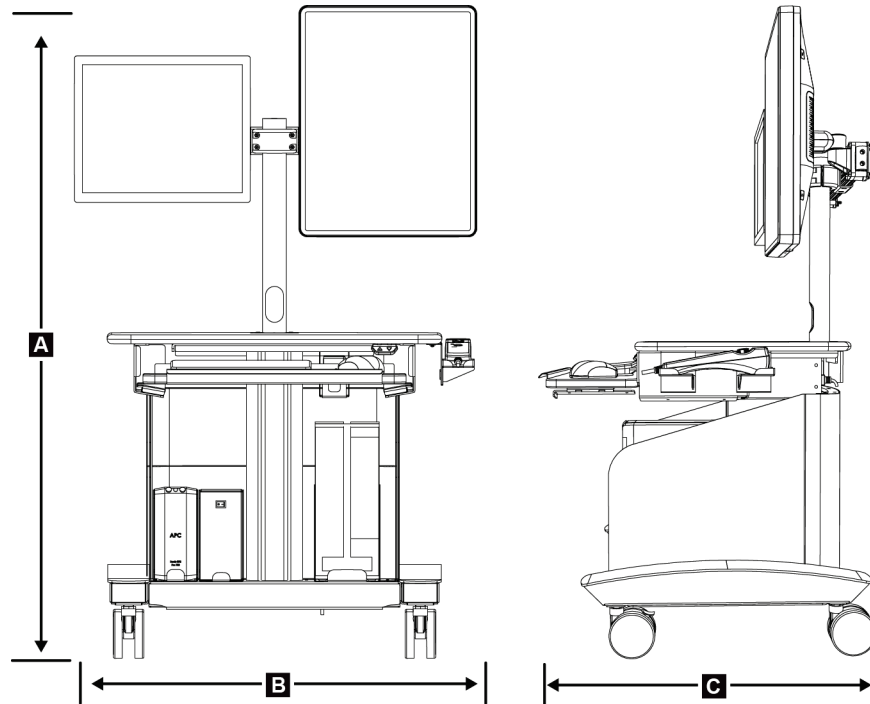

Figure 75: Acquisition Workstation Dimensions

Acquisition Workstation Dimensions

A.	Height	138.4 cm (54.5 inches)
	Overall Height Range	138.4 cm (54.5 inches) to 179.1 cm (70.5 inches)
	Height Range (floor to work surface)	71.1 cm (28 inches) to 111.8 cm (44 inches)
B.	Width	85.4 cm (34 inches)
C.	Depth	75.1 cm (30 inches)
	Total Weight	114 kg (252 pounds)

A.2 Operation and Storage Environment

A.2.1 General Conditions for Operation

Temperature Range	10°C to 30°C
Relative Humidity Range	10% to 80%, non-condensing
Atmospheric Pressure	697hPa - 1060hPa

A.2.2 General Conditions for Transport and Storage

Temperature Range	10°C to 35°C
Relative Humidity Range	10 to 80%, not packaged for outdoor storage

A.3 Electrical Input

A.3.1 Generator/Gantry

<i>Mains Voltage</i>	200/208/220/230/ 240 VAC ±10%
<i>Mains Impedance</i>	Maximum line impedance not to exceed 0.20 ohms for 208/220/230/240 VAC, 0.16 ohms for 200 VAC
<i>Mains Frequency</i>	50/60 Hz ±5%
<i>Average Current over 24 Hours</i>	< 5 A
<i>Peak Line Current</i>	4 A (65 A maximum for < 5 seconds)

A.3.2 Acquisition Workstation

<i>Mains Voltage</i>	100/120/200/208/220/230/240 VAC ±10%
<i>Mains Frequency</i>	50/60 Hz ±5%
<i>Power Consumption</i>	< 1000 watts
<i>Duty Cycle</i>	13.3% ~ 8 minutes per hour or 2 minutes on, 13 minutes off
<i>Peak Line Current</i>	2.5 A

A.4 Gantry Technical Information

A.4.1 C-arm

<i>Rotation Range</i>	180°
<i>Source-to-Image Distance (SID)</i>	80 cm
<i>Stereo Range</i>	±15°
<i>Tomosynthesis Range</i>	±7.5°

A.4.2 Compression System

<i>Manual Compression Force</i>	300 N (67.4 lb) maximum
<i>Motorized Compression Force</i>	62.3 N (14.0 lb) minimum 200 N (45.0 lb) maximum

A.4.3 Biopsy Guidance Module

<i>Accuracy of Biopsy Arm Controller</i>	maximum deviation: 1 mm in either direction of target coordinate
<i>Combined Accuracy of Biopsy Guidance Module and Biopsy Device</i>	maximum deviation: 2 mm in either direction of target coordinate

A.4.4 X-ray Tube

<i>Focal Spot</i>	<i>Large (0.3 mm) Nominal</i>
<i>Tube Voltage</i>	<i>20-49 kVp in 1 kVp increments</i>
<i>Anode Material</i>	<i>Tungsten</i>
<i>X-ray Window</i>	<i>0.63 mm Beryllium</i>
<i>Reference Angle</i> <i>(angle of the reference axis to the plane of the image reception area)</i>	<i>90°</i>

A.4.5 X-ray Beam Filtration and Output

<i>Filtration</i>	<i>Aluminum, 0.70 mm (nominal)</i> <i>Silver, 0.050 mm ±10%</i>
-------------------	--

kV/mA Range

Table 16: Maximum mA as a Function of kV

kV	LFS mA	kV	LFS mA
20	100	35	200
21	110	36	190
22	110	37	180
23	120	38	180
24	130	39	180
25	130	40	170
26	140	41	170
27	150	42	160
28	160	43	160
29	160	44	150
30	170	45	150
31	180	46	150
32	190	47	140
33	200	48	140
34	200	49	140

A.4.6 X-ray Generator

<i>Type</i>	<i>Constant potential, three-phase, high frequency inverter</i>
<i>Rating</i>	<i>7.0 kW (large focus) maximum, mid focus 4.08 KW(120 mA at 34kV)</i>
<i>Electrical Power Capacity</i>	<i>9.0 kW maximum</i>
<i>kV Range</i>	<i>20-49 kVp in 1 kVp increments</i>
<i>mA Range</i>	<i>10-200 mA</i>
<i>mAs Accuracy</i>	<i>±(10% + 0.2 mAs)</i>
<i>mAs Range</i>	<i>3-500 mAs, 45 steps: 3.2, 3.6, 4, 4.5, 5, 5.6, 6.3, 7.1, 8, 9, 10, 11, 12.5, 14, 16, 18, 20, 22, 25, 28, 32, 36, 40, 45, 50, 56, 63, 71, 80, 90, 100, 110, 125, 140, 160, 180, 200, 220, 250, 280, 320, 360, 400, 450, 500 mAs</i>

A.4.7 Image Receptor Technical Information

<i>Dimensions</i>	
<i>Height</i>	<i>33 cm (13 inches)</i>
<i>Width</i>	<i>21.5 cm (8.46 inches)</i>
<i>Depth</i>	<i>10 cm (3.94 inches)</i>
<i>Weight</i>	<i>7.3 kg (16 pounds)</i>
<i>Actual Image Area</i>	<i>14.3 cm x 12.5 cm</i>
<i>Image Device</i>	<i>Direct conversion amorphous Selenium coated TFT array</i>
<i>Pixel Count</i>	<i>2048 (H) x 1792 (V)</i>
<i>Pixel Size</i>	<i>70 μm (H) x 70 μm (V)</i>
<i>Digitizing Resolution</i>	<i>14 bit data</i>
<i>Detective Quantum Efficiency (DQE)</i>	<i>Not less than 50% at 0.2 lp/mm (stereotactic mode)</i> <i>Not less than 30% at 0.2 lp/mm (tomosynthesis mode)</i> <i>Not less than 15% at 7.1 lp/mm (stereotactic and tomosynthesis modes)</i>
<i>Modulation Transfer Function (MTF)</i>	<i>Not less than 40% at 7.1 lp/mm</i>
<i>Synchronization</i>	<i>Interlocked with x-ray control signal</i>

A.5 Acquisition Workstation Technical Information

A.5.1 Network Environment

<i>Network Interface</i>	<i>100/1000 BASE-T Ethernet</i>
--------------------------	---------------------------------

A.5.2 Acquisition Workstation Cart

<i>Monitor Arm Weight Rating</i>	<i>11.3 kg (25 pounds)</i>
----------------------------------	----------------------------

Appendix B System Messages and Alerts

B.1 Error Recovery and Troubleshooting

Most faults and alert messages are cleared without result to your workflow. Follow the instructions on the screen or fix the condition then clear the status from the Taskbar. Some conditions require a system restart or indicate that more action is necessary (for example, to call Hologic Technical Support). This appendix describes the message categories and your actions to return the system to normal operation. If errors repeat, contact Hologic Technical Support.

B.2 Types of Messages

B.2.1 Fault Levels

Each Message has a particular set of the following characteristics:

- Aborts an exposure in progress (yes/no)
- Prevents an exposure from starting (yes/no)
- Displays a message to the user on the Acquisition Workstation (yes/no)
- May be reset by the user (yes/no)
- May be reset automatically by the system. (yes/no)

Displayed Messages

All displayed messages will be shown in the user's selected language.

Any message which aborts an exposure or prevents an exposure from starting will always display a message directing the user's actions required to proceed.

Additional Message Information

Technical information about the message is available in the log file.

Some messages always show as a critical fault (a system restart is necessary). These messages result from a condition which prevents an exposure, and which cannot be reset by the user or the system.

B.2.2 System Messages

When the following system messages show, do the step shown in the User Action column to clear the message and allow the next exposure.

Table 17: System Messages











Icon	Message	User Action
	Waiting for Detector	No action needed.
	Invalid detector calibration	Install the gain paddle and perform Gain Calibration.
	Invalid geometry calibration	Install the geometry paddle and perform Geometry Calibration.
	Invalid use of compression paddle	Install the correct paddle.
	Configuration file is missing	[Applies to Service Personnel.]
	An E-Stop has been pressed	Turn the Emergency Off switch one-quarter turn to reset the switch.
	Tube needs to be manually positioned (move to -15 degrees)	Manually rotate the C-arm to -15 degrees.
	Tube needs to be manually positioned (move to 15 degrees)	Manually rotate the C-arm to +15 degrees.
	Tube needs to be manually positioned (move to 0 degrees)	Manually rotate the C-arm to 0 degrees.

Table 17: System Messages

Icon	Message	User Action
	Needle must be moved for Biopsy	Move the needle to the correct location.
	Compression less than 0.5 cm not allowed	Move the Compression Paddle to greater than 0.5 cm.

B.3 UPS Messages

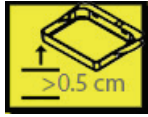

Note

The User Guide for the UPS is supplied with the system. Refer to the *UPS User's Guide* for complete instructions.

The LCD Display Interface in the Uninterruptible Power Supply (UPS) shows the status of various utility and battery backup conditions.

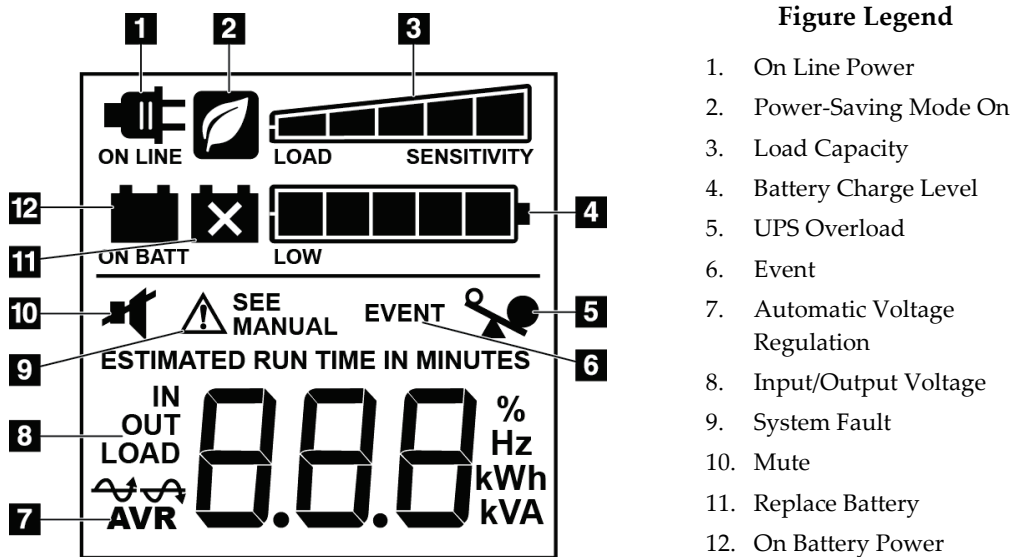

Figure 76: UPS LCD Display

If the UPS battery expires, the Replace Battery icon shows. Contact your service representative to replace the battery.



Appendix C Dose Information

C.1 AEC Technique Tables

Table 18: AEC Table - Standard Dose

Step	Thickness (mm)	AutokV Mode				mAs Multiplier *100	kV Switching		Scout mAs
		kV	Filter Type	mAs Ref1	mAs Ref2		a *100	b *100	
0	0	25	Ag	33	33	94	83	120	5
1	5	25	Ag	33	39	94	83	120	5
2	10	25	Ag	39	50	78	83	140	5
3	15	25	Ag	50	66	73	84	150	5
4	20	25	Ag	66	86	71	84	170	5
5	25	26	Ag	70	88	79	86	160	5
6	30	26	Ag	88	117	77	86	190	5
7	35	27	Ag	99	126	87	88	190	5
8	40	28	Ag	110	147	94	88	290	5
9	45	28	Ag	147	199	100	88	370	5
10	50	28	Ag	199	256	108	88	530	10
11	55	29	Ag	226	285	119	87	820	10
12	60	30	Ag	255	314	130	86	1080	10
13	65	31	Ag	283	355	139	86	1430	10
14	70	32	Ag	322	371	154	87	750	10
15	75	33	Ag	339	393	160	88	900	10
16	80	34	Ag	361	430	171	87	1120	10
17	85	35	Ag	395	476	192	87	1340	10
18	90	36	Ag	439	465	221	87	1650	10
19	95	37	Ag	432	456	223	87	1450	10
20	100	38	Ag	425	448	223	87	1580	10
21	105	39	Ag	418	412	226	88	1310	10
22	110	39	Ag	412	429	188	88	1380	10
23	115	39	Ag	429	444	166	88	1320	10
24	120	39	Ag	444	432	146	89	100	10
25	125	39	Ag	432	446	120	89	1240	10
26	130	39	Ag	446	459	106	89	1280	10
27	135	39	Ag	459	446	93	89	1310	10
28	140	39	Ag	446	451	77	89	1340	10
29	145	39	Ag	451	431	66	89	1370	10
30	150	39	Ag	431	444	54	89	1390	10
31	155	39	Ag	444	457	48	89	1420	10

Appendix D Hologic Biopsy Devices

D.1 Hologic Factory-Verified Biopsy Devices

Table 19: Hologic Factory-Verified Biopsy Devices

Manufacturer	Description	Model
Hologic	Affirm QAS Needle	ASY-03949
Hologic	ATEC® 9 g x 12 cm, 12 mm (Petite)	ATEC 0912-12
Hologic	ATEC 9 g x 12 cm, 20 mm	ATEC 0912-20
Hologic	ATEC 12 g x 12 cm, 20 mm	ATEC 1212-20
Hologic	ATEC 9 g x 9 cm, 12 mm (Petite)	ATEC 0909-12
Hologic	ATEC 9 g x 9 cm, 20 mm	ATEC 0909-20
Hologic	ATEC 12 g x 9 cm, 20 mm	ATEC 1209-20
Hologic	ATEC 9 g x 14 cm, 20 mm	ATEC 0914-20
Hologic	Eviva® 9 g x 13 cm, 12 mm (Blunt Petite)	Eviva 0913-12
Hologic	Eviva 9 g x 13 cm, 12 mm (Trocar Petite)	Eviva 0913-12T
Hologic	Eviva 9 g x 13 cm, 20 mm	Eviva 0913-20
Hologic	Eviva 12 g x 13 cm, 20 mm	Eviva 1213-20
Hologic	Eviva 9 g x 10 cm, 12 mm (Blunt Petite)	Eviva 0910-12
Hologic	Eviva 9 g x 10 cm, 12 mm (Trocar Petite)	Eviva 0910-12T
Hologic	Eviva 9 g x 10 cm, 20 mm	Eviva 0910-20
Hologic	Eviva 12 g x 10 cm, 20 mm	Eviva 1210-20

Appendix E Forms

E.1 QAS Test Checklist

Date	Tech	X Diff	Y Diff	Z Diff	Pass/Fail

Glossary of Terms

ACR

American College of Radiology

AEC

Automatic Exposure Control

Annotations

Graphic or text marks on an image to indicate an area of interest.

BCM

Biopsy Control Module

Collimator

A device at the x-ray tube to control the x-ray beam exposure area.

DICOM

Digital Imaging and Communications in Medicine

EMC

Electromagnetic Compatibility

Image Receptor

Assembly of the x-ray detector and carbon fiber cover.

Lateral Needle Approach

Biopsy device approach that is parallel to the imaging plane and perpendicular to the plane of compression.

LUT

Look Up Table. A list of settings to apply to other vendor images for optimal viewing.

MQSA

Mammography Quality Standards Act

RF

Radio Frequency

ROI

Region of Interest

SID

Source to Image Distance

Standard Needle Approach

Biopsy device approach that is parallel to the plane of compression and perpendicular to the imaging plane.

Stereo Pair

The stereotactic image pair acquired from the $\pm 15^\circ$ projections.

Stroke

Excursion of needle when the biopsy instrument is fired. The Stroke is entered into the system and depends on the instrument used. Each instrument has a specified stroke.

Stroke Margin

The safety margin (in mm) which remains between the fired needle position and the breast platform. This margin is calculated by the system according to the "Z" coordinate, the Stroke, and the compression amount.

Tomosynthesis

An imaging procedure which combines a number of projections taken at different angles. The tomosynthesis images can be reconstructed to show focal planes (slices) within the object.

UDI

Unique Device Identifier

UPS

Uninterruptible Power Supply

Affirm Prone Biopsy System User Guide

Glossary of Terms

X-axis

Refers to the horizontal plane across the biopsy window. When the Needle Guidance Stage moves left of the reference point, the movement in the X direction is negative. When the stage moves right of the reference point (from the point of view of the patient), the movement is positive.

Y-axis

Refers to the vertical plane directly above the biopsy window. When the Needle Guidance Stage moves away from the reference hole (from the point of view of the chest wall edge of the biopsy paddle), the Y direction movement increases in value. When the Stage moves toward the reference hole, Y decreases in value.

Z-axis

Refers to the depth through the biopsy window. The value of Z increases as the Stage moves toward the breast platform, and decreases as the stage moves away from the platform.

Index

A

about screen - 77
 access
 about screen - 77
 system tools - 80
 accessories - 87
 biopsy devices - 92
 maximum comfort package - 87
 needle guide - 93
 paddles - 90
 acquisition workstation
 cart, monitor arm weight rating - 117
 cart, weight rating - 117
 controls - locations illustrated - 24
 work surface of Acquisition Workstation -
 location illustrated - 24
 alerts and messages, system - 119, 120, 121
 aperture, installing to Patient Platform - 87
 Archive function of Admin screen, described - 84
 arm support, locking into position - 87
 Arm Through Maximum Comfort Package,
 accessories, installation - 87

B

Biopsy Arm
 biopsy arm controls - 21, 49
 biopsy device holder, installing - 92
 motor enable button - location illustrated - 20
 biopsy devices - 92
 install a biopsy device - 94
 install a biopsy device holder - 92
 installed, where to find a list of - 81

C

capabilities of Affirm system - 2
 c-arm
 c-arm controls - 20, 22
 dimensions/measurements - 113
 movement, functional tests - 27
 overview - illustrated - 6
 Tubehead technical specs - 115
 Cautions, Warnings, and Notes - definition of - 4

circuit breaker of Generator - location illustrated -
 19
 cleaning - 109
 general cleaning - 109
 preventing possible injury or equipment
 damage - 110
 close a procedure - 41
 complaints, product - 4
 compliance - 11
 compliance requirements - 11
 labels and locations - 16
 compression
 functional tests - 27
 Compression Apply/Release buttons - illustrated
 on Footswitch - 22
 conditions
 general conditions for operation - 114
 general conditions for transport and storage -
 114
 configuration information of system, where to find
 it in About screen - 77
 contraindications - 1
 Control Display Monitor of Acquisition
 Workstation (AWS)
 location illustrated - 24
 control handle controls - 22
 Control Handle of Support Arm
 buttons illustrated and described - 22
 location illustrated - 20
 controls and indicators - 19
 acquisition workstation controls - 24
 biopsy arm controls - 21, 49
 c-arm controls - 20, 22
 control handle controls - 22
 emergency off switches - 11
 patient platform controls - 23
 system power controls - 19
 cushions, head, wedge, and hip - 87
 cybersecurity - 4

D

download, images - 81
 DVD/CD drive of Acquisition Workstation -
 location illustrated - 24

E

edit

- edit a view - 40
- edit patient information - 34

electrical input - 115

emergency off switches - 11

- emergency OFF switches (E-Stop) of C-arm -
locations illustrated - 20
- emergency OFF switches (E-Stop) throughout
entire system - description - 11
- emergency OFF/X-ray Activation (E-Stop)
handheld remote of Acquisition
Workstation - location illustrated - 24

environment - 114

- general conditions for operation - 114
- general conditions for transport and storage -
114

error recovery and troubleshooting, about such messages - 119

F

footrest, adjusting - 87

functional tests - 27, 28

- C-arm Up/Down movement - 27
- Compression Apply/Release - 27
- Patient Platform - 28

G

Gantry

- dimensions/measurements - 113

Generator

- dimensions/measurements - 113

H

height, full (Up limit) button for Patient Platform (location illustrated) - 23

holder of a biopsy device, installing - 92

I

Image Display Monitor of Acquisition Workstation (AWS)

- location illustrated - 24

images

creating - 81

image, downloading - 81

remote access to - 81

indications for use - 1

install

- install a biopsy device - 94
- install a biopsy device holder - 92
- install a paddle - 91

installation instructions - 3

Institution tab of About screen, description - 77

intended use - 1

interlocks - 11

Isolation Transformer Power Switch of AWS - location illustrated - 19, 24

K

knobs

- manual advance/retract, of Biopsy Device
Needle - locations illustrated - 20
- manual compression adjust, of Breast Platform
of Compression Arm - locations
illustrated - 20

L

labels and locations - 16

licenses, installed, list of - 81

Licensing tab of About screen, description - 77

lock, system - illustrated on Control Handle - 22

locks - interlocks - 11

log in - 26

M

maintenance - See cleaning

Manager, Radiological Technologist, Service Tools functions described - 81

Maximum Comfort Package, installation and use - 87

messages

- additional information - 119
- Uninterruptible Power Supply (UPS) - 121

N

- needle guide - 93
- network interface environment specifications for Acquisition Workstation (AWS) - 117
- Notes, Warnings, and Cautions - definition of each - 4

O

- ON/OFF power
 - OFF - how to remove all power from system - 28
 - OFF switches - emergency (E-Stop) - description - 11
 - ON/OFF power controls throughout system - locations illustrated - 19
 - ON/Reset button of computer - location illustrated - 19
- open a procedure - 33

P

- paddles - 90
 - different sizes - illustrated - 90
 - how to install or remove - 91
- patient
 - edit patient information - 34
 - select patient screen - 32
- patient arm through, accessories - 87
- Patient Platform
 - Patient Platform controls throughout system - locations illustrated - 23
 - Patient Platform Up/Down controls on Control Handle - 22
 - Patient Platform, dimensions/measurements - 113
 - Patient Platform, functional tests - 28
- power
 - remove all power - 28
 - shut down the system - 28
 - start the system - 25
 - system power controls - 19
- power controls - locations illustrated - 19
- procedures
 - close a procedure - 41
 - open a procedure - 33

- product dimensions/measurements - 113

Q

- quality control tasks - 29

R

- Radiological Technologist Manager, Service Tools
 - functions described - 81
- release level of system, where to find it - 77
- remote access to image reports - 81
- remove all power - 28
- report
 - image report
 - creating - 81
 - remote access to - 81

S

- safety information
 - emergency off switches - 11
 - interlocks - 11
 - warnings and cautions - 7, 11
- screens
 - about screen - 77
 - select patient screen - 32
- select patient screen - 32
- shut down the system - 28
- software version numbers, where to find them - 81
- specifications
 - C-arm/Tubehead technical information - 115
 - electrical input specifications for Generator/Gantry and Acquisition Workstation (AWS) - 115
 - operating environment general conditions - 114
 - product dimensions/measurements - 113
 - transport and storage environment general conditions - 114
- start the system - 25
- storage environment - 114
- symbols - 14
- system - 119, 120, 121
 - log in - 26
 - management troubleshooting - 81
 - power controls - locations illustrated - 19
 - remove all power - 28

- shut down the system - 28
- start the system - 25
- symbols - 14
- system administration - 77
- system capabilities - 2
- system configuration information, where to find it in About screen - 77
- System Lock button - illustrated on Control Handle - 22
- system overview - 5
- system specifications - 113
- System tab of About screen, description - 77
- system tools - 80
- System Tools, onscreen, how to access - 80

T

- task lighting
 - on Patient Platform - locations illustrated - 23
 - ON/OFF button on Tubehead/Tube Arm Mechanism - location illustrated - 20
- technical specifications - 115
- technical support - 4
- Technologist Radiological, Manager, Service Tools
 - functions described - 81
- tests
 - functional, C-arm Up/Down movement - 27
 - functional, Compression Apply/Release - 27
 - functional, Patient Platform - 28
- tools
 - system tools - 80
- touchscreen display - locations illustrated - 20
- training requirements - 3
- transport and storage environment general conditions - 114
- troubleshooting and error recovery, about such messages - 119

U

- Uninterruptible Power Supply
 - Uninterruptible Power Supply (UPS)
 - Power/Reset Button of AWS - location illustrated - 19, 24
 - Uninterruptible Power Supply (UPS), status readings/messages, illustrated - 121

- Uninterruptible Power Supply (UPS), what to do when Replace Battery icon is displayed - 121
- Unique Device Identifier (UDI) tab of About screen, description - 77
- user interface - 29, 49
 - biopsy control module - 49
 - control display - 29
 - system administration - 77
- user profile - 2

V

- version level of system, where to find it - 77
- view
 - edit a view - 40

W

- warnings and cautions - 7, 11
- Warnings, Cautions, and Notes - definition of each - 4
- warranty - 3
- weight limit for patient - 1
- workstation
 - cart, monitor arm weight rating - 117
 - cart, weight rating - 117
 - controls - locations illustrated - 24
 - work surface of Acquisition Workstation - location illustrated - 24

X

- x-ray
 - X-ray beam filtration and output specifications - 116
 - X-ray Generator specifications - 117
 - x-ray tube technical specifications - 116

HOLOGIC®



Hologic Inc.
36 Apple Ridge Road
Danbury, CT 06810 USA



Hologic Ltd.
Heron House Oaks Business Park
Crewe Road
Wythenshawe, Manchester
M23 9HZ, UK
Tel: +44 (0)161 946 2206

CE
0044