

SELENIA®  
Dimensions®



**User Guide**

MAN-05757-002 Revision 001

**HOLOGIC®**



# **Selenia<sup>®</sup> Dimensions<sup>®</sup>**

Digital Mammography System

Digital Tomosynthesis System

## **User Guide**

For Software Version 1.10

Part Number MAN-05757-002

Revision 001

December 2018

**HOLOGIC<sup>®</sup>**

## **Technical Support**

USA: +1.877.371.4372

Europe: +32 2 711 4690

Asia: +852 37487700

Australia: +1 800 264 073

All Other: +1 781 999 7750

Email: [BreastHealth.Support@hologic.com](mailto:BreastHealth.Support@hologic.com)

© 2018 Hologic, Inc. Printed in the USA. This manual was originally written in English.

Hologic, 3D, 3D Mammography, Affirm, C-View, Dimensions, FAST Paddle, Genius, I-View, ImageChecker, Quantra, Selenia, SmartCurve, and associated logos are trademarks and/or registered trademarks of Hologic, Inc., and/or its subsidiaries in the United States and/or other countries. All other trademarks, registered trademarks, and product names are the property of their respective owners.

This product may be protected by one or more U.S. or foreign patents as identified at [www.Hologic.com/patents](http://www.Hologic.com/patents).

# Table of Contents

List of Figures .....	xi
-----------------------	----

List of Tables .....	xv
----------------------	----

## 1: Introduction 1

1.1 Intended Use.....	1
1.1.1 Contraindications .....	1
1.2 Potential Adverse Effects of Mammography Systems on Health .....	2
1.3 System Capabilities.....	2
1.4 About the Genius 3D Mammography Exam .....	2
1.5 More Information About Tomosynthesis.....	3
1.6 About C-View and Intelligent 2D.....	4
1.6.1 C-View and Intelligent 2D Software .....	4
1.6.2 C-View and Intelligent 2D Warnings .....	5
1.6.3 C-View and Intelligent 2D Theory of Operation.....	5
1.7 User Profiles.....	6
1.7.1 Mammography Technologist.....	6
1.7.2 Radiologist.....	6
1.7.3 Medical Physicist.....	6
1.8 Training Requirements.....	7
1.9 Quality Control Requirements.....	7
1.10 Where to Find the Installation Instructions.....	7
1.11 Where to Find Technical Description Information.....	7
1.12 Warranty Statement.....	8
1.13 Technical Support .....	8
1.14 Product Complaints.....	8
1.15 Hologic Cybersecurity Statement.....	8
1.16 Symbols .....	9
1.17 Descriptions of Warnings, Cautions, and Notes .....	10
1.18 Document Conventions .....	10

## 2: General Information 11

2.1 System Overview .....	11
2.1.1 Tubestand Overview .....	11
2.1.2 C-Arm Overview .....	12
2.1.3 Acquisition Workstation Overview .....	13
2.2 Safety Information .....	14
2.3 Warnings and Precautions.....	14
2.4 Emergency Off Switches .....	19
2.5 Interlocks.....	19

# Selenia Dimensions System User Guide

## Table of Contents

---

2.6	Compliance .....	20
2.6.1	Compliance Requirements .....	20
2.6.2	Compliance Statements.....	21
2.7	Label Locations.....	23
<b>3: System Controls and Indicators</b> .....		<b>25</b>
3.1	System Power Controls .....	25
3.2	Tubestand Controls and Indicators .....	26
3.2.1	Tubehead Display .....	27
3.2.2	Compression Device Controls and Display .....	27
3.2.3	C-Arm Control Panels.....	28
3.2.4	Dual Function Footswitch .....	28
3.3	Acquisition Workstation Controls and Indicators.....	29
3.3.1	Universal Acquisition Workstation Controls and Displays.....	29
3.3.2	Premium Acquisition Workstation Controls and Displays .....	30
3.3.3	Standard Acquisition Workstation Controls and Displays.....	31
3.3.4	Keyboard.....	32
3.3.5	Bar Code Scanner.....	32
3.3.6	Universal Acquisition Workstation Display .....	32
3.3.7	Premium Acquisition Workstation Touchscreen Display.....	32
3.3.8	Standard Acquisition Workstation Display .....	32
3.3.9	Image Display Monitor .....	32
<b>4: Startup, Functional Tests, and Shutdown</b> .....		<b>33</b>
4.1	How to Start the System.....	33
4.1.1	Preparation .....	33
4.1.2	Startup.....	33
4.1.3	Log In.....	36
4.2	Perform the Functional Tests.....	38
4.2.1	Compression Functional Tests .....	39
4.2.2	C-Arm Movement Functional Tests.....	40
4.3	Emergency Off Switches Functionality .....	47
4.4	How to Turn Off the System .....	48
4.5	How to Remove All Power from the System .....	48
<b>5: User Interface</b> .....		<b>49</b>
5.1	Select Function to Perform Screen .....	49
5.2	About the Taskbar.....	50
5.3	Select Patient Screen .....	52
5.3.1	About the Notices Tab .....	53
5.3.2	Open a Patient.....	54
5.3.3	Add a New Patient .....	54
5.3.4	Edit the Patient Information.....	54
5.3.5	Split the Patient Records.....	55
5.3.6	Delete a Patient .....	57

---

5.3.7	Filters for Patients.....	57
5.3.8	Refresh the Worklist.....	59
5.3.9	Query the Worklist.....	59
5.3.10	Admin.....	59
5.3.11	Log Out.....	59
5.3.12	Advanced Workflow Manager.....	60
5.4	Procedure Screen.....	60
5.4.1	How to Use the Implant Present Button.....	62
5.4.2	How to Use the Paddle Shift Feature.....	62
5.4.3	Procedure Information Dialog Box.....	63
5.4.4	Add a Procedure.....	65
5.4.5	Add (or Remove) a View.....	66
5.4.6	Edit a View.....	67
5.4.7	Retrieve.....	67
5.4.8	Close a Patient.....	68
5.5	How to Access the Image Review Features.....	68
5.6	Output Groups.....	69
5.6.1	Select an Output Group.....	69
5.6.2	Add or Edit an Output Group.....	69
5.6.3	Custom Output.....	70
5.7	On-Demand Outputs.....	71
5.7.1	Archive.....	71
5.7.2	Export.....	72
5.7.3	Print.....	73
<b>6: Images</b>		<b>75</b>
6.1	Image Display Screen.....	75
6.2	How to Set the Exposure Parameters.....	76
6.2.1	Select the Image Acquisition Mode (Tomosynthesis Option).....	76
6.2.2	Select the Exposure Mode.....	76
6.2.3	How to Use the AEC Sensor.....	76
6.3	How to Acquire an Image.....	77
6.3.1	Conventional Imaging Sequence of Events.....	78
6.3.2	Tomosynthesis Imaging Sequence of Events.....	78
6.3.3	How to Accept a Rejected Image.....	79
6.3.4	How to Accept or Reject a Pended Image.....	79
6.4	How to Correct and Reprocess Implant Images.....	79
6.4.1	If the Image Is Not Accepted.....	79
6.4.2	If the Image Is Accepted.....	79
6.5	How to Review the Images.....	80
6.5.1	Image Review Tools Tab.....	81
6.5.2	Notices Tab.....	82
6.5.3	Other Image Review Tools.....	83
6.5.4	Slice Indicator.....	84

---

# Selenia Dimensions System User Guide

## Table of Contents

---

6.6	How to Send the Images to the Output Devices.....	84
6.7	How to Use I-View 2D Contrast .....	85
6.7.1	How to Configure the Contrast Settings .....	88
6.8	Specimen Imaging.....	89
<b>7:</b>	<b>Accessories</b> .....	<b>91</b>
7.1	How to Install Accessories on the C-Arm.....	91
7.2	Patient Face Shields .....	92
7.2.1	How to Install and Remove the Retractable Face Shield.....	92
7.2.2	How to Use the Retractable Face Shield .....	93
7.2.3	How to Install and Remove the Conventional Face Shield.....	94
7.3	Compression Paddles .....	94
7.3.1	Routine Screening Paddles .....	96
7.3.2	Contact and Spot Compression Paddles .....	97
7.3.3	Magnification Paddles .....	97
7.3.4	Localization Paddles .....	98
7.3.5	Large Ultrasound Paddle.....	98
7.3.6	How to Install and Remove a Compression Paddle .....	99
7.3.7	Paddle Maintenance and Cleaning .....	99
7.3.8	Paddle Shift.....	100
7.3.9	FAST Compression Mode.....	100
7.4	Magnification Stand.....	102
7.4.1	How to Install and Remove the Magnification Stand.....	102
7.5	Crosshair Devices.....	104
7.5.1	How to Install and Remove the Localization Crosshair Device.....	104
7.5.2	How to Use the Localization Crosshair Device .....	105
7.5.3	How to Install and Remove the Magnification Crosshair Device.....	105
7.5.4	How to Align the Crosshair Device .....	106
<b>8:</b>	<b>Clinical Procedures</b> .....	<b>107</b>
8.1	Standard Workflow .....	107
8.1.1	Preparation .....	107
8.1.2	At the Gantry.....	107
8.1.3	At the Acquisition Workstation.....	108
8.2	Screening Procedure Example.....	108
8.2.1	Position the Patient.....	109
8.2.2	Set the Exposure Techniques.....	109
8.2.3	Acquire the Exposure.....	109
8.3	Procedure for Needle Localization with Tomosynthesis .....	111



---

<b>9: Maintenance and Cleaning</b>	<b>113</b>
9.1 Cleaning .....	113
9.1.1 General Information About Cleaning .....	113
9.1.2 For General Cleaning .....	113
9.1.3 To Prevent Possible Injury or Equipment Damage .....	114
9.1.4 Acquisition Workstation .....	114
9.2 Maintenance .....	116
9.2.1 Preventive Maintenance Schedules .....	116
9.2.2 About Reclamation .....	118
<b>10: System Administration Interface</b>	<b>119</b>
10.1 Admin Screen .....	119
10.2 About Screen .....	121
10.2.1 Licensing Tab .....	122
10.3 Change the User Language Preference .....	122
10.4 Set Auto-Hanging and Auto-Pairing .....	123
10.5 Set Multi Line Procedure Tabs .....	124
10.6 Enable and Set the Height Memory .....	125
10.7 Set Auto-Accept and Auto-Pend Images .....	127
10.8 Set the Contrast Defaults .....	128
10.9 Enable and Set the Default Height .....	129
10.10 System Tools .....	131
10.10.1 System Tools for the Radiologic Technologist Manager .....	132
10.10.2 Remote Access to Image Reports .....	133
10.11 Archive Tool .....	136
<b>Appendix A: Specifications</b>	<b>139</b>
A.1 Product Measurements .....	139
A.1.1 Tubestand (Gantry with C-Arm) .....	139
A.1.2 Acquisition Workstations .....	140
A.2 Operation and Storage Environment .....	144
A.2.1 General Conditions for Operation .....	144
A.2.2 Storage Environment .....	144
A.3 Radiation Shield .....	145
A.4 Electrical Input .....	145
A.4.1 Tubestand .....	145
A.4.2 Acquisition Workstation .....	145
A.5 Tubestand Technical Information .....	146
A.5.1 C-Arm .....	146
A.5.2 Compression .....	147
A.5.3 X-ray Tube .....	148
A.5.4 X-ray Beam Filtration and Output .....	148

---

# Selenia Dimensions System User Guide

## Table of Contents

---

A.5.5	X-ray Collimation .....	150
A.5.6	Light Field Indication.....	150
A.5.7	X-ray Generator.....	150
A.6	Imaging System Technical Information .....	151
A.6.1	Image Receptor .....	151
<b>Appendix B: System Messages and Alert Messages</b> .....		<b>153</b>
B.1	Error Recovery and Troubleshooting.....	153
B.2	Types of Messages .....	153
B.2.1	Fault Levels.....	153
B.2.2	System Messages .....	154
B.3	UPS Messages .....	156
<b>Appendix C: Use of Mobile System</b> .....		<b>157</b>
C.1	Conditions for Safety and Other Precautions .....	157
C.2	Specifications for Mobile Use .....	158
C.2.1	Shock and Vibration Limits.....	158
C.2.2	Coach Environment.....	158
C.3	Electrical Input .....	159
C.3.1	Gantry.....	159
C.3.2	Acquisition Workstation.....	159
C.4	Prepare the System for Travel .....	160
C.5	Prepare the System for Use.....	162
C.6	Test the System after Travel .....	163
C.6.1	Mobile System Controls and Functional Tests .....	163
C.6.2	Quality Control for Mobile Systems .....	163
<b>Appendix D: Dose Information</b> .....		<b>165</b>
D.1	EUREF Dose Tables .....	165
<b>Glossary of Terms</b> .....		<b>167</b>
<b>Index</b> .....		<b>169</b>

## List of Figures

Figure 1: Tubestand for Selenia® Dimensions® System .....	11
Figure 2: C-arm Overview .....	12
Figure 3: Acquisition Workstations.....	13
Figure 4: Emergency Off Switch Functionality.....	19
Figure 5: Label Locations.....	23
Figure 6: System Power Controls .....	25
Figure 7: Tubestand Controls and Indicators .....	26
Figure 8: Tubehead Display .....	27
Figure 9: Compression Device .....	27
Figure 10: Compression Device Display.....	27
Figure 11: C-arm Control Panel .....	28
Figure 12: Dual Function Footswitch.....	28
Figure 13: Universal Acquisition Workstation Controls and Displays .....	29
Figure 14: Premium Acquisition Workstation Controls and Displays.....	30
Figure 15: Standard Acquisition Workstation Controls and Displays .....	31
Figure 16: Turn to Reset the Emergency Off Switches.....	33
Figure 17: Universal Acquisition Workstation Power Buttons .....	33
Figure 18: Premium Acquisition Workstation Power Buttons .....	33
Figure 19: Standard Acquisition Workstation Power Buttons .....	33
Figure 20: Windows 10 Login Screen.....	34
Figure 21: Startup Screen.....	35
Figure 22: System Log In Screen.....	36
Figure 23: C-arm Control Panel (left side shown).....	38
Figure 24: Emergency Off Switch Functionality.....	47
Figure 25: Universal Acquisition Workstation Power Buttons .....	48
Figure 26: Premium Acquisition Workstation Power Buttons .....	48
Figure 27: Standard Acquisition Workstation Power Buttons .....	48
Figure 28: An Example Select Function to Perform Screen.....	49
Figure 29: Taskbar.....	50
Figure 30: Select Patient Screen.....	52
Figure 31: Enterprise Tab.....	53
Figure 32: Add Patient Screen.....	54
Figure 33: Split Patient Records Screen .....	55
Figure 34: Select the Correct Procedure to Split Patient Records.....	56
Figure 35: Filter Tab in the Patient Filter Screen.....	57
Figure 36: Procedure Screen.....	60
Figure 37: Paddle Shift Buttons.....	62
Figure 38: Procedure Info Dialog Box.....	63
Figure 39: Add Procedure Dialog Box .....	65
Figure 40: Add View Screen.....	66
Figure 41: Edit View Screen.....	67
Figure 42: Output Groups Field.....	69

# Selenia Dimensions System User Guide

## Table of Contents

---

Figure 43: An Example Custom Output Group.....	70
Figure 44: Select the Images for Export.....	72
Figure 45: Export Dialog Box .....	72
Figure 46: Print Screen .....	74
Figure 47: Image Display Screen.....	75
Figure 48: Exposure In Progress .....	77
Figure 49: Exposure Complete.....	77
Figure 50: Marked Images in a Procedure.....	78
Figure 51: Tools Tab (Tomosynthesis option shown) .....	80
Figure 52: Image Review Tools .....	81
Figure 53: Tools on the Notices Tab .....	82
Figure 54: Exposure Index .....	83
Figure 55: Display Modes .....	83
Figure 56: Tomosynthesis Slice Indicator .....	84
Figure 57: I-View 2D Contrast Screen .....	85
Figure 58: I-View 2D Contrast Screen, Waiting Period .....	86
Figure 59: I-View 2D Contrast Screen, Optimal Imaging Period .....	87
Figure 60: I-View 2D Contrast Settings.....	88
Figure 61: Procedure Screen for Specimens .....	89
Figure 62: Specimen Imaging Screen .....	90
Figure 63: C-arm Accessories .....	91
Figure 64: Align the Retractable Face Shield on the C-arm.....	92
Figure 65: Face Shield Installation.....	93
Figure 66: Face Shield Operation.....	93
Figure 67: How to Install the Conventional Face Shield .....	94
Figure 68: How to Install a Compression Paddle.....	99
Figure 69: How to Remove a Compression Paddle.....	99
Figure 70: The FAST Compression Mode Slide .....	101
Figure 71: Installation of the Magnification Stand .....	102
Figure 72: Installation of the Localization Crosshair Device .....	104
Figure 73: How to Install and Remove the Magnification Crosshair Device.....	105
Figure 74: Example of a Screening Procedure Screen .....	108
Figure 75: Exposure In Progress .....	110
Figure 76: Exposure Complete .....	110
Figure 77: Calculating needle depth.....	112
Figure 78: Admin Screen.....	119
Figure 79: System Tab of the About (the Acquisition Workstation) Screen.....	121
Figure 80: Licensing Tab of the About Screen.....	122
Figure 81: Enable Auto-Hanging and Auto-Pairing .....	123
Figure 82: Enable Multi Line Procedure Tabs.....	124
Figure 83: My Settings Button in the Admin Screen.....	125
Figure 84: Console Tab of the Edit Operator Screen .....	125
Figure 85: Height Adjust Control Panel.....	126
Figure 86: Desired Console Height and Current Console Height Fields .....	126
Figure 87: Set Image Auto Disposition .....	127

Figure 88: I-View 2D Contrast Default Settings .....	128
Figure 89: Preferences Button in the Admin Screen.....	129
Figure 90: Console Tab of the System Preferences Screen .....	129
Figure 91: Height Adjust Control Panel .....	130
Figure 92: Desired Console Height and Current Console Height Fields .....	130
Figure 93: System Tools Button .....	131
Figure 94: System Tools Screen.....	132
Figure 95: System Tools Login Screen.....	133
Figure 96: System Tools Welcome Screen .....	134
Figure 97: Create Image Report Parameters .....	134
Figure 98: Download the Image Report.....	135
Figure 99: Archive Button.....	136
Figure 100: Multi Patient On Demand Archive Screen .....	136
Figure 101: Export Screen .....	138
Figure 102: Tubestand (Gantry with C-arm) Measurements.....	139
Figure 103: Universal Acquisition Workstation Measurements .....	140
Figure 104: Premium Acquisition Workstation Measurements .....	141
Figure 105: Standard Acquisition Workstation Measurements .....	142
Figure 106: Mobile Universal Acquisition Workstation Measurements .....	143
Figure 107: Mobile Premium Acquisition Workstation Measurements.....	144
Figure 108: UPS LCD Display .....	156
Figure 109: Keyboard Tray Lock Knob, Right or Left Side (Universal Acquisition Workstation) .....	160
Figure 110: Keyboard Tray Lock Knob (Premium Workstation) .....	160
Figure 111: Tray Lock Release from Locked (A) to Unlocked (D) .....	160
Figure 112: Swivel Lock Knobs for the Image Display Monitor on the Mobile Workstation (series I).....	161
Figure 113: Swivel Lock Knobs for the Image Display Monitor on the Mobile Workstation (series II) .....	161
Figure 114: Tray Lock Release from Locked (A) to Unlocked (D) .....	162
Figure 115: Swivel Lock Knobs for the Image Display Monitor on the Mobile Workstation (series I).....	162
Figure 116: Swivel Lock Knobs for the Image Display Monitor on the Mobile Workstation (series II) .....	162



## List of Tables

Table 1: System Labels .....	24
Table 2: Compression Tests .....	39
Table 3: C-arm Up and Down Movement .....	40
Table 4: C-arm Counterclockwise Rotation.....	42
Table 5: C-arm Clockwise Rotation.....	43
Table 6: C-arm Rotation Switch .....	44
Table 7: Automatic C-arm Counterclockwise Rotation.....	45
Table 8: Automatic C-arm Clockwise Rotation .....	46
Table 9: C-arm Collimation .....	46
Table 10: Shifting Paddle .....	47
Table 11: Taskbar Menus .....	50
Table 12: The Select Patient Screen.....	52
Table 13: Filter Tab Options (Require Access Privileges) .....	58
Table 14: The Procedure Screen .....	61
Table 15: Procedure Groups .....	65
Table 16: Available Accessories .....	95
Table 17: User Preventive Maintenance.....	116
Table 18: Service Engineer Preventive Maintenance .....	117
Table 19: Admin Screen Functions.....	120
Table 20: Radiologic Technologist Manager—System Tools Functions.....	132
Table 21: Maximum mA Setting as a Function of kV .....	148
Table 22: System Messages.....	154
Table 23: 2D Dose (EUREF) .....	165
Table 24: BT Dose (EUREF) .....	165
Table 25: CEDM Dose (EUREF) .....	166





# Chapter 1 Introduction

Read all this information carefully before operating the system. Follow all warnings and precautions as stated in this manual. Keep this manual available during procedures. Physicians should tell patients about all potential risks and adverse events described in this manual with respect to the operation of the system.



---

**Note**

Hologic configures some systems to meet specific requirements. Your system configuration may not have all the options and accessories included in this manual.

---

## 1.1 Intended Use

R<sub>x</sub>Only

Caution: United States federal law restricts this device to sale by or on the order of a physician.

The Hologic® Selenia® Dimensions® system generates digital mammographic images that can be used for screening and diagnosis of breast cancer. The Selenia Dimensions (2D or 3D) system is intended for use in the same clinical applications as a 2D mammography system for screening mammograms. Specifically, the Selenia Dimensions system can be used to generate 2D digital mammograms and 3D mammograms. Each screening examination may consist of:

- a 2D FFDM image set  
- OR -
- a 2D and 3D image set, where the 2D image can be either an FFDM or a 2D image generated from the 3D image set

The Selenia Dimensions system may also be used for additional diagnostic workup of the breast.



---

**Note**

In Canada and Singapore, Tomosynthesis is not approved for screening, and must be used in conjunction with a 2D image (either a FFDM image or 2D image generated from the 3D image set).

---

### Contrast Enhanced Digital Mammography

Contrast Enhanced Digital Mammography (CEDM) is an extension of the existing indication for diagnostic mammography with the Selenia Dimensions system. The CEDM application shall enable contrast enhanced breast imaging using a dual energy technique. This imaging technique can be used as an adjunct following mammography and/or ultrasound exams to localize a known or suspected lesion.

#### 1.1.1 Contraindications

There are no known contraindications.

### 1.2 Potential Adverse Effects of Mammography Systems on Health

Below is a list of the potential adverse effects (such as complications) associated with the use of the device (these risks are the same as for other screen-film or digital mammography systems):

- Excessive breast compression
- Excessive x-ray exposure
- Electric shock
- Infection
- Skin irritation, abrasions, or puncture wounds

### 1.3 System Capabilities

The system provides the user interfaces for the performance of screening and diagnostic mammograms:

- Conventional mammography with a digital image receptor equivalent in size to large mammography film.
- Tomosynthesis scan with a digital image receptor equivalent in size to large mammography film (Tomosynthesis option).
- Conventional digital mammogram and tomosynthesis scan during one compression (Tomosynthesis option).

### 1.4 About the Genius 3D Mammography Exam

The Genius™ 3D Mammography™ exam (also known as Genius™ exam) is acquired on a Hologic® 3D Mammography™ system, and has a 2D and 3D™ image set. The 2D image can be either an acquired 2D image or a 2D image generated from the 3D™ image set. The Genius™ exam is only available on a Hologic® 3D Mammography™ system.

Genius™ 3D Mammography™ is the brand name of a Hologic 3D Mammography™ exam, and may not be available in all markets.

## 1.5 More Information About Tomosynthesis

The Hologic Selenia Dimensions system received FDA approval for the Hologic Tomosynthesis option on 11 Feb 2011 (refer to PMA number P080003). This FDA approval applies to screening and diagnostic imaging. More information is available from the FDA website at

<http://www.accessdata.fda.gov/scripts/cdrh/cfdocs/cfpma/pma.cfm?id=P080003>.

The Generated 2D option (C-View) in conjunction with Tomosynthesis received FDA approval on 16 May 2013 (refer to PMA number P080003 S001). More information is available from the FDA website at

<http://www.accessdata.fda.gov/scripts/cdrh/cfdocs/cfpma/pma.cfm?id=P080003S001>.

A list of scientific publications about Breast Tomosynthesis is available from the Hologic website. The majority of the studies were done with the commercially released Hologic Selenia Dimensions Tomosynthesis system. See the publication at

<http://www.hologic.com/sites/default/files/Tomo-Bibliography-Rev-13.pdf>.

The Hologic website has several white papers and summary cards about breast imaging publications. See the documents at <http://www.hologic.com/en/learning-center/white-papers/breastimaging/>.

Independent publications have examined Hologic Selenia Dimensions Tomosynthesis systems in population-based screening sequences in Europe. Results consistently show a significant increase in invasive cancer detection rate at the same time as a reduction in false positives. The following publications are recommended.

### **Integration of 3D digital mammography with tomosynthesis for population breast-cancer screening (STORM): a prospective comparison study.**

Ciatto S, Houssami N, Bernardi D, Caumo F, Pellegrini M, Brunelli S, Tuttobene P, Bricolo P, Fantò C, Valentini M, Montemezzi S, Macaskill P.

Lancet Oncol. 2013 Jun;14(7):583-9. doi: 10.1016/S1470-2045(13)70134-7. Epub 2013 Apr 25.

<http://www.ncbi.nlm.nih.gov/pubmed/23623721>

### **Prospective trial comparing full-field digital mammography (FFDM) versus combined FFDM and tomosynthesis in a population-based screening programme using independent double reading with arbitration.**

Skaane P, Bandos AI, Gullien R, Eben EB, Ekseth U, Haakenaasen U, Izadi M, Jebsen IN, Jahr G, Krager M, Hofvind S.

Eur Radiol. 2013 Aug;23(8):2061-71. doi: 10.1007/s00330-013-2820-3. Epub 2013 Apr 4.

<http://www.ncbi.nlm.nih.gov/pubmed/23553585>

### **Comparison of digital mammography alone and digital mammography plus tomosynthesis in a population-based screening program.**

Skaane P, Bandos AI, Gullien R, Eben EB, Ekseth U, Haakenaasen U, Izadi M, Jebsen IN, Jahr G, Krager M, Niklason LT, Hofvind S, Gur D.

Radiology. 2013 Apr;267(1):47-56. doi: 10.1148/radiol.12121373. Epub 2013 Jan 7.

<http://www.ncbi.nlm.nih.gov/pubmed/23297332>

### **Two-view digital breast tomosynthesis screening with synthetically reconstructed projection images: comparison with digital breast tomosynthesis with full-field digital mammographic images.**

Skaane P, Bandos AI, Eben EB, Jepsen IN, Krager M, Haakenaasen U, Ekseth U, Izadi M, Hofvind S, Gullien R.

Radiology. 2014 Jun;271(3):655-63. doi: 10.1148/radiol.13131391. Epub 2014 Jan 24

<http://www.ncbi.nlm.nih.gov/pubmed/24484063>

### **Breast Cancer Screening Using Tomosynthesis in Combination With Digital Mammography**

Sarah M. Friedewald, MD1; Elizabeth A. Rafferty, MD2; Stephen L. Rose, MD3,4; Melissa A. Durand, MD5; Donna M. Plecha, MD6; Julianne S. Greenberg, MD7; Mary K. Hayes, MD8; Debra S. Copit, MD9; Kara L. Carlson, MD10; Thomas M. Cink, MD11; Lora D. Barke, DO12; Linda N. Greer, MD13; Dave P. Miller, MS14; Emily F. Conant, MD15

JAMA. 2014;311(24):2499-2507. doi:10.1001/jama.2014.6095

<http://jama.jamanetwork.com/article.aspx?articleid=1883018>



---

#### **IMPORTANT:**

Hologic strongly recommends that users make themselves familiar with local or regional regulations. These regulations could impose restrictions on the different types of clinical use. Because the regulations could evolve and change over time, periodic review is recommended.

---

## **1.6 About C-View and Intelligent 2D**



---

#### **Note**

Intelligent 2D™ imaging technology may not be available in all regions. Contact your sales representative for information

---

### **1.6.1 C-View and Intelligent 2D Software**

The C-View™ and Intelligent 2D™ software uses image data available from a breast tomosynthesis acquisition to generate one digital mammogram (2D) per breast tomosynthesis acquisition. The synthesized 2D image is created without the need for an additional digital mammography exposure. The synthesized 2D image is designed to appear similar to, and serve the same purpose as, a digital mammogram (2D) when used as part of a screening study employing tomosynthesis. The C-View or Intelligent 2D image is interpreted in combination with a breast tomosynthesis image set and is not intended to be used without the accompanying breast tomosynthesis images to make a clinical decision or diagnosis.

## 1.6.2 C-View and Intelligent 2D Warnings



---

**Warning:**

**Do not make a clinical decision or diagnosis from the C-View or Intelligent 2D images without reviewing the accompanying tomosynthesis image set.**

---

Use the C-View or Intelligent 2D synthesized 2D images in the same way you would use conventional digital mammography (2D) when performing a screening study employing tomosynthesis.

- While reviewing the C-View or Intelligent 2D images for items or areas of interest, compare to a prior digital mammogram (2D) if priors exist and then review the related tomosynthesis images carefully.
- Carefully examine the entire tomosynthesis image set before making a clinical decision.



---

**Warning:**

**The appearance of a C-View or Intelligent 2D synthesized 2D image may differ from that of a conventional digital mammography (2D) image, just as 2D film and digital mammography (2D) images from different vendors may look different.**

---

Users should ensure they are adequately trained and are familiar with the appearance of C-View and Intelligent 2D synthesized 2D images before using them in conjunction with tomosynthesis image sets.

## 1.6.3 C-View and Intelligent 2D Theory of Operation

### Overview

The C-View and Intelligent 2D software is an image processing application for post-processing the pixel data from tomosynthesis data, captured on a Hologic tomosynthesis imaging system, into a digital mammography (2D) image. The C-View or Intelligent 2D synthesized 2D image can be used in place of a digital mammogram (2D) as part of a screening study employing tomosynthesis.

The C-View and Intelligent 2D software processes tomosynthesis data to generate 2D images which are designed to appear similar to and serve the same purpose as a digital mammogram (2D) when used as part of a screening study employing tomosynthesis.

### **Configuration**

The C-View and Intelligent 2D software has no user-configurable settings that influence the appearance of the resulting synthesized 2D images. C-View and Intelligent 2D images are produced in either DICOM Breast Tomosynthesis Image object format, as a single thick slice, or DICOM Digital Mammography Image object format. The site PACS administrator, in consultation with Hologic connectivity engineers, can select the output format most appropriate for the site's IT infrastructure and workstations. Each C-View or Intelligent 2D image DICOM header contains the information needed to differentiate it from any accompanying conventional 2D image(s) or tomosynthesis image sets in the same view. An annotation ("C-View" or "Intelligent 2D") will also be burned to the synthesized 2D image pixel data.

### **Workflow**

As with any imaging study, the technologist selects the patient and identifies the type of imaging procedure that will be done. For an exam with C-View or Intelligent 2D images, the process of imaging the subject and completing the study is all that is necessary. The C-View and Intelligent 2D software itself operates with no direct human intervention.

## **1.7 User Profiles**

### **1.7.1 Mammography Technologist**

- Meets all requirements that apply to the location in which the Mammography Technologist operates.
- Completed training on the mammography system.
- Has training in mammography positions.
- Knows how to operate a computer and its peripherals.

### **1.7.2 Radiologist**

- Meets all requirements that apply to the location in which the Radiologist operates.
- Knows how to operate a computer and its peripherals.

### **1.7.3 Medical Physicist**

- Meets all requirements that apply to the location in which the Medical Physicist operates.
- Knows about mammography.
- Has experience with digital imaging.
- Knows how to operate a computer and its peripherals.

## 1.8 Training Requirements

In the United States, users must be Registered Radiologic Technologists meeting criteria to perform mammography. The mammography users must meet all applicable MQSA personnel requirements under FDA guidelines for conventional and digital mammography.

The user has options available for training, which include but are not limited to:

- Onsite applications training by a Hologic Clinical Services Specialist
- Onsite on the job training also known as peer training

Additionally, the user manual is a guide for directions on how to use the system.

All users must make sure that they receive training on correct operation of the system before use on patients.

Hologic does not accept the responsibility for injury or damage from incorrect system operation.

## 1.9 Quality Control Requirements

Facilities in the United States must use the Quality Control Manual to create a Quality Assurance and Quality Control program. The facility must create the program to meet the requirements of the Mammography Quality Standards Act or to be accredited by ACR or another accreditation body.

Facilities outside the United States can use the Quality Control Manual as a guide to create a program to meet the local standards and regulations.

## 1.10 Where to Find the Installation Instructions

Installation instructions are available in the *Service Manual*.

## 1.11 Where to Find Technical Description Information

Technical description information is available in the *Service Manual*.

### 1.12 Warranty Statement

Except as otherwise expressly stated in the Agreement: i) Equipment manufactured by Hologic is warranted to the original Customer to perform substantially in accordance with published product specifications for one (1) year starting from the date of shipment, or if Installation is required, from the date of Installation (“Warranty Period”); ii) digital imaging mammography x-ray tubes are warranted for twenty-four (24) months, during which the x-ray tubes are fully warranted for the first twelve (12) months and are warranted on a straight-line prorated basis during months 13-24; iii) replacement parts and remanufactured items are warranted for the remainder of the Warranty Period or ninety (90) days from shipment, whichever is longer; iv) consumable Supplies are warranted to conform to published specifications for a period ending on the expiration date shown on their respective packages; v) licensed Software is warranted to operate in accordance with published specifications; vi) Services are warranted to be supplied in a workman-like manner; vii) non-Hologic Manufactured Equipment is warranted through its manufacturer and such manufacturer’s warranties shall extend to Hologic’s customers, to the extent permitted by the manufacturer of such non-Hologic Manufactured Equipment. Hologic does not warrant that use of Products will be uninterrupted or error-free, or that Products will operate with non-Hologic authorized third-party products. These warranties do not apply to any item that is: (a) repaired, moved, or altered other than by Hologic authorized service personnel; (b) subjected to physical (including thermal or electrical) abuse, stress, or misuse; (c) stored, maintained, or operated in any manner inconsistent with applicable Hologic specifications or instructions, including Customer’s refusal to allow Hologic recommended Software upgrades; or (d) designated as supplied subject to a non-Hologic warranty or on a pre-release or “as-is” basis.

### 1.13 Technical Support

Refer to the copyright page of this manual for contact information for product support.

### 1.14 Product Complaints

Report any complaints or problems in the quality, reliability, safety, or performance of this product to Hologic. If the device has caused or added to patient injury, immediately report the incident to Hologic. (See the copyright page for contact information.)

### 1.15 Hologic Cybersecurity Statement

















Hologic continuously tests the current state of computer and network security to examine possible security problems. When necessary, Hologic provides the updates to the product.

For Cybersecurity Best Practices documents for Hologic products, refer to the Hologic Internet site at [www.Hologic.com](http://www.Hologic.com).



## 1.16 Symbols

This section describes the Symbols on this system.

Symbol	Description
	Type B Applied Part
	Potential Equalization terminal
	Protective Earth terminal
	"OFF" (power)
	"ON" (power)
	Discard electrical and electronic equipment separately from standard waste. Send decommissioned material to Hologic or contact your service representative.
	Warning Electricity
	Manufacturer
	Date of Manufacture
	This system transmits radio frequency (RF) energy (non-ionizing radiation)
	Caution—Radiation
	Follow instructions for use
	Caution
	Catalog number
	Serial number
	Part number

## 1.17 Descriptions of Warnings, Cautions, and Notes

Descriptions of Warnings, Cautions, and Notes used in this manual:



---

---

**WARNING!**

**The procedures that you must follow accurately to prevent possible dangerous or fatal injury.**

---

---



---

**Warning:**

**The procedures that you must follow accurately to prevent injury.**

---



---

**Caution:**

**The procedures that you must follow accurately to prevent damage to equipment, loss of data, or damage to files in software applications.**

---



---

**Note**

Notes show additional information.

---

## 1.18 Document Conventions

When prompted to add text, enter the text printed in `monospaced font` exactly as shown.

## Chapter 2 General Information

### 2.1 System Overview

#### 2.1.1 Tubestand Overview

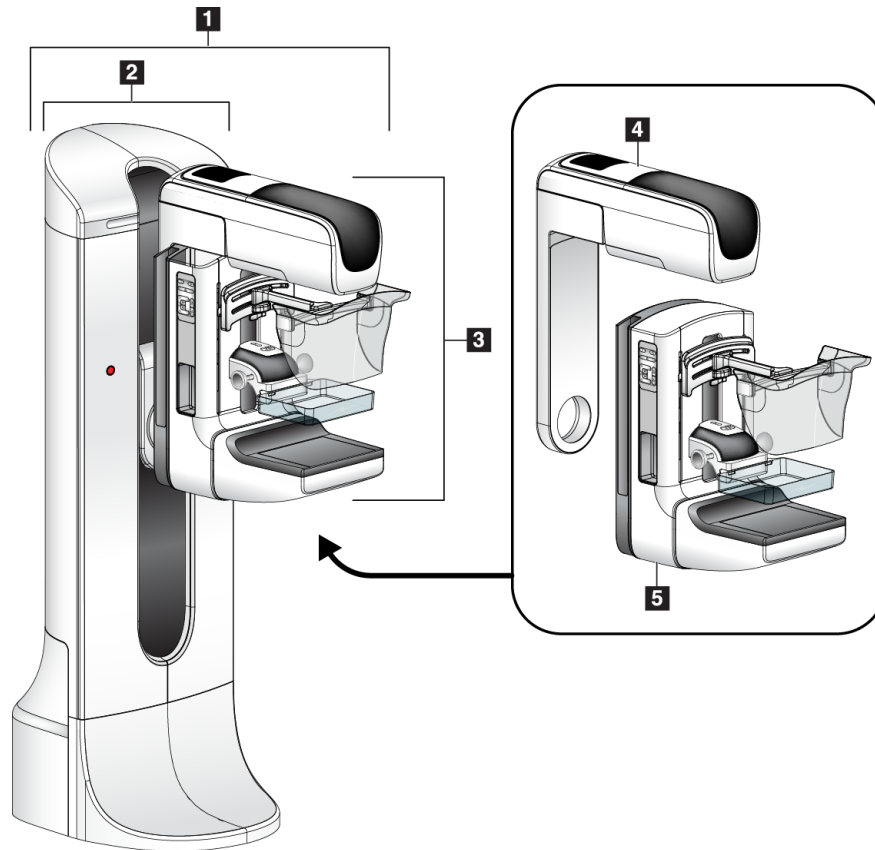
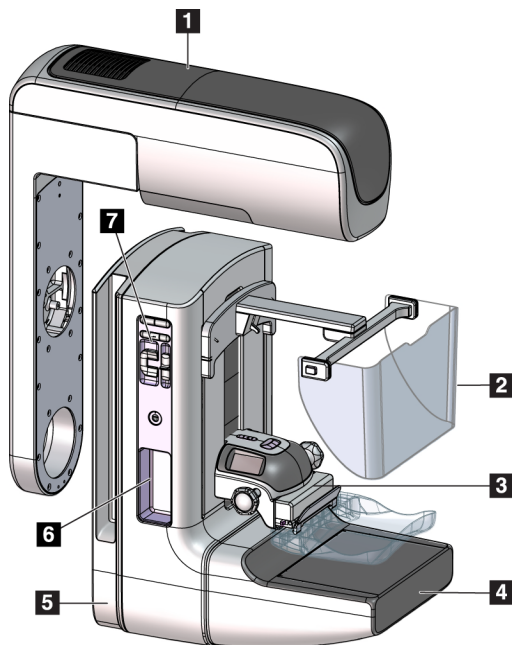


Figure 1: Tubestand for Selenia® Dimensions® System

#### Figure Legend

1. Tubestand (Gantry and C-arm)
2. Gantry
3. C-arm (Tube Arm and Compression Arm)
4. Tube Arm
5. Compression Arm

### 2.1.2 C-Arm Overview



#### Figure Legend

1. Tube Arm
2. Patient Face Shield
3. Compression Device
4. Image Receptor
5. Compression Arm
6. Patient Handle
7. C-arm Control Panel

Figure 2: C-arm Overview

### 2.1.3 Acquisition Workstation Overview

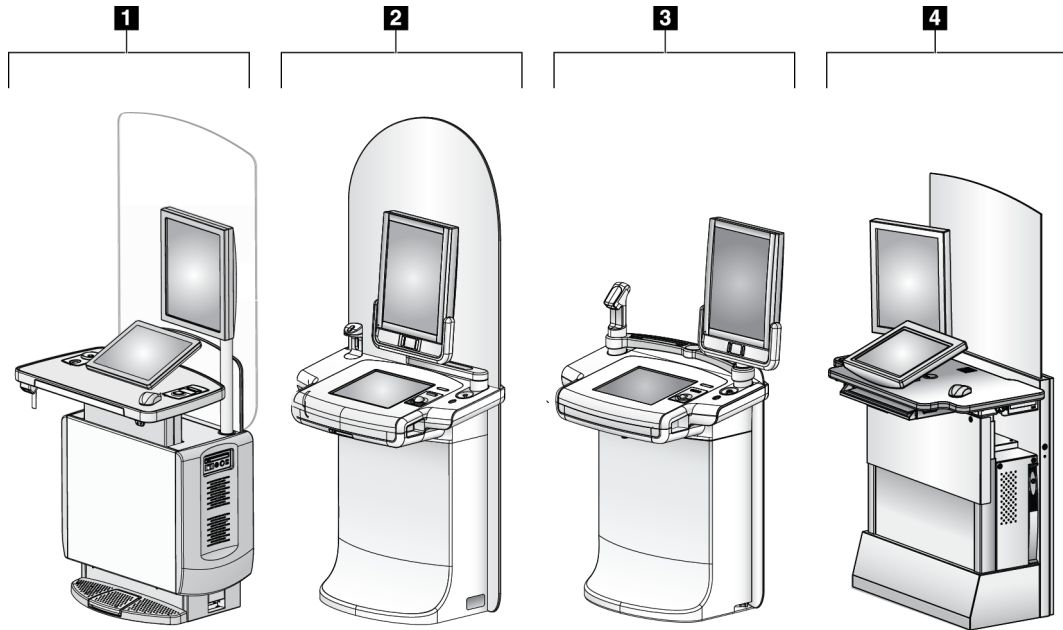


Figure 3: Acquisition Workstations

#### Figure Legend

1. Universal Acquisition Workstation
2. Premium Acquisition Workstation
3. Mobile Acquisition Workstation
4. Standard Acquisition Workstation

### 2.2 Safety Information

Read and understand this manual before you use the system. Keep the manual available during the patient procedures.

*Always* follow all the instructions in this manual. Hologic does not accept the responsibility for injury or damage from incorrect system operation. Hologic can schedule training at your facility.

The system has protective devices, but the Technologist must understand how to safely use the system. The Technologist must remember the health hazards of x rays.

### 2.3 Warnings and Precautions



This system is classified as CLASS I, TYPE B APPLIED PART, IPX0, permanently connected equipment, continuous operation with short term loading per IEC 60601-1. There are no special provisions to protect the system from flammable anesthetics or ingress of liquids.



---

---

#### **WARNING!**

**Risk of electric shock. Only connect this equipment to supply mains with Protective Earth.**

---

---



---

---

#### **WARNING!**

**For North American electrical safety requirements, use a Hospital Grade receptacle to supply a correct Ground.**

---

---



---

---

#### **WARNING!**

**Electrical equipment used near flammable anesthetics can cause an explosion.**

---

---



---

---

#### **WARNING!**

**To correctly isolate the system, attach only approved accessories or options to the system. Only approved personnel can change the connections.**

---

---



---

---

**WARNING!**

Keep a 1.5 meter safe distance between the patient and any non-patient devices.

Do not install non-patient system components (like the Workflow Manager, a diagnostic review workstation, or a hard copy printer) in the Patient Area.

---



---

---

**WARNING!**

Only trained Service Engineers authorized through Hologic can open any of the panels. This system contains lethal voltages.

---



---

---

**WARNING!**

The user must correct problems before the system is used. Contact an approved service representative for preventive maintenance.

---



---

---

**WARNING!**

After power failure, remove the patient from the system before you apply power.

---



---

---

**Warning:**

This device contains dangerous material. Send decommissioned material to Hologic or contact your service representative.

---



---

---

**Warning:**

C-arm movement is motorized.

---



---

---

**Warning:**

You increase the patient dose to high levels when you increase the AEC exposure adjustment. You increase the image noise or decrease image quality when you decrease the AEC exposure adjustment.

---



---

---

**Warning:**

Control the access to the equipment according to local regulations for radiation protection.

---

# Selenia Dimensions System User Guide

## Chapter 2: General Information

---



**Warning:**

The disk drives installed in this system are a Class I Laser Product. Prevent direct exposure to the beam. Hidden laser radiation exists if the case to a disk drive is open.

---



**Warning:**

The bar code scanner installed in this system is a Class II Laser Product. Prevent direct exposure to the beam. Hidden laser radiation exists if the cover is opened.

---



**Warning:**

Keep your full body behind the radiation shield during the exposure.

---



**Warning:**

Do not move the C-arm while the system retrieves the image.

---



**Warning:**

If a paddle touches possible infectious materials, contact your Infection Control Representative to remove contamination from the paddle.

---



**Warning:**

Do not leave the patient unattended during the procedure.

---



**Warning:**

Keep the hands of the patient away from all buttons and switches at all times.

---



**Warning:**

Place each footswitch in a position where, when used, they remain in reach of the Emergency Off Switches.

---



**Warning:**

Position the footswitches to prevent accidental operation by a patient or wheelchair.

---



**Warning:**

To prevent a higher radiation dose to the patient, only put approved materials in the x-ray beam path.

---





**Warning:**

This system can be dangerous to the patient and the user. Always follow the safety precautions for x-ray exposures.

---



**Warning:**

For exposures except magnification case studies, always use the Face Shield.

---



**Warning:**

The Face Shield does not protect the patient from radiation.

---



**Warning:**

Risk of entrapment. Make sure that the C-arm has 50 cm (20 inches) of clearance to any object during C-arm rotation. Do not use Auto Rotation when C-arm clearance is less than 50 cm (20 inches).

---



**Caution:**

The system is a medical device and not a normal computer. Only make approved changes to the hardware or software. Install this device behind a firewall for network security. The computer virus protection or network security for this medical device is not supplied (for example, a computer firewall). The network security and anti-virus provisions are the responsibility of the user.

---



**Caution:**

Do not turn off the Acquisition Workstation circuit breaker except in emergency. The circuit breaker can turn off the Uninterruptible Power Supply (UPS) and risk data loss.

---



**Caution:**

Risk of data loss. Do not put any magnetic media near or on devices that create any magnetic fields.

---



**Caution:**

Do not use any heat source (like a heating pad) on the image receptor.

---



**Caution:**

To prevent possible damage from thermal shock to the Digital Image Receptor, follow the recommended procedure to turn off the equipment.

---

# Selenia Dimensions System User Guide

## Chapter 2: General Information

---



---

**Caution:**

The display is calibrated for compliance to DICOM standards. Do not make any brightness or contrast adjustments to the display.

---



---

**Caution:**

Use the least possible amount of cleaning fluids. The fluids must not flow or run.

---



---

**Caution:**

To prevent damage to the electronic components, do not use disinfectant sprays on the system.

---



---

**Note:**

Hologic does not supply the Gantry power cable for some countries. If the power cable is not supplied, the installed cable must meet the following requirements and all local codes that apply: 3 conductor, 8 AWG (10 mm<sup>2</sup>) copper not more than 25 feet (7.62 meters) in length.

---

## 2.4 Emergency Off Switches

The Emergency Off switches remove the power from the Gantry and the Acquisition Workstation Lift Mechanism (on the workstations that include that option). Do not routinely use the Emergency Off switches to turn off the system.

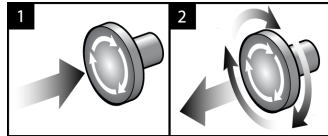


Figure 4: Emergency Off Switch  
Functionality

There are three Emergency Off switches, one on each side of the Gantry and one on the Acquisition Workstation.

1. To turn Off the Gantry and disable the Acquisition Workstation Lift Mechanism, press any of the Emergency Off switches.
2. To reset the Emergency Off switch, turn clockwise approximately one-quarter turn until the switch pops back out.

## 2.5 Interlocks

The system has safety interlocks:

- C-arm vertical movement and rotation are disabled when compression force is applied. A Service Engineer can configure the lockout force from 22 Newtons (5 pounds) to 45 Newtons (10 pounds).
- If the x-ray button and/or x-ray footswitch\* is released before the end of the exposure, the exposure stops and an alarm message is displayed.  
\* (The x-ray footswitch option is available only on the Universal Acquisition Workstation console.)
- When in Tomo mode, the system does not allow an exposure if the Grid is in the x-ray field (Tomosynthesis option).
- Mirror and Filter position flags also prevent x rays when the Light Field Mirror or the Filter Assembly is not correctly positioned.

## 2.6 Compliance

This section describes the mammography system compliance requirements and the responsibilities of the manufacturer.

### 2.6.1 Compliance Requirements

The manufacturer has the responsibility for the safety, reliability, and performance of this equipment with the following provisions:

- The electrical installation of the room meets all requirements.
- The equipment is used according to the *User Guide*.
- The assembly operations, extensions, adjustments, changes, or repairs are performed only by authorized persons.
- The network and communication equipment is installed to meet IEC Standards. The complete system (network and communications equipment and the mammography system) must be in compliance with IEC 60601-1.



**Caution:**

**Medical Electrical Equipment needs special precautions about EMC and must be installed, put into service and used according to the EMC information provided.**

---



**Caution:**

**Portable and mobile RF communications can affect medical electrical equipment.**

---



**Caution:**

**The use of unauthorized accessories and cables can result in increased emissions or decreased immunity. To keep the isolation quality for the system, attach only approved Hologic accessories or options to the system.**

---



**Caution:**

**The Medical Electrical (ME) Equipment or ME System should not be used adjacent to or stacked with other equipment. If adjacent or stacked use is necessary, make sure that the ME Equipment or ME System operates correctly in this configuration.**

---



**Caution:**

**This system is intended for use by healthcare professionals only. This system may cause radio interference or may disrupt the operation of nearby equipment. It may be necessary to take mitigation measures, such as re-orienting or relocating the equipment or shielding the location.**

---



**Caution:**

Changes or modifications not expressly approved by Hologic could void your authority to operate the equipment.

---



**Caution:**

This equipment has been tested and found to comply with the limits for a Class A digital device, pursuant to part 15 of the FCC Rules. These limits are designed to provide reasonable protection against harmful interference when the equipment is operated in a commercial environment. This equipment generates, uses, and can radiate radio frequency energy and, if not installed and used in accordance with the instruction manual, may cause harmful interference to radio communications. Operation of this equipment in a residential area is likely to cause harmful interference in which case the user will be required to correct the interference at his own expense.

---



**Caution:**

Based on ENCLOSURE PORT IMMUNITY to RF WIRELESS COMMUNICATIONS EQUIPMENT test level per IEC 60601-1-2 ed. 4, this device shows susceptibility to GMRS 460, FRS 460 transmission frequency. Provide a minimum separation of 30 cm between GMRS and FRS radios and the system.

---

## 2.6.2 Compliance Statements

The manufacturer states this device is made to meet the following requirements:



Medical – Applied electromagnetic radiation equipment as to electrical shock, fire and mechanical hazards only in accordance with ANSI/AAMI ES60601-1 (2005) and CAN/CSA-C22.2 No. 60601-1 (2008)

- CAN/CSA - ISO 13485-03 Medical Devices – Quality Management Systems – Requirements for Regulatory Purposes (Adopted ISO 13485:2003 second edition, 2003-07-15)
- CAN/CSA C22.2 NO. 60601-1-08 Medical Electrical Equipment – Part 1: General Requirements for Basic Safety and Essential Performance (Adopted IEC 60601-1:2005, third edition, 2005-12), includes Corrigendum 1:2011
- EN 60601-1:2006 Medical Electrical Equipment. General Requirements for Basic Safety and Essential Performance
- ETSI EN 300 330-1: V1.3.1, and ETSI EN 300 330-2: V1.5.1: 2006—Electromagnetic compatibility and Radio spectrum Matters (ERM); Short Range Devices (SRD); Radio equipment in the frequency range 9 kHz to 25 MHz and inductive loop systems in the frequency range 9 kHz to 30 MHz

# Selenia Dimensions System User Guide

## Chapter 2: General Information

---

- ETSI EN 301 489-1: V1.6.1, and ETSI EN 301 489-3: V1.8.1: 2008—Electromagnetic compatibility and Radio spectrum Matters (ERM); ElectroMagnetic Compatibility (EMC) standard for radio equipment and services
- FCC, 47 CFR Part 15, Subpart C, Section 15.225: 2009
- FDA, 21 CFR [Parts 820, 900 and 1020]
- IEC 60601-1 Ed. 3.0:2005 Medical Electrical Equipment – Part 1: General Requirements for Basic Safety and Essential Performance
- IEC 60601-1-2 Ed. 3.0:2007 Medical Electrical Equipment – Part 1-2: General Requirements for Basic Safety and Essential Performance - Collateral Standard: Electromagnetic Compatibility – Requirements and Tests
- IEC 60601-1-2 Ed. 4th:2015 Medical Electrical Equipment – Part 1-2: General Requirements for Basic Safety and Essential Performance - Collateral Standard: Electromagnetic Compatibility – Requirements and Tests
- IEC 60601-1-3 Ed. 2.0:2008 Medical Electrical Equipment – Part 1-3: General Requirements for Basic Safety and Essential Performance –Collateral Standard: Radiation Protection in Diagnostic X-Ray Equipment
- IEC 60601-2-28 Ed. 2.0:2010 Medical Electrical Equipment - Part 2-28: Particular Requirements for the Basic Safety and Essential Performance of X-ray Tube Assemblies for Medical Devices
- IEC 60601-2-45 Ed. 3.0:2011 Medical Electrical Equipment – Part 2-45: Particular Requirements for Basic Safety and Essential Performance of Mammographic X-Ray Equipment and Mammographic Stereotactic Devices
- RSS-210: Issue 7, 2007 Radio Standards Specification Low-power License-exempt Radiocommunication Devices: Category I Equipment
- ANSI/AAMI ES60601-1:2005 (IEC 60601-1:2005, MOD) Medical Electrical Equipment, Part 1: General Requirements for Basic Safety and Essential Performance, includes amendment (2010)

## 2.7 Label Locations

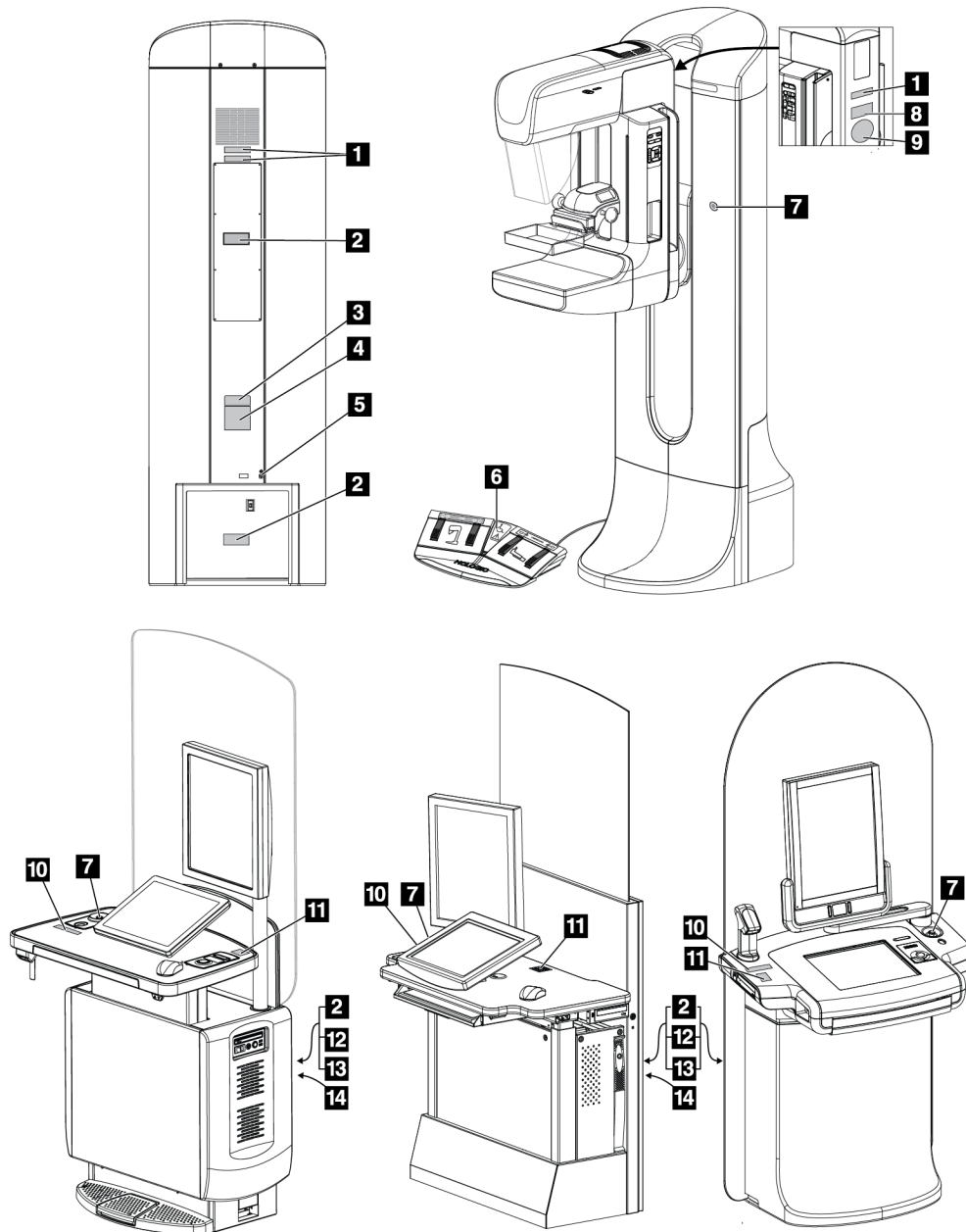
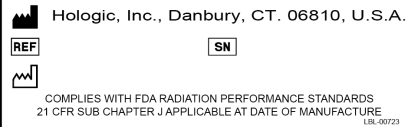
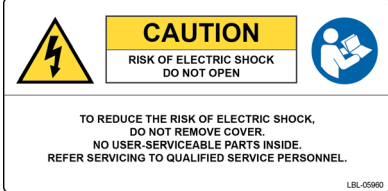





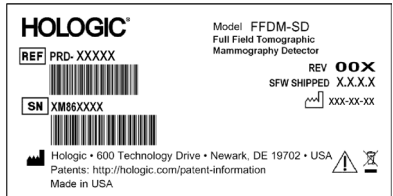
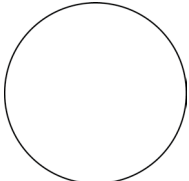


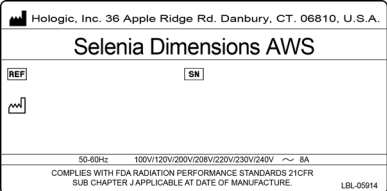
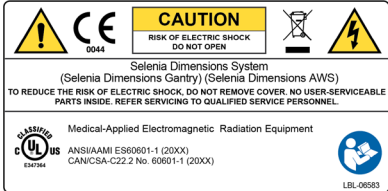
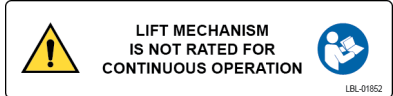


Figure 5: Label Locations

# Selenia Dimensions System User Guide

## Chapter 2: General Information

Table 1: System Labels

<p>1</p>  <p><i>Serialized Device</i></p>	<p>2</p>  <p><i>Electrical Shock Warning</i></p>	<p>3</p>  <p><i>System Model</i></p>
<p>4</p>  <p><i>System Nameplate</i></p>	<p>5</p>  <p><i>Potential Equalization Terminal</i></p> <p>6</p>  <p><i>Wheelchair Warning for Footswitch</i></p> <p>7</p>  <p><i>Emergency Stop Switch</i></p>	<p>8</p>  <p><i>Tomographic Mammography Detector</i></p>
<p>9</p>  <p><i>Vendor-supplied X-ray Tube Serial Number</i></p>	<p>10</p>  <p><i>X-ray Device Warning</i></p>	<p>11</p>  <p><i>Technical Support Contact</i></p>
<p>12</p>  <p><i>Acquisition Workstation Nameplate</i></p>	<p>13</p>  <p><i>Compliance</i></p>	<p>14</p>  <p><i>Acquisition Workstation Lift Limit</i></p>



## Chapter 3 System Controls and Indicators

### 3.1 System Power Controls

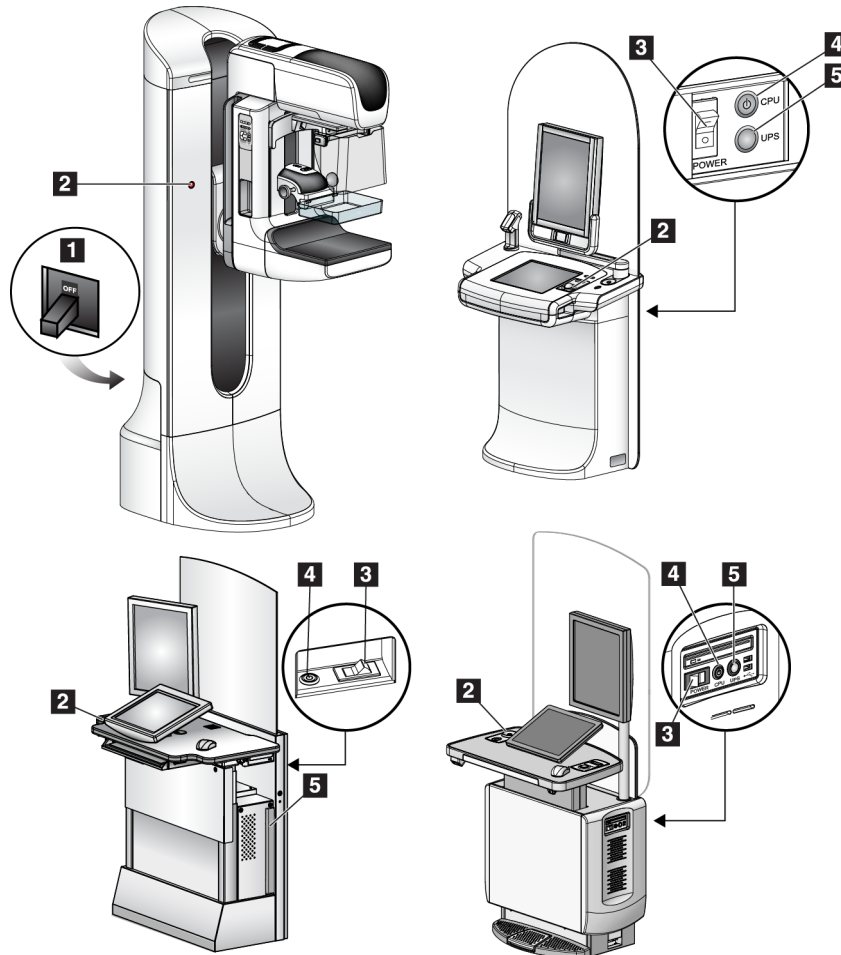
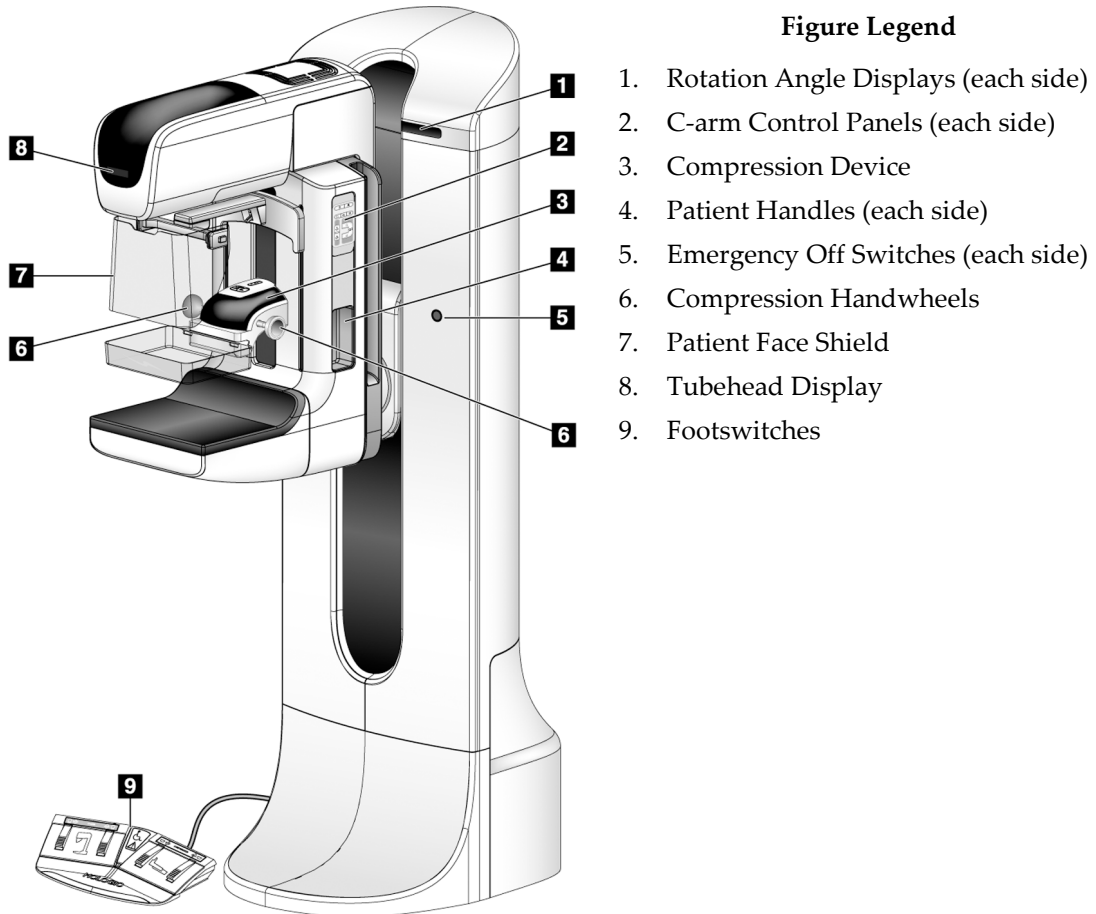


Figure 6: System Power Controls

#### Figure Legend

1. Gantry Power Circuit Breaker
2. Emergency Off Switch (two on the Gantry, one on the Acquisition Workstation)
3. Acquisition Workstation Power Switch
4. Computer Power On/Reset Button
5. Uninterruptible Power Supply (UPS) Power Button

### 3.2 Tubestand Controls and Indicators



*Figure 7: Tubestand Controls and Indicators*

### 3.2.1 Tubehead Display

The Tubehead Display shows:

- SID
- Filter Type
- Collimator Setting
- Paddle Position



Figure 8: Tubehead Display

### 3.2.2 Compression Device Controls and Display

#### Figure Legend

1. Manual Compression Handwheels
2. Paddle Shift Buttons
3. AEC Sensor Buttons
4. Compression Device Display
5. FAST Compression Mode Slide
6. Paddle Clamp

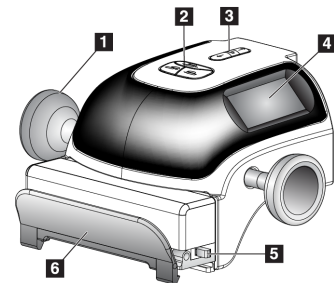


Figure 9: Compression Device

The Compression Device Display shows:

- AEC Sensor Position
- Compression Force (displays 0.0 when force is less than 4 pounds)
- Compression Thickness
- Angle of the C-arm after rotation (for 5 seconds)



Figure 10: Compression Device Display

### 3.2.3 C-Arm Control Panels

The C-arm control panels provide the Collimator and C-arm functions. Refer to [Perform the Functional Tests](#) on page 38.

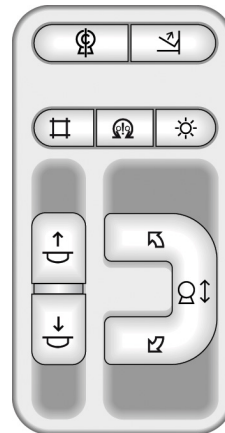


Figure 11: C-arm Control Panel

### 3.2.4 Dual Function Footswitch



**Warning:**

Place each footswitch in a position where, when used, they remain in reach of the Emergency Off Switches.



**Warning:**

Position the footswitches to prevent accidental operation by a patient or wheelchair.

To use the footswitch:

- Press the footswitch to actuate.
- Release the footswitch to stop the movement.

**Figure Legend**

1. C-arm Down
2. C-arm Up
3. Compression Down
4. Compression Up

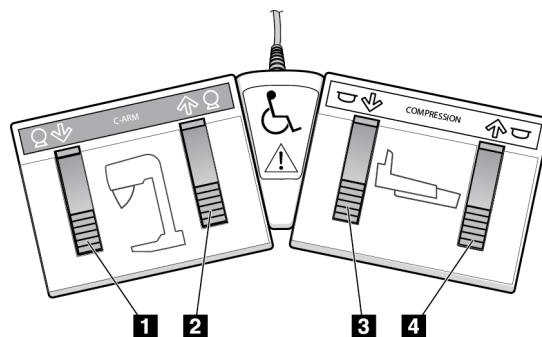


Figure 12: Dual Function Footswitch

### 3.3 Acquisition Workstation Controls and Indicators



**Note**

Hologic configures some systems to meet specific requirements. Your system configuration may not have all the options and accessories included in this manual.

#### 3.3.1 Universal Acquisition Workstation Controls and Displays

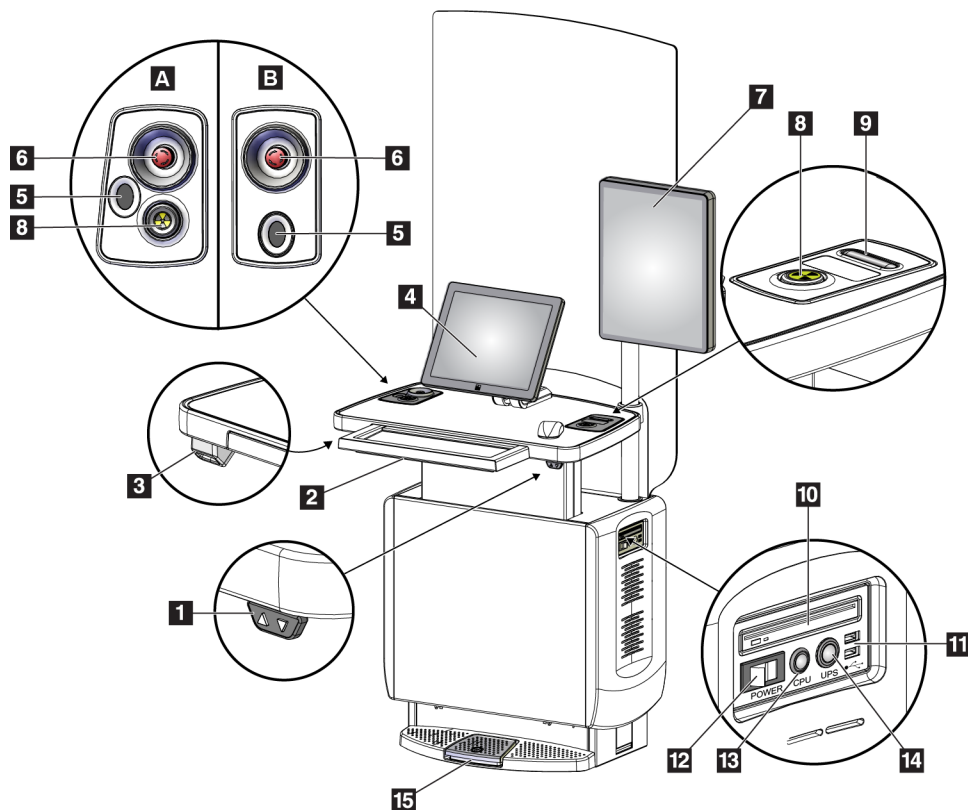


Figure 13: Universal Acquisition Workstation Controls and Displays

**Figure Legend**

- |                               |  |
|-------------------------------|--|
| 1. Height Adjustment Switch   | 10. CD/DVD Drive                                       |
| 2. Keyboard (in drawer)       | 11. USB Ports  |
| 3. Bar Code Scanner           | 12. Acquisition Workstation Power Switch               |
| 4. Control Monitor            | 13. Computer Power On/Reset Button                     |
| 5. Fingerprint Scanner*       | 14. Uninterruptible Power Supply (UPS)<br>Power Button |
| 6. Emergency Off Switch*      | 15. X-ray Footswitch                                   |
| 7. Image Display Monitor      |  |
| 8. X-ray Activation Button*   |  |
| 9. Compression Release Button |  |

\*A = series II Universal Acquisition Workstation layout;  
B = series I Universal Acquisition Workstation layout



**Note**

The controls for the Universal Acquisition Workstation installed in a mobile environment are the same as the controls for the Universal Acquisition Workstation.

### 3.3.2 Premium Acquisition Workstation Controls and Displays

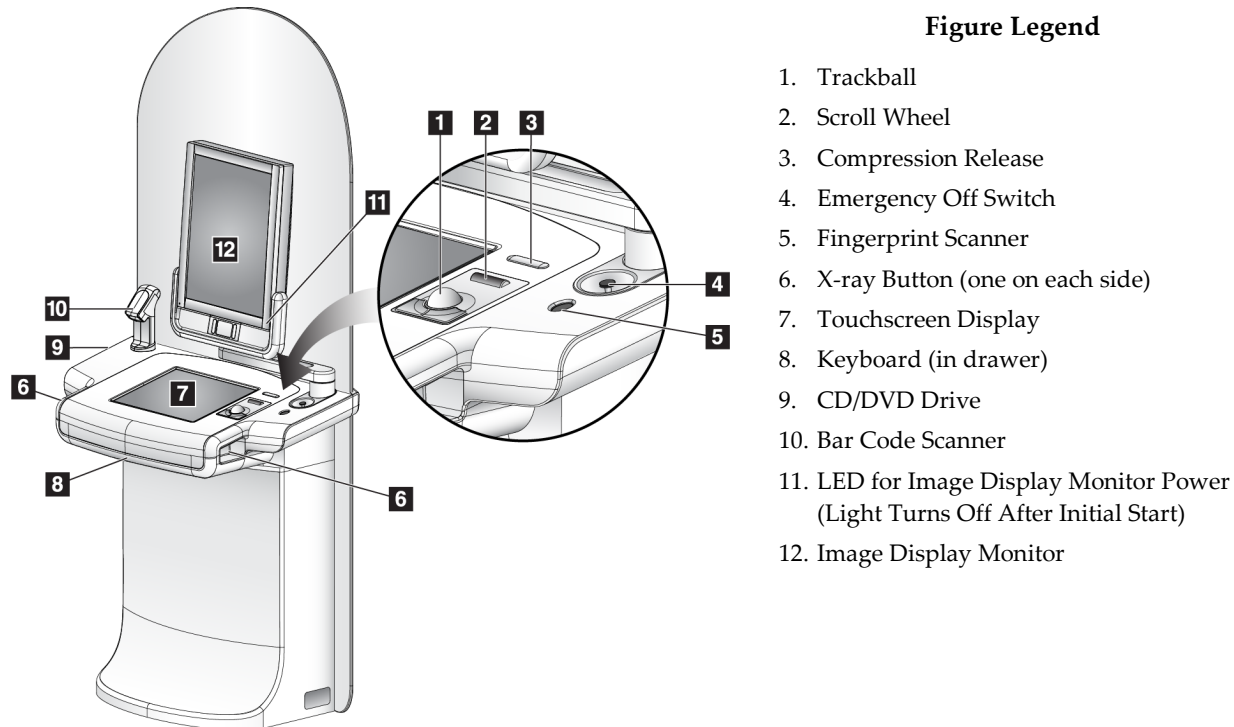


Figure 14: Premium Acquisition Workstation Controls and Displays



**Note**

The controls for the Premium Acquisition Workstation installed in a mobile environment are the same as the controls for the Premium Acquisition Workstation.

### 3.3.3 Standard Acquisition Workstation Controls and Displays

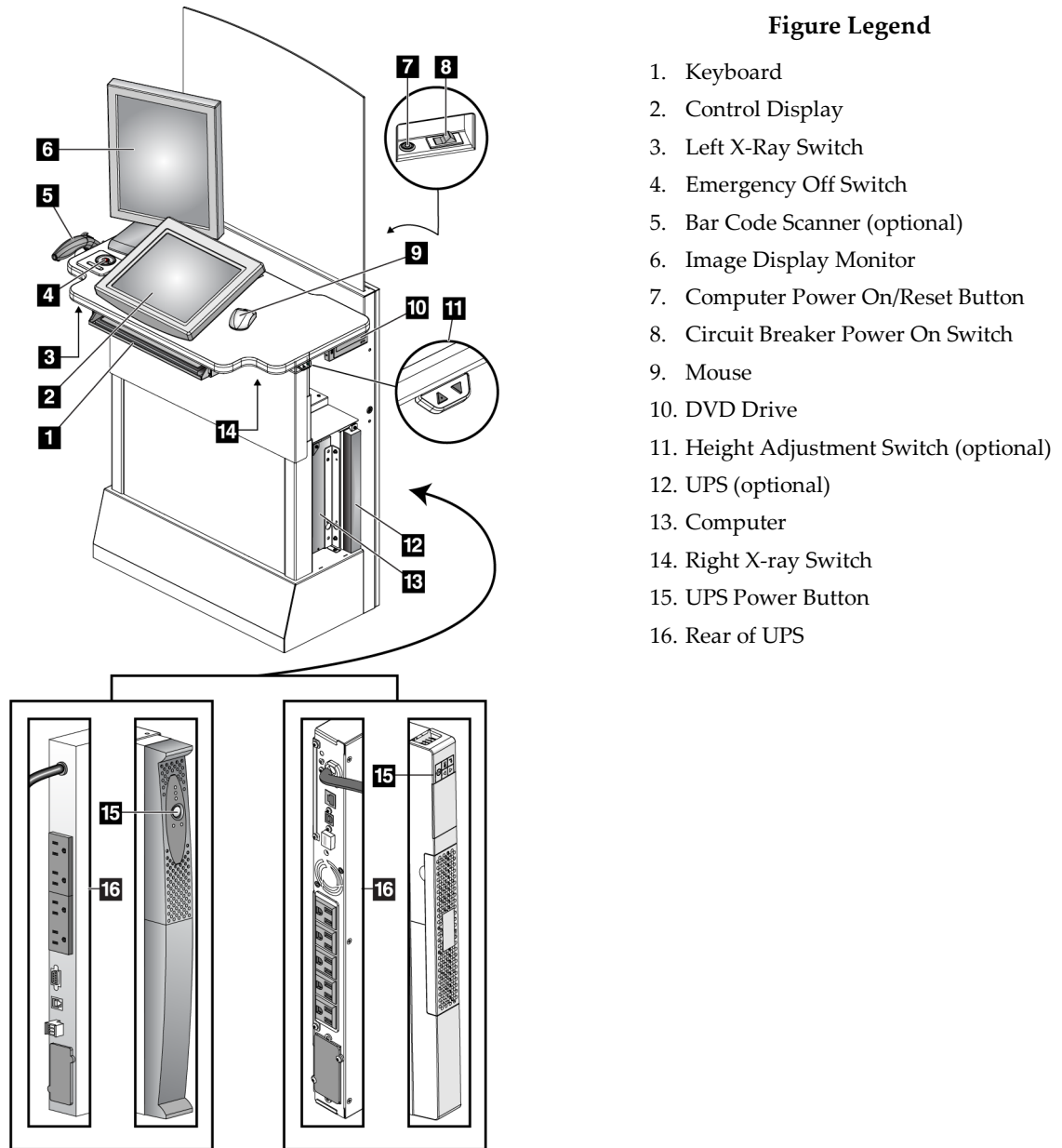


Figure 15: Standard Acquisition Workstation Controls and Displays

### 3.3.4 Keyboard

Use the keyboard in the front drawer of the Acquisition Workstation for data entry.

### 3.3.5 Bar Code Scanner

Use this device for data entry from bar codes for patient or procedure records.

### 3.3.6 Universal Acquisition Workstation Display

Use the mouse or the optional Touchscreen to select items.

### 3.3.7 Premium Acquisition Workstation Touchscreen Display

Use the Touchscreen or trackball to select items.

### 3.3.8 Standard Acquisition Workstation Display

Use the mouse to select items.

### 3.3.9 Image Display Monitor

See the images on the Image Display Monitor.



#### Note

Your Image Display Monitor may appear different from the Image Display Monitorss shown in this manual, but the function is identical.

---



## Chapter 4 Startup, Functional Tests, and Shutdown

### 4.1 How to Start the System



#### Note

If the system remains on overnight, reboot the system daily to guarantee best performance.

#### 4.1.1 Preparation

1. Make sure that there are no obstructions to C-arm movement or to the view of the Operator.
2. Make sure that all three Emergency Off switches are in the reset position (unpushed).

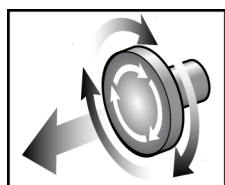


Figure 16: Turn to Reset the Emergency Off Switches

3. Make sure that the Gantry circuit breaker is in the On position.

#### 4.1.2 Startup

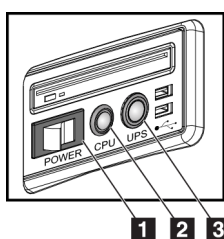


Figure 17: Universal Acquisition Workstation Power Buttons

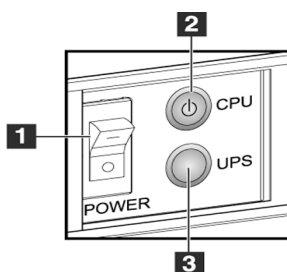


Figure 18: Premium Acquisition Workstation Power Buttons

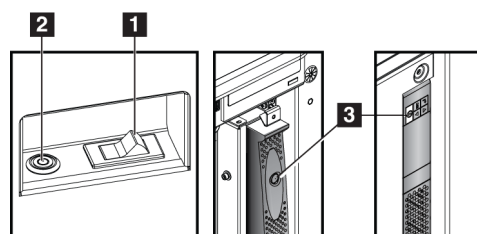


Figure 19: Standard Acquisition Workstation Power Buttons

#### Figure Legend

1. Acquisition Workstation Power Switch
2. Computer Power On/Reset Button
3. UPS (optional) Power Button

### To start up the system:

1. If the UPS was turned OFF, press the UPS power button to apply power to the UPS (see the previous figures).
2. Turn ON the Acquisition Workstation power switch (see the previous figures).
3. Press the computer power button (see the previous figures). The computer powers on and the Windows 10 login screen opens on the Acquisition Workstation control monitor.

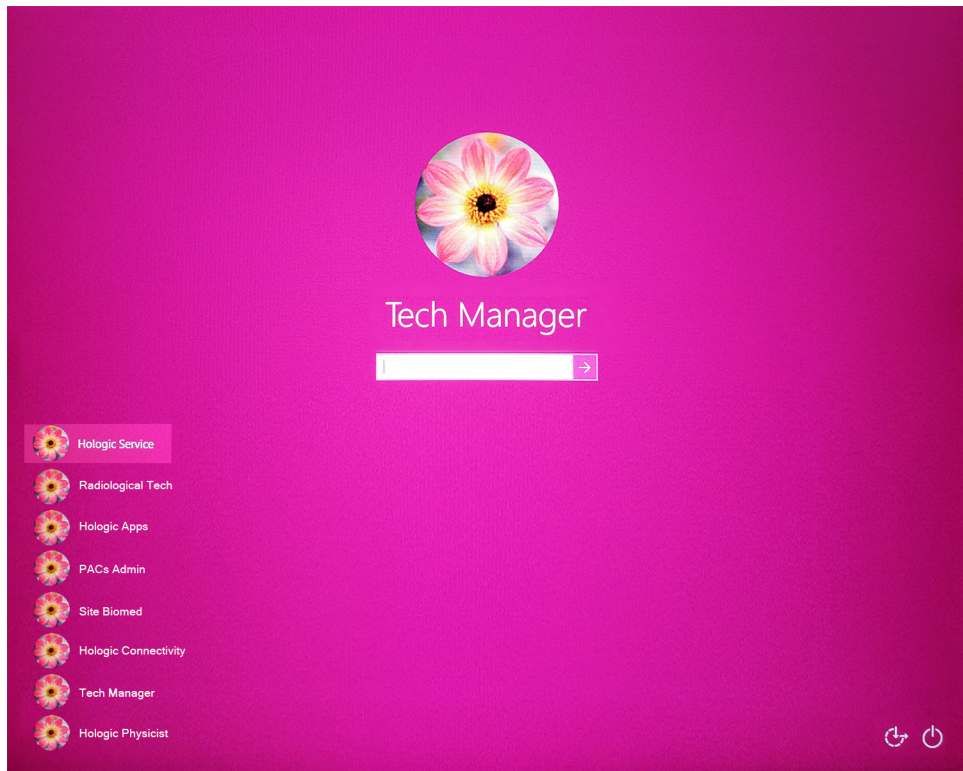


Figure 20: Windows 10 Login Screen

4. Select your user name and enter your password.

5. The *Startup* screen for the Selenia Dimensions system opens on the Acquisition Workstation control monitor. The Gantry then automatically powers on.

## Selenia Dimensions

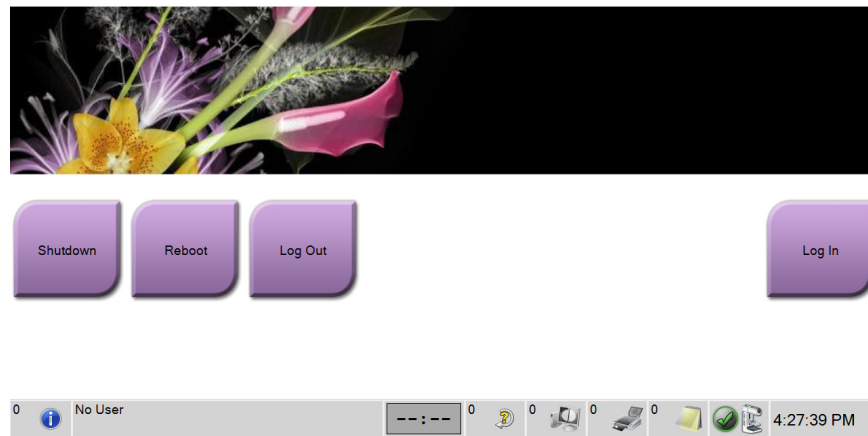


Figure 21: Startup Screen



**Note**

To log out of the Windows 10 operating system, select the **Log Out** button.

---



**Note**

The *Startup* screen includes a **Shutdown** button that turns off the system, and a **Reboot** button that restarts the system.

---



**Note**

The system can require between five minutes and fifteen minutes to prepare for image acquisition. The wait time depends on the detector power configuration. A timer in the Taskbar displays the wait time before the system is ready. Do not acquire clinical or QC images unless the System Status Icon indicates that the system is Ready.

---

### 4.1.3 Log In

1. Select the **Log In** button on the *Startup* screen.
2. The *Select an Operator* (System Log In) screen opens and shows a list of Manager and Technologist user names. If necessary, select the **Show All** button to list the Service, Applications, and Physicist user names.

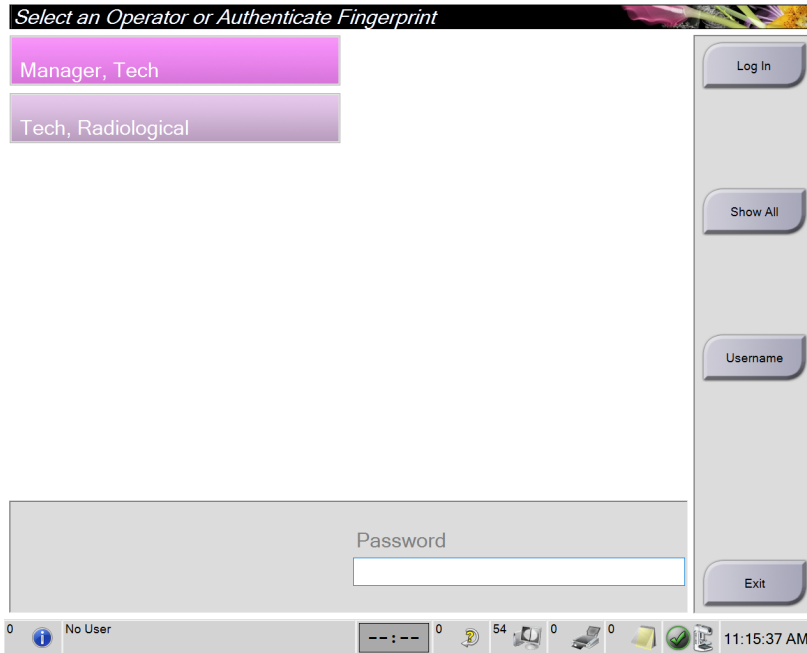


Figure 22: System Log In Screen

3. Use one of the following methods to log into the system:

- Select the applicable user name button. Type in your password then select the **Log In** button.
- Select the **Username** button. Type in your user name and password then select the **Log In** button.
- Validate your fingerprint by pressing your finger in the fingerprint scanner.



---

**Note**

Most of the unique, repeatable fingerprint information is from the pad of the finger, not the fingertip. Flat finger placement as shown in the left image results in fast and accurate fingerprint identification.

---



Correct operation



Incorrect operation

---

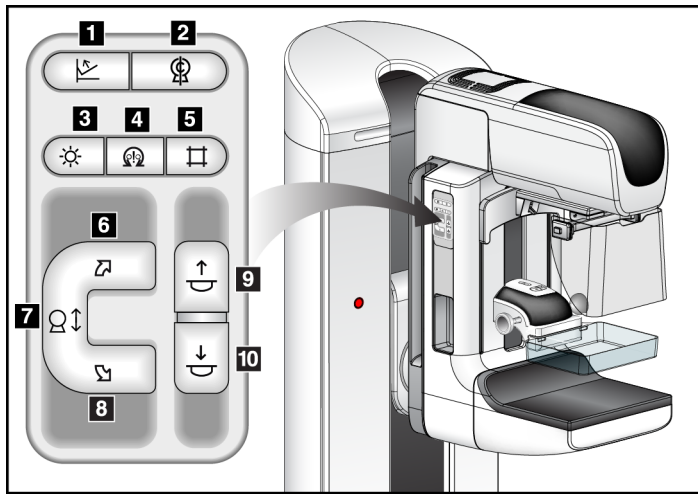
**Note**

If Quality Control tasks are due, the *Select Function to Perform* screen opens. You can perform quality tasks or you can select **Skip**.

---

## 4.2 Perform the Functional Tests

To make sure that the controls operate correctly, do the Functional Tests as part of your monthly visual checklist. Make sure that all buttons work correctly (C-arm control panels, left and right sides).



### Figure Legend

1. Compression Release
2. C-arm Zero
3. Light Field Lamp
4. Motor Enable
5. Collimator Override
6. Clockwise C-arm Rotation
7. C-arm Up and Down
8. Counterclockwise C-arm Rotation
9. Compression Up
10. Compression Down

Figure 23: C-arm Control Panel (left side shown)



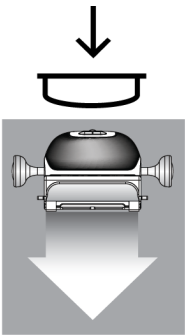
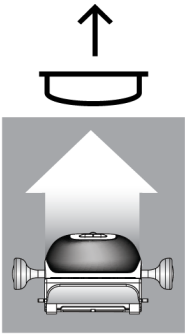

### Note

C-arm vertical movement and rotation are disabled when compression force is applied. A Service Engineer can configure the lockout force from 22 Newtons (5 pounds) to 45 Newtons (10 pounds).

---

### 4.2.1 Compression Functional Tests

*Table 2: Compression Tests*

Function	Functional Test
<p>Compression Down</p> 	<p>Press a <b>Compression Down</b> button:</p> <ul style="list-style-type: none"> <li>• The compression brake engages.</li> <li>• The light field lamp illuminates.</li> <li>• The compression device lowers.</li> </ul> <p><i>Note... When you press the <b>Compression Down</b> button, the compression brake remains engaged until the <b>Compression Release</b> button is pressed.</i></p> <p>Compression down movement stops:</p> <ul style="list-style-type: none"> <li>• When you release the button.</li> <li>• When you reach the Down Force limit.</li> <li>• When you reach the lower travel limit.</li> </ul>
<p>Compression Up</p> 	<p>Press a <b>Compression Up</b> button:</p> <ul style="list-style-type: none"> <li>• The Compression Device moves toward the top.</li> </ul> <p><i>Note... The <b>Compression Up</b> button does NOT release the Compression Brake.</i></p> <p>Compression up movement automatically stops:</p> <ul style="list-style-type: none"> <li>• When you release the button.</li> <li>• When you reach the upper travel limit.</li> </ul>
<p>Compression Release</p> 	<p>Press the <b>Compression Release</b> button:</p> <ul style="list-style-type: none"> <li>• The Compression Motor Brake releases.</li> <li>• The Compression Device lifts.</li> </ul>

### 4.2.2 C-Arm Movement Functional Tests

#### C-Arm Up and Down Movement

Table 3: C-arm Up and Down Movement

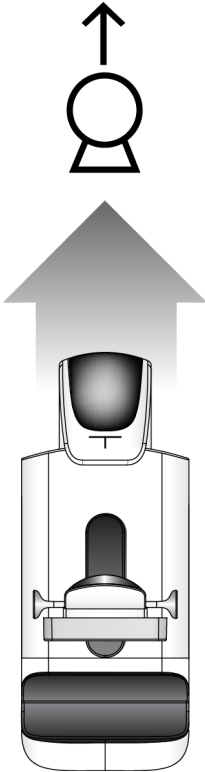
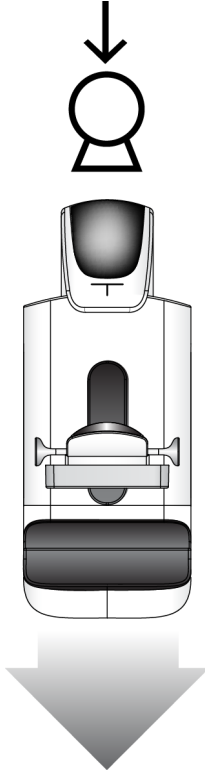
Function	Functional Test
<p data-bbox="378 499 500 531">C-arm Up</p> 	<p data-bbox="724 512 1047 543">Press the <b>C-arm Up</b> button.</p> <ul data-bbox="773 558 1390 888" style="list-style-type: none"><li>• C-arm movement stops when the button is released.</li><li>• C-arm movement stops when the C-arm reaches the upper travel limit.</li><li>• C-arm vertical movement and rotation are disabled when compression force is applied. A Service Engineer can configure the lockout force from 22 Newtons (5 pounds) to 45 Newtons (10 pounds).</li></ul>



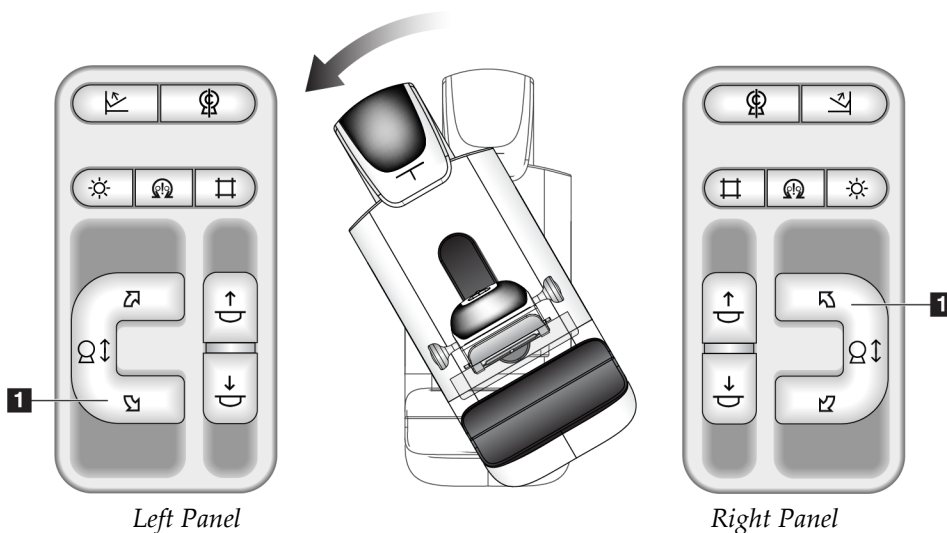
Table 3: C-arm Up and Down Movement

Function	Functional Test
<p data-bbox="428 365 581 394">C-arm Down</p>  <p>The diagram illustrates the C-arm down movement. At the top, a small downward-pointing arrow is positioned above a circle with a triangle below it, representing a button. Below this is a top-down view of the C-arm assembly, showing the upper housing, the central column, and the lower housing. A large, shaded downward-pointing arrow is positioned at the bottom of the diagram, indicating the direction of movement.</p>	<p data-bbox="774 373 1133 403">Press the <b>C-arm Down</b> button.</p> <ul data-bbox="821 422 1438 751" style="list-style-type: none"><li>• C-arm movement stops when the button is released.</li><li>• C-arm movement stops when the C-arm reaches the lower travel limit.</li><li>• C-arm vertical movement and rotation are disabled when compression force is applied. A Service Engineer can configure the lockout force from 22 Newtons (5 pounds) to 45 Newtons (10 pounds).</li></ul>

**C-Arm Rotation**

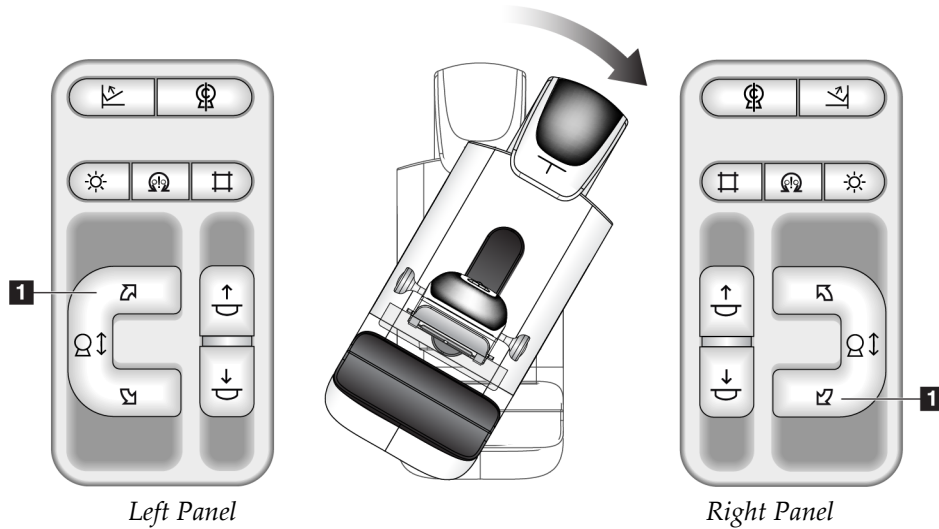
*Table 4: C-arm Counterclockwise Rotation*

Function	Functional Test
Counterclockwise C-arm Rotation	Press the <b>Counterclockwise C-arm Rotation</b> button (item 1) to start counterclockwise C-arm rotation. C-arm movement stops when the switch is released. To fine-tune the C-arm rotation in one degree segments, hold the button down for a second, then let go quickly. Repeat as necessary.



*Table 5: C-arm Clockwise Rotation*

Function	Functional Test
Clockwise C-arm Rotation	Press the <b>Clockwise C-arm Rotation</b> button (item 1) to start clockwise C-arm rotation. C-arm movement stops when the switch is released. To fine-tune the C-arm rotation in one degree segments, hold the button down for a second, then let go quickly. Repeat as necessary.

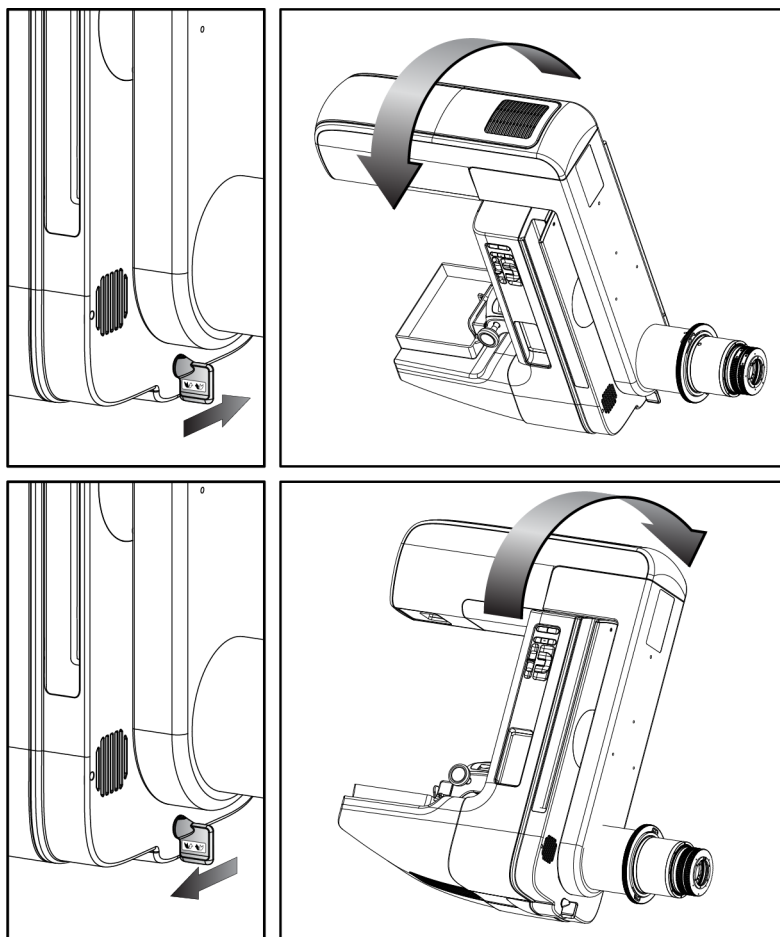


# Selenia Dimensions System User Guide

## Chapter 4: Startup, Functional Tests, and Shutdown

Table 6: C-arm Rotation Switch

Function	Functional Test
C-arm Rotation Switch	Push the C-arm Rotation switch away from you to move the C-arm toward you. Pull the C-arm Rotation switch toward you to move the C-arm away. C-arm movement stops when the switch is released.



**C-Arm Automatic Rotation (Auto-Rotate)**





**Warning:**

**Risk of entrapment. Make sure that the C-arm has 50 cm (20 inches) of clearance to any object during C-arm rotation. Do not use Auto Rotation when C-arm clearance is less than 50 cm (20 inches).**



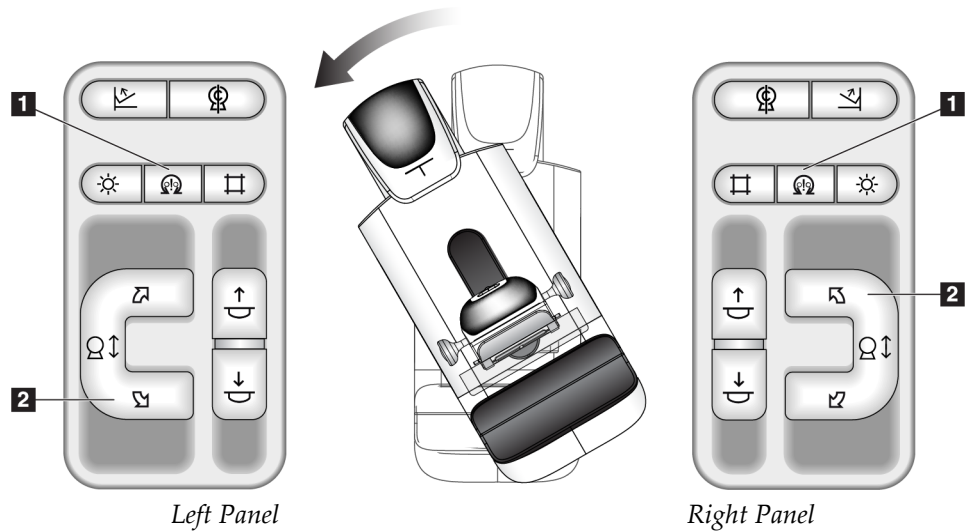
**Note**

To stop the C-arm automatic rotation movement, press any button or the Emergency Stop switch.

<p>Motor Enable</p> 	<p>Press the <b>Motor Enable</b> button and a <b>Rotation</b> button at the same time to enable auto-rotation movement clockwise or counterclockwise.</p>
<p>C-arm Zero</p> 	<p>Press the <b>Motor Enable</b> button and the <b>C-arm Zero</b> button at the same time. Release the buttons. The machine beeps and the C-arm returns automatically to the zero position.</p>

*Table 7: Automatic C-arm Counterclockwise Rotation*

Function	Functional Test
<p>Automatic Counterclockwise C-arm Rotation</p>	<p>Press the <b>Motor Enable</b> button (item 1) and the <b>Counterclockwise C-arm Rotation</b> button (item 2) at the same time. Release the buttons. The machine beeps and the C-arm moves automatically counterclockwise.</p>

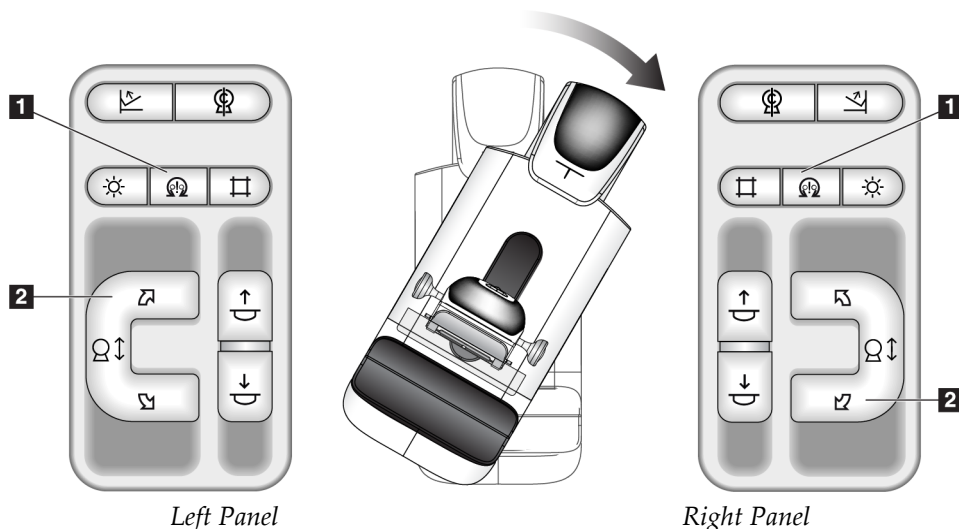


# Selenia Dimensions System User Guide

## Chapter 4: Startup, Functional Tests, and Shutdown



Table 8: Automatic C-arm Clockwise Rotation

Function	Functional Test
Automatic Clockwise C-arm Rotation	Press the <b>Motor Enable</b> button (item 1) and the <b>Clockwise C-arm Rotation</b> button (item 2) at the same time. Release the buttons. The machine beeps and the C-arm moves automatically clockwise.



## Collimation

Table 9: C-arm Collimation

Function	Functional Test
Collimator Override 	The <b>Collimator Override</b> button changes the collimation through the different x-ray fields. Press the <b>Light Field Lamp</b> button to show the x-ray field, then press the <b>Collimator Override</b> button to select an x-ray field.
Light Field Lamp 	For compression paddles: Press the <b>Light Field Lamp</b> button to see the x-ray field for two minutes. For localization paddles: Press the <b>Light Field Lamp</b> button to see the x-ray field for the configured amount of time. The default time for biopsy or needle localization paddles is ten minutes. Press the <b>Light Field Lamp</b> button again to turn off the light field lamp. The light field lamp automatically illuminates with the start of the Compression Down movement.

## Shifting Paddles

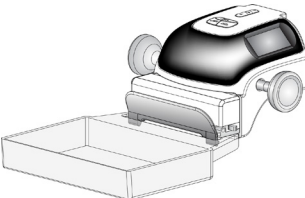


### Note

Most paddles can be used with the Shifting Paddle function. The large 24 x 29 cm Frameless Screening Paddle, the large 24 x 29 cm SmartCurve™ system paddle, and the Magnification paddles are not compatible with the Shifting Paddle function.

Use the 18 x 24 cm Frameless Screening Paddle to test the Shifting Paddle function.

Table 10: Shifting Paddle

Function	Functional Test
Paddle Shift 	<p>The 18 x 24 cm Screening Paddle moves approximately 2.5 cm into the left, center, or right position. While compression is applied, you cannot move the paddle. The collimator is programmed to follow the position of the paddle.</p> <p>To test this function:</p> <ol style="list-style-type: none"> <li>1. Install the 18 x 24 cm paddle in the Compression Device.</li> <li>2. Select a view.</li> <li>3. Use the <b>Paddle Shift</b> buttons on the <i>Procedure</i> screen to override the position.</li> <li>4. Verify that the paddle automatically moves to the new position.</li> <li>5. Turn on the light field lamp.</li> <li>6. Confirm that the collimator position matches the paddle position.</li> <li>7. Repeat this procedure for the other paddle positions.</li> </ol>

## 4.3 Emergency Off Switches Functionality

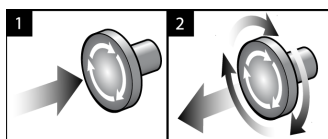


Figure 24: Emergency Off Switch Functionality

There are three Emergency Off switches, one on each side of the Gantry and one on the Acquisition Workstation.

1. To turn Off the Gantry and disable the Acquisition Workstation Lift Mechanism, press any of the Emergency Off switches.
2. To reset the Emergency Off switch, turn clockwise approximately one-quarter turn until the switch pops back out.

### 4.4 How to Turn Off the System

1. Close any open patient procedures. Refer to [Close a Patient](#) on page 68.
2. From the *Select Patient* screen, select the **Log Out** button.
3. From the *Startup* screen, select the **Shutdown** button.
4. Select **Yes** in the confirmation dialog box.

### 4.5 How to Remove All Power from the System

See the following figures for illustrations of the buttons and switches referenced in the following procedures.

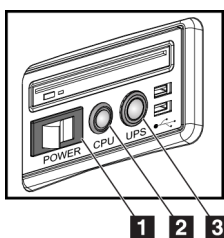


Figure 25: Universal Acquisition Workstation Power Buttons

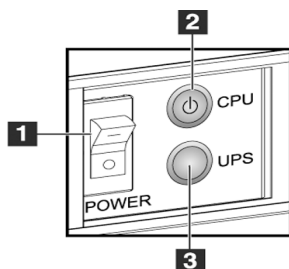


Figure 26: Premium Acquisition Workstation Power Buttons

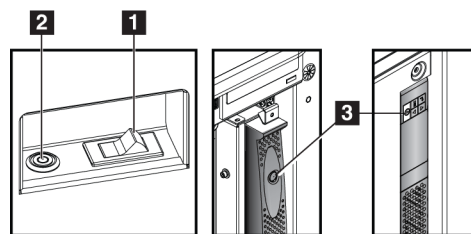


Figure 27: Standard Acquisition Workstation Power Buttons

#### Figure Legend

1. Acquisition Workstation Power Switch
2. Computer Power On/Reset Button
3. UPS (optional) Power Button

To remove all power from the system:

1. Turn off the system.
2. If your system includes the UPS, press the UPS button (item 3).
3. Turn OFF the Acquisition Workstation power switch (item 1).
4. Unplug the Acquisition Workstation power cable from the AC outlet.
5. Turn OFF the Gantry circuit breaker.
6. Turn OFF the Facility Mains circuit breaker.



## Chapter 5 User Interface

### 5.1 Select Function to Perform Screen

After login, the *Select Function to Perform* screen opens. This screen shows the quality control tasks that are due.



#### Note

The *Select Patient* screen opens when no quality control tasks are scheduled to be done.

Name	Last Performed	Due Date
DICOM Printer Quality Control		05/28/2014
Viewboxes and Viewing Conditions		05/28/2014
Diagnostic Review Workstation Quality Control		05/28/2014
Gain Calibration	05/14/2014	05/19/2014
CEDM Gain Calibration	05/13/2014	05/19/2014
Artifact Evaluation		05/28/2014
Phantom Image Quality		05/28/2014
SNR/CNR		05/28/2014
Compression Thickness Indicator		05/28/2014
Visual Checklist		05/28/2014
Compression Test		05/28/2014
Reject Analysis		05/28/2014
Repeat Analysis		05/28/2014

Figure 28: An Example Select Function to Perform Screen

#### To complete a scheduled Quality Control Task:

1. Select a Quality Control task from the list.
2. Select the **Start** button. Follow the messages to complete the procedure. (The **Start** button is not available for all types of tests.)  
- OR -  
Select the **Mark Completed** button to mark the status of this procedure as finished.  
Select **Yes** to confirm the selected procedure is completed.
3. Select **End QC**.

**To proceed without completing all scheduled Quality Control Tasks:**

If all Quality Control tasks are not completed at this time, select the **Skip** button.



**Note**

If you select the **Skip** button, the *Select Patient* screen opens. Refer to [Select Patient Screen](#) on page 52 for information about this screen.

If you select the **Admin** button, the *Admin* screen opens. Refer to [Admin Screen](#) on page 119 for information about this screen.



**Note**

Quality Control tasks are available to complete at any time. Select the **Admin** button then the **Quality Control** button to access the list of Quality Control tasks.

## 5.2 About the Taskbar

The taskbar at the bottom of the screen displays additional icons. Select the icon to access information or perform system tasks.

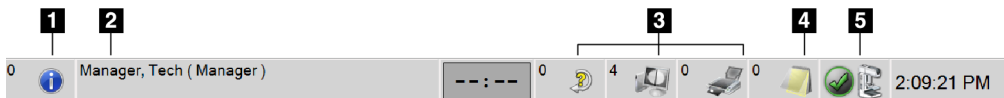


Figure 29: Taskbar

Table 11: Taskbar Menus


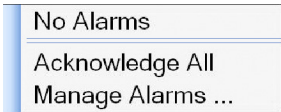


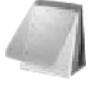

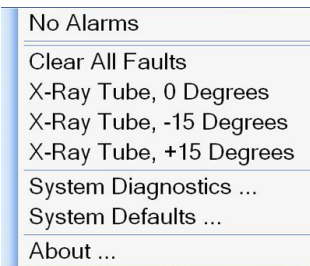
	Description	Menu
1 	<p><b>Information Icon</b></p> <p>Select the <b>Information</b> icon to display the Alarms menu.</p> <p>This section of the taskbar flashes a yellow color when an alarm exists.</p> <p>Select <b>Acknowledge All</b> to stop the flashing indication.</p> <p>Select <b>Manage Alarms</b> to display and close any open alarms.</p>	
2	<p><b>Current User Name</b></p> <p>Select the user name section of the taskbar to display the Users Menu.</p> <p><b>Log Out</b> returns you to the <i>Startup</i> screen.</p> <p><b>My Settings</b> lets you select user settings and workflow preferences.</p> <p><b>Print</b> sends the displayed patient list to a connected printer.</p>	

Table 11: Taskbar Menus

	Description	Menu
<p>3</p> 	<p align="center"><b>Output Device Icons</b></p> <p>Select any output device icon to display the <i>Manage Queues</i> screen. This screen displays the status of jobs in the queue, job information for the selected output, and allows you to filter the queue display. The number on the icon shows the number of jobs that remain in the queue.</p>	
<p>4</p> 	<p align="center"><b>Notices Icon</b></p> <p>Select the <b>Notices</b> icon to display the <i>Patients with Unviewed Notices</i> screen. The number on the icon shows the number of patients with Unviewed Notices.</p>	
<p>5</p> 	<p align="center"><b>System Status Icons</b></p> <p>If the <b>System Status (tubehead)</b> icon has a green check mark next to it, the system is ready for use. Select the <b>System Status</b> icon to display the Faults menu.</p> <p>If the <b>System Status</b> icon is red with a number next to it, the system needs to wait the number of minutes shown before the next image can safely be taken.</p> <p>If the <b>System Status</b> icon has a yellow exclamation mark next to it and this taskbar section flashes yellow, there is an error. Select the <b>System Status</b> icon for more information about the error.</p> <p><b>Clear All Faults</b> deletes all fault messages.</p> <p><b>X-ray Tube, 0 Degrees</b> puts the tubehead at zero degrees of rotation for the next exposure.</p> <p><b>X-ray Tube, -15 Degrees</b> puts the tubehead at -15 degrees of rotation for an exposure.</p> <p><b>X-ray Tube, +15 Degrees</b> puts the tubehead at +15 degrees of rotation for an exposure.</p> <p><b>System Diagnostics</b> accesses Subsystem settings.</p> <p><b>System Defaults</b> opens the <i>Gantry Defaults</i> screen to set the Compression and Generator default values.</p> <p><b>About</b> displays information about the Acquisition Workstation (refer to <a href="#">About Screen</a> on page 121).</p>	

### 5.3 Select Patient Screen

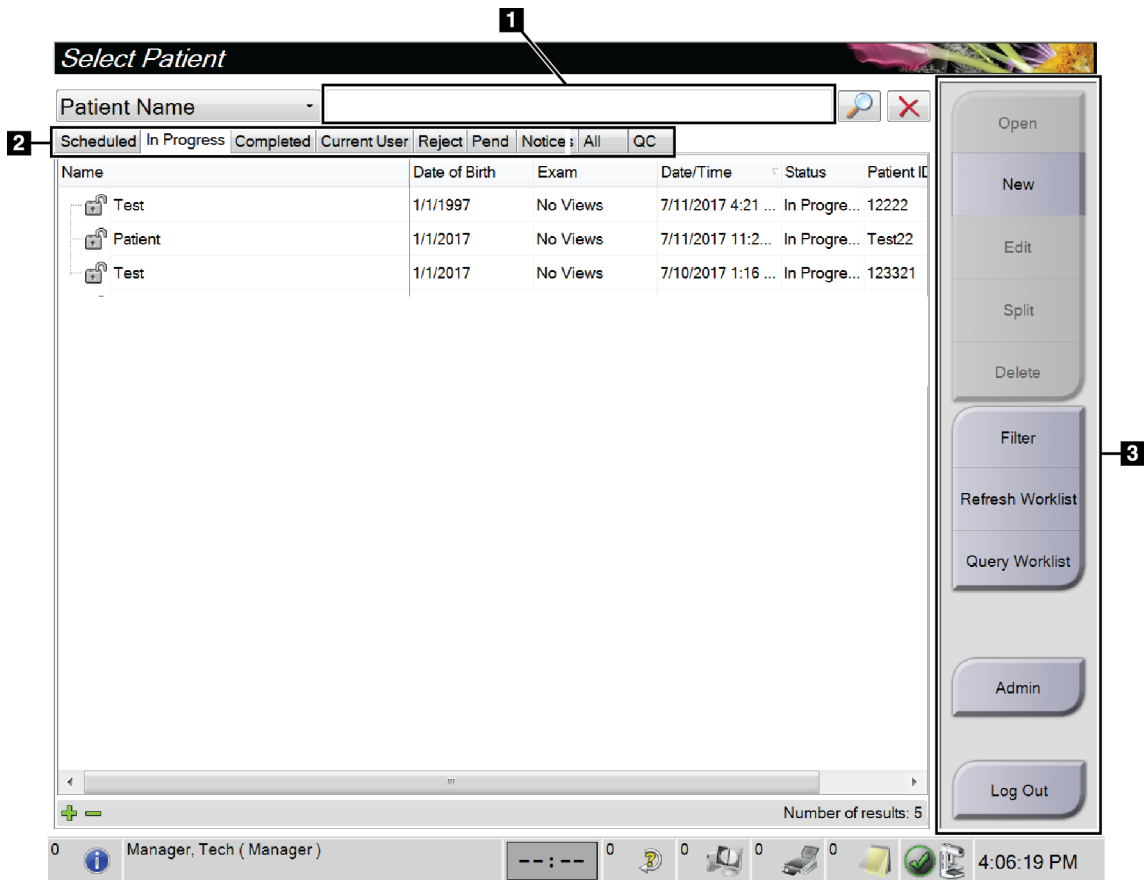
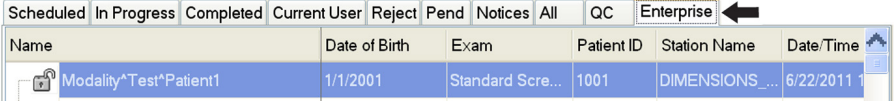


Figure 30: Select Patient Screen

Table 12: The Select Patient Screen

Item	Description
1. Quick Search	Search the selected tab for the Patient Name, Patient ID, or Accession Number.
2. Tabs	<p>The tabs at the top of the screen are configurable. A user with the correct permissions can delete tabs and create new tabs.</p> <ul style="list-style-type: none"> <li>• <b>Scheduled</b> tab shows the scheduled procedures.</li> <li>• <b>In Progress</b> tab shows the procedures not complete.</li> <li>• <b>Completed</b> tab shows the completed procedures.</li> <li>• <b>Current User</b> tab shows the procedures for the current operator.</li> <li>• <b>Reject</b> tab shows the procedures with rejected views.</li> <li>• <b>Pend</b> tab shows the procedures with pending views.</li> <li>• <b>All</b> tab shows all procedures for all users.</li> </ul>

Table 12: The Select Patient Screen

Item	Description
	<ul style="list-style-type: none"> <li>• <b>Notices</b> tab shows the patients with unviewed notices by default. Refer to <a href="#">About the Notices Tab</a> on page 53 for complete information.</li> <li>• <b>QC</b> tab shows the Quality Control procedures.</li> <li>• <b>Enterprise</b> tab is displayed if you have the <a href="#">Advanced Workflow Manager</a> on page 60. This tab shows a list of all studies acquired on systems within an Advanced Workflow Manager cluster. Distribution of the studies is managed from this tab.</li> </ul>  <p style="text-align: center;">Figure 31: Enterprise Tab</p>
<p><b>3. Buttons</b></p>	<p>Many functions are accessed from this screen by selecting a particular button:</p> <ul style="list-style-type: none"> <li>• <b>Open:</b> Open the selected patient.</li> <li>• <b>New:</b> Add a new patient — refer to <a href="#">Add a New Patient</a> on page 54.</li> <li>• <b>Edit:</b> Edit the patient information — refer to <a href="#">Edit the Patient Information</a> on page 54.</li> <li>• <b>Split:</b> Remove the images from a procedure or a patient and move the images to a different procedure or patient — refer to <a href="#">Split the Patient Records</a> on page 55.</li> <li>• <b>Delete:</b> Delete the selected patient — refer to <a href="#">Delete a Patient</a> on page 57.</li> <li>• <b>Filter:</b> Use a Patient Filter — refer to <a href="#">Filters for Patients</a> on page 57.</li> <li>• <b>Refresh Worklist:</b> Update the Scheduled Patient Worklist information — refer to <a href="#">Refresh the Worklist</a> on page 59.</li> <li>• <b>Query Worklist:</b> Search for a patient in the Modality Worklist — refer to <a href="#">Query the Worklist</a> on page 59.</li> <li>• <b>Admin:</b> Access the <i>Admin</i> Screen — refer to <a href="#">Admin Screen</a> on page 119.</li> <li>• <b>Log Out:</b> Exit the system — refer to <a href="#">Log Out</a> on page 59.</li> </ul>

### 5.3.1 About the Notices Tab

- After selecting the **Notices** tab from the *Select Patient* screen, a list of the Patients with Notices is shown.
- The default value for the list is patients with Viewed and Unviewed Notices.
- You can change the value to show patients with Viewed Notices or patients with Unviewed Notices.
- Select **Open** to access the *Procedure* screen for the selected patient.

### 5.3.2 Open a Patient

1. Select a tab to show the desired list of patients.
2. Select a patient from the list. The **Open** button becomes active.
3. Select **Open** to access the *Procedure* screen for that patient.

### 5.3.3 Add a New Patient

1. In the *Select Patient* screen, select the **New** button. The *Add Patient* screen opens.

The screenshot shows the 'Add Patient' screen with the following fields and options:

- Last: [Text Input]
- First: [Text Input]
- Middle: [Text Input]
- Patient ID\*: [Text Input]
- Date of Birth\*: [Date Picker]
- Gender\*: Female (Dropdown)
- Accession Number: [Text Input]
- Procedure\*: Conventional (Dropdown)
- Standard Screening - Conventional (Dropdown)

Buttons: Open, Back

Taskbar: Manager, Tech (Manager), 2:05:47 PM

Figure 32: Add Patient Screen

2. Enter the new patient information and select a procedure.
3. Select the **Open** button. The *Procedure* screen for the new patient opens.

### 5.3.4 Edit the Patient Information

1. In the *Select Patient* screen, select the patient name then select the **Edit** button.
2. In the *Edit Patient* screen, make changes then select the **Save** button.
3. Select **OK** to the *Update Successful* message.

### 5.3.5 Split the Patient Records

The Split function lets you move images when the images were acquired in an incorrect procedure or an incorrect patient.



#### Note

You cannot split images for protected patients.



#### Note

Archived patient records still need correction on PACS or other archive systems after using the Split function.

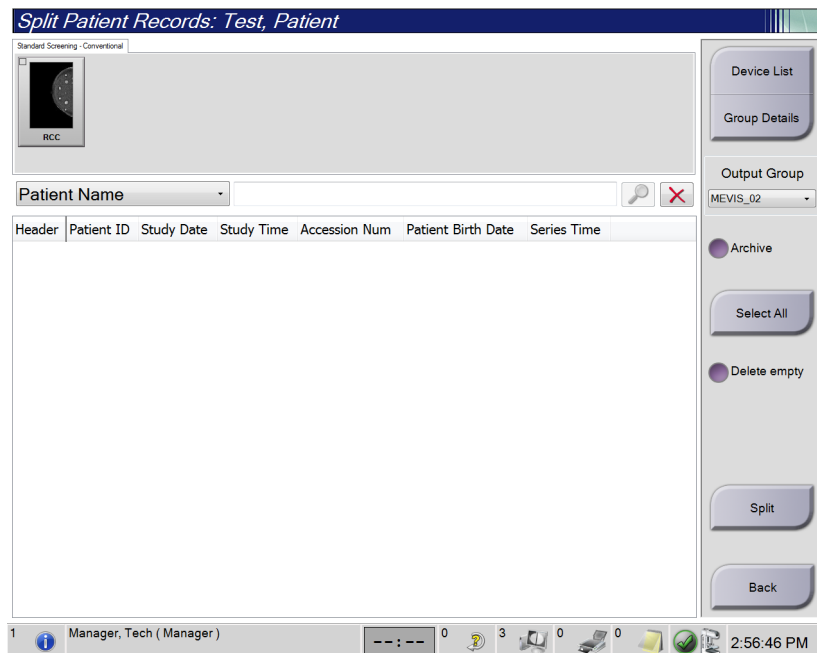


Figure 33: Split Patient Records Screen

#### Images Acquired in the Wrong Procedure

1. In the *Select Patient* screen, select the patient.
2. Select the **Split** button. The *Split Patient Records* screen opens.
3. Select the images to move. If all images are being moved, select **Select All**.
4. Select your search criteria (for example, Patient Name or Accession Number) using the drop-down list below the images.
5. Enter the same patient information and select the **Search** button (the magnifying glass).
6. When the Patient name appears, select the correct procedure for the images.

7. If ALL the images are being moved and you want to delete the incorrect procedure, select **Delete Empty**.
8. If you want to archive the images or save them to a stored device, select **Archive**. Verify that the correct outputs are selected.
9. Select **Split**, then select **OK** in the *Split Successful* message.

### Images Acquired in the Wrong Patient

1. In the *Select Patient* screen, select the patient that has the images that need to be moved.
2. Select the **Split** button. The *Split Patient Records* screen opens.
3. Select the images to move. If all images are being moved, select **Select All**.
4. Select your search criteria (for example, Patient Name or Accession Number) using the drop-down list below the images.
5. Enter the search criteria and select the **Search** button (the magnifying glass).
6. When the Patient name appears, select the correct procedure.

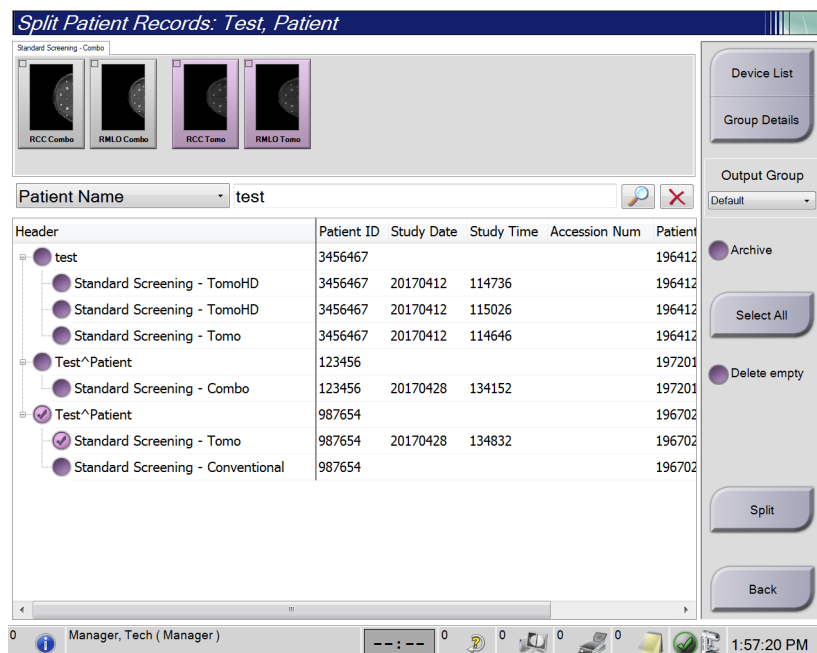


Figure 34: Select the Correct Procedure to Split Patient Records

7. If ALL images are being moved and you want to delete the incorrect patient from the Patient List, select **Delete Empty**.
8. If you want to archive the images or save them to a stored device, select **Archive**. Verify that the correct outputs are selected.
9. Select **Split**, then select **OK** in the *Split Successful* message.



### 5.3.6 Delete a Patient



#### Note

Reclamation normally removes the requirement to delete patients manually. Refer to [About Reclamation](#) on page 118.

1. In the *Select Patient* screen, select one or more patients.
2. Select the **Delete** button.
3. When the confirmation prompt is shown, select **Yes**.



#### Note

The Technologists do not have permissions to delete patients.

### 5.3.7 Filters for Patients

After selecting the **Filter** button in the *Select Patient* screen, the *Patient Filter* screen for the selected patient list opens.

Figure 35: Filter Tab in the Patient Filter Screen

**Filter Tab**

Use the **Filter** tab to change the filter options for the patient list. When you select or cancel an option, the change shows in the Results area of the screen.



**Note**

You must have Manager level access to save these new filters to the selected tab in the *Select Patient* screen. (Refer to [Other Functions of the Filter Tab](#) on page 58.)



**Note**

When you select a line in the results list then select the **Open** button, the *Procedure* screen for the selected patient opens.

**Other Functions of the Filter Tab**

The **Filter** tab allows users with access privileges to add, change, or delete tabs in the *Select Patient* screen. Refer to the following table.

*Table 13: Filter Tab Options (Require Access Privileges)*

<p>Change the current patient filter parameters.</p>	<ol style="list-style-type: none"> <li>1. Select a tab on the <i>Select Patient</i> screen.</li> <li>2. Select the <b>Filter</b> button.</li> <li>3. Select the filter options.</li> <li>4. Select the <b>Save</b> button.</li> <li>5. Make sure the name of the tab you selected is in the name box.</li> <li>6. Select <b>OK</b>.</li> </ol>
<p>Create a new tab for the <i>Select Patient</i> screen.</p>	<ol style="list-style-type: none"> <li>1. Select a tab on the <i>Select Patient</i> screen.</li> <li>2. Select the <b>Filter</b> button.</li> <li>3. Select the filter options for the tab.</li> <li>4. Select the <b>Save As</b> button.</li> <li>5. Enter a new name for the tab.</li> <li>6. Select <b>OK</b>.</li> </ol>
<p>Delete a tab from the <i>Select Patient</i> screen.</p>	<ol style="list-style-type: none"> <li>1. Select a tab on the <i>Select Patient</i> screen.</li> <li>2. Select the <b>Filter</b> button.</li> <li>3. Select the <b>Delete</b> button.</li> <li>4. Select <b>Yes</b> in the confirmation dialog box.</li> </ol>

### Columns Tab

Use the **Columns** tab to add more search options (for example, Age, Gender, Notices) to the filtered list. The options show as columns in the results area. To add more columns to a filtered list, select the **Columns** tab then select the options.



---

**Note**

You must have Manager level access to save these new columns to the patient filter.

---



---

**Note**

When you select a line in the results list then select the **Open** button, the *Procedure* screen for the selected patient opens.

---

### Order Tabs Button

Select the **Order Tabs** button to change the order of the patient list tabs.

#### 5.3.8 Refresh the Worklist

Select the **Refresh Worklist** button to update the Scheduled patient list from the Modality Worklist Provider.

#### 5.3.9 Query the Worklist

Select the **Query Worklist** button to search the Modality Worklist Provider for a patient or a list of patients.

There are two methods to enter the query information:

- **Keyboard**—Type the query information into one or more fields. The scheduled procedure is displayed, and the patient is added to the local database. All fields to query are configurable. The default fields are Patient name, Patient ID, Accession Number, Requested Procedure ID, and Scheduled Procedure Date.
- **Bar Code Scanner**—Scan the bar code for the configured query field. The scheduled procedure is displayed, and the patient is added to the local database. The field in which the bar code scanner scans is configurable. The default query field can be the Patient ID, Accession Number, or Requested Procedure ID.

#### 5.3.10 Admin

Select the **Admin** button to access the *Admin* screen and the system administration functions. Refer to [System Administration Interface](#) on page 119 for more information.

#### 5.3.11 Log Out

Select the **Log Out** button to exit the system and return to the *Startup* screen.

### 5.3.12 Advanced Workflow Manager

The Advanced Workflow Manager is a workflow engine that allows compatible Hologic systems to communicate and exchange images with each other. The Advanced Workflow Manager keeps track of all patients, procedures, and images acquired on all systems within an Advanced Workflow Manager cluster. In addition, the Advanced Workflow Manager synchronizes notices and provides images to all systems within the cluster.

Systems with Advanced Workflow Manager show the Enterprise tab on the [Select Patient Screen](#) on page 52. This tab lists the procedures acquired on all systems within an Advanced Workflow Manager cluster.

## 5.4 Procedure Screen

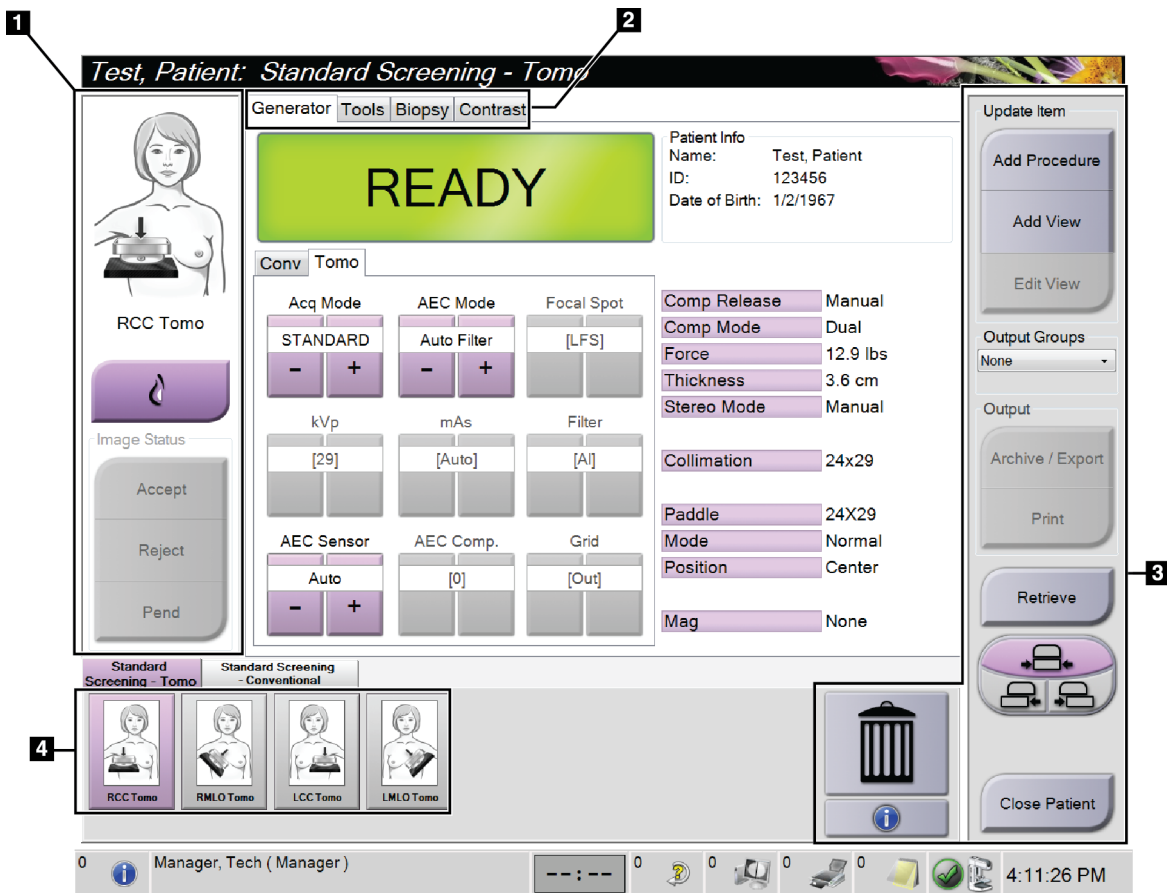


Figure 36: Procedure Screen

Table 14: The Procedure Screen

Item	Description
<p><b>1. Image Status</b></p>	<p>The view icon shows the current selected view.</p> <p><b>Implant Present</b> button—select when the patient has an implant.</p> <p><b>Accept</b> button—select to accept the image.</p> <p><b>Reject</b> button—select to reject the image.</p> <p><b>Pend</b> button—select to save the image for future review.</p>
<p><b>2. Tabs</b></p>	<p>Select the <b>Generator</b> tab to adjust the exposure techniques for the procedure.</p> <p>Select the <b>Tools</b> tab to review the images.</p> <p>Select the <b>Biopsy</b> tab to create targets.</p> <p>Select the <b>Contrast</b> tab to perform I-View™ 2D Contrast procedures.</p>
<p><b>3. Buttons</b></p>	<p>Many functions are accessed from this screen by selecting a particular button:</p> <p><b>Add Procedure:</b> Add a new patient.</p> <p><b>Add View:</b> Add a new view.</p> <p><b>Edit View:</b> Assign a different view to an image.</p> <p><b>Archive/Export:</b> Send images to an output.</p> <p><b>Print:</b> Print images.</p> <p><b>Retrieve:</b> Query the configured devices with the current patient information.</p> <p><b>Paddle Shift:</b> Bypass the default paddle position for the selected view.</p> <p><b>Close Patient:</b> Exit the patient and procedure.</p> <p><b>Trash Can:</b> Delete a view.</p>
<p><b>4. Thumbnails</b></p>	<p>Select a tab to show the thumbnail views or the thumbnail images for that procedure.</p>

### 5.4.1 How to Use the Implant Present Button

The **Implant Present** button is above the **Accept** button on the *Procedure* screen. This button applies special implant processing to the implant and implant displaced views, and changes the "Implant Present" DICOM tag in the image header. When this button is selected, a check mark appears on the button.



Select the **Implant Present** button for both implant and implant displaced views before you acquire the image.



---

**Note**

The **Implant Present** button is automatically selected if any procedure tabs contain an ID view.

---

### 5.4.2 How to Use the Paddle Shift Feature

Refer to [Paddle Shift](#) on page 100 for information about the Paddle Shift feature.

1. In the *Procedure* screen, select an unexposed thumbnail image view. The paddle moves to the default position for that view.
2. Select a paddle shift button to bypass the default paddle position for the selected view. The paddle moves to the new position.

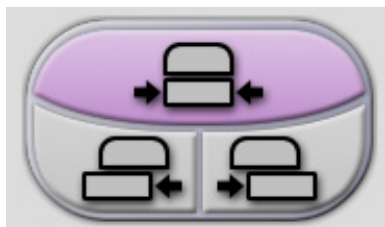


Figure 37: Paddle Shift Buttons

### 5.4.3 Procedure Information Dialog Box

To show procedure information, select the **Procedure Information** button located below the **Delete View** (trash can) button. The Procedure Info dialog box displays with the following information:

- Procedure Name
- Accession Number
- Procedure Status
- Procedure Start and End Date and Time
- Dose Information (each Breast and Cumulative)

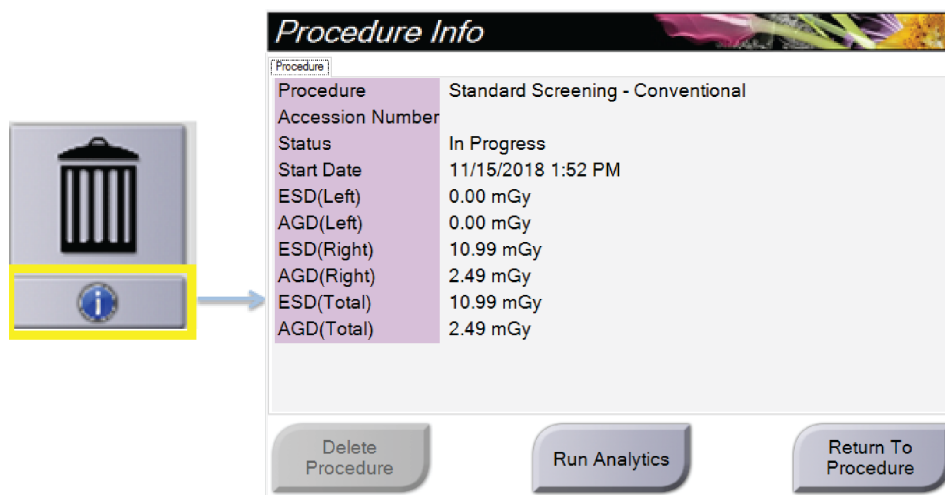


Figure 38: Procedure Info Dialog Box

For procedures that contain no exposed views, select the **Delete Procedure** button to remove the selected procedure from the patient.

To run the image analytics manually, select the **Run Analytics** button.



#### Note

The **Run Analytics** button only shows if you have a license for ImageChecker® CAD or Quantra™ software.

Select **Return to Procedure** to exit the dialog box.

#### About the Run Analytics Button

ImageChecker® CAD and Quantra™ volumetric breast density assessment software are available on the Selenia Dimensions and 3Dimensions systems.

When you are licensed for one of these features:

- Image analytics are run automatically when you select the **Close Procedure Complete** button to close a patient after acquiring new images. Image analytics are run automatically after editing a patient, editing a view, or adding a view when you select the **Close Procedure Complete** button to close a patient.
- Image analytics can be run manually by selecting the **Run Analytics** button in the Procedure Info dialog box. Run image analytics manually as needed on images that are received or imported from an external source.
- Image analytics run only on images that were acquired using the same software version as the Acquisition Workstation.
- The Procedure Info dialog box includes tabs that show the success or failure status of the image analytics.
- Thumbnail images for the image analytics results are displayed in the thumbnail image section of the *Procedure* screen.



### 5.4.4 Add a Procedure

1. To add another procedure, select the **Add Procedure** button on the *Procedure* screen to access the Add Procedure dialog box.

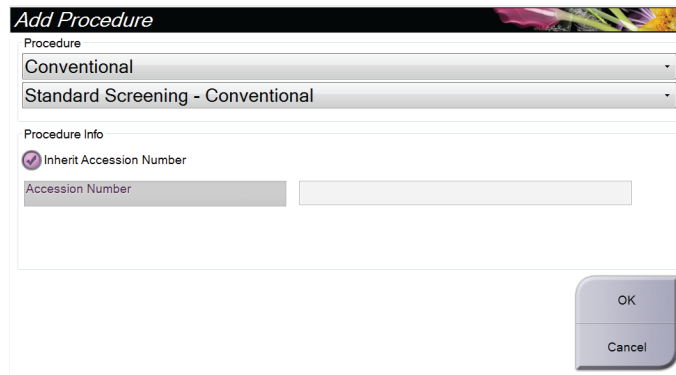


Figure 39: Add Procedure Dialog Box

2. Use the drop-down menus to select the type of procedure to add.
3. The current Accession Number is automatically used. To use a different Accession Number, deselect the "Inherit Accession Number" check box and enter the desired number.
4. Select the **OK** button. A new tab is added with the thumbnail views for the procedure that was selected.

### Available Procedures

The table that follows shows the major groups of procedures that are available on the system.



**Note**

Some procedures in the list show only when the system is licensed for that procedure.

Table 15: Procedure Groups

Procedure	Description
Conventional	Digital mammography (2D) imaging only
Combo	Digital mammography (2D) and breast tomosynthesis imaging
Tomo	Breast tomosynthesis imaging only
TomoHD	Breast tomosynthesis imaging and a generated 2D image
ComboHD	Digital mammography (2D) and breast tomosynthesis imaging and a generated 2D image
Stereo Biopsy	Biopsy that uses stereotactic targeting
Tomo Guided Biopsy	Biopsy that uses tomosynthesis targeting
Specimen	Specialized specimen imaging
2D Contrast	Contrast enhanced digital imaging

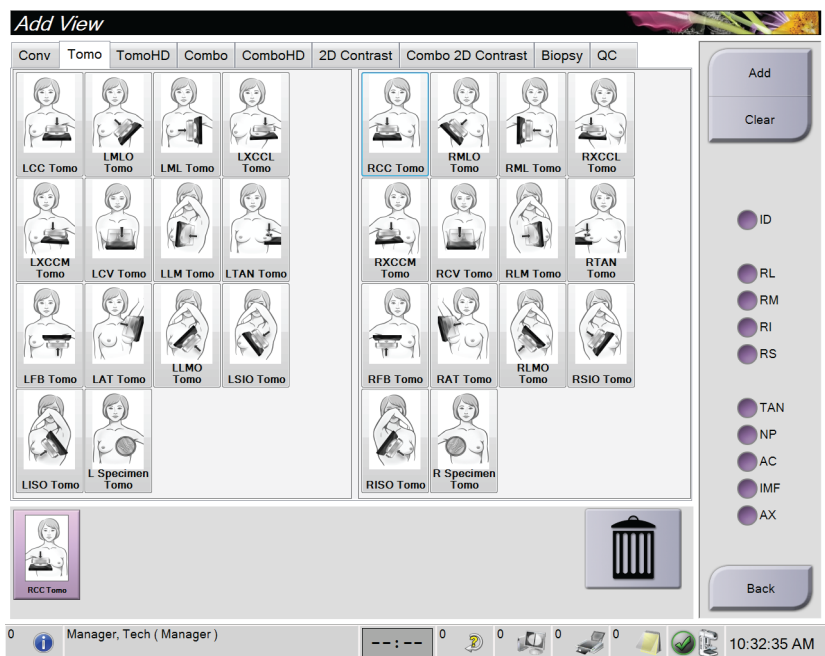
### 5.4.5 Add (or Remove) a View

#### To Add a View

1. Select the **Add View** button to access the *Add View* screen.

**Note**

Depending on the license settings for your system, you may see different tabs.



#### View Modifiers

- ID = Implant Displaced
- RL = Rolled Lateral
- RM = Rolled Medial
- RI = Rolled Inferior
- RS = Rolled Superior
- TAN = Tangential
- NP = Nipple in Profile
- AC = Anterior Compression
- IMF = Infra-Mammary Fold
- AX = Axillary Tissue

Figure 40: Add View Screen

2. Select the tab, then select the view. You can select a maximum of three View Modifiers from the right panel of the screen.
3. Select the **Add** button. A thumbnail image of each selected view is added in the bottom panel of the screen.

#### To Remove a View

- To remove a single view from the added list: select the view then select the trash can icon.
- To remove all views from the added list: select the **Clear** button.

### 5.4.6 Edit a View

Use the *Edit View* screen to assign a different view to an image.

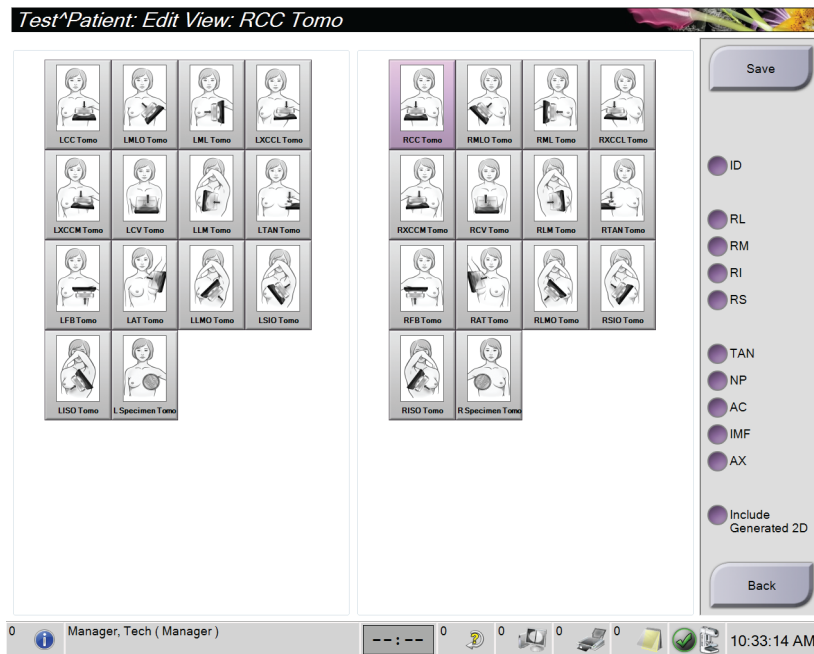


Figure 41: Edit View Screen

1. In the *Procedure* screen, select an exposed thumbnail image view.
2. Select the **Edit View** button.
3. Select the view from the screen. You can select a maximum of three View Modifiers. See the figure [The Add View Screen](#) on page 66 for a description of the View Modifiers.
4. Select **Save**, then select **OK** to the *Update Successful* message.



#### Note

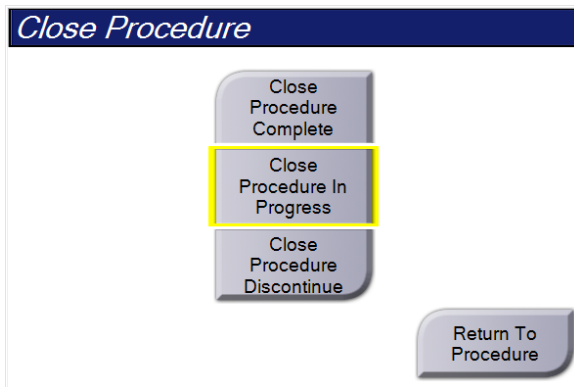
The *Edit View* screen for biopsy procedures shows different View Modifiers. Refer to the Affirm® breast biopsy guidance system *User Guide*.

### 5.4.7 Retrieve

Select the **Retrieve** button to query the configured devices with the current patient information. The **Retrieve** button performs the same function as the **Query Retrieve** button in the *Admin* screen.

### 5.4.8 Close a Patient

Select the **Close Patient** button. If images were acquired, the Close Procedure dialog box opens. Select one of the following options:



**Close Procedure Complete:** Closes the procedure and puts the procedure in the **Completed** tab.

**Close Procedure In Progress:** Closes the procedure and puts the procedure in the **In Progress** tab.

**Close Procedure Discontinue:** Closes the procedure and puts the procedure in the **All** tab. A dialog box opens and you must select the reason the procedure was discontinued from a list or add a new reason.

**Return To Procedure:** Returns to the procedure.

If there are images marked as Pend, a dialog box opens with the following options:

- Accept All and Close Complete
- Close Procedure In Progress
- Return to Procedure

If MPPS is activated, procedure status information is sent to the output devices when you select **Complete** or **Discontinue**. You can also click and hold the tab above the thumbnail images to resend a message about the procedure status during the procedure. A Procedure Action dialog box opens with buttons to resend a status or to return to the procedure.



#### Note

When you are licensed for ImageChecker® CAD or Quantra™ software, image analytics are run automatically when you select the **Close Procedure Complete** button after acquiring new images. The results are automatically sent to the Output Devices. When you reopen the patient, thumbnail images for the results are displayed in the *Procedure* screen and status tabs are available in the Procedure Info dialog box.

## 5.5 How to Access the Image Review Features

Select the **Tools** tab on the *Procedure* screen to access the image review features. Refer to [Image Review Tools Tab](#) on page 81 for information.

## 5.6 Output Groups

The accepted images are sent automatically to the output devices in the selected Output Group. The system configuration controls if the images are sent after a patient is closed or after the image is accepted.



---

**Note**

Tomosynthesis images are not sent to a print device in the selected Output Group. You can print selected tomosynthesis images from the *Print* screen.

---

### 5.6.1 Select an Output Group

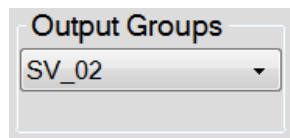


Figure 42: Output Groups Field

Select an output device group like PACS, Diagnostic Workstations, CAD devices and printers from the Output Groups drop-down list in the *Procedure* screen.



---

**Note**

Images are not sent if an Output Group is not selected.

---

### 5.6.2 Add or Edit an Output Group



---

**Note**

The configuration of Output Groups occurs during installation, but you can edit existing groups or add new groups.

---

**To add a new Output Group:**

1. Access the *Admin* screen.
2. Select the **Manage Output Groups** button.
3. Select the **New** button, enter the information, then select the output device(s).
4. Select **Add**, then select **OK** in the *Update Successful* message.
5. You can select any group to set as the default.

**To edit an Output Group:**

1. Access the *Admin* screen.
2. Select the **Manage Output Groups** button.
3. Select the **Edit** button, then make the changes.
4. Select **Save**, then select **OK** in the *Update Successful* message.

### 5.6.3 Custom Output

The Custom Output Group option lets you make an output group from the *Procedure* screen. The custom output group that you make stays as the Custom option until another custom output group is made.

**To make a Custom Output Group from the *Procedure* screen:**

1. In the *Procedure* screen, select **Custom** from the Output Groups drop-down list.
2. In the *Output Group* dialog box, select from the list of available devices, then select **OK**.

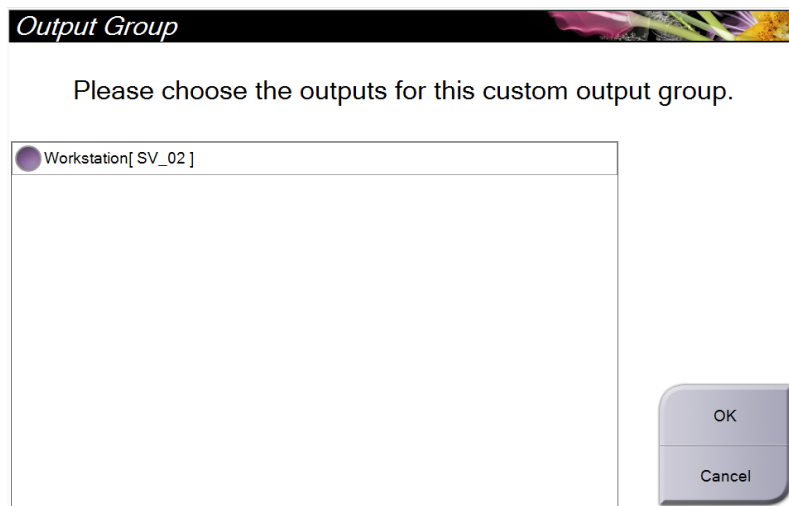


Figure 43: An Example Custom Output Group

## 5.7 On-Demand Outputs

The On-Demand Outputs are **Archive/Export** or **Print**. You can manually Archive, Export, or Print the currently opened patient until the procedure is closed.

When you select an **On-Demand Output** button, you have the option to send images from the patient that is open to any of the configured output devices.

### 5.7.1 Archive

1. Select the **Archive/Export** button.
2. Select the procedure or views in the *On Demand Archive* screen:
  - **Select All** button selects all items that show in this screen.
  - **Clear** button deselects items that are selected in this screen.
  - **Priors** button shows previous procedures and views for this patient.
  - **Rejected** button shows rejected views for this patient.
3. Select a storage device:
  - Select the **Device List** button and make your selection from the options in the *Storage Device* drop-down menu.

-OR-

  - Select an output group from the *Output Group* drop-down list.
4. Select the **Archive** button to send the selected images to the selected archive.



#### Note

Use the Manage Queue utility in the taskbar to review the archive status.

---

### 5.7.2 Export

1. Select the **Archive/Export** button (on the right side of the *Procedure* screen).
2. Select the images to export, then select the **Export** button.

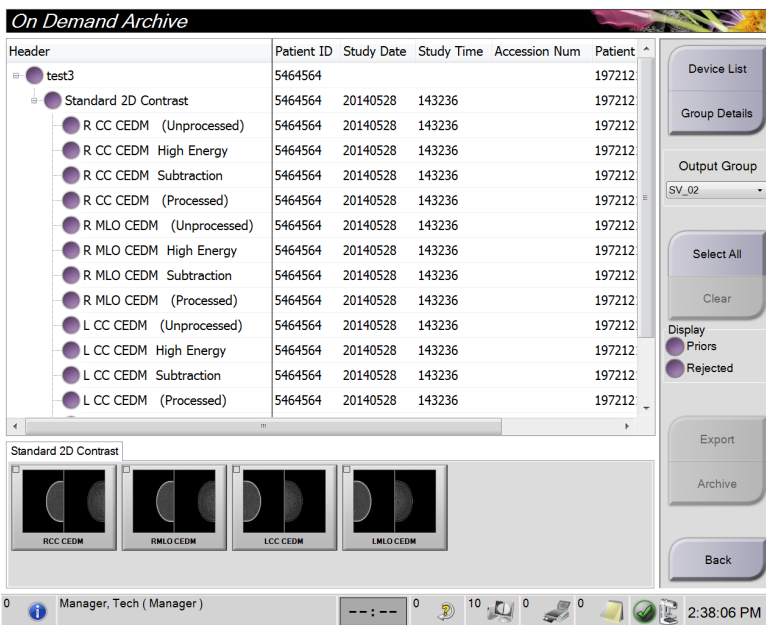


Figure 44: Select the Images for Export

3. In the Export dialog box, select the target from the drop-down list of media devices.



Figure 45: Export Dialog Box

- To anonymize patient data, select **Anonymize**
  - To automatically eject the removable media storage device when the export is complete, select **Eject USB device after write**.
4. To select a folder on your local systems for storage of your selections and to select the Export Type for the image, select **Advanced**. Select the **Start** button to send the selected images to the selected device.



### 5.7.3 Print

1. From the *Procedure* screen, select the **Print** button to show the *Print* screen. See the figure [The Print Screen](#) on page 74 to prepare your print data.
2. Select the film format from the film format area of the screen.
3. Select a thumbnail image.
4. Select the image mode (Conventional, Projection, or Reconstruction). The C-View button shows if the system is licensed for C-View imaging.
5. Select the print preview area (item 16) in the *Print* screen. The image that shows in this area is the image that prints on the film.
6. To put other images on the same multiformat film, repeat steps 3 through 5.
7. To print a different film format of the same images, select the **New Film** button (item 12), then complete steps 2 through 6.
8. Use the buttons in the top left area of the *Print* screen (item 1 through item 6) to hide or show patient data, markings and annotations, and to change the orientation of the image.
9. Select the **Print** button to print your films.

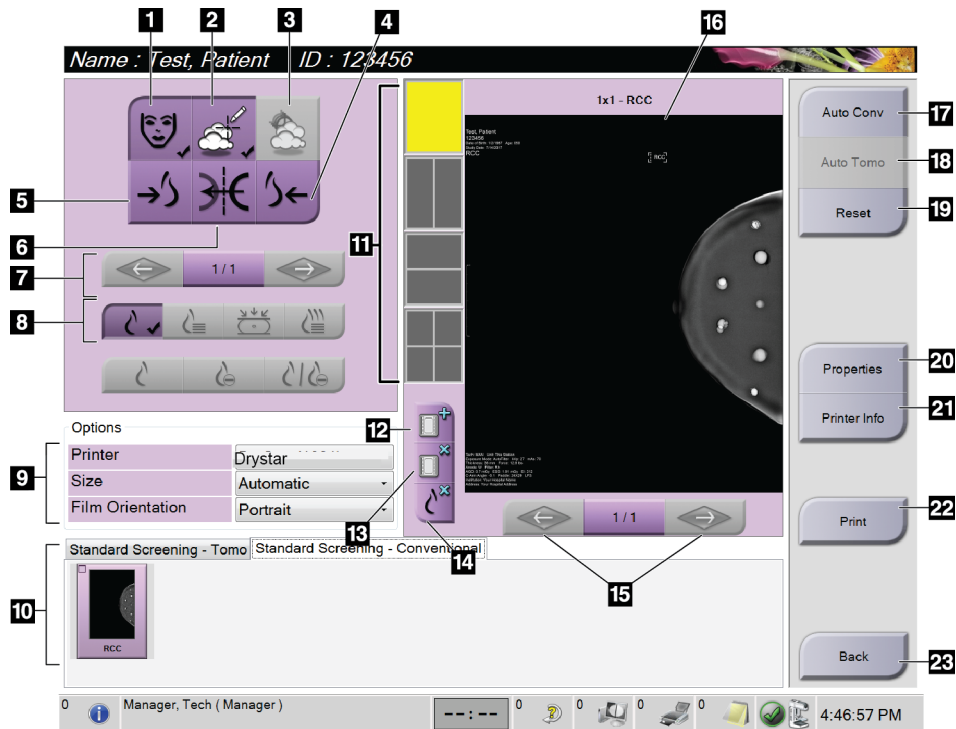


Figure 46: Print Screen

### Figure Legend

- |  |   |
|--|---|
| <ol style="list-style-type: none"> <li>1. Show or hide patient data.</li> <li>2. Show or hide markings and annotations.</li> <li>3. Show or hide targets in images from a biopsy.</li> <li>4. Print the image from a dorsal perspective.</li> <li>5. Print the image from a ventral perspective.</li> <li>6. Reverse (mirror) the image.</li> <li>7. Go to previous or next tomosynthesis slice or projection (Tomosynthesis option).</li> <li>8. Select Conventional, Projection, or Reconstruction views (Tomosynthesis option). The C-View button shows if the system is licensed for C-View imaging.</li> <li>9. Select the printer options.</li> <li>10. View Thumbnail images.</li> <li>11. Select the film format (number of tiles).</li> <li>12. Create a new film.</li> </ol> | <ol style="list-style-type: none"> <li>13. Delete a film.</li> <li>14. Delete an image from a film.</li> <li>15. Step through the film pages.</li> <li>16. Print preview area.</li> <li>17. Print Conventional (and C-View images, if system is licensed) with the default setup.</li> <li>18. Print tomosynthesis images (slices or projections) Tagged for Print (Tomosynthesis option).</li> <li>19. Return the <i>Print</i> screen to default settings.</li> <li>20. Open the <i>Properties</i> screen.</li> <li>21. Show the printer IP address, AE Title, Port and capability for True Size print.</li> <li>22. Start the print process.</li> <li>23. Return to the <i>Procedure</i> screen.</li> </ol> |
|--|---|

## Chapter 6 Images

### 6.1 Image Display Screen

After you make an exposure, the acquired image opens on the Image Display monitor. Patient and procedure information can be displayed on the screen. To turn the information on or off, go to the **Tools** tab in the *Procedure* screen and select the **Patient Information** button.



Figure 47: Image Display Screen

#### Figure Legend

1. Patient information and exam date
2. Exposure information, including:
  - Exposure techniques
  - Patient dose
  - C-arm angle
  - Compression thickness and force
  - Facility and technologist information

## 6.2 How to Set the Exposure Parameters

### 6.2.1 Select the Image Acquisition Mode (Tomosynthesis Option)

- Standard For routine Tomosynthesis screening procedures
- Enhanced For diagnostic Tomosynthesis views



**Warning:**

**Enhanced acquisition mode with combo mode imaging (DM + BT) can produce radiation dose that is higher than the MQSA screening limit of 3.0 mGy and therefore should only be used in diagnostic evaluation.**

---

### 6.2.2 Select the Exposure Mode

Use the Automatic Exposure Control modes (AEC) to let the system control the exposure techniques. AEC modes are available from 20-49 kV.

- Manual The user selects the kV, mAs, Focal Spot, and Filter.
- AEC: Auto-Time The user selects the kV, Focal Spot, and Filter. The system selects the mAs.
- AEC: Auto-kV The user selects the Focal Spot. The system selects the kV, mAs, and Filter (Rhodium).
- AEC: Auto-Filter The user selects the Focal Spot. The system selects the kV, mAs, and Filter.

### 6.2.3 How to Use the AEC Sensor

The AEC Sensor has seven manual positions and an automatic position. The manual positions start at the chest wall edge (position 1) and reach toward the nipple edge (position 7). The automatic position selects two regions within an area that extends from the chest wall to the nipple.

Use the plus (+) and minus (-) keys on the Compression Device or in the AEC Sensor area of the screen to change the sensor position. You can select Auto AEC to allow the system to calculate the best exposure for the breast.

## 6.3 How to Acquire an Image

Refer to [Clinical Procedures](#) on page 107 for information about clinical procedures.

1. Select a view from the thumbnail views at the bottom of the *Procedure* screen.
2. Press and hold the **x-ray** button and/or the **x-ray footswitch** for the full exposure.

During the exposure:

- The System Status bar shows the radiation symbol and a yellow background (see the following figure).

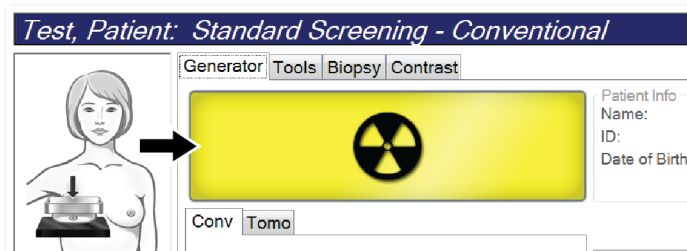


Figure 48: Exposure In Progress

- An audible tone continues to sound during the exposure  
The audible tone is a continuous sequence of tones. The tone sounds during the entire combo acquisition from the initiation of the exposure to the end of the conventional view. There is no interruption of the audible tone between breast tomosynthesis and conventional digital mammography exposures. Do not release the exposure switch during the audible tone.
3. When the tone stops and the System Status bar shows **Standby** (see the following figure), release the **x-ray** button and/or the **x-ray footswitch**.

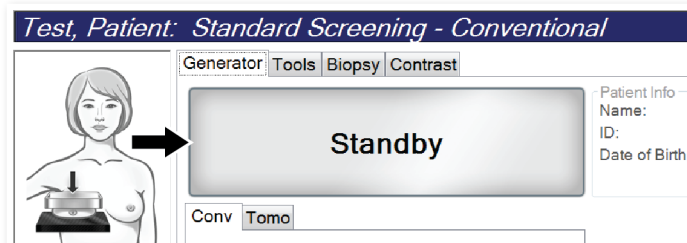


Figure 49: Exposure Complete

- When the x-ray is finished, the image appears on the Image Display monitor. The *Procedure* screen automatically changes to the **Tools** tab.

Select one of the following options to complete the acquisition:

- Accept** the image. The image transmits to output devices with all attributes.
- Reject** the image. When the dialog box opens, select the reason for rejecting the image. The *Image Display* screen closes. You can repeat the rejected view, or select another view. If you select **Reject**, an "X" appears on the thumbnail image.
- Pend** the image. The image saves for future review. If you select **Pend**, a question mark "?" appears on the thumbnail image.



Figure 50: Marked Images in a Procedure

- Repeat steps 1 through 4 for each view.



### Note

A manager user can configure the system to Auto-Accept or Auto-Pend new images.

---

## 6.3.1 Conventional Imaging Sequence of Events

- Review the image after the exposure and add a comment, if necessary.
- Accept**, **Reject**, or **Pend** the image. A thumbnail image replaces the thumbnail view in the Case Study area of the screen.



### Note

A manager user can configure the system to Auto-Accept or Auto-Pend new images.

---

## 6.3.2 Tomosynthesis Imaging Sequence of Events

- Wait for the image reconstruction to complete.
- Review the projection images for motion.
- Accept**, **Reject**, or **Pend** the images. A thumbnail image replaces the thumbnail view in the Case Study area of the screen.



### Note

A manager user can configure the system to Auto-Accept or Auto-Pend new images.

---

### 6.3.3 How to Accept a Rejected Image

If a rejected image is better than the new image, you can retrieve and use the old image. Select the thumbnail image on the *Procedure* screen to review the image, then **Accept** the image.

### 6.3.4 How to Accept or Reject a Pended Image

To accept or reject a Pended image, select the Pended thumbnail image, then select the **Accept** button or the **Reject** button.



---

**Note**

A manager user can configure the system to Auto-Accept or Auto-Pend new images.

---

## 6.4 How to Correct and Reprocess Implant Images

You must correct the image if you acquire an implant or an implant displaced view without the **Implant Present** button activated.

### 6.4.1 If the Image Is Not Accepted

Select the **Implant Present** button on the *Procedure* screen to indicate an implant exists. A check mark appears on the button and the image reprocesses.



### 6.4.2 If the Image Is Accepted

1. Select the image.
2. Select the **Implant Present** button on the *Procedure* screen to correct the image. A check mark appears on the button and the image reprocesses.
3. Select the **Accept** button to accept the changes.



---

**Note**

The corrected image is sent automatically to the selected output devices if the system is set to send images when the **Accept** button is selected.

---

## 6.5 How to Review the Images

Review of the images involves use of the thumbnails, image review tools, and display modes.

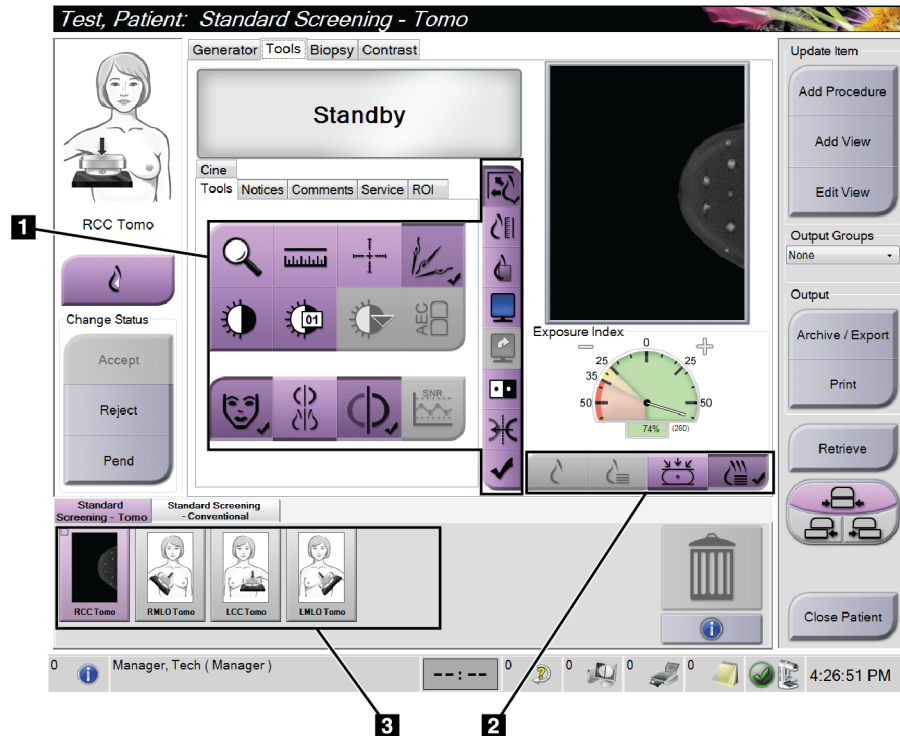


Figure 51: Tools Tab (Tomosynthesis option shown)

### Figure Legend

1. Image Review Tools - refer to [Image Review Tools Tab](#) on page 81.
2. Image Display Modes - refer to [Display Modes](#) on page 83.
3. Thumbnail Views and Thumbnail Images. Select any thumbnail image to display that image on the Image Display monitor.



### 6.5.1 Image Review Tools Tab

The **Tools** tab in the *Procedure* screen provides the image review tools. A check mark appears on an active tool.

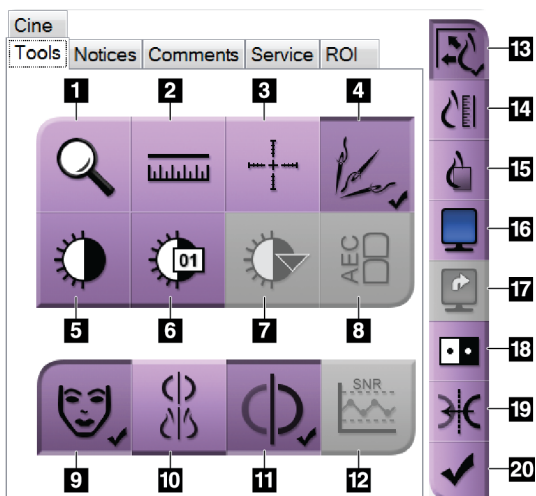


Figure 52: Image Review Tools

#### Figure Legend

1. The **Zoom** tool magnifies a section of the image.
2. The **Ruler** tool measures the distance between two points.
3. The **Crosshair** tool displays a crosshair on the *Image Display* screen.
4. The **Demetalizer** tool for processing tomosynthesis images that contain metal objects.
5. The **Window/Level** tool changes the brightness and contrast.
6. The **Window/Level Fine Adjustment** tool allows the entry of specific window and level values.
7. The **LUT Selection** tool scrolls through available Window/Level settings for a displayed image with LUTs attached.
8. The **AEC** button displays the AEC Sensor areas used for the exposure calculation. The sensor areas display on the *Image Display* screen.
9. The **Patient Information** button activates the patient information display.
10. The **Auto-Hanging** button automatically hangs the currently selected study in a 4-up configuration.
11. The **Auto-Pairing** button turns off auto-pairing for the currently selected image in a multi-up configuration.
12. The **SNR/CNR** button calculates the signal-to-noise ratio and contrast-to-noise ratio on the ACR Phantom.
13. The **Fit-to-Viewport** button fits the image within the image tile.
14. The **True Size** button displays the image in the actual size of the breast.
15. The **View Actual Pixels** button displays the image in full resolution.
16. The **Multi-Up Display** button selects the number of tiles to display.
17. The **Image Tile Advance** button sets the active Multi-Up tile.
18. The **Invert Image** tool changes blacks to whites and whites to black.
19. The **Mirror** button reverses (mirrors) the image.
20. The **Tag for Print** button tags the projection or reconstruction images of a tomosynthesis image to print later.

### 6.5.2 Notices Tab

The tools on the **Notices** tab allow you to mark and annotate images and send notices about the displayed image or procedure. The Notice Output Groups drop-down menu at the bottom of the tab allows you to select the destination for the Notices.

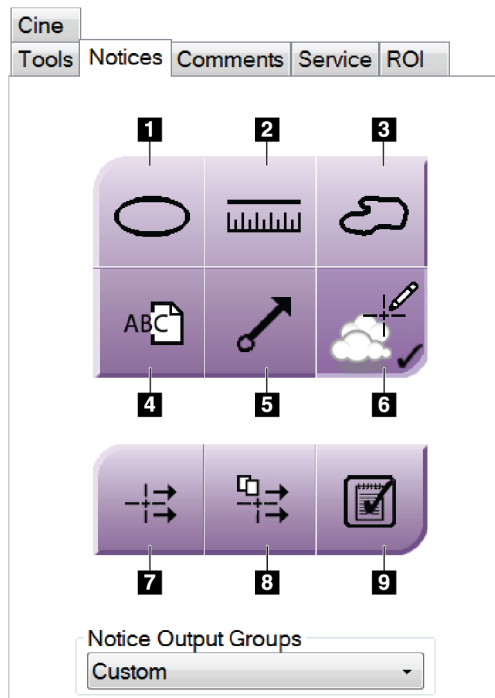


Figure 53: Tools on the Notices Tab

#### Figure Legend

1. The **Oval** tool draws an oval marking on the image.
2. The **Ruler** tool measures the distance between two points.
3. The **Freehand** tool draws a freehand marking on the image.
4. The **Text** tool adds a text note to the image without a marking.
5. The **Arrow** tool draws an arrow marking on the image.
6. The **Markings** tool shows or hides markings and annotations on an image.
7. The **Send Notice** tool sends a notice for the current image to the selected destination.
8. The **Send All Notices** tool sends all notices for all images in the opened procedure to the selected destination.
9. The **Viewed** tool changes the Patient Notices status to viewed.

### 6.5.3 Other Image Review Tools

#### Other Tabs

- **Comments:** Add comments to an image.
- **Service:** Mark an image for service use.
- **ROI:** Draw a Region of Interest on the Image Display monitor.
- **Cine:** Show a series of images as a movie (Tomosynthesis option).

#### Exposure Index

The Exposure Index is an image quality guide. When the Exposure Index indicates the red or yellow area, review the selected image for noise and decide whether to reacquire the image.

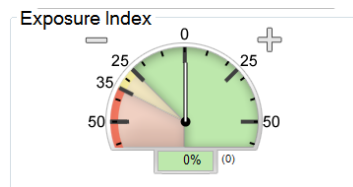


Figure 54: Exposure Index

#### Display Modes

Use the buttons in the Display Modes area of the screen to select the type of view to show on the Image Display monitor. You can change between conventional, generated 2D, projections, and reconstructions to show the combination images.

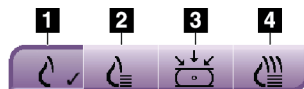


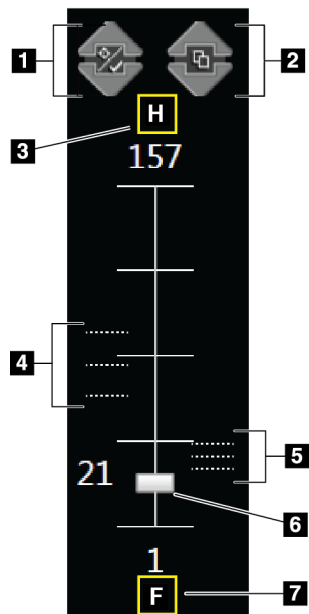
Figure 55: Display Modes

#### Figure Legend

1. **Conventional** button shows conventional images.
2. **Generated 2D** button shows a conventional 2D image generated from the acquired tomographic image.
3. **Projections** button shows the 15° projection images.
4. **Reconstructions** button shows reconstructed slices.

### 6.5.4 Slice Indicator

The tomosynthesis Slice Indicator on the Image Display monitor shows only on tomographic reconstructions.



**Figure Legend**

1. **Up** and **Down** arrows let you change between slices that contain a lesion target and slices that are tagged for printing.
2. **Up** and **Down** arrows let you change between slices that contain notices.
3. "H" (anatomical reference to head direction)
4. Slices that contain targets or are tagged for printing.
5. Slices that contain notices.
6. Scroll bar moves through the slices of the reconstruction.
7. "F" (anatomical reference to foot direction)

Figure 56: Tomosynthesis  
Slice Indicator

### 6.6 How to Send the Images to the Output Devices

You can send the images to output devices or use the Archive/Export function to copy images to temporary storage media. Refer to [Output Groups](#) on page 69 and [On-Demand Outputs](#) on page 71 for instructions.

## 6.7 How to Use I-View 2D Contrast



### Note

Hologic configures some systems to meet specific requirements. Your system configuration may not have all the options and accessories included in this manual.

1. Select the **Contrast** tab to access the I-View™ 2D Contrast (CEDM) function.



Figure 57: I-View 2D Contrast Screen

2. Set the contrast settings. For more information, refer to [How to Configure the Contrast Settings](#) on page 88.



### Note

Contrast information is included in the DICOM header of I-View images.

- To begin the contrast dose and start the timer, select the **Start** (arrow) button.  
The timer begins in the **Waiting Period**, which appears with a yellow background.



### Note

You can adjust the default length of time for the **Waiting Period** and **Optimal Imaging Period** phases of the timer. Refer to [Set the Contrast Defaults](#) on page 128.



Figure 58: I-View 2D Contrast Screen, Waiting Period



### Note

The timer function does not allow you to stop the timer, only to start and reset it. The timer stops only when you exit the patient procedure.

After the **Waiting Period**, the timer begins the **Optimal Imaging Period**, which appears with a green background.

4. Acquire the images during the **Optimal Imaging Period**.  
After you acquire an image, a marker will appear below the timer.

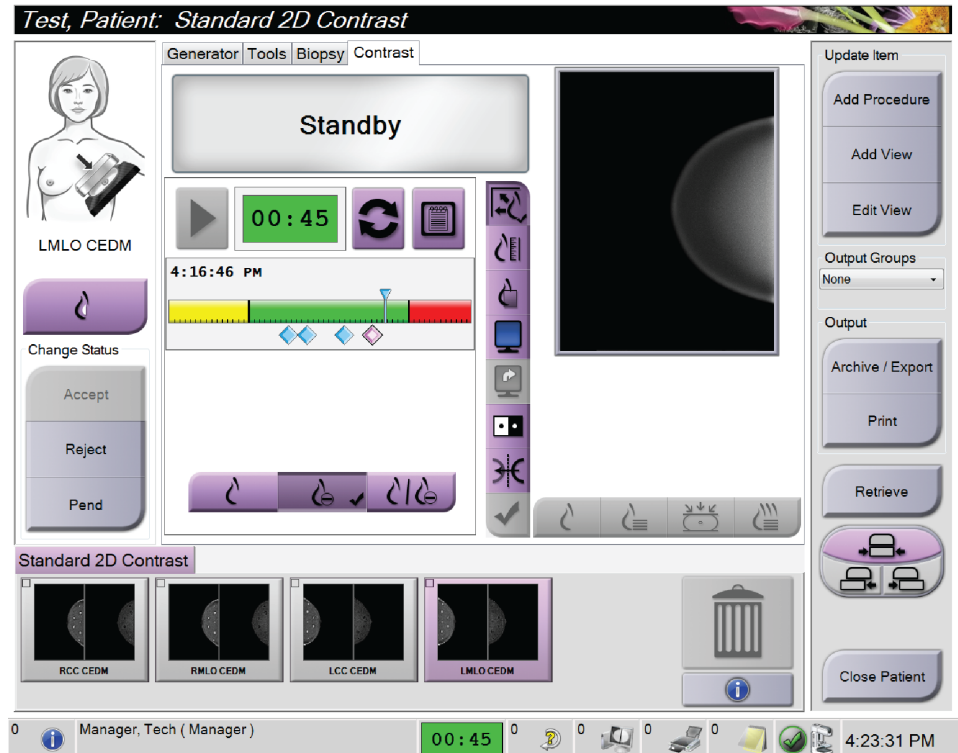


Figure 59: I-View 2D Contrast Screen, Optimal Imaging Period

5. Select the low and high exposure buttons to acquire both low and high energy images.
  - **Low**: Conventional low-energy image
  - **Sub**: Contrasted, subtracted image
  - **Low Sub**: Shows both the low and sub screen images side-by-side in a split screen.




**Caution:**

Performing an I-View 2D Contrast procedure increases the recovery time the machine needs before more images are acquired. When the System Status icon appears red



, a recommended wait time is shown. This wait time lets the x-ray tube temperature decrease to avoid damage that can void the x-ray tube warranty. Always

make sure that the System Status icon is green  before starting an I-View 2D Contrast procedure. If the System Status icon turns red during a procedure, complete the procedure quickly using the minimum number of exposures.

### 6.7.1 How to Configure the Contrast Settings

1. From the **Contrast** tab, select the **Configure Contrast** button to edit the contrast settings. The Contrast Information dialog box opens.

Field	Value	Unit
Contrast Entry Route	Intra-arterial route	
Contrast Agent	Diatrizoate	
Contrast Agent Concentration	240	mg/ml
Total Bolus Volume	0.0	ml
Patient Weight	0.0	lb
Patient Weight	0.0	kg
Contrast Concentration Per Body Weight	0.0	ml/kg
Amount of Contrast Agent	0.0	ml

Figure 60: I-View 2D Contrast Settings

2. Use the drop-down lists to select the appropriate settings.
3. Enter data for the **Contrast Concentration Per Body Weight** field or the **Amount of Contrast Agent** field. The other field automatically populates with the correct information.
4. Select **Save & Close**.



## 6.8 Specimen Imaging

The system can also be used for imaging biopsy specimens.

To acquire specimen images:

1. Select a patient from the worklist, or manually add a new patient.
2. Add or select the required specimen imaging procedure.

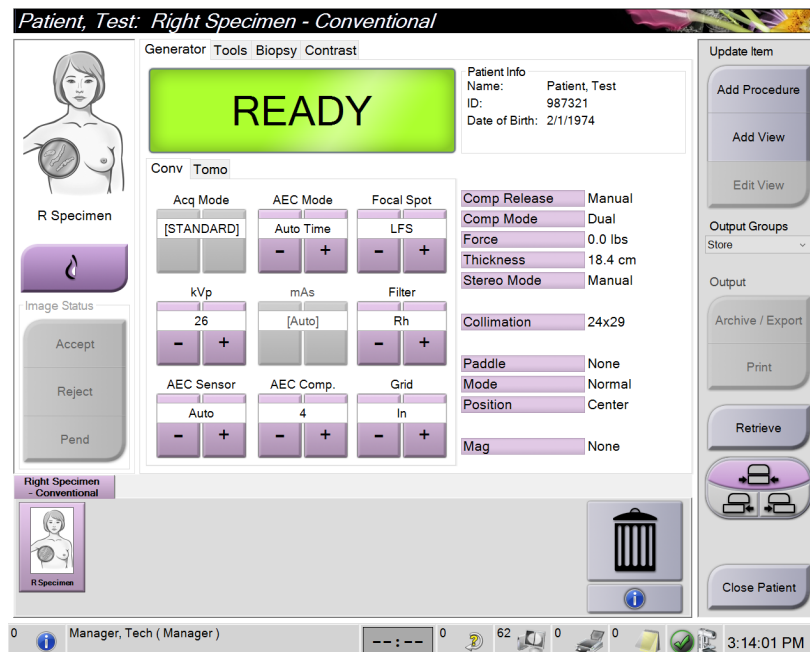


Figure 61: Procedure Screen for Specimens

3. Make sure that the C-arm is set to 0 degrees.
4. Prepare the specimen and place it on the image detector.

5. Acquire the images. For more information on acquiring images, refer to [How to Acquire an Image](#) on page 77.

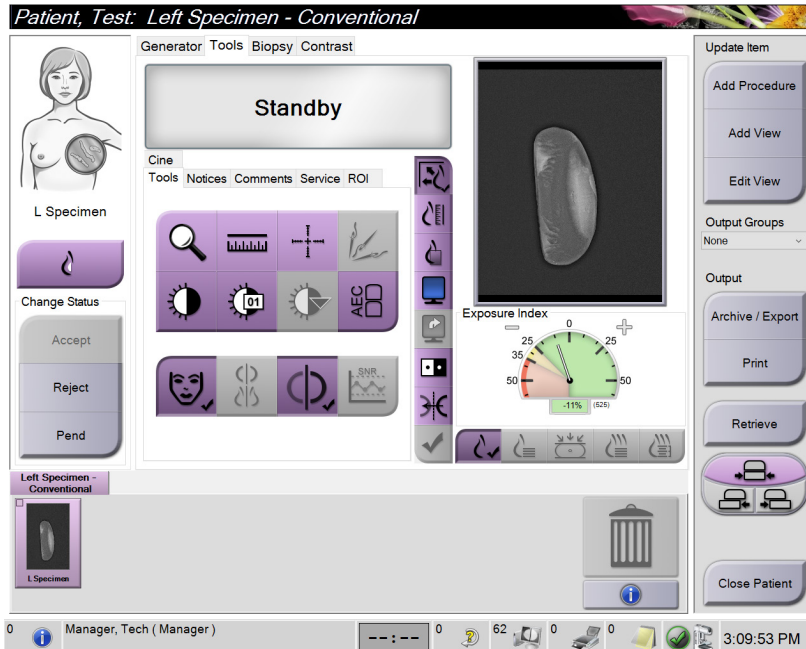


Figure 62: Specimen Imaging Screen

6. Review the images as necessary.

## Chapter 7 Accessories

The system can perform screening or diagnostic applications with specified accessories. This chapter describes how to use all possible system accessories.



### Note

Hologic configures some systems to meet specific requirements. Your system configuration may not have all the options and accessories included in this manual.

## 7.1 How to Install Accessories on the C-Arm

The Retractable Face Shield, Magnification Stand, and Localization Crosshairs are installed in slots on the C-arm. The slots have labels with icons to indicate the accessory that attaches in the slot. Each accessory has two lines. Align the accessory with the related line on the C-arm. When the hook on the accessory is at the correct depth, the second, thinner line aligns with the line on the C-arm. The next sections contain installation instructions for each accessory.

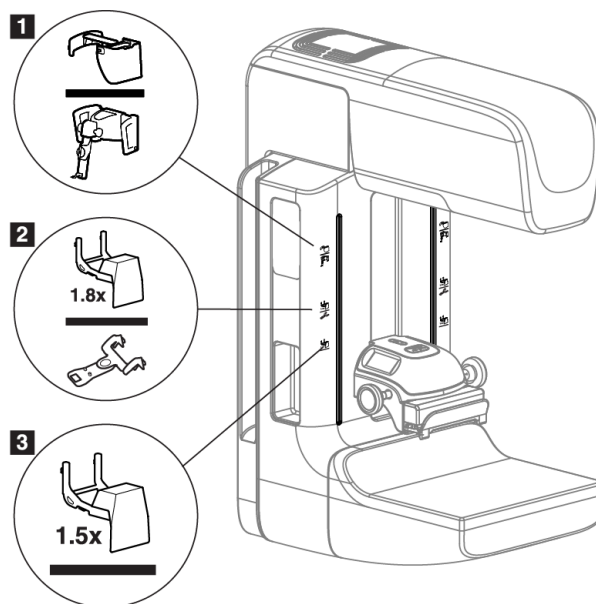


Figure 63: C-arm Accessories

### Figure Legend

1. Slot for Retractable Face Shield (Tomosynthesis option) or the Affirm® breast biopsy guidance system (biopsy option)
2. Slot for 1.8x Mag Stand and Localization Crosshairs
3. Slot for 1.5x Mag Stand

### 7.2 Patient Face Shields

The Face Shield keeps the head and face of the patient away from the x-ray field during the examination. Inspect the shield each day before use.



**Warning:**

**The Face Shield must be attached for all exposures except magnification case studies.**



**Warning:**

**The Face Shield does not protect the patient from radiation.**

#### 7.2.1 How to Install and Remove the Retractable Face Shield

To install the Retractable Face Shield:

1. Completely extend the Face Shield to the outer position.
2. Align the hooks of the Face Shield with the mounting slots on the C-arm, indicated by a face shield icon.
3. Put the hooks on both sides of the Face Shield into the mounting slots on the C-arm. The Unlock Lever (see item 1 in the following figure) is in the Up position.
4. Push the Face Shield to the down and locked position. The Unlock Lever is in the Down position when the Face Shield locks.

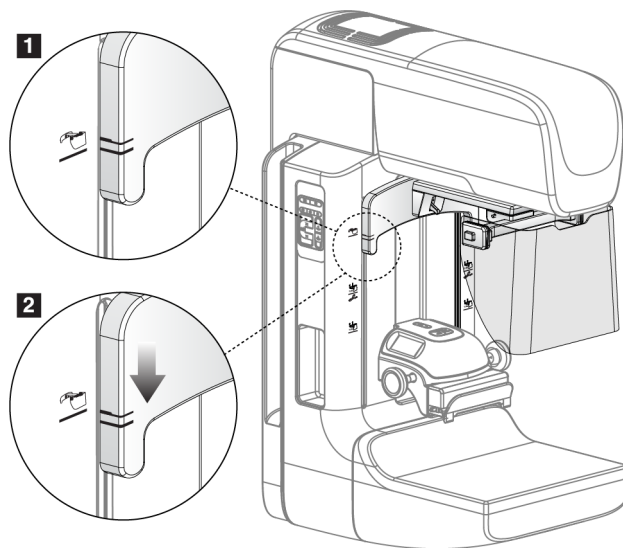


Figure 64: Align the Retractable Face Shield on the C-arm

To remove the Retractable Face Shield:

1. Press and hold the Unlock Lever (see item 1 in the previous figure) in the Up position.
2. Lift the Face Shield from the slots and remove from the C-arm.

## 7.2.2 How to Use the Retractable Face Shield



### Note

Before you make an exposure, make sure the Face Shield is completely extended or completely retracted.

To extend the Face Shield, pull the Face Shield away from the C-arm until the device latches in the outer position.

To retract the Face Shield:

1. Press a Latch Release (see item 2 in the figure [Face Shield Operation](#) on page 93—one on each side).
2. Push the Face Shield toward the C-arm until the device stops.

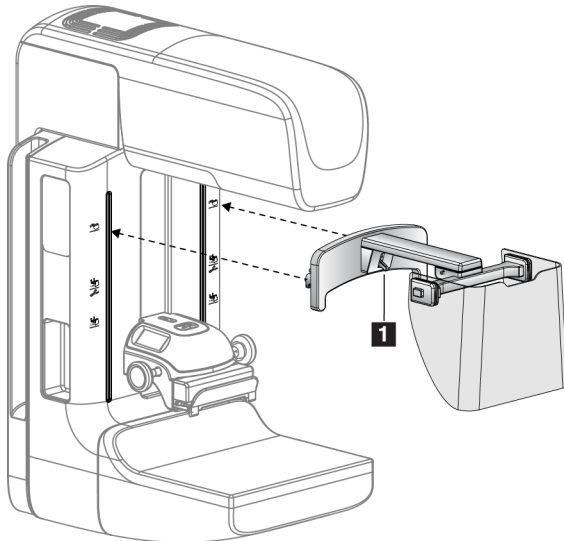


Figure 65: Face Shield Installation

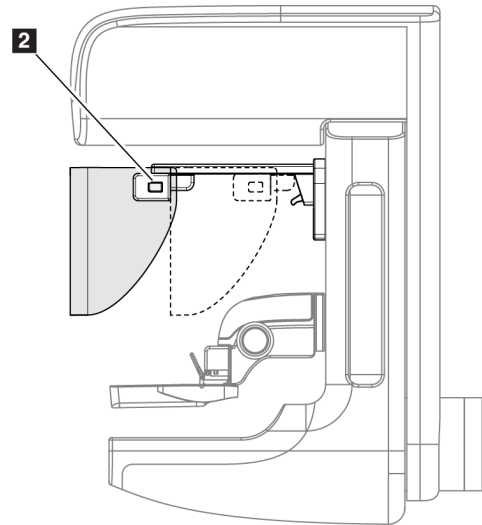


Figure 66: Face Shield Operation

### 7.2.3 How to Install and Remove the Conventional Face Shield

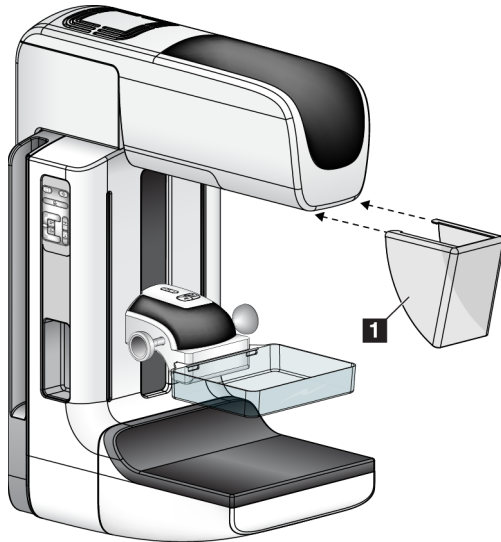


Figure 67: How to Install the Conventional Face Shield

To install the Conventional Face Shield:

1. Carefully put the tab ends of the Face Shield (item 1 in the previous figure) into the slots at the front of the tubehead mount.
2. Slide the Face Shield on the tubehead mount until the Face Shield locks.

To remove the Conventional Face Shield:

1. Pull the sides of the Face Shield in a horizontal direction (away from the tubehead).
2. Remove the Face Shield.

## 7.3 Compression Paddles



### Note

Some paddles are optional and may not be included with your system.

---

The system can identify each paddle and automatically adjust the collimator.

Available accessories depend on your system configuration.

Table 16: Available Accessories

Accessory		2D/BT	2D Screening
Routine Screening Paddles	18 x 24 cm	*	*
	24 x 29 cm	*	*
	Small Breast	*	*
	18 x 24 cm SmartCurve™	*	*
	24 x 29 cm SmartCurve	*	*
Contact and Spot Compression Paddles	10 cm Contact	*	
	15 cm Contact	*	
	7.5 cm Spot Contact	*	See Note
	Frameless Spot Contact	*	
Magnification Paddles	7.5 cm Spot Mag	*	
	10 cm Mag	*	
	15 cm Mag	*	
Localization Paddles	10 cm Rectangular Open	*	
	15 cm Rectangular Open	*	
	10 cm Perforated	*	
	15 cm Perforated	*	
	10 cm Mag Perforated Loc	*	
	10 cm Mag Localization	*	
Ultrasound Paddle	15 cm Large Ultrasound	*	
Patient Face Shield		*	*
Magnification Stand		*	
Localization Crosshair Device		*	
Magnification Crosshair Device		*	



**Note**

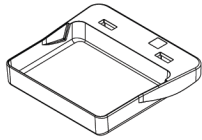
On the 2D screening system, only use the 7.5 cm Spot Contact Paddle for compression thickness calibration.



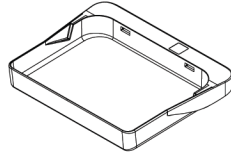
**Note**

The 24 x 29 cm frameless screening paddle, the 24 x 29 cm SmartCurve system paddle, the magnification paddles, and the localization paddles are NOT compatible with the paddle shift function.

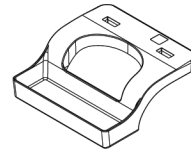
### 7.3.1 Routine Screening Paddles



18 x 24 cm Frameless  
Screening Paddle



24 x 29 cm Frameless  
Screening Paddle



Small Breast  
Frameless Paddle

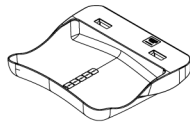
### SmartCurve System Paddles



#### Warning:

The SmartCurve™ system paddles do not meet the IEC 60601-2-45 standards for minimum range of movement that require the paddle to compress to 10 mm. To ensure adequate compression of very small or very thin breasts, use the standard flat screening paddle.

---



18 x 24 cm SmartCurve System  
Frameless Screening Paddle



24 x 29 cm SmartCurve System  
Frameless Screening Paddle



#### Note

The SmartCurve system paddles may not be suitable for patients with very small breasts. If the breast cannot be properly immobilized or compressed due to the curvature of the paddles, use the standard flat screening paddles.

---



#### Note

The SmartCurve system paddles are not recommended for cleavage views, rolled views, or mosaic views of very large breasts. Use the standard flat screening paddles for these views.

---



#### Note

The SmartCurve system paddles accommodate most breast sizes. Due to the curvature of the paddles, some patients who would use the smaller standard flat paddle may be more easily positioned using the larger SmartCurve paddle.

---



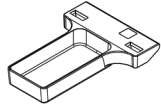
#### Note

SmartCurve system paddles are not compatible with FAST Compression mode.

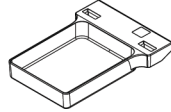
---



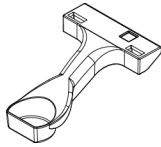
### 7.3.2 Contact and Spot Compression Paddles



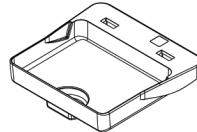
10 cm Contact  
Frameless Paddle



15 cm Contact  
Frameless Paddle

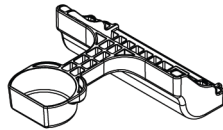


7.5 cm Spot Contact  
Frameless Paddle

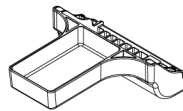


Spot Contact  
Frameless Paddle

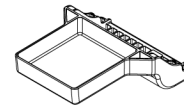
### 7.3.3 Magnification Paddles



7.5 cm Spot Magnification  
Paddle



10 cm Magnification  
Paddle



15 cm Magnification  
Paddle



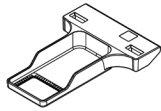
---

**Note**

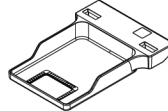
You cannot acquire Tomosynthesis images with the Magnification paddles.

---

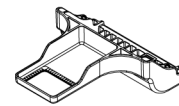
**7.3.4 Localization Paddles**



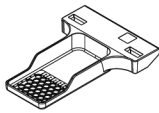
**10 cm Rectangular Opening  
Localization Paddle**



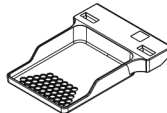
**15 cm Rectangular Opening  
Localization Paddle**



**10 cm Magnification  
Localization Paddle**



**10 cm Perforated  
Localization Paddle**

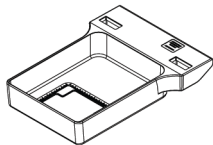


**15 cm Perforated  
Localization Paddle**



**10 cm Magnification  
Localization Perforated Paddle**

**7.3.5 Large Ultrasound Paddle**



**15 cm Large Ultrasound  
Paddle**

### 7.3.6 How to Install and Remove a Compression Paddle

See the figure [How to Install a Compression Paddle](#) on page 99 to install a Compression Paddle:

1. Hold the front of the paddle with one hand in front of the Compression Device.
2. Tilt the paddle (between 30 and 45 degrees), then put the rear of the paddle on the groove in the rear of the Compression Device (item 1).
3. Slide the paddle along the groove until the slots on the top of the paddle are under the locks on the Paddle Clamp (item 2).
4. Compress the Paddle Clamp (item 3) with your free hand.
5. Rotate the paddle up (item 4), then release the Paddle Clamp to lock the paddle.

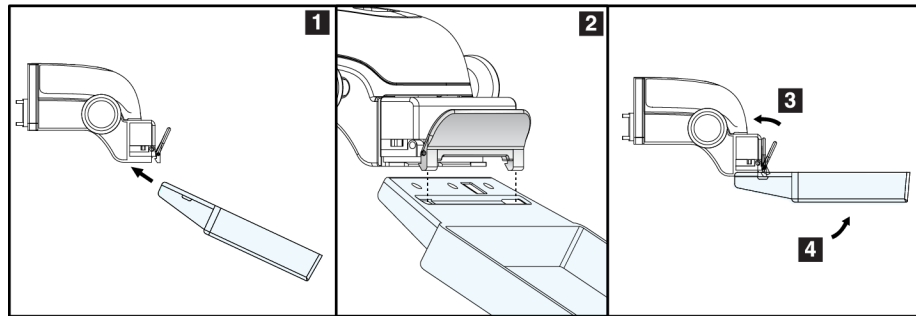


Figure 68: How to Install a Compression Paddle

See the figure [How to Remove the Compression Paddle](#) on page 99 to remove the Compression Paddle:

1. Hold the paddle with one hand while you use the free hand to compress the Paddle Clamp to release the lock (item 1).
2. Lower the paddle (item 2) and remove the paddle from the Compression Device (item 3), then release the Paddle Clamp.

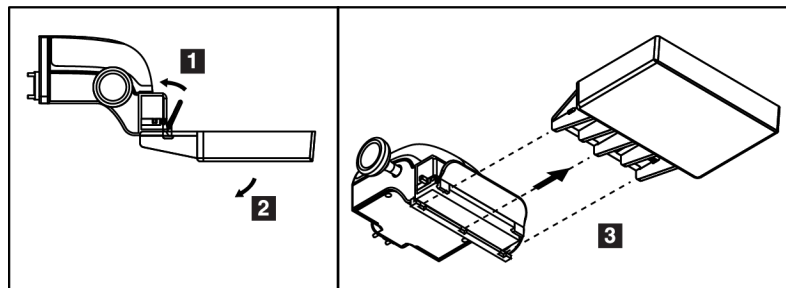


Figure 69: How to Remove a Compression Paddle

### 7.3.7 Paddle Maintenance and Cleaning

Clean the paddles after each use. Refer to [Maintenance and Cleaning](#) on page 113 for cleaning instructions.

### 7.3.8 Paddle Shift

The system allows most paddles to move to the left or right of the center position. The feature helps small-breast examinations with lateral views. When a lateral view is selected, the system automatically moves the collimator for the selected paddle position.



---

**Note**

The 24 x 29 cm frameless screening paddle, the 24 x 29 cm SmartCurve system paddle, and the magnification paddles are NOT compatible with the paddle shift function.

---

### 7.3.9 FAST Compression Mode

#### About FAST Compression Mode

The Fully Automatic Self-adjusting Tilt (FAST) Compression Mode is for use when the composition of the breast tissue does not allow uniform compression across the complete breast with a flat compression paddle. For these patients, not enough compression can cause an image to appear to be out of focus at the anterior region from both involuntary motion and not enough compression.

The FAST Compression mode used with this type of breast provides these features:

- Reduced motion artifacts, because the compression is more effective
- More uniform compression, from the chest wall to the nipple
- Maximum patient comfort, because over compression at the chest wall is prevented

When the FAST Compression mode is selected, the paddle automatically tilts when compression is applied. The paddle starts at the flat position until some compression force is applied. The paddle then tilts until its maximum angle is reached.

The FAST Compression mode does not require excessive compression, but you must use enough compression to prevent the movement of the breast. You should use a consistent amount of compression, especially for related left and right views.

The FAST Compression mode may not be best for breasts that are equal or symmetrical in thickness from the chest wall to the anterior area of the breast.

**Note**

Only the 18 x 24 cm Frameless Screening Paddle and the 24 x 29 cm Frameless Screening Paddle are compatible with FAST Compression Mode.

---

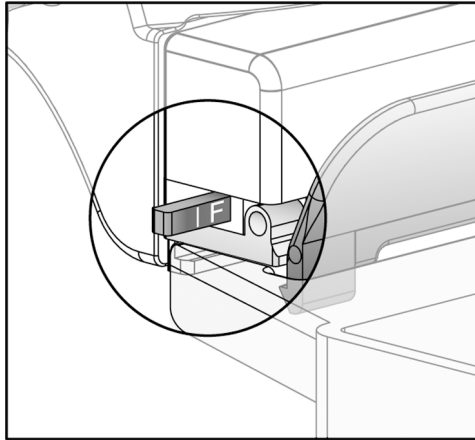
**Note**

The system beeps when FAST Compression Mode is engaged but is not compatible with the current paddle.

---

### **How to Use the FAST Compression Mode Slide**

To engage FAST Compression Mode, push the slide (from either side) until the "F" is visible and the slide clicks into position.



*Figure 70: The FAST Compression Mode Slide*

## 7.4 Magnification Stand

The Magnification Stand has a breast platform and an abdominal shield. When the Magnification Stand is installed, the grid automatically retracts and the x-ray exposure techniques are set to the Magnification default values. Only use the Magnification paddles when the Magnification Stand is installed (refer to [Magnification Paddles](#) on page 97).

### 7.4.1 How to Install and Remove the Magnification Stand

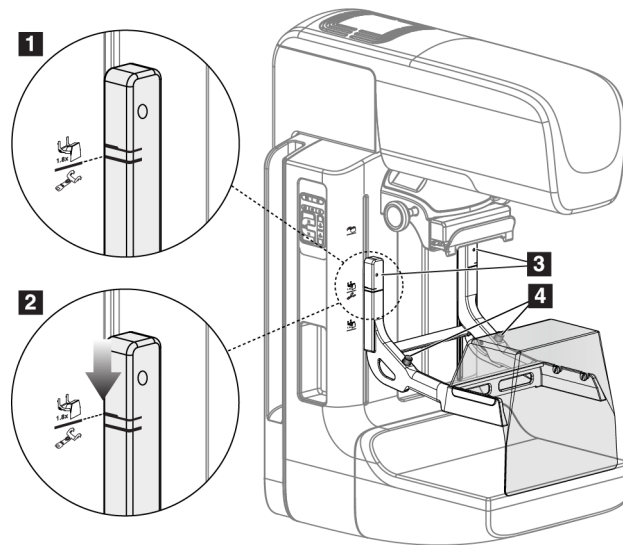


Figure 71: Installation of the Magnification Stand

**To Install the Magnification Stand**

1. Remove the Face Shield (refer to [Patient Face Shields](#) on page 92).
2. Remove the compression paddle (refer to [How to Remove the Compression Paddle](#) on page 99).
3. Move the Compression Device completely to the top.
4. Hold the stand on each side just below the black buttons, item 4. Do not press the black buttons.



**Note**

The black buttons are used only when removing the Magnification Stand.

---



**Note**

There are two sets of mounting slots for the Magnification Stand—One set is for 1.8x, and the other set is for 1.5x. See numbers 2 and 3 in the figure [C-arm Accessories](#) on page 91.

---

5. Align the thick black lines on the Magnification Stand with the thick black lines on the C-arm. When these lines meet, the hooks of the Magnification Stand align to the mounting slots on the C-arm. See item 1 in the previous figure.
6. Put the hooks of the Magnification Stand into the C-arm slots. Slide the Magnification Stand down, until the thin black lines on the Magnification Stand and the black line of the C-arm meet. See item 2 in the previous figure.
7. The locking pins slide into holes and lock the device. You hear an audible click.



**Note**

If the Magnification Stand is not installed correctly, there is an indicator with a red shaft which protrudes. See item 3 in the previous figure. When the stand is installed correctly, the indicator is retracted.

---

**To Remove the Magnification Stand**

1. Remove the Magnification paddle.
2. Hold the handles of the Magnification Stand and press the black buttons.
3. Lift and remove the device from the C-arm.

### 7.5 Crosshair Devices

#### 7.5.1 How to Install and Remove the Localization Crosshair Device

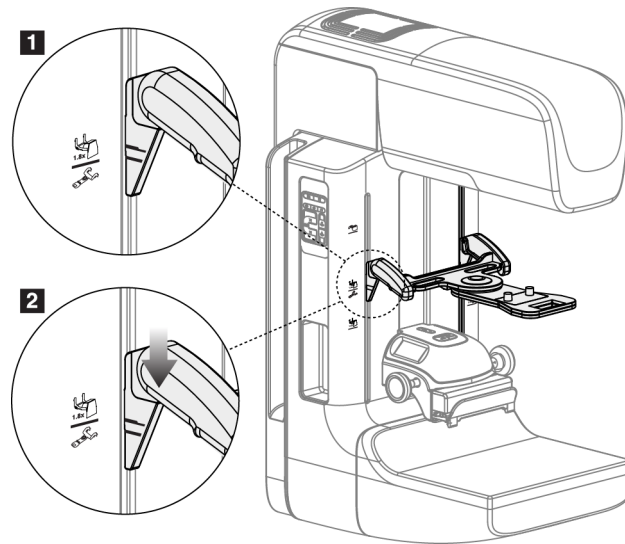


Figure 72: Installation of the Localization Crosshair Device

#### To Install the Localization Crosshair Device

1. Remove the face shield (refer to [Patient Face Shields](#) on page 92).
2. Move the Compression Device below the mounting slots, indicated by a crosshair icon. See item 2 in the figure [C-arm Accessories](#) on page 91.
3. Hold the crosshair device by the handles and align the thick lines on the device with the line on the C-arm. Compress the release levers.
4. Put the hooks into the C-arm slots.
5. Slide the hooks toward the bottom until the thin black lines on the crosshair meet the black line on the C-arm.
6. Release the levers. The locking pins slide into holes and lock the device in position.

#### To Remove the Localization Crosshair Device

1. Compress the release levers.
2. Lift the frame toward the top and remove the hooks from the C-arm slots.



### 7.5.2 How to Use the Localization Crosshair Device

1. The crosshair device rotates to the left or right of the tubehead. Rotate the device away from the x-ray beam during the exposure acquired with the localization paddle.
2. When you rotate the device back to the front for use, make sure the rotation continues until the device clicks into position.
3. Turn on the light field lamp.
4. Rotate the two crosshair knobs until the shadow on the breast matches the crosshairs on the image that identifies the suspect lesion.

### 7.5.3 How to Install and Remove the Magnification Crosshair Device

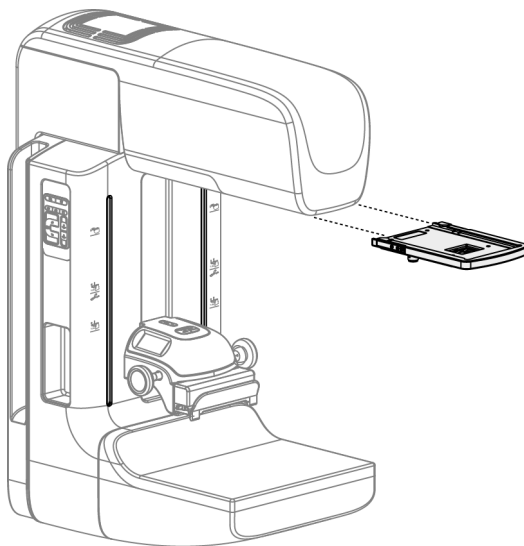


Figure 73: How to Install and Remove the Magnification Crosshair Device

#### To Install the Magnification Crosshair Device

1. Remove the face shield (refer to [How to Install and Remove the Conventional Face Shield](#) on page 94).
2. Align the Magnification Crosshair Device with the tubehead.
3. Slide the crosshair device on the rails on each side of the tubehead that are used by the Conventional Face Shield. Make sure the device locks into position.
4. Install the remaining magnification devices.

#### To Remove the Magnification Crosshair Device

1. Hold the sides of the device.
2. Pull the device toward you and remove from the tubehead.

### 7.5.4 How to Align the Crosshair Device



---

**Note**

If the crosshair light rectangle appears skewed to the opening in the paddle, perform this alignment procedure.

---

1. Install the rectangular localization paddle.
2. Loosen the adjustment lock screw on the bottom of the Crosshair Device.
3. Put a piece of white paper on the image receptor to make the shadows of the crosshairs easier to see.
4. Move the localization paddle approximately 6 cm above the image receptor.
5. Turn on the light field.
6. Rotate the Crosshair Device until the rectangle of light aligns with the opening in the localization paddle.
7. Tighten the adjustment screw.

## Chapter 8 Clinical Procedures



---

**Warning:**  
**C-arm movement is motorized.**

---



---

**Warning:**  
**Keep the hands of the patient away from all buttons and switches at all times.**

---



---

**Warning:**  
**Place each footswitch in a position where, when used, they remain in reach of the Emergency Off Switches.**

---



---

**Warning:**  
**Position the footswitches to prevent accidental operation by a patient or wheelchair.**

---

### 8.1 Standard Workflow

#### 8.1.1 Preparation

1. Select a patient from the worklist, or manually add a new patient.
2. Identify the required procedures.
3. Select the output device set if a different or additional device is needed.
4. Install the paddle.
5. Select the first view.

#### 8.1.2 At the Gantry

1. Set C-arm height and rotation angle.
2. Make sure the light field illuminates the correct area.
3. Position the patient and compress the breast.

### 8.1.3 At the Acquisition Workstation

1. Set the exposure technique.
2. Acquire the image.
3. Release the patient.
4. Preview the image. Look at the Exposure Index to make sure that the exposure is within acceptable range.
5. You can use the Window/Level tool or other image review options during image preview.
6. Accept, Reject, or Pend the image.
7. Perform the Acquisition cycle as required for the requested procedures.
8. If necessary, add an additional view or procedure.
9. Make sure that the patient is safely away from the system after you complete the examination.
10. Close the procedure.

## 8.2 Screening Procedure Example

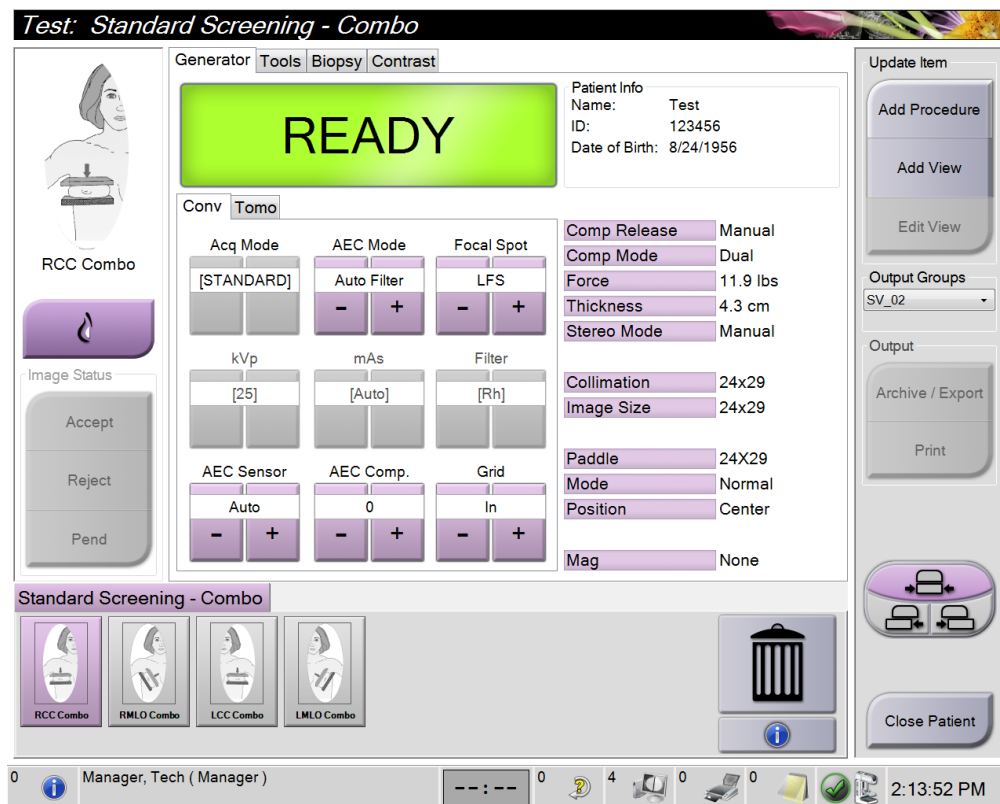


Figure 74: Example of a Screening Procedure Screen

### 8.2.1 Position the Patient

1. Lift or lower the breast platform for the patient.
2. Move the tubehead to the projection angle.
3. Move the patient to the C-arm.
4. Position the patient as required.
5. Put the arm or hand of the patient on the Patient Handle or against the side of the body.
6. Tell the patient to keep away from system controls.
7. Compress the breast.
  - When possible, use the footswitch controls to provide hands-free compression control and C-arm height adjustment.
  - Use the light field lamp as necessary to see the x-ray field.
  - Apply compression slowly. As necessary, stop and make the adjustments to patient position.
  - Use the handwheels for final compression.

### 8.2.2 Set the Exposure Techniques

Select the exposure techniques for the procedure. Refer to [How to Set the Exposure Parameters](#) on page 76 for information.

### 8.2.3 Acquire the Exposure

1. Confirm that all exposure factors are set correctly.
2. If the system does not display Ready in 30 seconds, verify that the accessories are correctly installed and the paddle is locked into position. When the generator status displays **Ready**, the system is ready for exposure.



**Warning:**

**This system can be dangerous to the patient and the user. Always follow the safety precautions for x-ray exposures.**

---

3. Press and hold the **x-ray** button and/or the **x-ray footswitch** for the full exposure.

During the exposure:

- A System Message with the radiation symbol and a yellow background is displayed (see the following figure)
- An audible tone continues to sound during the exposure

The behavior of the audible tone during a combo exposure has changed to avoid early releases of the x-ray button and/or the x-ray footswitch by users. The audible tone is now a continuous sequence of tones. The tone sounds during the entire combo acquisition from the initiation of the exposure to the end of the conventional view. There is no interruption of the audible tone between breast tomosynthesis and conventional digital mammography exposures. Do not release the exposure switch during the audible tone.

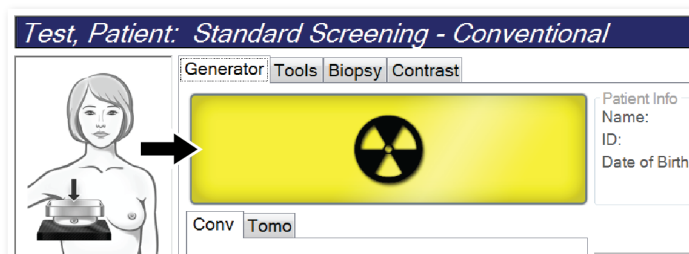


Figure 75: Exposure In Progress

4. When the tone stops and the System Message shows **Standby** (see the following figure), you can release the **x-ray** button and/or the **x-ray footswitch**.

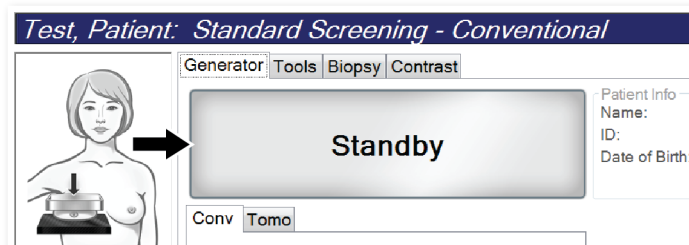


Figure 76: Exposure Complete

5. Release the compression device. If the automatic release feature is set, the compression device automatically lifts after the exposure.

### 8.3 Procedure for Needle Localization with Tomosynthesis

1. Install a Localization Paddle, and install the Crosshair Device at the Tubehead. Be sure that the crosshair guides are out of the x-ray field.
2. Open a new procedure with a Tomo or TomoHD view for your approach.
3. Position the patient and apply compression.
4. Acquire a Tomo Scout. Make sure that the ROI is visible inside the Localization Paddle opening. If not, reposition the patient and repeat.
5. Note the Compression Thickness, and note the thickness of the excess tissue through the opening of the Localization Paddle.
6. Scroll through the reconstruction slices to identify where the lesion is best seen. Note the slice number (each slice is 1 mm in thickness).
7. Place the Acquisition Workstation crosshair on the lesion.
8. To find the coordinates for the Gantry Crosshair Device, scroll through the reconstructions until you can identify the alpha numeric coordinates.
9. Calculate the needle depth:

Value	Example
Breast Compression Thickness	50 mm
(+) Thickness of the tissue through the opening of the paddle	+ 7 mm
(-) Slice number where the lesion is found	- 30 mm
(+) Optional distance past the ROI for the wire	+ 5-15 mm
(=) Needle depth of the localization wire	32– 42 mm

10. Turn on the collimator light and align the Crosshair Device at the Tubehead to match the Acquisition Workstation crosshair.
11. Position and insert the needle.
12. Move the Crosshair Device guides out of the x-ray field.
13. Acquire another Tomo image to be sure that the needle is in the correct location. To calculate if a correction is necessary, compare the slice number of the point of the needle and the slice number of the lesion.
14. Insert the guide wire through the needle, and then remove the needle, if desired, leaving the wire in position.
15. If desired, complete the following steps:
  - a. Acquire a Conventional or Tomo view to be sure of correct wire placement.
  - b. Take the orthogonal view to document wire or needle placement (either in Tomo or conventional).
16. Only add one view icon at a time for orthogonal views to remove the possibility of paddle shift due to possible minimal compression.

### Example: Calculating Needle Depth with Tomosynthesis

In this example, use the values from the table on the previous page and refer to the following figure.

Calculate the needle depth from the tissue skin line (item 1) rather than from the localization paddle (item 9). Insert the needle a minimum of 27 mm (breast compression + bulging tissue).

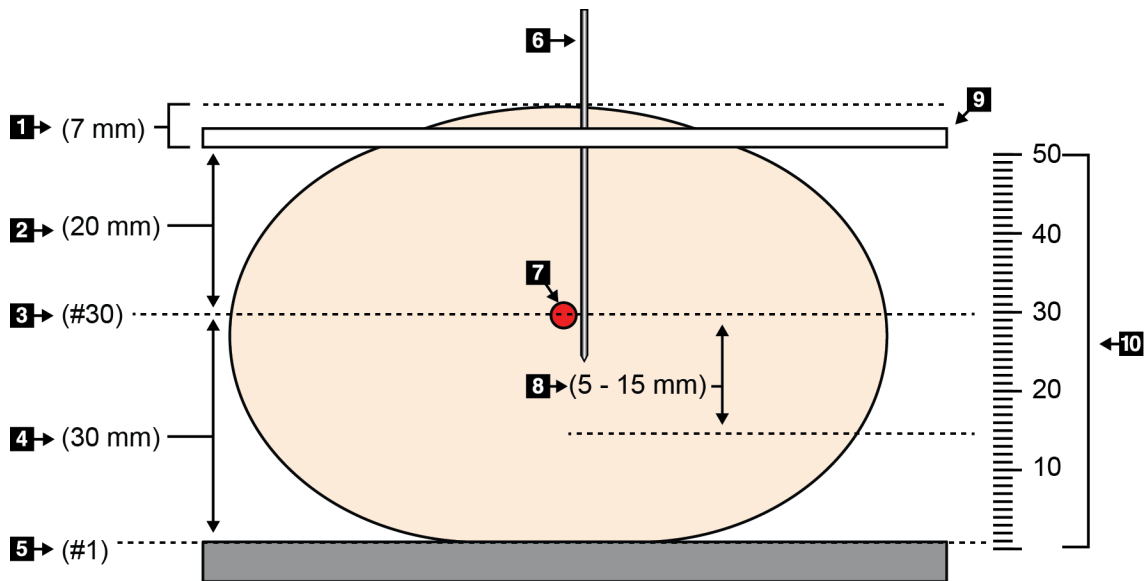


Figure 77: Calculating needle depth

Item	Description	Example
1	Thickness of the tissue through the opening of the localization paddle	7 mm
2	Thickness measured from the localization paddle to the lesion	
3	Lesion slice number (the slice number where lesion is best seen (clearest))	30 mm
4	Thickness measured from the detector to the lesion	
5	Slice number 1	
6	Needle	
7	Lesion	
8	Advancing the needle 5 - 15 mm more than the lesion (optional)	5 - 15 mm
9	Localization paddle	
10	Thickness of the breast compression from the detector (0 mm) to the localization paddle (50 mm in this example)	50 mm



## Chapter 9 Maintenance and Cleaning

### 9.1 Cleaning

#### 9.1.1 General Information About Cleaning

Before each examination, clean and use a disinfectant on any part of the system which touches a patient. Give the attention to the paddles and the image receptor.



---

**Caution:**

**Do not use any hot source (like a heating pad) on the image receptor.**

---

Be careful with the compression paddles. Inspect the paddles. Replace the paddle when you see damage.

#### 9.1.2 For General Cleaning

Use a lint-free cloth or pad and apply a diluted dishwashing liquid.



---

**Caution:**

**Use the least possible amount of cleaning fluids. The fluids must not flow or run.**

---

If more than soap and water is required, Hologic recommends any one of the following:

- 10% chlorine bleach solution and water with one part commercially available chlorine bleach solution (normally 5.25% chlorine and 94.75% water) and nine parts water. Mix this solution daily for best results.
- Commercially available isopropyl alcohol solution (70% isopropyl alcohol by volume, not diluted)
- 3% maximum concentration of hydrogen peroxide solution

After you apply any of the above solutions, use a pad and apply a diluted dishwashing liquid to clean any parts that touch the patient.



---

**Warning:**

**If a paddle touches possible infectious materials, contact your Infection Control Representative to remove contamination from the paddle.**

---



---

**Caution:**

**To prevent damage to the electronic components, do not use disinfectant sprays on the system.**

---

#### 9.1.3 To Prevent Possible Injury or Equipment Damage

Do not use a corrosive solvent, abrasive detergent, or polish. Select a cleaning/disinfecting agent that does not damage the plastics, aluminum, or carbon fiber.

Do not use strong detergents, abrasive cleaners, high alcohol concentration, or methanol at any concentration.

Do not expose equipment parts to steam or high temperature sterilization.

Do not let liquids enter the internal parts of the equipment. Do not apply cleaning sprays or liquids to the equipment. Always use a clean cloth and apply the spray or liquid to the cloth. If liquid enters the system, disconnect the electrical supply and examine the system before returning it to use.



---

**Caution:**

**Wrong cleaning methods can damage the equipment, decrease imaging performance, or increase the risk of electric shock.**

---

Always follow instructions from the manufacturer of the product you use for cleaning. The instructions include the directions and precautions for the application and contact time, storage, wash requirements, protective clothing, shelf life, and disposal. Follow the instructions and use the product in the most safe and effective method.

#### 9.1.4 Acquisition Workstation

##### How to Clean the Image Display Screen

Avoid touching the display screen of the Image Display monitor.

Use care when cleaning the outer surface of the LCD screen. Always use a clean, soft, lint-free cloth to clean the display area. Microfiber cloths are recommended.

- Never use a spray or flow a liquid on the display.
- Never apply any pressure to the display area.
- Never use a detergent with fluorides, ammonia, alcohol, or abrasives.
- Never use any bleach.
- Never use any steel wool.
- Never use a sponge with abrasives.

There are many commercially available products to clean LCD displays. Any of the products free of the ingredients described above and used according to the directions of the manufacturer can be used.

### How to Clean the Touchscreen Display

Use a window or glass cleaning product to clean the Touchscreen display. Apply the cleaning product to a cloth, then clean the Touchscreen display. Do not apply the cleaning product to the display without the cloth.

### How to Clean the Keyboard

Wipe the surfaces with a CRT wipe. If necessary, clean the keyboard with a vacuum. If liquids enter the keyboard, contact Technical Support for a replacement.

### How to Clean the Fingerprint Scanner



---

**Caution:****To protect the Fingerprint Scanner:**

- Do not apply any liquid product directly on the Fingerprint Scanner window.
  - Do not use products that contain alcohol.
  - Never put the Fingerprint Scanner under liquid.
  - Never apply any pressure to the Fingerprint Scanner window with abrasive material.
  - Do not push the Fingerprint Scanner window.
- 

To clean the Fingerprint Scanner window, do one of the following:

- Apply the adhesive side of cellophane tape, then remove the tape.
- Apply a product with ammonia base to a cloth, and clean the Fingerprint Scanner window.

## 9.2 Maintenance

### 9.2.1 Preventive Maintenance Schedules

Table 17: User Preventive Maintenance

Maintenance Task Description	Recommended Frequency					
	Each Use	Weekly	Biweekly	Monthly	Bimonthly	Semiannually
Clean & disinfect paddle	✓					
Clean & disinfect breast platform	✓					
Visually inspect all paddles for damage	✓					
Detector Flat Field Calibration *		✓				
Artifact Evaluation *		✓				
Phantom Image *		✓				
Signal to Noise / Contrast to Noise Measurements *		✓				
Geometry Calibration (Tomosynthesis Option) *						✓
Compression Thickness Indicator *			✓			
Visual Checklist *				✓		
Compression *						✓

\* Refer to Quality Control Manual

Table 18: Service Engineer Preventive Maintenance

Maintenance Task Description	Recommended Frequency	
	Semiannually	Annually
Clean and Inspect the Gantry and Acquisition Workstation	✓	
Inspect the radiation shield for chips, cracks, breaks, and for tight attachments.	✓	
Check all primary power connections	✓	
Check interlocks, safety and limit switches	✓	
Inspect/Lubricate C-arm	✓	
C-arm / Verify all C-arm buttons	✓	
Verify C-arm and Rotational Calibration	✓	
Replace Breast Platform Filter	✓	
Verify Compression Force Calibration	✓	
Verify Compression Thickness Calibration	✓	
Inspect LED Collimator Lamp for dust and dirt	✓	
Clean & lubricate collimator, and worm screws	✓	
Perform Rotational Brake verification	✓	
Verify X-ray Field / Light Field Calibration	✓	
Verify kV Calibration and Tube Current Calibration	✓	
Check HVL Evaluation	✓	
Verify Target Dose Verification	✓	
Verify AEC Exposure Compensation 2D	✓	
Perform System Resolution Test *	✓	
Perform Phantom Image Quality Evaluation *	✓	
Perform Image Artifact Evaluation *	✓	
Backup Acquisition Workstation files	✓	
Evaluate UPS Performance Status/ Batteries Status	✓	
Backup all Calibration Data	✓	
* Refer to Quality Control Manual		

### 9.2.2 About Reclamation

Reclamation is an automatic function that makes disk space available for storing newly acquired images. Configurable parameters let a given number of images collect before reclamation starts and older images are removed from the system.

## Chapter 10 System Administration Interface

### 10.1 Admin Screen

This section describes the functions available in the *Admin* screen. To access all the functions in this screen, log in to the system as a user with administrator, manager, or service permissions.

Refer to the table on the following page for descriptions of the *Admin* screen functions.



**Note**

Depending on the license settings for your system, you may see different buttons.

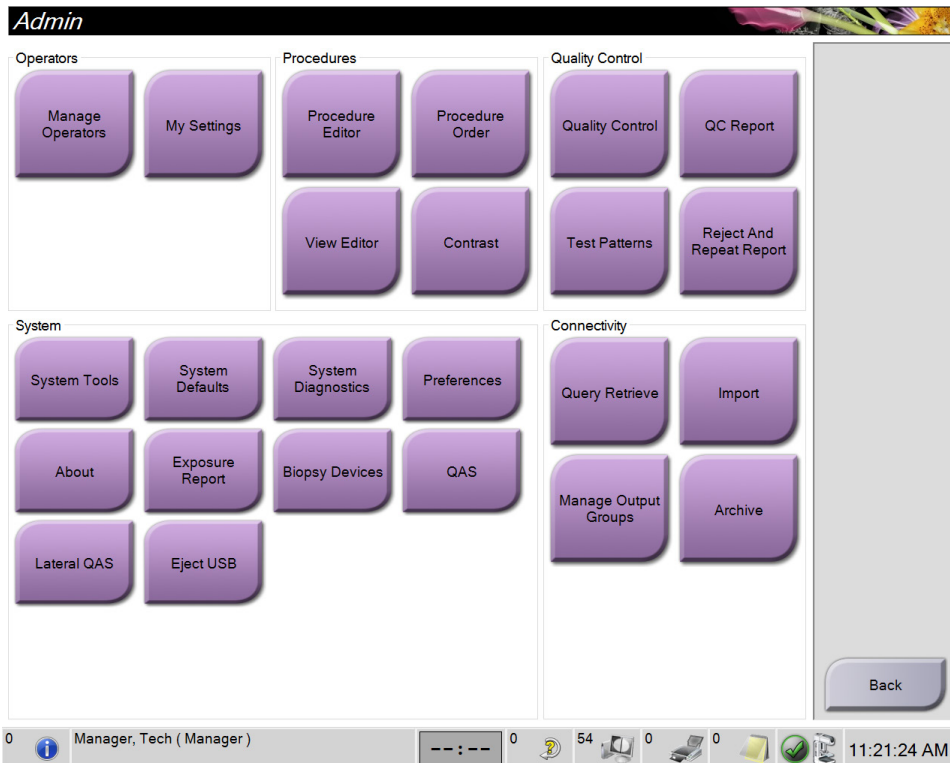


Figure 78: Admin Screen

# Selenia Dimensions System User Guide

## Chapter 10: System Administration Interface

Table 19: Admin Screen Functions

Group	Button	Function
Operators	<b>Manage Operators</b>	Add, delete, or change Operator information.
	<b>My Settings</b>	Change the information for the current Operator.
Procedures	<b>Procedure Editor</b>	Add or Edit the procedures, or change the view order for each user.
	<b>Procedure Order</b>	View or change the order of the procedures within a procedure group.
	<b>View Editor</b>	Set the default view order for a procedure and edit individual views.
	<b>Contrast</b>	Access the contrast enhanced digital mammography functionality and configure the default settings.
Quality Control	<b>Quality Control</b>	Select a Quality Control task to perform or mark completed.
	<b>QC Report</b>	Create a QC Report.
	<b>Test Patterns</b>	Select and send the test patterns to output devices.
	<b>Reject and Repeat Report</b>	Create a Reject and Repeat Report.
System	<b>System Tools</b>	The Interface for Service for the configuration of or the identification of problems in the Acquisition Workstation.
	<b>System Defaults</b>	Set the Gantry default values.
	<b>System Diagnostics</b>	Shows the status of all subsystems.
	<b>Preferences</b>	Set the system preferences.
	<b>About</b>	Describes the system. Refer to <a href="#">About Screen</a> on page 121.
	<b>Exposure Report</b>	Create a radiation Exposure Report.
	<b>Biopsy Devices</b>	View and configure available biopsy devices.
	<b>QAS</b>	Access the <i>QAS Needle Test</i> screen.
	<b>Lateral QAS</b>	Access the <i>Lateral QAS Needle Test</i> screen.
<b>Eject USB</b>	Eject a media storage device connected to the USB port.	
Connectivity	<b>Query Retrieve</b>	Query and retrieve patient information from the configured devices.
	<b>Import</b>	Import the data from a DICOM source.
	<b>Manage Output Groups</b>	Add, delete, or edit output groups.
	<b>Archive</b>	Send local studies to networked storage or export to removable media devices.

You must have permission to access all features. The permission level controls the functions you can access and change.





### 10.2.1 Licensing Tab

The **Licensing** tab of the *About* screen shows all the licenses installed on your system.



#### Note

Hologic configures some systems to meet specific requirements. Your system configuration may not have all the options and accessories included in this manual.

---

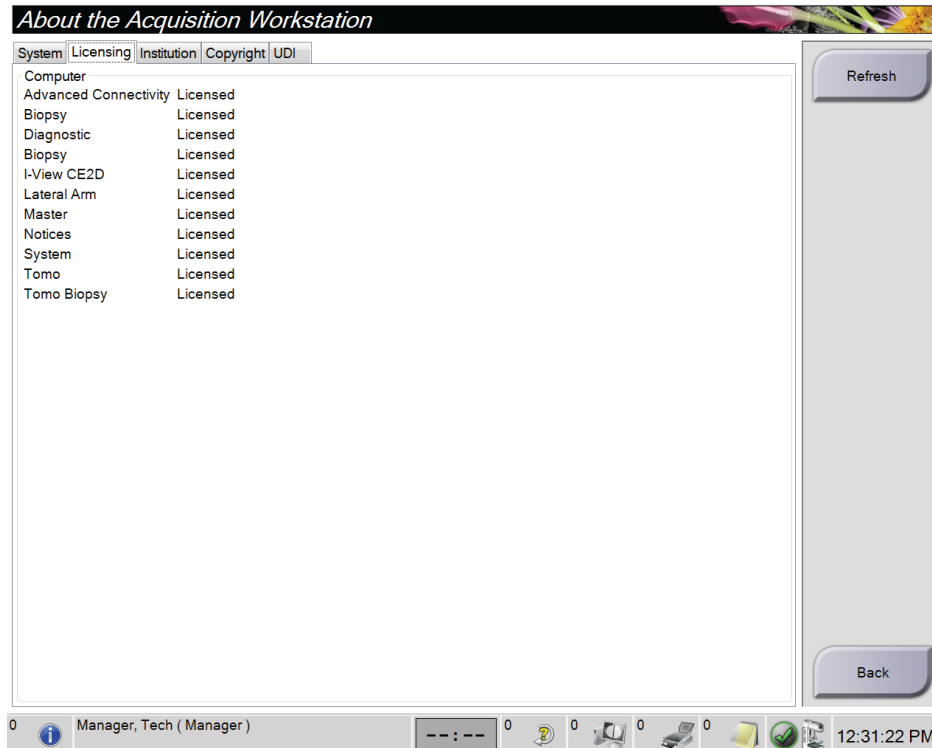


Figure 80: Licensing Tab of the About Screen

### 10.3 Change the User Language Preference

Users can set the language on the user interface to automatically change to their individual preference when logging in.

1. In the Operators group of the *Admin* screen, select **My Settings**.



#### Note

You can also access **My Settings** through the taskbar. Select the User Name area then select **My Settings** in the pop-up menu.

---

2. The **Users** tab of the *Edit Operator* screen opens. From the Locale field, select a language from the drop-down list.
3. Select **Save**, then select **OK** to the *Update Successful* message. The user interface changes to the selected language.

## 10.4 Set Auto-Hanging and Auto-Pairing

To set the system for Auto-Hanging and Auto-Pairing of images:

1. In the Operators group of the *Admin* screen, select **My Settings**.



### Note

You can also access **My Settings** through the Taskbar. Select the User Name area then select **My Settings** in the pop-up menu.

2. The *Edit Operator* screen opens. Select the **Workflow** tab.
  - Select the Auto-Hanging check box to show a prior study in 4-up mode automatically.
  - Select the Auto-Pairing check box to show a prior view in multi-up mode next to a newly captured image.

*Edit Operator: Manager, Tech*

User Workflow

Auto Hanging

Enable Auto Hanging	<input checked="" type="checkbox"/>
CC image placement	Top
Left laterality image placement	Right
Auto Hanging repeated views	Hang older

Auto Pairing

Enable Auto Pairing	<input checked="" type="checkbox"/>
Auto Pairing protocol	On thumbnail selection
Auto Pairing repeated views	Pair older
Match Chest Walls	<input checked="" type="checkbox"/>

Figure 81: Enable Auto-Hanging and Auto-Pairing

3. Select **Save**, then select **OK** to the *Update Successful* message.

### 10.5 Set Multi Line Procedure Tabs

You can set the operator preferences to display more of the procedure name in the top of the procedure tabs. To change the procedure tabs from a single line of text to multiple lines of text:

1. In the Operators group of the *Admin* screen, select **My Settings**.



#### Note

You can also access **My Settings** through the Taskbar. Select the User Name area then select **My Settings** in the pop-up menu.

---

2. The *Edit Operator* screen opens. Select the **Workflow** tab.
3. Select the **Use Multi Line Procedure Tabs** check box.

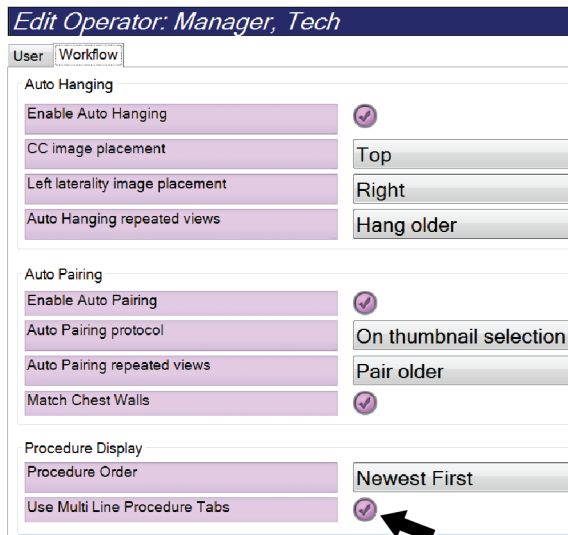


Figure 82: Enable Multi Line Procedure Tabs

4. Select **Save**, then select **OK** in the *Update Successful* message.

## 10.6 Enable and Set the Height Memory

Users can enable and set the acquisition workstation height to automatically change to their individual preference when logging in. To enable and set the height adjust memory:

1. In the Operators group of the *Admin* screen, select **My Settings**.

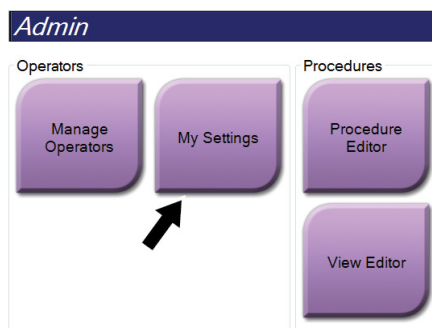


Figure 83: My Settings Button in the Admin Screen



### Note

You can also access **My Settings** through the Taskbar. Select the User Name area then select **My Settings** in the pop-up menu.

2. In the *Edit Operator* screen, select the **Console** tab.
3. To enable the height adjust memory, select the radio button to the right of the "Auto-Height adjustment on login" field. A check mark appears. (To disable the height adjust memory, clear the radio button.)

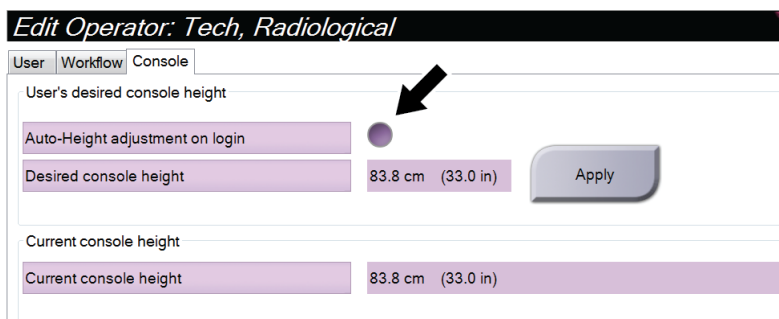


Figure 84: Console Tab of the Edit Operator Screen

4. Use the ▲ UP and ▼ DOWN buttons on the height adjust control panel to set the desired height (see the following figure).

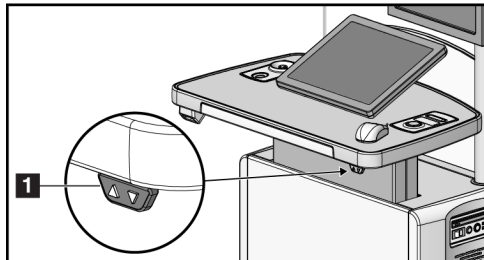


Figure 85: Height Adjust Control Panel

5. The Desired console height field displays the height as it is now positioned. The Current console height field displays the most recently saved height. (See the following figure.) To save your desired height setting, select **Apply**.

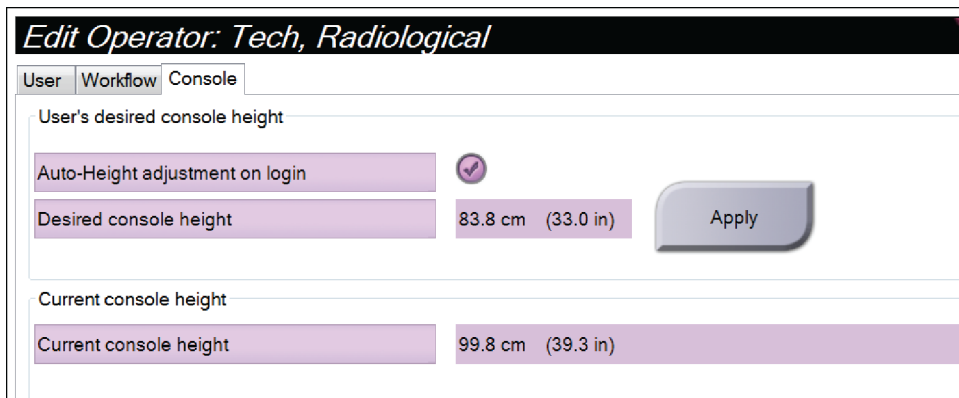


Figure 86: Desired Console Height and Current Console Height Fields

6. Select **Save**, then select **OK** to the *Update Successful* message.

## 10.7 Set Auto-Accept and Auto-Pend Images

A manager user can configure the system to automatically accept or automatically pend new images.

1. In the System group of the *Admin* screen, select **Preferences**. The *System Preferences* screen opens.
2. Select the **Image Auto Disposition** tab.
3. Use the drop-down menus to select the auto disposition for each type of image.
  - Select **Manual** to manually accept, reject, or pend each newly acquired image.
  - Select **Accept** to automatically accept newly acquired images.
  - Select **Pend** to automatically pend newly acquired images.

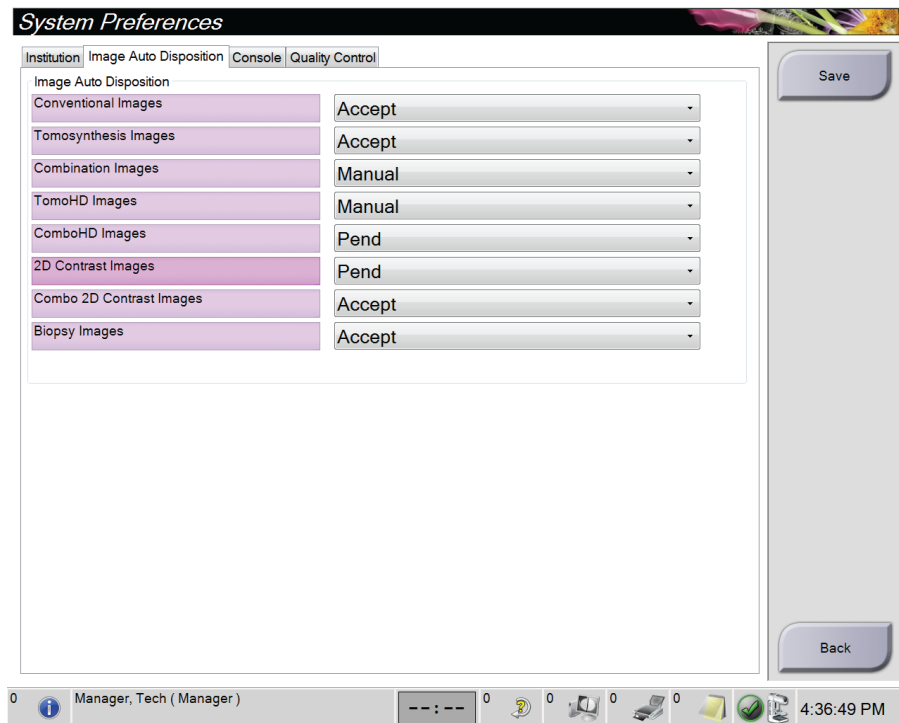


Figure 87: Set Image Auto Disposition

4. Select **Save**, then select **OK** to the *Update Successful* message.

## 10.8 Set the Contrast Defaults

A manager user can configure the default timer periods and the default contrast information.

### Set the Default Timer Periods

1. From the Procedures group in the *Admin* screen, select the **Contrast** button.

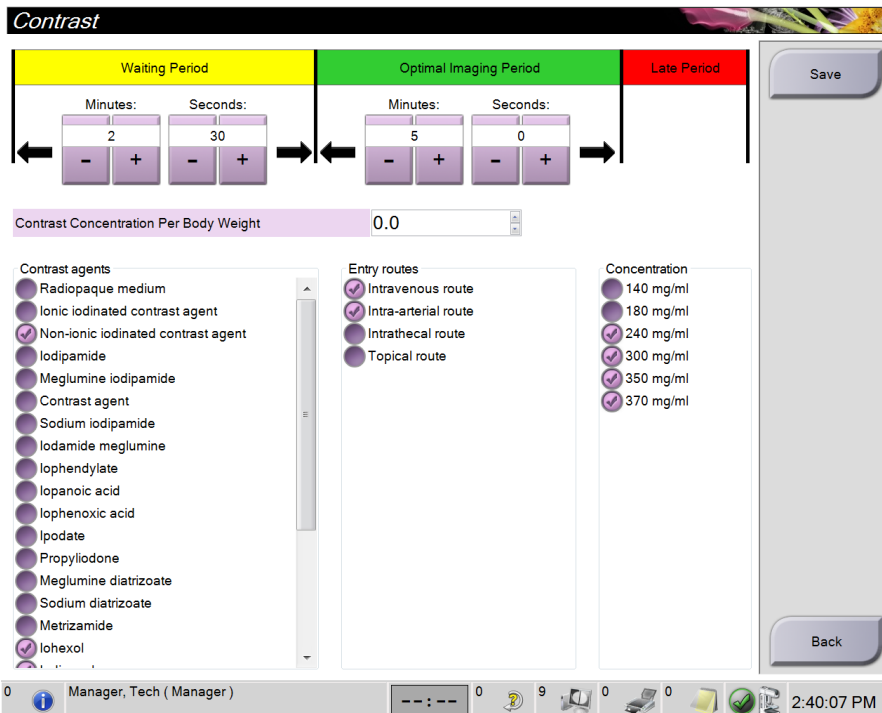


Figure 88: I-View 2D Contrast Default Settings

2. Choose the plus (+) or minus (-) buttons to change the Minutes and Seconds for the **Waiting Period** and **Optimal Imaging Period**.
3. Select **Save**.

Your selections appear as the default timer settings on the **Contrast** tab.

### Set the Default Contrast Information

1. From the Procedures group in the *Admin* screen, select the **Contrast** button.
2. Select one or more **Contrast agents**, **Entry routes**, and **Concentration**. See the previous figure.
3. Select **Save**.

Your selections appear as the default options in the Contrast Information dialog box.



## 10.9 Enable and Set the Default Height

A manager can set the acquisition workstation to automatically return to a default height when a user logs out. To enable and set the default height:

1. In the System group of the *Admin* screen, select **Preferences**.

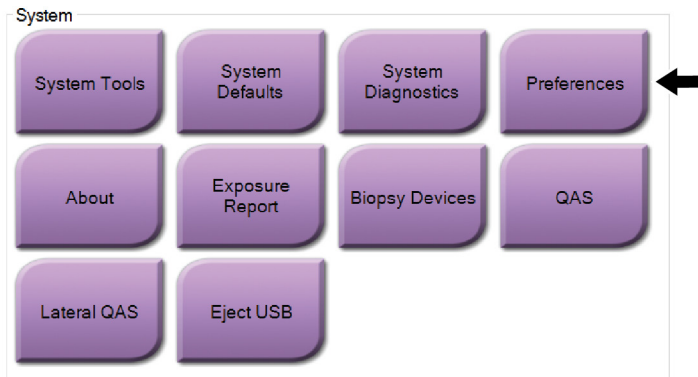


Figure 89: Preferences Button in the Admin Screen

2. In the *System Preferences* screen, select the **Console** tab.
3. To enable the default height, select the radio button to the right of the "Auto-Height adjustment on logout" field. A check mark appears. (To disable the default height option, clear the radio button.)

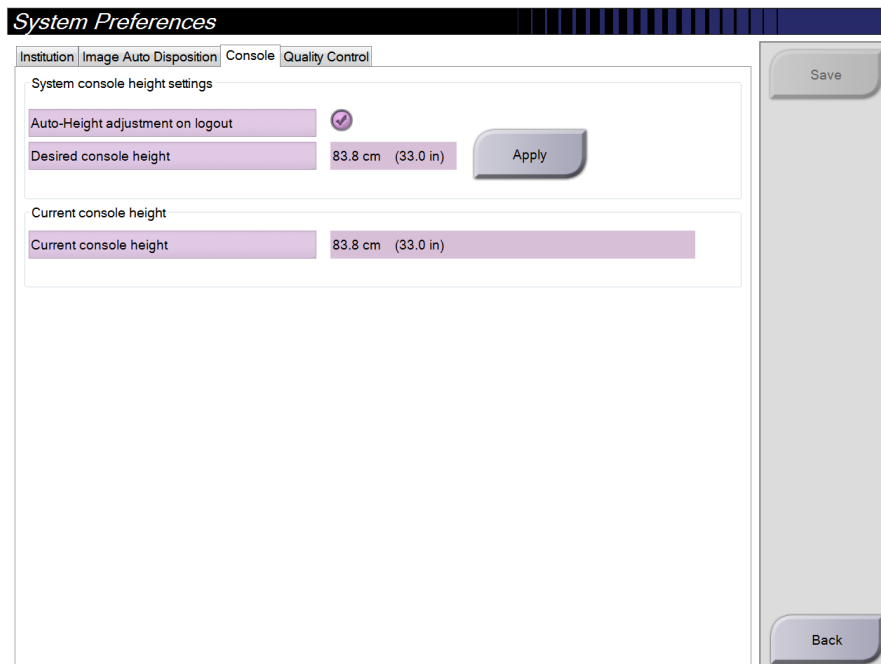


Figure 90: Console Tab of the System Preferences Screen

- Use the ▲ UP and ▼ DOWN buttons on the height adjust control panel to set the desired height (see the following figure).

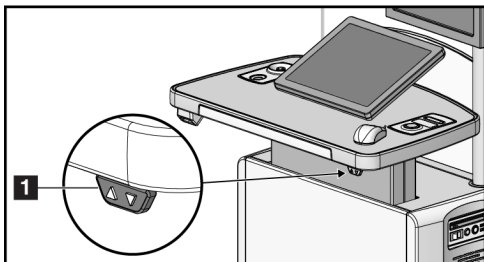


Figure 91: Height Adjust Control Panel

- The Desired console height field displays the height as it is now positioned. The Current console height field displays the most recently saved height. (See the following figure.) To save your desired height setting, select **Apply**.

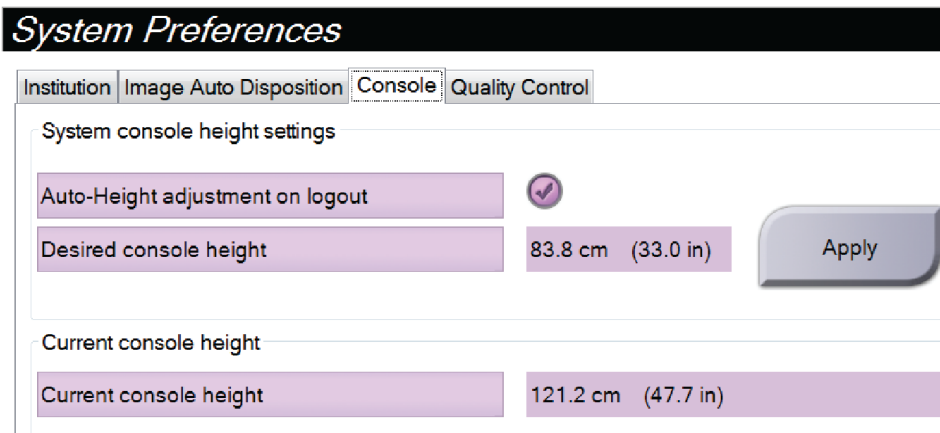


Figure 92: Desired Console Height and Current Console Height Fields

- Select **Save**, then select **OK** to the *Update Successful* message.

## 10.10 System Tools

The Radiologic Technologist Managers and users with Service permissions can access the System Tools utility. The System Tools utility contains the configuration information about the system. To access the utility, select **System Tools** from the System group in the *Admin* screen.

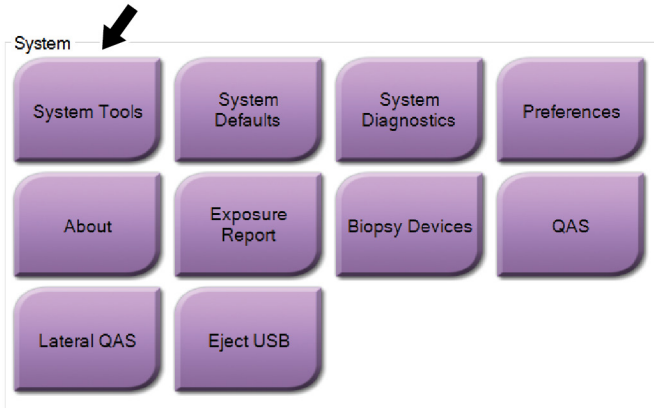


Figure 93: System Tools Button

### 10.10.1 System Tools for the Radiologic Technologist Manager

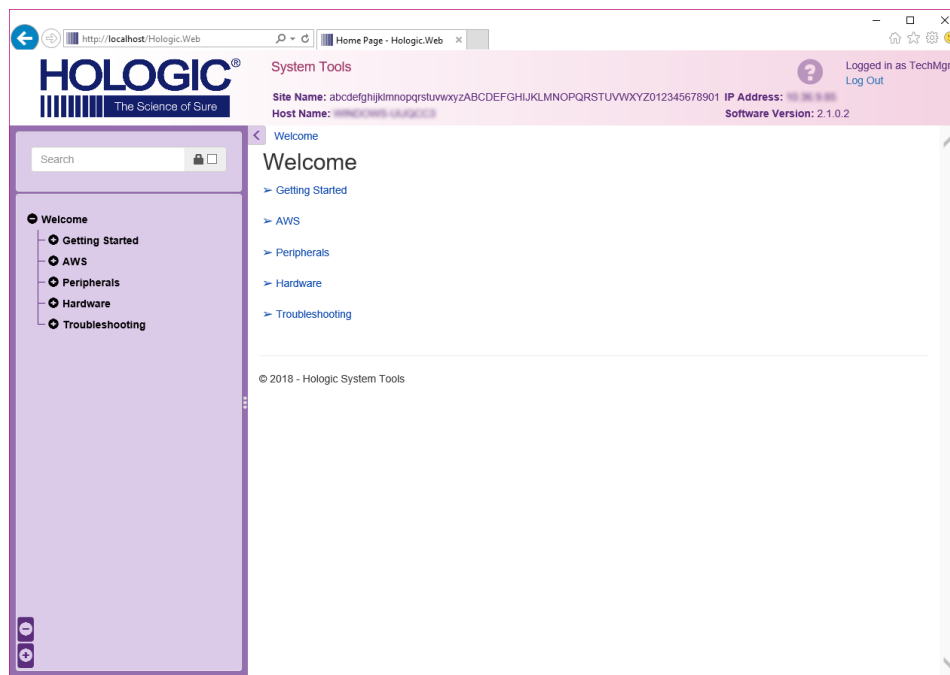


Figure 94: System Tools Screen

Table 20: Radiologic Technologist Manager—System Tools Functions

Section	Screen Functions
Getting Started	<p><b>About:</b> The introduction to the service tool.</p> <p><b>FAQ:</b> List of common questions.</p> <p><b>Glossary:</b> List of terms and descriptions.</p> <p><b>Platform:</b> List of directories, software version numbers, and system software statistics.</p> <p><b>Shortcuts:</b> List of Windows shortcuts.</p>
AWS	<p><b>Connectivity:</b> List of Installed Devices.</p> <p><b>Film &amp; Image Information:</b> Create an Image Report*. Create a QC Report. (*You can also access this report from a remote computer. Refer to <a href="#">Remote Access to Image Reports</a> on page 133.)</p> <p><b>Licensing:</b> List of Installed Licenses.</p> <p><b>User Interface:</b> Change the options in the Software application.</p> <p><b>Internationalization:</b> Select the local language and culture.</p>
Troubleshooting	<p><b>AWS:</b> Allows for download of images.</p> <p><b>Computer:</b> System Management and Network Information.</p> <p><b>Log:</b> Change the event record options.</p> <p><b>Backups:</b> Control the backups for the system.</p>

### 10.10.2 Remote Access to Image Reports

Access image reports via a remote computer networked to the system. This function can be useful for sites that do not permit USB downloads of reports directly from the system.

Follow these steps to access image reports from a remote computer. You must log in to the System Tools as a Manager-level user for this procedure.

1. Get the IP Address for the system you want to access. You can get the IP Address from your IT administrator or from the system. From the system, go to the *About* screen and select the **System** tab. Write down the IP Address.
2. Using an internet browser on your remote computer, navigate to `http:// [IP address]/Hologic.web/MainPage.aspx`. Use the IP Address from step 1.
3. The *System Tools Login* screen opens. Type a Manager-level user name and password, and then select the **Log in** button.

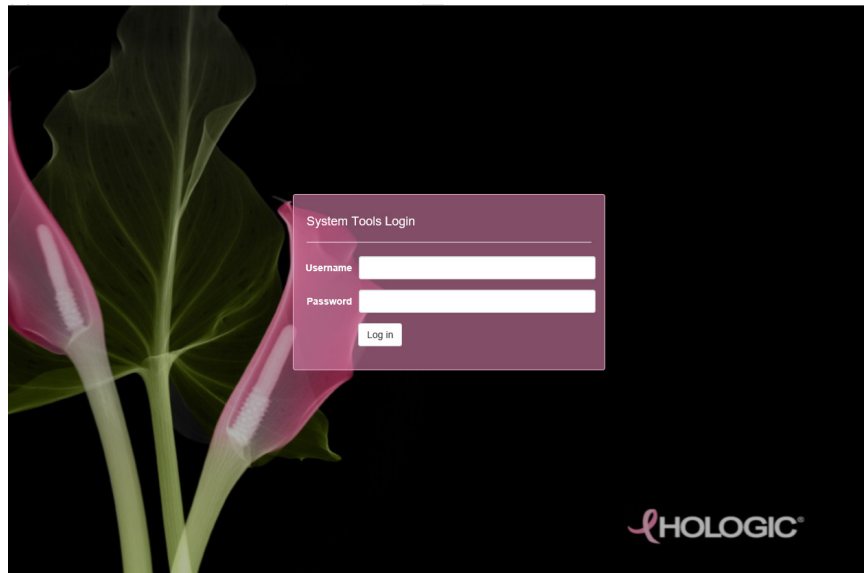


Figure 95: System Tools Login Screen

4. The *System Tools Welcome* screen opens. Go to **AWS > Film & Image Information > Create Image Report**.

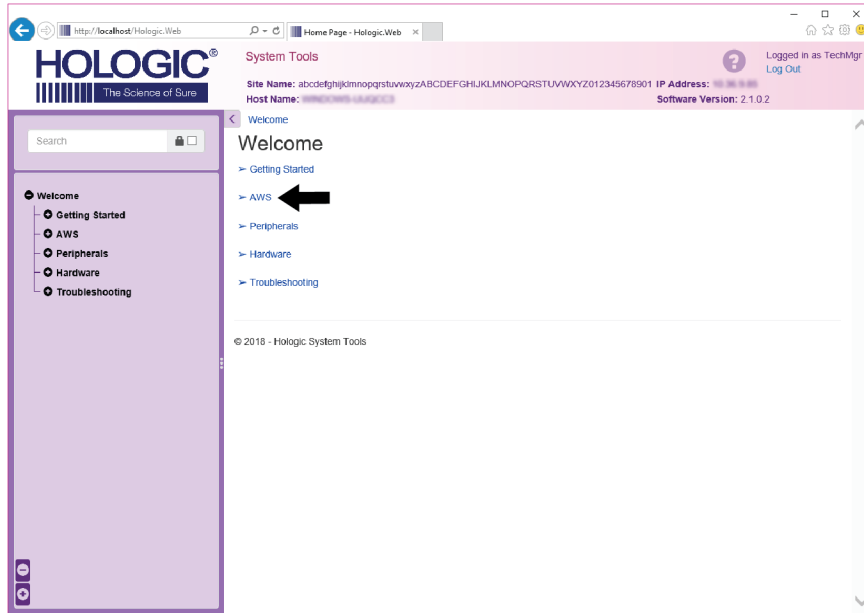


Figure 96: System Tools Welcome Screen

5. Select the parameters for the report and click **Generate**.

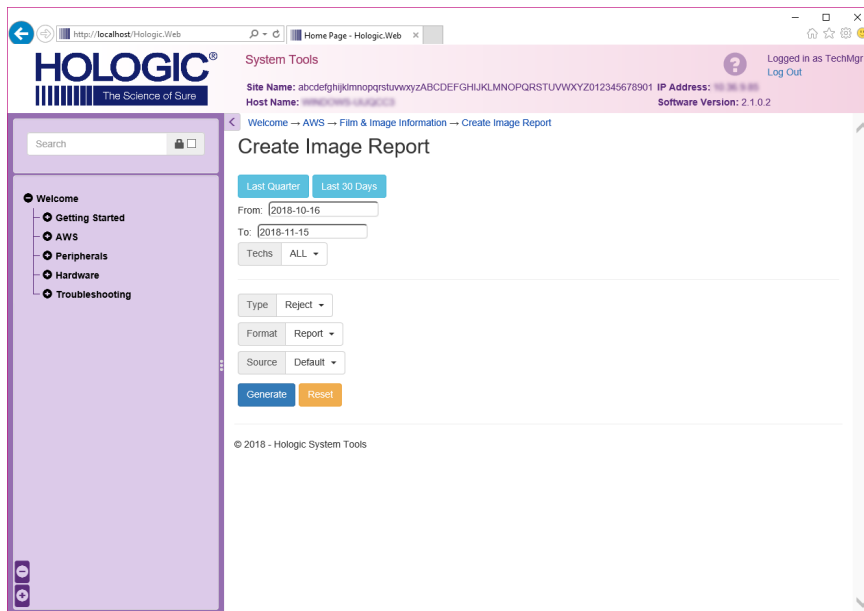


Figure 97: Create Image Report Parameters

- The report shows on the screen. Scroll to the bottom of the report and select either **Download to (html)** or **Download to (csv)** for the file download type. Click **Save** when prompted.

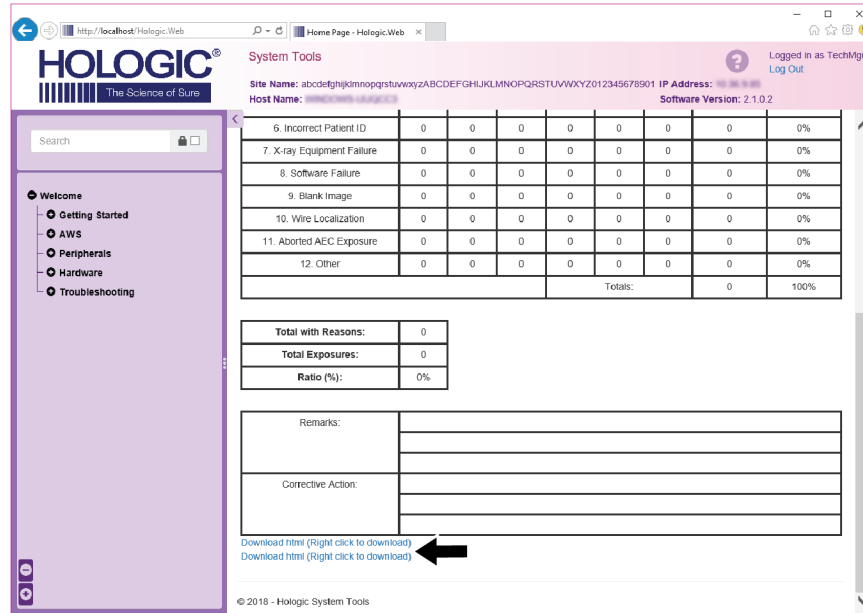


Figure 98: Download the Image Report

- Select a folder on the computer, and then click **Save**.
- Log out** from System Tools when finished.

### 10.11 Archive Tool

The archive feature in the *Admin* screen lets you:

- Send local studies to an archive.
- Export studies to removable media.

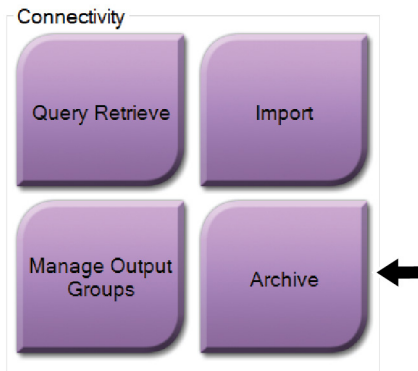


Figure 99: Archive Button

1. From the Connectivity group in the *Admin* screen, select the **Archive** button. The *Multi Patient On Demand Archive* screen opens.
2. To search for a patient, enter at least two characters in the Search parameters area and select the magnifying glass.

A list of patients that match the search criteria is displayed.

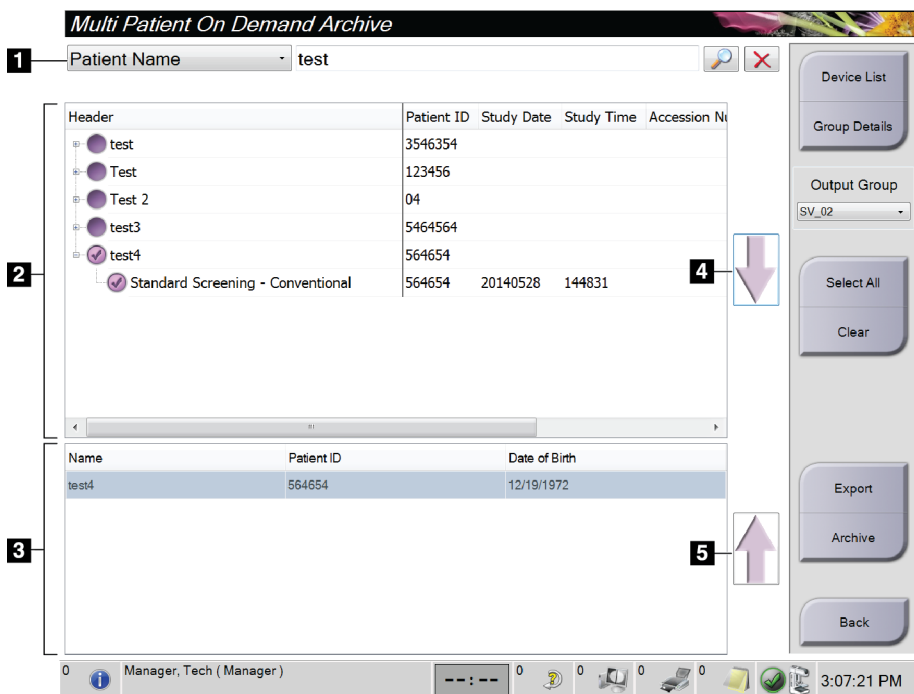


Figure 100: Multi Patient On Demand Archive Screen

#### Figure Legend

1. Search parameters
2. Patient List area
3. Patients to Be Archived or Exported area
4. Add selection in the Patient List area to the Patients to Be Archived or Exported area
5. Remove the selection from the Patients to Be Archived or Exported area



### To Archive:

1. Select the patients and the procedures to archive.
    - Select patients from the patient list, or do a search with the search parameters (item 1) and select patients from the search results.
- 



#### Note

The **Select All** button (on the right side of the screen) selects all the patients in the Patient List area. The **Clear** button (on the right side of the screen) clears selections.

---

- Select the procedures for each patient.
  - Select the **Down Arrow** (item 4) on the screen to move the selected patients to the Patients To Be Archived area (item 3).
  - Select the **Up Arrow** (item 5) on the screen to remove the selected patients from the Patients To Be Archived area (item 3).
2. Select a storage device.
    - Select an option from the Store Device drop-down menu.
- OR-
- Select the **Group List** button, then select an option.
3. Select the **Archive** button. The list in the Patients To Be Archived area copies to the selected archive devices.
- 



#### Note

Use the Manage Queue utility in the taskbar to review the archive status.

---

### To Export:

1. Select the patients and the procedures to export.
  - Select patients from the patient list, or do a search with one of the search parameters (item 1) and select patients from the search results.



---

#### Note

The **Select All** button (on the right side of the screen) selects all the patients in the Patient List area. The **Clear** button (on the right side of the screen) clears selections.

---

- Select the procedures for each patient.
  - Select the **Down Arrow** (item 4) on the screen to move the selected patients to the Patients To Be Archived area (item 3).
  - Select the **Up Arrow** (item 5) on the screen to remove the selected patients from the Patients To Be Archived area (item 3).
2. Select the **Export** button.
  3. In the *Export* dialog box, select the Target from the drop-down list of media devices.

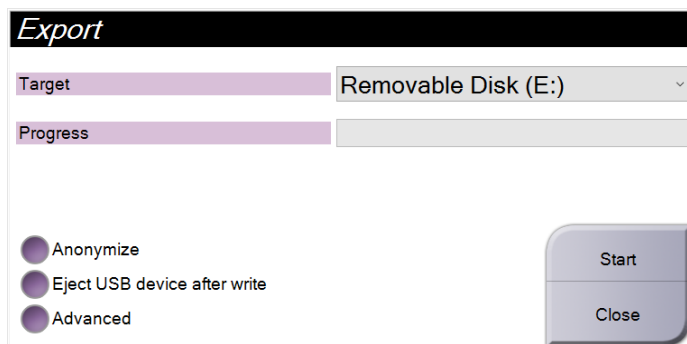


Figure 101: Export Screen

4. Select other options, if necessary:
  - **Anonymize**: to anonymize patient data.
  - **Eject USB device after write**: to automatically eject the removable media storage device when the export is complete.
  - **Advanced**: to select a folder on your local system for storage of your selections, and also to select the Export Types of the images.
5. Select the **Start** button to send the selected images to the selected device.

## Appendix A Specifications

### A.1 Product Measurements

#### A.1.1 Tubestand (Gantry with C-Arm)

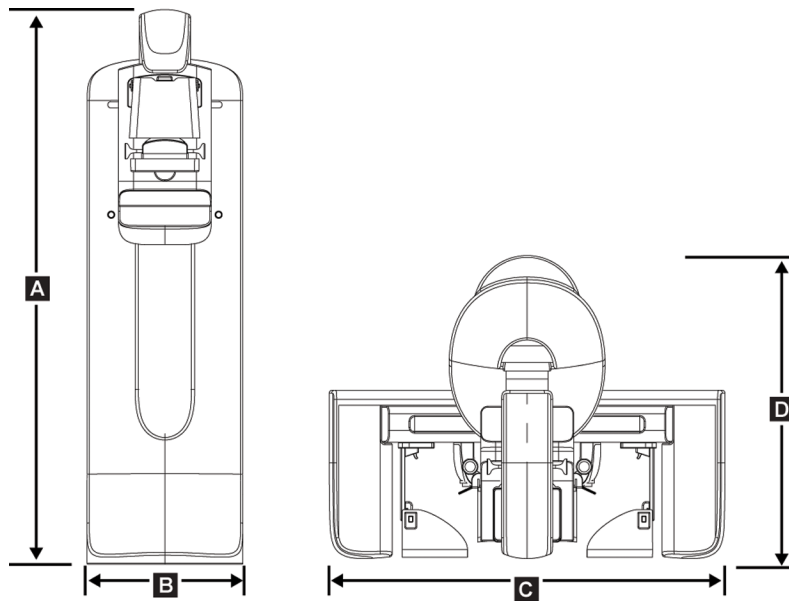


Figure 102: Tubestand (Gantry with C-arm) Measurements

A.	Height	223 cm (87.8 inches)
B.	Width	66 cm (26 inches)
C.	Width	173 cm (68.0 inches)
D.	Depth	138 cm (54.3 inches)
	Weight	Maximum of 400 kg (882 pounds)

### A.1.2 Acquisition Workstations

#### Universal Acquisition Workstation

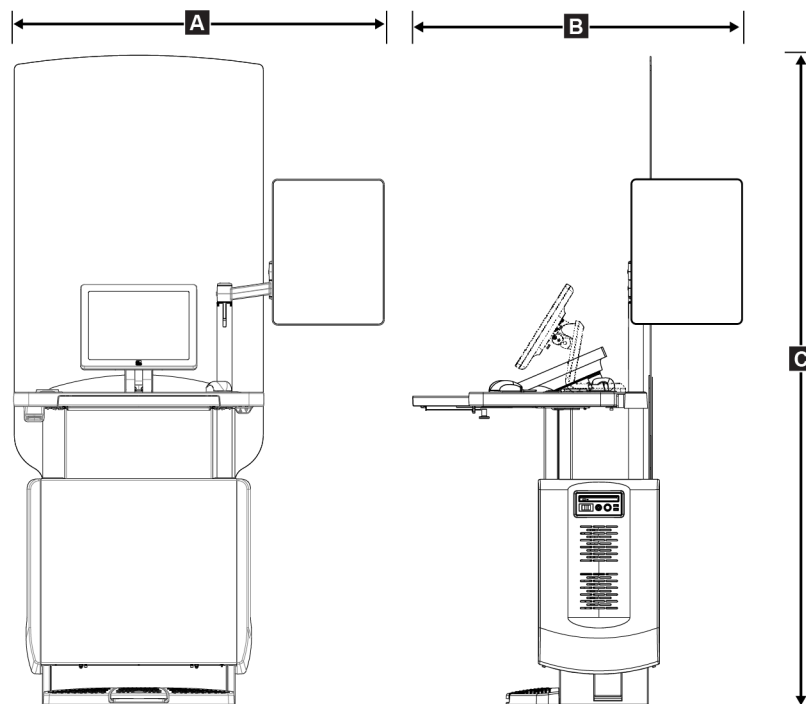


Figure 103: Universal Acquisition Workstation Measurements

A.	Width (maximum) with optional articulated display arm extended	136 cm (53.4 inches) - series I UAWS 128 cm (50.3 inches) - series II UAWS
	Width (maximum) with standard display arm	94.0 cm (36.9 inches) - series I UAWS 107 cm (42.0 inches) - series II UAWS
B.	Depth (maximum) with keyboard tray extended and optional articulated display monitor arm	122 cm (48.4 inches) - series I UAWS, rotated to the side 115 cm (45.1 inches) - series II UAWS, rotated to the side
	Depth (maximum) with keyboard tray extended and standard display arm	83.6 cm (32.9 inches) - series I and II UAWS
C.	Height (nominal)	219 cm (86.1 inches) after August 2017 204 cm (80.3 inches) before September 2017
	Weight (maximum)	209 kg (460 pounds)

### Premium Acquisition Workstation

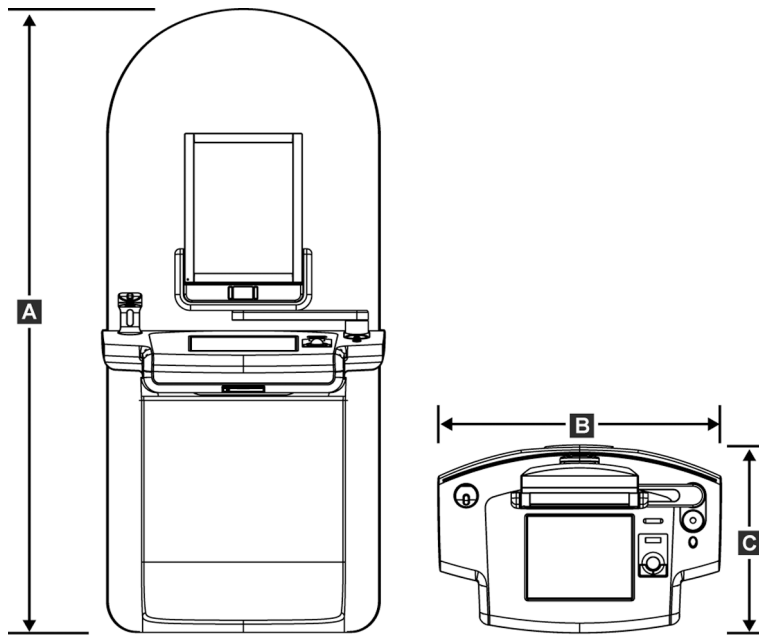


Figure 104: Premium Acquisition Workstation Measurements

A.	Height	202 cm (79.8 inches)
B.	Width	92.7 cm (36.5 inches)
C.	Depth	58.5 cm (23.0 inches)
	Weight	154 kg (340 pounds)

### Standard Acquisition Workstation

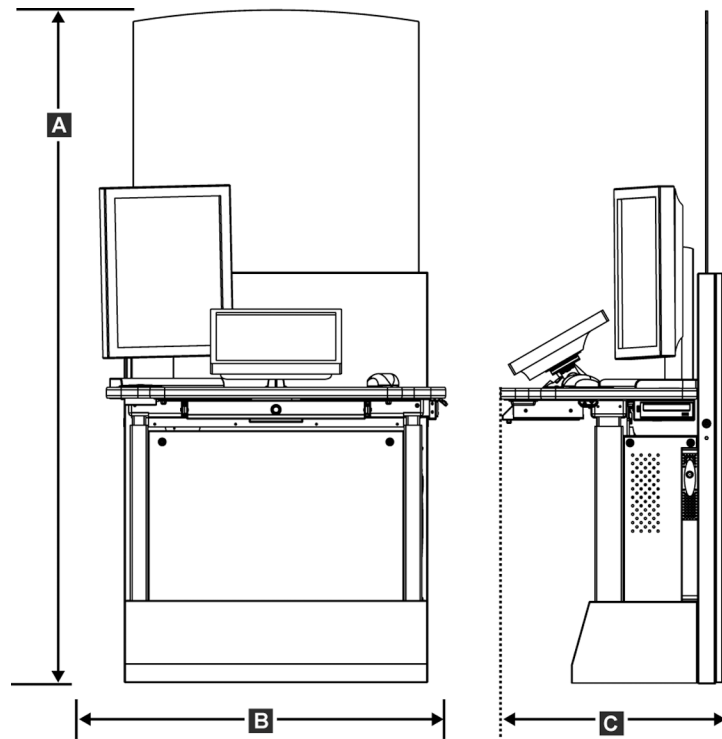


Figure 105: Standard Acquisition Workstation Measurements

A.	Height	192 cm (75.3 inches)
B.	Width	107 cm (42.1 inches)
C.	Depth	76.2 cm (30.0 inches)
	Weight	219 kg (462 pounds)

Acquisition Workstations for Mobile Use

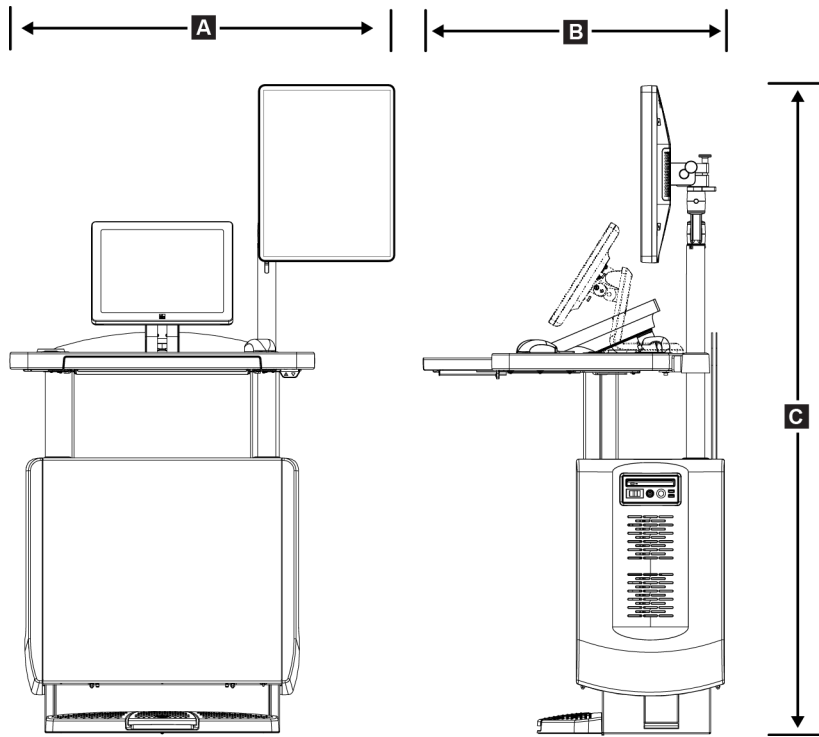


Figure 106: Mobile Universal Acquisition Workstation Measurements

A.	Width (maximum) with mobile display arm	100 cm (39.5 inches) - series I UAWS 107 cm (42.0 inches) - series II UAWS
B.	Depth (maximum) with keyboard tray extended	85 cm (33.5 inches)
C.	Height (maximum)	180 cm (71 inches)
	Weight (maximum)	179 kg (395 pounds)

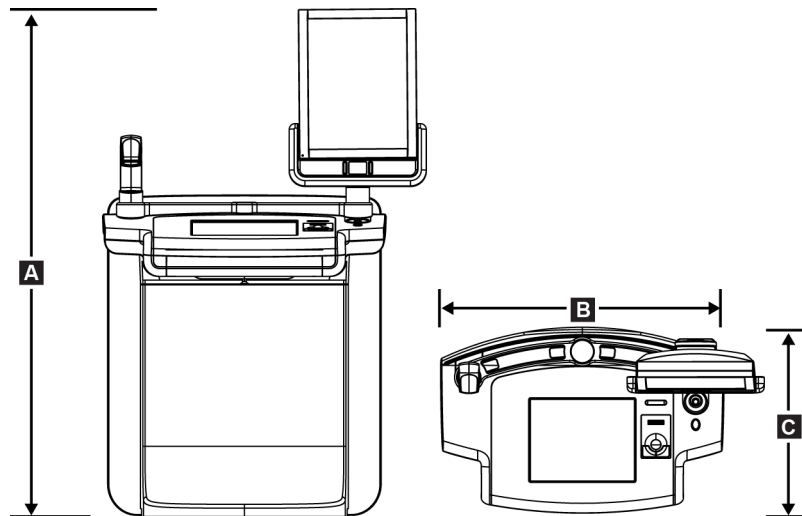


Figure 107: Mobile Premium Acquisition Workstation Measurements

A. Height	167.6 cm (66.0 inches)
B. Width	105.5 cm (41.5 inches)
C. Depth	58.5 cm (23 inches)
Weight	154 kg (340 pounds)

## A.2 Operation and Storage Environment

### A.2.1 General Conditions for Operation

Temperature Range	20 °C (68 °F) to 30 °C (86 °F)
Relative Humidity Range	20% to 80% without condensing moisture

### A.2.2 Storage Environment

#### Gantry

Temperature Range	-10 °C (14 °F) to 40 °C (104 °F)
Relative Humidity Range	0% to 95% without condensing moisture

(Put in a package for storage in a building.)



### **X-ray Detector**

<i>Temperature Range</i>	<i>10 °C (50 °F) to 30 °C (86°F) indefinitely</i> <i>10 °C (50 °F) to 35°C (95 °F) for a maximum of 12 hours</i>
<i>Maximum rate of temperature change</i>	<i>Less than 10 °C (50 °F) per hour</i>
<i>Relative Humidity Range</i>	<i>10% to 80% without condensing moisture</i>
<i>(Put in a package for storage in a building.)</i>	

### **Acquisition Workstation**

<i>Temperature Range</i>	<i>-10 °C (14 °F) to 40 °C (104 °F)</i>
<i>Relative Humidity Range</i>	<i>0% to 95% without condensing moisture</i>
<i>(Put in a package for storage in a building.)</i>	

## **A.3 Radiation Shield**

<i>Radiation Shield Lead (Pb) equivalent</i>	<i>0.5 mm lead for x ray energy to 35 kV</i>
--	--

## **A.4 Electrical Input**

### **A.4.1 Tubestand**

<i>Mains Voltage</i>	<i>200/208/220/230/ 240 VAC ±10%</i>
<i>Mains Impedance</i>	<i>Maximum line impedance not to exceed 0.20 ohms for 208/220/230/240 VAC, 0.16 ohms for 200 VAC</i>
<i>Mains Frequency</i>	<i>50/60 Hz ±5%</i>
<i>Average Current over 24 Hours</i>	<i>&lt; 5 A</i>
<i>Peak Line Current</i>	<i>4 A (65 A maximum for ≤ 5 seconds)</i>

### **A.4.2 Acquisition Workstation**

<i>Mains Voltage</i>	<i>100/120/200/208/220/230/240 VAC ±10%</i>
<i>Mains Frequency</i>	<i>50/60 Hz ±5%</i>
<i>Power Consumption</i>	<i>&lt; 1000 watts</i>
<i>Duty Cycle (Standard Acquisition Workstation)</i>	<i>10% ~ 6 minutes per hour or 2 minutes on, 18 minutes off</i>
<i>Overcurrent Protection</i>	<i>8A</i>

## **A.5 Tubestand Technical Information**

### **A.5.1 C-Arm**

<i>Rotation Range</i>	<i>Conventional Mammography:</i> $+195^{\circ} +3^{\circ}/-0.5^{\circ}$ to $0^{\circ} \pm 0.5^{\circ}$ to $-155^{\circ} +0.5^{\circ}/-3^{\circ}$  <i>Tomosynthesis option:</i> $+180^{\circ} \pm 0.5^{\circ}$ to $0^{\circ} \pm 0.5^{\circ}$ to $-140^{\circ} \pm 0.5^{\circ}$
<i>Absolute Angular Position</i>	<i>accurate to <math>\pm 0.5^{\circ}</math></i>
<i>Rotation Acceleration</i>	$18^{\circ}/s^2 +18/-9\%$
<i>Rotation Deceleration</i>	$18^{\circ}/s^2 +18/-9\%$
<i>Rotational Positioning Angular Velocity</i>	$18^{\circ}/s \pm 25\%$




---

**Note**

The angular velocity is the average of the velocity of the tube arm rotating clockwise between  $0^{\circ}$  and  $90^{\circ}$  or rotating counterclockwise between  $90^{\circ}$  and  $0^{\circ}$ . The angular velocity does not include the time to accelerate from zero velocity and decelerate to zero velocity.

---

<i>Source-to-Image Distance (SID)</i>	$70.0\text{ cm} \pm 1.0\text{ cm}$ (27.6 inches $\pm 0.4$ inches)  (Focus position deviation is $\pm 5\text{ mm}$ )
<i>Patient Support (non-magnification)</i>	
<i>Vertical Position Lower Limit</i>	$70.5\text{ cm} +5.1/-0\text{ cm}$ (27.75 inches $+2.0/-0$ inches)
<i>Vertical Position Upper Limit</i>	$141\text{ cm} +0/-17.8\text{ cm}$ (55.5 inches $+0/-7.0$ inches)

## A.5.2 Compression

<i>Manual Compression Force</i>	<i>Maximum of 300 N (67.4 pounds)</i>
<i>Motorized Compression</i>	<i>Functions in three operating modes: Pre-compression, Full-Range, Dual Compression. User selectable through software.</i>
<i>Pre-Compression Force</i>	<i>15 pounds to 30 pounds (67 to 134 N), motorized</i>
<i>Full Range Compression Force</i>	<i>20 pounds to 40 pounds (89 to 178 N), motorized</i>
<i>Dual Mode Compression</i>	<i>Provides Pre-Compression force upon first activation of compression switch; then, if switch is activated within 2 seconds, the force is increased incrementally for each additional switch activation, up to the user selected full compression force.</i>
<i>Compression Controls</i>	<i>Up/Down controls on both sides of C-arm and on 2-position footswitch (Motorized). Handwheel on both sides of Compression Device (Manual).</i>
<i>Compression Release</i>	<i>Manual Motorized Release controlled by push-buttons on both sides of the C-arm.</i>
<i>Automatic Compression Release</i>	<i>User selectable automatic release mode raises Compression Device upon exposure termination.</i>
<i>Down Motion Variable Speed</i>	<i>4.2 cm/s <math>\pm</math>15% (1.66 inches/s <math>\pm</math>15%)</i>
<i>Compression Force Display</i>	<i>Two LCDs on the Compression Device show the compression force through the range of 18 N to 300 N in 1 N increments (4 pounds to 67 pounds in 1 pound increments).</i>
<i>Compression Force Display Accuracy</i>	<i><math>\pm</math>20 N (<math>\pm</math>4.5 pounds)</i>
<i>Compression Thickness Display</i>	<i>Two LCDs on the Compression Device measure compression thickness in 0.1 cm increments. The display is visible from both sides of the patient.</i>
<i>Compression Thickness Accuracy</i>	<i><math>\pm</math>0.5 cm (<math>\pm</math>0.2 inches) for thicknesses between 0.5 cm and 15 cm (5.9 inches)</i>
<i>Breast Tomosynthesis Compression Thickness</i>	<i>Standard resolution tomosynthesis Maximum: 24 cm (restricted by compression device geometry) High resolution tomosynthesis Maximum: 15 cm (restricted by DICOM limitations)</i>
<i>Compression Paddles</i>	<i>Compression Paddles are transparent. The paddles are composed of polycarbonate resin or the equivalent. With compression applied, paddle deflection from a plane parallel to the patient support surface shall be less than or equal to 1.0 cm.</i>

# Selenia Dimensions System User Guide

## Appendix A: Specifications

---

### A.5.3 X-ray Tube

<i>Focal Spot</i>	<i>Large (0.3 mm) Nominal</i> <i>Small (0.1 mm) Nominal</i>
<i>Tube Voltage</i>	<i>20 kV to 49 kV</i>
<i>Anode Material</i>	<i>Tungsten</i>
<i>X-Ray Window</i>	<i>Beryllium 0.63 mm</i>
<i>Tube leakage test conditions</i>	<i>49 kVp, 2.0 mA</i>

### A.5.4 X-ray Beam Filtration and Output

<i>Filtration</i>	<i>Five-position filter wheel:</i> <i>Position 1: Rhodium, 0.050 mm ±10%</i> <i>Position 2: Aluminum, 0.70 mm (nominal) (Tomosynthesis option)</i> <i>Position 3: Silver, 0.050 mm ±10%</i> <i>Position 4: Copper, 0.3mm</i> <i>Position 5: Lead (provided for servicing)</i>
-------------------	--

#### kV/mA Range

*Table 21: Maximum mA Setting as a Function of kV*

<b>kV</b>	<b>LFS mA</b>	<b>SFS mA</b>
20	100	30
21	110	30
22	110	30
23	120	30
24	130	30
25	130	40
26	140	40
27	150	40
28	160	40
29	160	40
30	170	50
31	180	50

Table 21: Maximum mA Setting as a Function of kV

kV	LFS mA	SFS mA
32	190	50
33	200	50
34	200	50
35	200	50
36	190	50
37	180	50
38	180	50
39	180	50
40	170	
41	170	
42	160	
43	160	
44	150	
45	150	
46	150	
47	140	
48	140	
49	140	

*mAs Steps (Table 1, default)*

4, 5, 6, 7, 8, 9, 10, 12, 14, 16, 18, 20, 22, 25, 30, 32.5, 35, 37.5, 40, 42.5, 45, 47.5, 50, 52.5, 55, 57.5, 60, 62.5, 65, 67.5, 70, 75, 80, 85, 90, 95, 100, 120, 140, 160, 180, 200, 220, 240, 260, 280, 300, 320, 340, 360, 380, 400, 420, 440, 460, 480, 500

**Attenuation of Carbon Fiber**

*Image Receptor* < 0.3 mm Al

*Magnification Platform* < 0.3 mm Al

### A.5.5 X-ray Collimation

<i>Collimation Fields</i>	<i>7.0 cm x 8.5 cm</i>
	<i>10 cm x 10 cm</i>
	<i>15 cm x 15 cm</i>
	<i>18 cm x 24 cm</i>
	<i>18 cm x 29 cm (Tomosynthesis option)</i>
	<i>24 cm x 29 cm</i>

### A.5.6 Light Field Indication

<i>Light Field to X Ray Congruency</i>	<i>Within 2% of SID</i>
--	-------------------------

### A.5.7 X-ray Generator

<i>Type</i>	<i>Constant Potential High Frequency Inverter</i>
<i>Rating</i>	<i>7.0 kW, maximum (isowatt), 200 mA at 35 kV</i>
<i>Electrical Power Capacity</i>	<i>9.0 kW maximum</i>
<i>kV Range</i>	<i>20 kV to 49 kV in 1 kV increments</i>
<i>kV accuracy</i>	<i>±2%, over range 20-49 kVp</i>
<i>mAs Range</i>	<i>3.0 mAs to 500 mAs in Manual Mode mAs (8 mAs minimum in AEC Mode)</i>
<i>mAs Accuracy</i>	<i>±(10% + 0.2 mAs)</i>
<i>mA Range</i>	<i>10 mA to 200 mA, Large Focal Spot</i>
	<i>10 mA to 50 mA, Small Focal Spot</i>

## A.6 Imaging System Technical Information

### A.6.1 Image Receptor

<i>Fluid Ingress</i>	<i>No fluid from accidental spillage on the Image Receptor may seep inside.</i>
<i>Deflection</i>	<i>Does not exceed 1.0 mm at maximum compression.</i>
<i>Active Imaging Area</i>	<i>Not less than 23.3 cm by 28.5 cm (9.2 inches x 11.2 inches)</i>
<i>DQE Conventional Mammography</i>	<i>Not less than 50% at 0.2 lp/mm</i> <i>Not less than 15% at the Nyquist limit</i>
<i>DQE (Tomosynthesis option)</i>	<i>Not less than 30% at 0.2 lp/mm</i> <i>Not less than 15% at the Nyquist limit</i>
<i>Dynamic Range and Linearity</i>	<i>Detector Subsystem response is linear with linearity of 0.999 over a dynamic range of 400:1 in x-ray exposure.</i>
<i>Uniformity</i>	<i>Detector Subsystem can correct pixel-to-pixel gain variations.</i> <i>For conventional mammography procedures, the uniformity of flat field image response of the detector shall be no greater than 2% after gain calibration is applied over an exposure range of 0.5 mR to 200 mR.</i>





## Appendix B System Messages and Alert Messages

### B.1 Error Recovery and Troubleshooting

Most faults and alert messages are cleared without result to your workflow. Follow the instructions on the screen or fix the condition then clear the status from the Taskbar. Some conditions require a system restart or indicate that more action is necessary (for example, to call Hologic Technical Support). This appendix describes the message categories and your actions to return the system to normal operation. If errors repeat, contact Hologic Technical Support.

### B.2 Types of Messages

#### B.2.1 Fault Levels

Each Message has a particular set of the following characteristics:

- Aborts an exposure in progress (yes/no)
- Prevents an exposure from starting (yes/no)
- Displays a message to the user on the Acquisition Workstation (yes/no)
- May be reset by the user (yes/no)
- May be reset automatically by the system (yes/no)

#### Displayed Messages

All displayed messages will be shown in the user's selected language.

Any message which aborts an exposure or prevents an exposure from starting will always display a message directing the user's actions required to proceed.

#### Additional Message Information

Technical information about the message is available in the log file.

Some messages always show as a critical fault (a system restart is necessary). These messages result from a condition which prevents an exposure, and which cannot be reset by the user or the system.

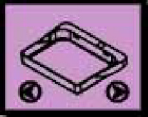
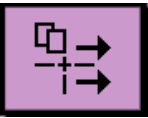




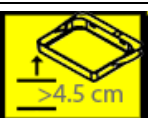
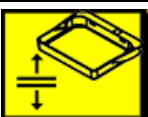


# Selenia Dimensions System User Guide

## Appendix B: System Messages and Alert Messages









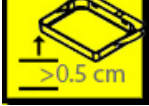
### B.2.2 System Messages

When the following system messages show, do the step shown in the User Action column to clear the message and allow the next exposure.

Table 22: System Messages

Icon	Message	User Action
	Paddle is moving	No action needed.
	Sending notice	No action needed.
	Invalid use of Magnification Stand	You selected a tomographic view with the Magnification Stand installed. Select a non-tomographic view. (Tomosynthesis option)
	Face shield is not secured	Fully extend or fully retract the Face Shield. (Tomosynthesis option)
	Invalid use of compression paddle	Remove the Magnification Stand or install the Magnification Paddle.
	Paddle position does not match selected view	Shift the Paddle to the correct location for the selected view.
	Compression is less than 4.5 cm during calibration	Move the Compression Paddle higher than 4.5 cm to complete the calibration procedure.
	FAST compression is engaged	Disengage FAST compression and install a paddle designated for this mode.
	License is missing	A license is necessary to use this feature or function. (This message is for your information only. There are no user actions.)
	Invalid detector calibration	Install the Magnification Stand for Small Focal Spot calibration. Remove the Magnification Stand to do Large Focal Spot calibration.

*Table 22: System Messages*

Icon	Message	User Action
	Invalid geometry calibration	Repeat the geometry calibration before you try to take an exposure. (Tomosynthesis option)
	Configuration file is missing	Applies to Service Personnel.
	Waiting for Detector	No action needed.
	System in Test Mode	Applies to Service Personnel.
	Tube needs to be manually positioned (move to 0 degrees)	Rotate the C-arm to 0 degrees.
	Tube needs to be manually positioned (move to -15 degrees)	Rotate the C-arm to -15 degrees.
	Tube needs to be manually positioned (move to 15 degrees)	Rotate the C-arm to +15 degrees.
	The Emergency Stop switch has been engaged.	Turn the Emergency Off switch one-quarter turn to reset the switch.
	Compression too low for tomo reconstructions.	Move the Compression Paddle higher than 0.5 cm to take tomography exposures.

### B.3 UPS Messages

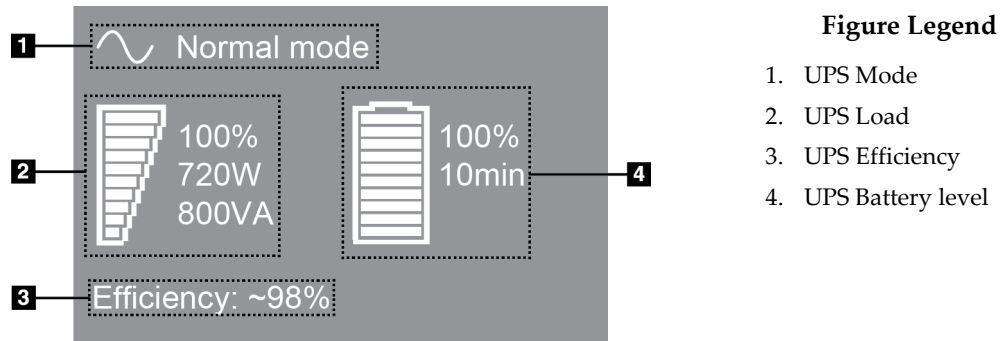


**Note**

The User Guide for the UPS is supplied with the system. Refer to the *UPS User Guide* for complete instructions.

---

The LCD in the UPS shows the power status.



*Figure 108: UPS LCD Display*

If the UPS battery expires, the Mode icon changes as shown. Contact your service representative to replace the battery.



## Appendix C Use of Mobile System

This appendix describes the system installed in a mobile environment.

### C.1 Conditions for Safety and Other Precautions

An acceptable, stable, clean VAC power source is required to make sure that the system meets all its performance specifications. Where available, shore power correctly supplied to the system provides the best performance. If a mobile power generator is used, you must keep the specifications for input power during all load conditions.



**Warning:**

**The radiation shield is not approved for mobile use and is not provided. The coach manufacturer must provide adequate shielding.**

---



**Caution:**

When shore power is unavailable, mobile power sources that provide equivalent performance may be employed. (Refer to [Specifications for Mobile Use](#) on page 158.) Proper system function and performance can only be ensured if continuous true sinusoidal VAC power is supplied per the system power input specifications and loading characteristics. Intermittently, the power source must provide 65 Amps at 208 VAC for a minimum of 5 seconds, and 4 Amps maximum continuous otherwise. This load must be supported once every 30 seconds. In the event of shore or mobile power service interruption, the UPS must be capable of providing the operational power described above for a minimum of 4 minutes. Acquisition Workstation and Gantry power must be fed on separate dedicated circuits. The use of an uninterruptible power supply with active line conditioner is recommended on each power circuit. Accordingly, all ancillary mobile coach power should be distributed by other circuits. The electrical installation must be verified to meet system power input specifications and IEC 60601-1 safety requirements after initial installation and upon each relocation of the mobile coach.

---



**Caution:**

**The temperature and humidity inside the vehicle must be maintained at all times. Do not allow environmental conditions to exceed stated specifications when the unit is not in use.**

---



**Caution:**

**Voltages cannot change by more than  $\pm 10\%$  when the x-ray unit or other equipment (for example, heating or air conditioning) is operated.**

---



### Caution

To avoid image artifacts from occurring:

- Care should be exercised not to locate or park the mobile coach near sources of high power (such as power transmission lines and outdoor transformers).
  - Make sure that any mobile power generator, uninterruptible power system (UPS), or voltage stabilizer is at least 3 meters (10 feet) from the closest point of the image detector travel.
- 

## C.2 Specifications for Mobile Use

The following system specifications are for mobile use only. For all other specifications, refer to the section [Specifications](#) on page 139.

### C.2.1 Shock and Vibration Limits

*Vibration Limit*

*Maximum of 0.30 G (2 Hz to 200 Hz), measured at the point where the system mounts to the coach.*

*Shock Limit*

*Maximum of 1.0 G (1/2 sine pulse), measured at the point where the system mounts to the coach. An "air ride" coach suspension is recommended.*

### C.2.2 Coach Environment

#### Operation Environment

*Temperature Range*

*20 °C (68 °F) to 30 °C (86 °F)*

*Relative Humidity Range*

*20% to 80% without condensing moisture*

#### Non-operating/Transit Environment

*Temperature Range*

*10 °C (50 °F) to 35 °C (95 °F) for a maximum of 12 hours*

*10 °C (50 °F) to 30 °C (86 °F) indefinitely*

*Maximum Rate of Temperature Change*

*<10 °C/hr.*

*Relative Humidity Range*

*10% to 80% without condensing moisture*

## C.3 Electrical Input

### C.3.1 Gantry

<i>Mains Voltage</i>	200/209/220/230/ 240 VAC $\pm 10\%$
<i>Mains Impedance</i>	<i>Maximum line impedance not to exceed</i> 0.20 ohms for 208/220/230/240 VAC, 0.16 ohms for 200 VAC
<i>Mains Frequency</i>	50/60 Hz $\pm 5\%$
<i>Average Current over 24 Hours</i>	< 5 A
<i>Peak Line Current</i>	4 A (65 A maximum for 3 seconds)

### C.3.2 Acquisition Workstation

<i>Mains Voltage</i>	100/120/200/ 208/220/230/ 240 VAC $\pm 10\%$
<i>Mains Frequency</i>	50/60 Hz $\pm 5\%$
<i>Power Consumption</i>	< 1000 watts

### C.4 Prepare the System for Travel

Before travel, perform these steps:

1. Rotate the C-arm to 0 degrees (CC position).
2. Lower the C-arm to its lowest position.
3. Turn off the system through the user interface.
4. Place the mouse in the keyboard tray.
5. Lock the keyboard tray (see the following figures):
  - a. Close the tray.
  - b. Find the lock knob under the tray.

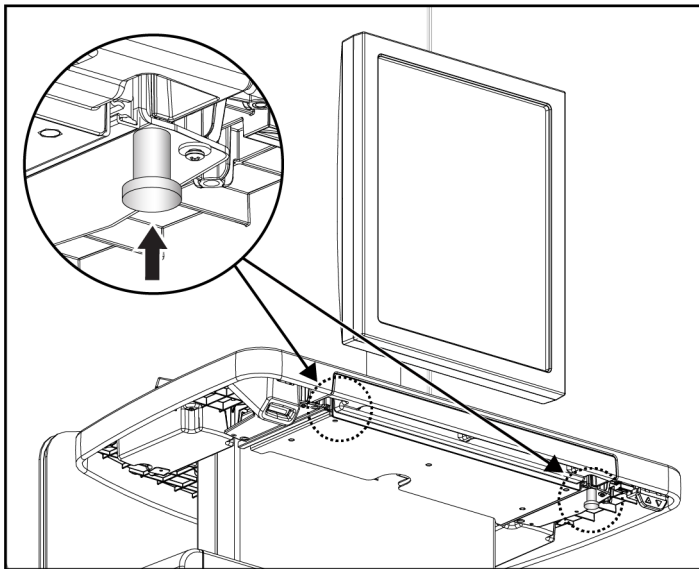


Figure 109: Keyboard Tray Lock Knob, Right or Left Side (Universal Acquisition Workstation)

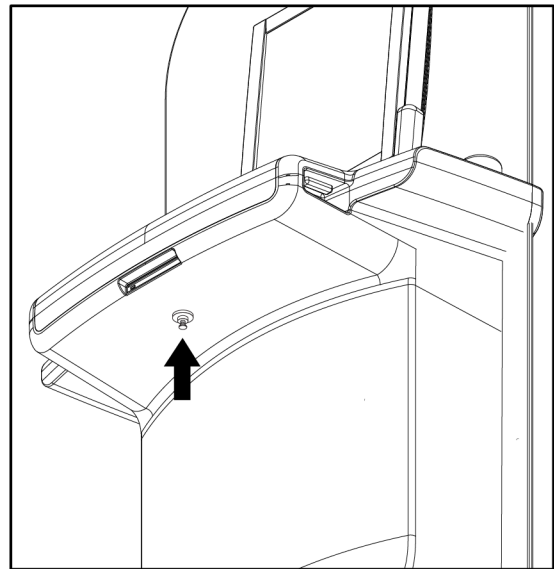


Figure 110: Keyboard Tray Lock Knob (Premium Workstation)

- c. Turn the lock knob 90° until the knob fits into the lock. Position A in the following figure shows the locked position.

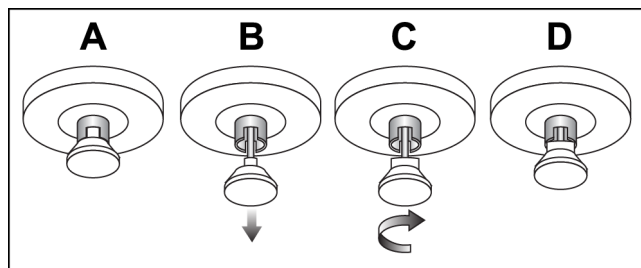


Figure 111: Tray Lock Release from Locked (A) to Unlocked (D)



6. If using the mobile Universal Acquisition Workstation, lock the swivel monitor using the knobs provided (see the following figures).

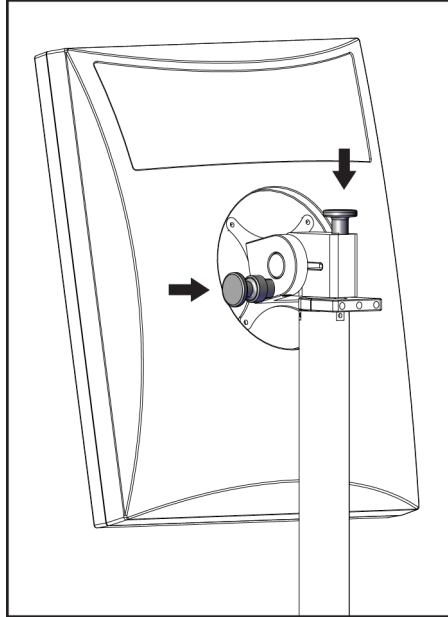


Figure 112: Swivel Lock Knobs for the Image Display Monitor on the Mobile Universal Acquisition Workstation (series I)

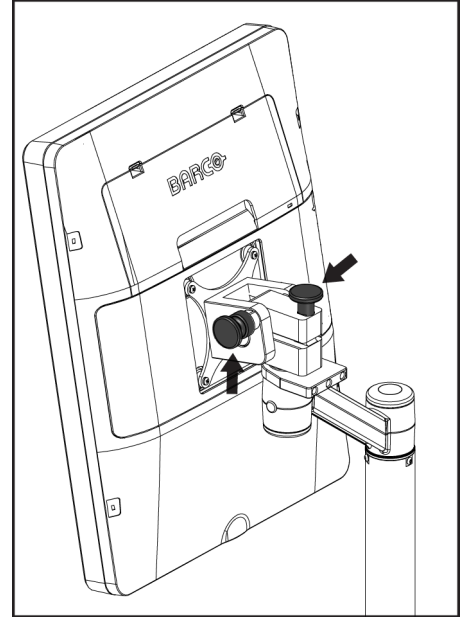
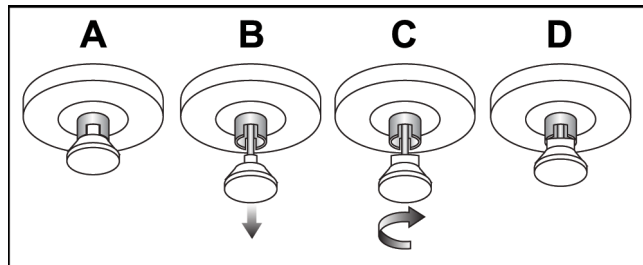


Figure 113: Swivel Lock Knobs for the Image Display Monitor on the Mobile Universal Acquisition Workstation (series II)

7. Lower the work surface to the minimum height.
8. Remove all system accessories.
9. Put all accessories in a safe storage area.

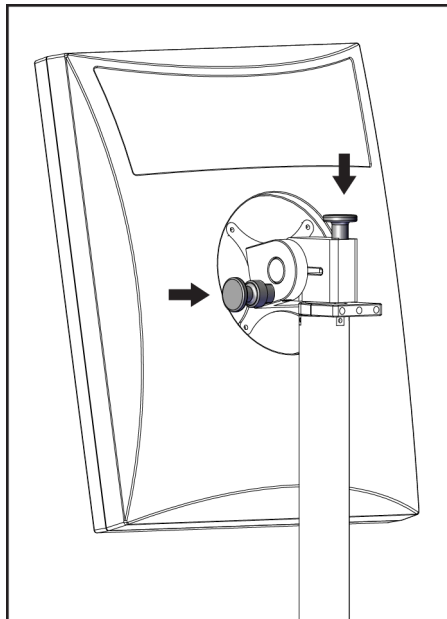
## **C.5 Prepare the System for Use**

1. Unlock the keyboard tray:
  - a. Find the lock knob under the tray.
  - b. Pull the knob down.
  - c. Turn the knob 90°. This position keeps the latch open. Position D (in the following figure) shows the unlocked position.

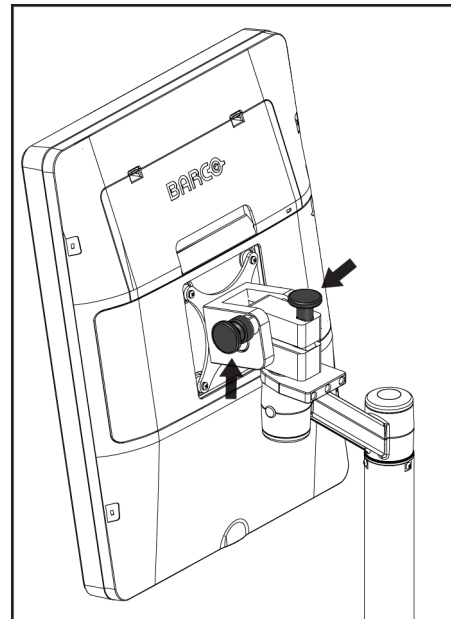


*Figure 114: Tray Lock Release from Locked (A) to Unlocked (D)*

2. Pull the tray out, if needed.
3. If using the mobile Universal Acquisition Workstation, unlock the swivel display (see the following figure).



*Figure 115: Swivel Lock Knobs for the Image Display Monitor on the Mobile Universal Acquisition Workstation (series I)*



*Figure 116: Swivel Lock Knobs for the Image Display Monitor on the Mobile Universal Acquisition Workstation (series II)*

## **C.6 Test the System after Travel**

### **C.6.1 Mobile System Controls and Functional Tests**

To test the mechanical integrity of a mobile system, perform the Controls and Functional tests. Refer to [Perform the Functional Tests](#) on page 38.

- Compression Up/Down
- Compression Release
- C-arm Rotation
- C-arm Up/Down
- Collimator Override
- Light Field Lamp
- Shifting Paddle System
- Emergency Off Switches

Do the Controls and Functional tests each time the mobile system is relocated.

### **C.6.2 Quality Control for Mobile Systems**

To verify the performance integrity of a mobile system, perform the following quality control tests:

- Artifact Evaluation
- SNR/CNR Measurement
- Phantom Image Evaluation
- Compression Thickness

Do the quality control tests each time the mobile system is relocated.



## Appendix D Dose Information

### D.1 EUREF Dose Tables



#### Notes

This information is only applicable for the European Union.

The following values are for the default dose tables.

The following tables show typical dose values when operating the system in 2D and in BT imaging modes. All dose values have a tolerance of  $\pm 30\%$ . The tables follow the procedures given in the *European guidelines for quality assurance in breast cancer screening and diagnosis, Fourth edition*: section 2a.2.5.1 **Dosimetry**, and **Appendix 5: Procedure for determination of average glandular dose**.

Table 23: 2D Dose (EUREF)

Phantom	cm	kV	Anode	Filter	EUREF dose (mGy)
2.0 cm PMMA	2.1	25	W	0.05 mm Rh	0.55
3.0 cm PMMA	3.2	26	W	0.05 mm Rh	0.75
4.0 cm PMMA	4.5	28	W	0.05 mm Rh	1.05
4.5 cm PMMA	5.3	29	W	0.05 mm Rh	1.42
5.0 cm PMMA	6	31	W	0.05 mm Rh	2
6.0 cm PMMA	7.5	31	W	0.05 mm Ag	2.7
7.0 cm PMMA	9	34	W	0.05 mm Ag	3.1

Table 24: BT Dose (EUREF)

Phantom	cm	kV	Anode	Filter	EUREF dose (mGy)
2.0 cm PMMA	2.1	26	W	0.7 mm Al	
3.0 cm PMMA	3.2	28	W	0.7 mm Al	1.15
4.0 cm PMMA	4.5	30	W	0.7 mm Al	1.5
4.5 cm PMMA	5.3	31	W	0.7 mm Al	2.00
5.0 cm PMMA	6	33	W	0.7 mm Al	2.5
6.0 cm PMMA	7.5	36	W	0.7 mm Al	3.9
7.0 cm PMMA	9	42	W	0.7 mm Al	5.15

## Selenia Dimensions System User Guide

### Appendix D: Dose Information

---

Table 25: CEDM Dose (EUREF)

Phantom	cm	kV	Anode	Filter	EUREF dose (mGy)
2.0 cm PMMA	2.1	26/45	W	0.05/0.3 mm Rh/Cu	0.83
3.0 cm PMMA	3.2	26/45	W	0.05/0.3 mm Rh/Cu	1.1
4.0 cm PMMA	4.5	28/45	W	0.05/0.3 mm Rh/Cu	1.6
4.5 cm PMMA	5.3	29/49	W	0.05/0.3 mm Rh/Cu	2.1
5.0 cm PMMA	6	31/49	W	0.05/0.3 mm Rh/Cu	3.0
6.0 cm PMMA	7.5	32/49	W	0.05/0.3 mm Ag/Cu	4.1
7.0 cm PMMA	9	33/49	W	0.05/0.3 mm Ag/Cu	4.7

## Glossary of Terms

### **ACR**

American College of Radiology

### **AEC**

Automatic Exposure Control

### **Annotations**

Markings on an image to indicate an area of interest.

### **BT**

Breast Tomosynthesis. An imaging procedure that provides information about the breast in three dimensions

### **CEDM**

Contrast Enhanced Digital Mammography

### **Collimator**

A device at the x-ray tube to control the x-ray beam exposure area.

### **Conventional Mammography**

Single projection x-ray images of views for screening and diagnostic purposes

### **C-View**

A licensed Hologic feature where a digital mammography (DM) image is generated from data acquired during a breast tomosynthesis (BT) scan

### **DICOM**

Digital Imaging and Communications in Medicine

### **DM**

Digital Mammography (2D)

### **EMC**

Electromagnetic Compatibility

### **FAST Paddle**

Fully Automatic Self-adjusting Tilt Paddle

### **FDA**

Food and Drug Administration (in the United States)

### **Grid**

An element within the Digital Image Receptor that reduces scatter radiation during the exposure

### **Image Receptor**

Assembly of the x-ray detector, x-ray scatter reduction grid, and carbon fiber cover

### **Intelligent 2D**

A licensed Hologic feature where a high-resolution digital mammography (DM) image is generated from data acquired during a high resolution breast tomosynthesis (BT) scan

### **I-View**

A licensed feature for 2D Contrast Enhanced Digital Mammography

### **MPPS**

Modality Performed Procedure Step

### **MQSA**

Mammography Quality Standards Act

### **Notice**

Annotations and comments per image communicated between Diagnostic Review Workstations, Technologist Workstations, and Acquisition Workstations

### **PACS**

Picture Archiving and Communications System. A computer and network system that transmits and archives digital medical images.

### **Pend**

The action taken on an image to mark the image if the Technologist is not positive about the image quality (pending images must be Accepted or Rejected before the procedure is closed)

### **Projection Image**

One of a group of breast tomosynthesis images taken at different projection angles and used to produce the final reconstructed image

### **Reclamation**

Automatic removal of patient images and related information to allow storage of new patient image acquisitions

### **RF**

Radio Frequency

### **ROI**

Region of Interest

### **SID**

Source to Image Distance

### **Tomosynthesis**

An imaging procedure that combines a number of breast images taken at different angles. The tomosynthesis images can be reconstructed to show focal planes (slices) within the breast.

### **UDI**

A United States Food and Drug Administration program for Unique Device Identification (UDI). For more information about UDI, go to <http://www.fda.gov/MedicalDevices/DeviceRegulationandGuidance/UniqueDeviceIdentification/UDIBasics/default.htm>.

### **UPS**

Uninterruptible Power Supply

### **USB**

Universal Serial Bus



## Index

### 2

- 2D contrast
  - 2D contrast settings • 88, 128

### A

- about (acquisition workstation) screen • 121
  - accept images • 77, 79, 127
  - accept rejected images • 79
  - accessories • 91
    - compression paddles • 94
    - crosshair devices • 104
    - face shields • 92
    - install on C-arm • 91
    - magnification stand • 102
  - acquire images • 77, 109
  - acquisition modes • 76
  - Acquisition Workstation
    - about (acquisition workstation) screen • 121
    - controls • 30
    - controls and displays • 30, 31
    - maintenance • 114
    - touchscreen • 30, 32
  - add
    - new patient • 54
    - procedure • 65
    - view • 66
  - admin screen
    - about (acquisition workstation) screen • 121
    - admin button • 59
  - alerts • 153
  - archive • 71
  - auto-hanging, auto-pairing • 123
  - Automatic Exposure Control
    - buttons • 27
    - Sensor position • 27
  - auto-rotation • 45
- ### B
- bar code scanner • 30, 32

### C

- C-arm
  - auto-rotation • 45
  - controls and indicators • 26, 28
  - displays • 27
  - rotation and movement • 40
  - slots for accessories • 91
- cine tab • 83
- circuit breaker
  - Gantry • 25
- clinical procedures • 107
- close
  - patient • 68
  - procedure • 68
- collimator
  - override • 46
  - programmed to paddle • 94
  - programmed to paddle position • 38
- columns tab • 59
- comments tab • 83
- compression
  - controls and displays • 27
  - FAST compression mode • 100
  - paddles • 94
  - release • 109
  - specifications • 147
- compression force, range • 27
- computer power button • 25
- contact paddles • 97
- contrast settings • 88, 128
- controls
  - Acquisition Workstation • 29, 30, 31
  - C-arm • 28
  - collimator override • 38, 46
  - compression • 28, 38, 39
  - compression brake • 38, 39
  - footswitches, AWS • 28
  - Gantry Tubestand • 26
  - handwheels • 27
  - indicators • 25
  - light field lamp • 38, 46
  - manual compression release • 38, 39
  - system • 25

conventional face shield, install • 94  
custom output • 70  
cybersecurity statement • 8

## D

data loss • 14  
delete patient • 57  
display  
    Acquisition Workstation • 30  
    clean • 114  
    compression force • 27  
    preview image • 32, 75  
    thickness • 27  
    types of images selection • 83  
    window level • 81  
dose information • 165  
    EUREF dose tables • 165

## E

edit  
    patient information • 54  
    user information • 50  
Emergency Off Switch • 19, 26, 30  
    functional test • 38  
export • 72  
exposure  
    parameters • 76  
    sequence • 109  
    techniques, set • 76

## F

face shield • 92  
FAST compression mode • 100  
faults • 153  
filter tab • 58  
    other functions • 58  
fingerprint scanner - AWS • 30  
footswitches, AWS • 28  
functional tests • 38  
    Emergency Off Switch • 19, 38, 47

## G

generator tab, set techniques • 76

## H

Hologic technical support • 113

## I

images  
    accept • 77, 79  
    acquisition mode • 76  
    output options • 84  
    preview • 75  
    reject • 77  
    review tools • 68, 81  
    store • 77  
Implant Present button • 62  
indicators • 25  
install  
    compression paddles • 99  
    conventional face shield • 94  
    localization crosshair device • 104  
    magnification crosshair device • 105  
    Magnification Stand • 102  
    retractable face shield • 92  
Intelligent 2D • 4  
international symbols • 9

## K

keyboard • 30, 32

## L

label locations • 23  
laser film printer, isolation requirements • 14  
light field lamp • 38  
    use • 109  
localization crosshair device  
    align • 106  
    install and remove • 104  
    use • 105  
localization paddles • 98  
Log Out • 59

## M

- magnification crosshair device, install and remove
  - 105
- magnification paddles • 97
- Magnification Stand • 102
  - install and remove • 102
- maintenance
  - general • 113
- manage
  - alarms • 50
  - notices • 50
  - output groups • 69
- messages and alerts • 153
- mobile system
  - prepare for travel • 160
  - prepare for use • 162
  - safety • 157
  - specifications • 158
  - test after travel • 163
- My Settings icon • 50

## N

- needle localization • 111
- Notices tab • 83

## O

- on-demand outputs • 71
- open patient procedure • 54
- output devices
  - custom output • 70
  - manage output groups • 50
  - output groups • 84
  - taskbar icons • 50
- output groups, manage • 84
- output groups, select • 69
- outputs, on-demand • 71

## P

- paddle shift • 47, 62
- paddle shift buttons • 27

## paddles

- compression • 97
- install • 99
- remove • 99
- shift • 27, 47, 62
- shift to new position • 62
- SmartCurve paddle • 94, 96

## patient

- close • 68
- delete • 57
- edit information • 54
- face shield • 92
- open • 54
- position • 109

## pending image, accept or reject • 79

- power button • 30
- Premium Acquisition Workstation • 30
- prerequisites for system use • 6
- preview image screen • 32, 75
- print • 73
- procedure screen • 60
- procedures
  - add • 65
  - close • 68

## Q

- quality control requirements • 7
- quality control tasks, perform • 49
- query worklist • 59

## R

- radiation safety • 14
- reject images • 77
- remove
  - compression paddles • 99
  - conventional face shield • 94
  - localization crosshair device • 104
  - magnification crosshair device • 105
  - Magnification Stand • 102
  - retractable face shield • 92
  - view • 66
- requirements
  - quality control • 7
  - skills needed • 6
  - training • 7

retractable face shield  
  install • 92  
  use • 93  
review  
  rejected image • 79  
ROI tab • 83

## S

safety  
  data loss • 14  
  equipment damage • 14  
  general information • 14  
  radiation • 14  
screening  
  acquire the image • 109  
screens  
  preview image • 75  
  query • 59  
scroll wheel • 30  
select  
  exposure parameters • 76  
  output groups • 69  
send images to outputs • 84  
Shifting Paddle system • 47, 62  
SmartCurve paddle • 94, 96  
specifications • 139  
  electrical • 145  
spot compression paddles • 97  
statement, cybersecurity • 8  
system  
  administration • 119  
  capabilities • 2  
  description • 11  
  messages • 154  
  power controls • 25  
  ready • 109  
  status icons • 50

## T

tabs  
  filter, column • 58  
taskbar • 50  
technical support • 8  
tools, image review • 81  
Touchscreen • 32

training requirements • 7  
tubehead, display • 27  
tubestand, controls and indicators • 26  
turn off system • 48  
turn on system • 33  
  preparation • 33

## U

uninterrupted power supply • 156  
user interface • 49  
user profiles • 6  
users menu • 50

## W

warnings, cautions and notes • 14  
  defined • 10  
window level • 81  
workflow, standard • 107  
worklist, query • 59

## X

x-ray  
  acquire image • 109  
  collimated fields • 38, 46  
  indicators • 109  
  switch (button) • 30



# HOLOGIC®



Hologic Inc.  
36 Apple Ridge Road  
Danbury, CT 06810 USA  
1 800 447 1856



Hologic Ltd.  
Heron House Oaks Business Park, Crewe Road  
Wythenshawe, Manchester. M23 9HZ, UK  
+44 (0)161 946 2206

Brazilian Contact: Imex Medical Group do Brasil  
Rua das Embaúbas, 601- Fazenda Santo Antônio  
São José /SC - Brasil - 88104-561  
+55 48 3251-8800  
[www.imexmedicalgroup.com.br](http://www.imexmedicalgroup.com.br)

CE  
0044