

# Horizon™



Horizon® Bone Densitometry System User Guide  
MAN-04871 Revision 012

**HOLOGIC®**



# **Horizon<sup>®</sup>**

## **Bone Densitometry System**

### **User Guide**

**Part Number: MAN-04871**  
Revision 012

January 2020

Caution: Federal (U.S.A.) law restricts this device to sale by or on the order of a physician (or properly licensed practitioner).

### **Customer Support**

Toll Free in USA: +1.800.321.4659

Email: [SkeletalHealth.Support@hologic.com](mailto:SkeletalHealth.Support@hologic.com)

In Europe, South America, or Asia, contact your local dealer or distributor.

© 2020 Hologic, Inc. Printed in the USA. This manual was originally written in English.

Hologic, Advanced Body Composition, APEX, Horizon, QDR, and associated logos are trademarks and/or registered trademarks of Hologic, Inc. and/or its subsidiaries in the U.S. and/or other countries. Any other product and company names mentioned herein are the trademarks of their respective owners.

This product may be protected by one or more U.S. or foreign patents as identified at [www.Hologic.com/patents](http://www.Hologic.com/patents).

---

# Table of Contents

<b>1 Overview .....</b>	<b>1</b>
1.1 Indications for Use .....	1
1.1.1 APEX Indications .....	1
1.1.2 IVA Indications .....	1
1.1.3 Body Composition Indications .....	1
1.1.4 Visceral Fat Software .....	2
1.1.5 10-year Fracture Risk Indications .....	2
1.1.6 Hip Structure Analysis Indications .....	3
1.1.7 Single Energy (SE) Femur Exam Indications .....	3
1.2 Contraindications .....	3
1.3 IEC Regulations .....	3
1.4 Warnings and Cautions .....	3
1.4.1 EMI .....	4
1.4.2 Accessories .....	4
1.4.3 Caution .....	4
1.5 Labels .....	4
1.6 Symbols .....	7
1.7 Support Materials .....	8
1.7.1 QDR Reference Manual .....	8
1.7.2 Online Help .....	8
1.7.3 QDR Series Technical Specifications Manual .....	8
1.7.4 QDR Cyber-Security Information .....	8
1.8 Main Window .....	8
1.8.1 Main Window Features .....	8
<b>2 System Startup and Shutdown.....</b>	<b>9</b>
2.1 System Startup .....	9
2.2 System Shutdown .....	9
<b>3 Quality Control Procedure .....</b>	<b>10</b>
3.1 System Test .....	10
3.2 Auto QC .....	10
3.3 Automatic Body Composition Calibration .....	11
<b>4 Patient Records .....</b>	<b>11</b>
4.1 Retrieving a Patient Record .....	11
4.2 Creating a Patient Record .....	11
4.3 Editing a Patient Record .....	12
4.4 Using Worklist to Retrieve a Patient Record .....	12

# Horizon Bone Densitometry System User Guide

## Table of Contents

---

4.5 Confirming Patient Information.....	12
4.5.1 Biographical Information.....	12
4.5.2 Exam Information.....	12
<b>5 Performing an Exam .....</b>	<b>13</b>
5.1 Patient Interview .....	13
5.2 Patient Preparation.....	13
5.3 Patient Selection.....	14
5.4 Choosing the Scan Type .....	14
5.5 Performing a Scan.....	14
<b>6 Manual Scan Analysis.....</b>	<b>14</b>
6.1 Analysis Step Buttons .....	14
6.2 Toolboxes.....	16
6.2.1 Bone Map Toolbox.....	16
6.2.2 Lines Toolbox (Spine).....	17
6.2.3 Neck Toolbox (Hip).....	17
6.2.4 Results Toolbox (Whole Body).....	17
6.2.5 Sub Region Toolbox.....	17
6.2.6 Toolbox Controls.....	18
6.3 Brightness/Contrast Control .....	19
<b>7 AP Lumbar Spine Examination.....</b>	<b>19</b>
7.1 Positioning the Patient.....	19
7.2 Positioning the C-arm .....	20
7.3 Starting the AP Lumbar Spine Scan.....	21
7.3.1 Repositioning the Scan (if necessary).....	21
7.4 Analyzing the Scan.....	22
7.4.1 One-Time™ Auto Analysis .....	23
7.5 Exiting Analysis.....	23
7.6 Generating and Printing Reports .....	23
<b>8 Hip Examination .....</b>	<b>24</b>
8.1 Positioning the Patient for Left, Right and Dual Hip Examinations.....	24
8.2 Positioning the C-arm .....	25
8.2.1 Tips to Identify the Greater Trochanter.....	25
8.2.2 Left Hip or Right Hip without Autopositioning for Hip Scans .....	26
8.2.3 Left Hip or Right Hip with Autopositioning for Hip Scans .....	26
8.2.4 Dual-Hip.....	27
8.3 Starting the Hip Scan .....	28
8.3.1 Repositioning the scan .....	28
8.3.2 Repositioning the patient.....	29

---

8.3.3 Additional Steps for the Dual-Hip Scan .....	29
8.4 Analyzing the Scan.....	29
8.4.1 One-Time Auto Analysis .....	29
8.5 SE (Single Energy) Femur Examination .....	30
8.5.1 Positioning for the SE Femur scan.....	31
8.5.2 Positioning for the SE Femur Scan after a Hip Scan .....	32
8.5.3 Starting the SE Femur Scan .....	32
8.5.4 Analysis of SE Femur Scan .....	32
8.5.5 Visual Assessment .....	33
8.5.6 Image Toolbox.....	33
8.5.7 Analysis Tools Control Tab .....	33
8.5.8 Assessment.....	34
8.6 References .....	36
8.6.1 Dual-Hip Scans.....	37
8.7 Generating and Printing Reports .....	37
<b>9 Forearm Examination .....</b>	<b>37</b>
9.1 Measuring the Patient's Forearm .....	37
9.2 Positioning the Patient.....	37
9.2.1 Positioning the Patient for Supine Forearm Examinations.....	39
9.3 Positioning the C-arm .....	41
9.4 Starting the Forearm Scan .....	41
9.4.1 Repositioning the Scan (if necessary).....	42
9.4.2 Repositioning the Patient (if necessary) .....	42
9.5 Analyzing the Scan.....	43
9.5.1 Entering the Forearm Length.....	43
9.5.2 Defining the Global ROI .....	43
9.5.3 Viewing the Bone Map.....	44
9.5.4 Checking the MID/UD Region.....	44
9.6 Viewing Results .....	45
9.7 Exiting Analysis.....	45
9.8 Generating and Printing Reports .....	45
<b>10 Whole Body Examination.....</b>	<b>46</b>
10.1 Body Composition Analysis .....	46
10.2 Positioning the Patient.....	46
10.3 Starting the Whole Body Scan .....	47
10.4 Whole Body Fan Beam Analysis .....	47
10.5 Analyzing the Scan.....	48
10.5.1 Body Composition Analysis.....	48

---

# Horizon Bone Densitometry System User Guide

## Table of Contents

---

10.5.2 Default Placement of Whole Body Regions .....	48
10.5.3 Adjusting A/G Regions (if necessary) .....	51
10.5.4 Visceral Adipose Tissue .....	52
10.5.5 Adjusting VAT Regions (if necessary) .....	53
10.5.6 VAT References .....	55
10.6 Viewing Results .....	56
10.6.1 Rulers .....	56
10.7 Exiting Analysis .....	57
10.8 User-Defined SubRegions .....	57
10.9 Resolving Asymmetric Results with Reflection .....	57
10.10 Enable NHANES BCA .....	59
10.11 Generating and Printing Reports .....	59
<b>11 Supine AP/Lateral Spine BMD Examination (Horizon A) .....</b>	<b>60</b>
11.1 Table Safety Feature .....	60
11.2 Positioning for the AP/Lateral Scan .....	60
11.3 Starting the AP Scan .....	61
11.4 Analyzing the AP Scan .....	61
11.5 Starting the Lateral Scan .....	61
11.6 Analyzing the Lateral Scan .....	62
11.6.1 Defining the Global ROI .....	62
11.6.2 Adjusting the Vertebral Boundaries .....	63
11.6.3 Adjusting the Vertebral Bodies .....	64
11.6.4 Viewing the Bone Map .....	64
11.6.5 Adjusting the Mid Regions .....	65
11.7 Viewing Results .....	65
11.8 Exiting Analysis .....	65
11.9 Generating and Printing Reports .....	65
<b>12 Decubitus Lateral Spine BMD Examination .....</b>	<b>66</b>
12.1 Performing and Analyzing the AP Scan .....	66
12.2 Positioning the Patient for the Decubitus Lateral Scan .....	66
12.3 Positioning the C-arm for the Decubitus Lateral Scan .....	67
12.4 Starting the Decubitus Lateral Scan .....	67
12.4.1 Repositioning the Scan (if necessary) .....	68
12.5 Analyzing the Scan .....	69
12.5.1 Defining the Global ROI .....	69
12.5.2 Adjusting the Vertebral Boundaries .....	69
12.5.3 Adjusting the Vertebral Bodies .....	70
12.5.4 Viewing the Bone Map .....	71



---

12.6 Viewing Results .....	71
12.7 Exiting Analysis .....	71
12.8 Generating and Printing Reports .....	71
<b>13 IVA, IVA HD Imaging on Horizon C, W; IVA Imaging on Horizon Ci, Wi .....</b>	<b>72</b>
13.1 Choosing the Scan Type .....	72
13.2 Positioning the Patient for the AP IVA Scan .....	72
13.3 Starting the AP IVA Scan .....	73
13.4 Positioning the Patient and C-arm for the Lateral IVA Scan .....	73
13.5 Starting the Lateral IVA Scan .....	74
13.6 IVA Analysis for Lateral IVA Scan .....	75
<b>14 IVA and IVA HD Imaging on a Horizon A System.....</b>	<b>75</b>
14.1 Positioning the Patient.....	75
14.2 Choosing the Scan Type .....	75
14.3 Starting the AP IVA Scan .....	76
14.4 Starting the Lateral IVA Scan .....	77
14.5 IVA Analysis for Lateral IVA Scan .....	77
<b>15 IVA with BMD Examination .....</b>	<b>78</b>
15.1 Positioning the Patient.....	78
15.2 Choosing the Scan Type .....	78
15.3 Perform the AP IVA Scan.....	78
15.4 Perform and Analyze the AP BMD Scan .....	79
15.5 Perform the Lateral BMD Scan.....	79
15.6 Perform the Lateral IVA Scan.....	79
15.7 IVA Analysis .....	79
<b>16 IVA Analysis.....</b>	<b>79</b>
16.1 Viewer Window, Left Panel.....	80
16.2 Viewer Window, Middle Panel .....	80
16.3 Viewer Window, Right Panel .....	80
16.4 Viewer Window, Left Panel, Visual Tools Tab .....	81
16.5 Viewer Window, Left Panel Analysis Tools Tab .....	81
16.6 Image Controls.....	83
16.7 DE Scan .....	84
<b>17 Interpreting the IVA Image .....</b>	<b>84</b>
<b>18 Markers .....</b>	<b>86</b>
18.1 Using Markers.....	87
18.1.1 Flipping the Image.....	87

---

# Horizon Bone Densitometry System User Guide

## Table of Contents

---

18.1.2 Adding Markers .....	87
18.1.3 Selecting Markers .....	87
18.2 Result Block .....	88
18.2.1 Result Block for Lateral IVA Scans .....	88
18.2.2 Result Block for AP IVA Scans .....	89
18.3 Printing .....	90
18.3.1 Print Report .....	90
18.3.2 Print Image .....	90
<b>19 Compare and Follow-up .....</b>	<b>91</b>
19.1 Restore a Baseline or Prior Scan .....	91
19.2 Evaluate the Baseline or Prior Scan .....	91
19.3 Perform the Follow-Up Scan .....	91
19.4 Analyze the Follow-up Scan Using Compare Analysis .....	91
19.5 Use the Legacy Image Style Option .....	92
19.6 Generate the Rate of Change Report .....	92
<b>20 Reports .....</b>	<b>92</b>
20.1 Report Information Blocks .....	93
20.2 Edit Comments .....	94
20.3 Rate of Change Report .....	94
20.3.1 Remove Asterisks (*) and Pound Signs (#) from Reports .....	94
20.3.2 Create Hip Pairs for Dual Hip Rate of Change Reports .....	95
20.4 Body Composition Reports .....	95
20.4.1 BCA Results .....	95
20.4.2 BCA Rate of Change Results .....	97
20.4.3 Body Composition Reports and Reference Database Comparisons .....	98
20.5 Pediatric Reports .....	99
20.6 DICOM Report .....	100
20.6.1 Enter the Accession Number and User Defined Entries .....	101
20.6.2 Preview a DICOM Report .....	101
20.6.3 Print a DICOM Report .....	101
20.6.4 Save a DICOM Report .....	101
20.6.5 Send a DICOM Report .....	101
20.6.6 Sort the Scan List .....	101
20.6.7 View the Queue .....	101
20.6.8 Close a DICOM Report .....	102
20.7 DxReport .....	102
20.7.1 Create a DxReport .....	102
<b>21 Interpreting Results .....</b>	<b>102</b>

---

21.0.1 About FRAX.....	104
21.0.2 FRAX Limiting Criteria .....	104
21.0.3 About 10-year Fracture Risk - All Countries .....	105
21.0.4 FRAX Risk Factors .....	106
21.0.5 References .....	107
<b>22 Archive Scans.....</b>	<b>107</b>
<b>23 Locate Scans .....</b>	<b>107</b>
<b>24 Restore Scans .....</b>	<b>107</b>
<b>25 Copy Scans .....</b>	<b>108</b>
<b>26 Query/Retrieve Scans .....</b>	<b>108</b>
<b>27 Perform System Backup.....</b>	<b>108</b>
<b>28 Clean the System.....</b>	<b>109</b>
28.1 Clean the QDR and Computer Components.....	109
28.2 Clean the Table Pad.....	109
28.3 Disinfect the Table Pad .....	109
28.4 Clean Accidental Spills .....	109
<b>29 Emergency Procedures .....</b>	<b>110</b>
29.1 Power Failure .....	110
29.1.1 Shutting Down .....	110
29.2 Failure During Operation.....	111
29.3 Loss of Power .....	111
<b>30 Dose Area Product Meter .....</b>	<b>111</b>
30.1 Turning the DAP Meter On and Off.....	111
<b>31 Utilities.....</b>	<b>112</b>
31.1 System Configuration .....	112
31.2 Usage .....	112
31.3 Database Tools .....	112
31.3.1 Patient Management.....	112
31.3.2 Export .....	112
31.3.3 Import .....	112
31.3.4 Reconcile.....	112
31.3.5 Patient Callback.....	112
31.3.6 Auto Baseline Utility .....	112
31.4 Scan File Look .....	113
31.5 Scan File Plot .....	113
31.6 Emergency Motion .....	113

# Horizon Bone Densitometry System User Guide

## Table of Contents

---

31.7 AP Reposition .....	113
31.8 Factory Utilities.....	113
31.9 Service Utilities .....	113
31.10 Reference Curve.....	113
31.10.1 Editor .....	113
31.10.2 Add Ethnicity .....	113
31.10.3 Restore .....	113
31.11 Rebuild Archive Index.....	113
31.12 Install Options.....	114
<b>32 Reference Curve .....</b>	<b>115</b>
32.1 Starting Reference Curve Editor.....	115
32.2 Viewing Reference Curve Data .....	115
32.3 Creating New Reference Curve Records .....	116
32.4 Copying a Reference Curve Record.....	118
32.5 Editing Reference Curve Records .....	119
32.6 Deleting Reference Curve Records .....	119
32.7 Adding New Ethnic Groups .....	120
32.8 Restoring Reference Curve Database .....	120
<b>33 DICOM Option .....</b>	<b>121</b>
<b>34 Configure DICOM Option.....</b>	<b>121</b>
34.1 DICOM Configuration Tabs .....	121
34.2 Modality Worklist .....	121
34.2.1 Configuring Modality Worklist .....	122
34.3 Query Parameters.....	122
34.4 Auto Query Interval.....	123
34.5 Query Retry Parameters .....	124
34.6 Purge Interval.....	125
34.7 Input From File .....	125
34.8 Worklist Provider .....	126
34.8.1 Worklist Provider Interface .....	126
34.8.2 Worklist Provider Controls .....	126
34.9 Map Worklist Fields.....	128
34.10 DICOM Send Destinations.....	129
34.10.1 Add / Edit DICOM Send Destination Dialog.....	131
34.10.2 Configure DICOM Send .....	133
34.11 DICOM Storage Commitment Destinations.....	133
34.11.1 Configure DICOM Send Destinations .....	134

---

34.11.2 Add / Edit Storage Commitment Destination Dialog.....	136
34.11.3 Configure Storage Commitment.....	136
34.12 DICOM Query/Retrieve Destinations .....	137
34.12.1 Add / Edit DICOM Query/Retrieve Destination Dialog .....	139
34.12.2 Configure Query/Retrieve .....	139
34.13 Host .....	140
<b>35 FRAX FAQs .....</b>	<b>141</b>

# Horizon Bone Densitometry System User Guide

## Table of Contents

---

# List of Figures

Figure 1: Horizon Main Window .....	7
Figure 2: Spine Phantom Position.....	9
Figure 3: AP Lumbar Spine Positioning .....	19
Figure 4: Leg Position.....	19
Figure 5: AP Lumbar Spine .....	20
Figure 6: Spine Repositioning .....	21
Figure 7: AP Lumbar Spine Analysis.....	22
Figure 8: Left Hip Positioning without Hip Autopositioning.....	23
Figure 9: Right Hip Positioning without Hip Autopositioning .....	24
Figure 10: Foot Positioning (Dual Hip).....	24
Figure 11: Left Hip Positioning with Hip Autopositioning.....	26
Figure 12: Hip Repositioning .....	27
Figure 13: Properly Analyzed Hip Scan .....	29
Figure 14: Left SE Femur Positioning.....	30
Figure 15: Measuring the Left Forearm .....	36
Figure 16: Left Forearm Positioning.....	37
Figure 17: Laser Position on Left Arm .....	37
Figure 18: Right Forearm Positioning .....	38
Figure 19: Laser Position on Right Arm .....	38
Figure 20: Patient On/Off Position for Left Supine Forearm .....	39
Figure 21: Patient Position for Left Supine Forearm.....	39
Figure 22: Patient Position for Right Supine Forearm .....	40
Figure 23: Forearm Repositioning .....	41
Figure 24: Forearm ROI.....	42
Figure 25: Forearm Bone Map .....	43
Figure 26: Forearm MID/UD .....	44
Figure 27: Whole Body Positioning.....	46
Figure 28: Whole Body Analysis (Horizontal and Lower Pelvic Divider Lines).....	48
Figure 29: Whole Body Analysis (Vertical Lines).....	49
Figure 30: A/G Regions .....	51

---

Figure 31: VAT Regions Pictured as CT Slice .....	52
Figure 32: Abdominal Tissue Features .....	53
Figure 33: VAT Regions .....	54
Figure 34: Asymmetric Results Warning.....	57
Figure 35: AP/Lateral Spine Positioning.....	60
Figure 36: Lateral Spine.....	61
Figure 37: Lateral ROI .....	62
Figure 38: Vertebral Boundaries .....	62
Figure 39: Vertebral Bodies.....	63
Figure 40: Lateral Bone Map .....	64
Figure 41: Decubitus Lateral Positioning .....	65
Figure 42: Spine Position .....	66
Figure 43: Decubitus Spine .....	67
Figure 44: Decubitus Repositioning .....	67
Figure 45: Lateral ROI .....	68
Figure 46: Vertebral Boundaries .....	69
Figure 47: Vertebral Bodies.....	69
Figure 48: Lateral Bone Map .....	70
Figure 49: AP IVA Positioning.....	72
Figure 50: Lateral IVA Positioning .....	73
Figure 51: Spine Position .....	73
Figure 52: AP IVA Positioning.....	74
Figure 53: Lateral IVA Positioning .....	76
Figure 54: IVA Viewer Window .....	78
Figure 55: The Human Spine.....	84
Figure 56: Vertebrae Deformities.....	85
Figure 57: Marker Placement.....	85
Figure 58: Adding a Marker .....	86
Figure 59: Selecting a Marker .....	87
Figure 60: Marker Data in the Result Block .....	87
Figure 61: Result Block .....	88
Figure 62: Report Blocks .....	92

---



# Horizon Bone Densitometry System User Guide

## List of Figures

---

Figure 63: Advanced Body Composition Report .....	94
Figure 64: Advanced Body Composition Rate of Change Report .....	95
Figure 65: Pediatric Spine Report .....	98
Figure 66: Create and Send a DICOM Report.....	98
Figure 67: Circuit Breaker and Indicator .....	108

# List of Tables

Table 1: Symbols .....	7
Table 2: Analysis Step Buttons .....	14
Table 3: Global ROI Toolbox .....	16
Table 4: Bone Map Toolbox .....	16
Table 5: Neck Toolbox (Hip) .....	17
Table 6: Neck Toolbox (Hip) .....	17
Table 7: Sub Region Toolbox .....	17
Table 8: Toolbox Controls .....	18
Table 9: Image Toolbox .....	33
Table 10: Assessment .....	34
Table 11: Adding and Modifying Rulers .....	34
Table 12: Display Options .....	35
Table 13: Change Annotations .....	35
Table 14: Atypical Femoral Fracture Assessment .....	36
Table 15: Ulnar Styloid Process .....	43
Table 16: Viewer Window, Left Panel .....	80
Table 17: Viewer Window, Middle Panel .....	80
Table 18: Viewer Window, Right Panel .....	80
Table 19: Viewer Window, Left Panel, Visual Tools Tab .....	81
Table 20: Assessment Area .....	81
Table 21: Display Options Area .....	82
Table 22: Change Annotations Area .....	82
Table 23: Image Controls .....	83
Table 24: Result Block Labels .....	89
Table 25: Result Block for the AP IVA Scan .....	90
Table 26: Follow-up Scan Procedures .....	91
Table 27: Advanced Body Composition Report Fields .....	96
Table 28: Advanced Body Composition Graph Fields .....	96
Table 29: Advanced Body Composition Rate of Change Report Fields .....	97
Table 30: Advanced Body Composition Rate of Change Graph Fields .....	98

---

Table 31: FRAX Risk Factors .....	106
Table 32: Reference Curve Description Fields .....	117
Table 33: Query Parameters .....	123
Table 34: Auto Query Interval .....	124
Table 35: Query Retry Parameters .....	124
Table 36: Purge Interval .....	125
Table 37: Input From File .....	126
Table 38: Worklist Provider Features .....	126
Table 39: Worklist Provider .....	127
Table 40: Performed Procedure Step .....	127
Table 41: Provider .....	127
Table 42: DICOM Send Destinations .....	129
Table 43: DICOM Send Destinations .....	131
Table 44: DICOM Send Configuration .....	133
Table 45: DICOM Storage Commitment Destinations .....	134
Table 46: Storage Commitment Destination Editing .....	136
Table 47: Storage Commitment Configuration .....	136
Table 48: DICOM Query/Retrieve Destinations .....	137
Table 49: Add / Edit DICOM Query/Retrieve Destination .....	139
Table 50: Query/Retrieve Configuration .....	139
Table 51: Host Configuration .....	140

# Horizon Bone Densitometry System User Guide

## List of Tables

---

# 1 Overview

## 1.1 Indications for Use

### 1.1.1 APEX Indications

The APEX™ for QDR™ X-ray Bone Densitometers is indicated for the estimation of bone mineral density (BMD), comparison of measured variables obtained from a given QDR scan to a database of reference values, the estimation of fracture risk, vertebral deformity assessment, body composition analysis, and discrimination of bone from prosthetics using the Hologic QDR X-ray Bone Densitometers.

### 1.1.2 IVA Indications

IVA scans are intended for the visualization or quantitative assessment of vertebral bone deformities. IVA also allows the visualization of abdominal aortic calcification, and, if present, clinical correlation may be advised since abdominal aortic calcification may be associated with cardiovascular disease.

### 1.1.3 Body Composition Indications

The Hologic Whole Body DXA Reference Database software used on Hologic QDR bone densitometers measures the:

- regional and whole body bone mineral density,
- lean and fat tissue mass, and
- calculates derivative values of:
  - bone mineral content
  - area
  - soft tissue mass
  - regional soft tissue mass
  - total soft tissue mass
  - fat free mass
  - regional and total soft tissue mass ratios
  - % fat, regional
  - % fat, total body
  - % fat, android
  - % fat, gynoid
  - % fat, android/gynoid ratio
  - body mass index

The values can be displayed in user-defined statistical formats and trends with color image mapping, and compared to reference populations at the sole discretion of the health care professional.

These body composition values are useful to health care professionals in their management of diseases and conditions where the disease and conditions itself, or its treatment, can affect the relative amounts of fat and lean tissue. The Hologic Whole Body DXA Reference Database software does not diagnose disease, recommend treatment regimens, or quantify treatment effectiveness. Only the health care professional can make these judgments. Some of the diseases (and conditions) for which body composition values are useful include chronic renal failure, anorexia nervosa, obesity, AIDS/HIV, and cystic fibrosis. DXA body composition is a useful alternative to hydrostatic weighting and skin fold measurements.

### 1.1.4 Visceral Fat Software

The Hologic Visceral Fat Software used on Hologic Horizon® bone densitometer total body scans estimates the visceral adipose tissue (visceral fat) content within the android region in an adult male or female population, excluding pregnant women. The content that is estimated is the Visceral Fat Area, Visceral Fat Mass, and Visceral Fat Volume. These values can be displayed in user-defined statistical formats and trends.

The estimated visceral fat content is useful to health care professionals in their management of diseases/conditions where the disease/conditions itself, or its treatment, can affect the relative amounts of visceral fat content in the android region.



**Note**      *The Hologic Visceral Fat Software does not diagnose disease, recommend treatment regimens, or quantify treatment effectiveness. Only the health care professional can make these judgments.*

Some of the diseases/conditions for which visceral fat estimation is useful include hypertension, impaired fasting glucose, impaired glucose tolerance, diabetes mellitus, dyslipidemia, and metabolic syndrome.

### 1.1.5 10-year Fracture Risk Indications

Femoral neck BMD and clinical risk factors are used to estimate 10-year risk of hip fracture and 10-year risk of major osteoporotic fracture using the World Health Organization (WHO) algorithm (FRAX®) in adults. The physician may use the 10-year fracture risk, along with the physician's knowledge of patient history, and apply medical expertise and best practice clinical judgment to determine if therapeutic intervention is indicated.

### 1.1.6 Hip Structure Analysis Indications

The Hip Structure Analysis (HSA<sup>®</sup>) for QDR X-ray Bone Densitometers uses data from conventional Dual Energy X-ray Absorptiometry (DXA) scans to measure the distribution of bone mineral mass at specific cross sections of the hip and allows the physician to estimate structural properties of the hip, such as CSA, CSMI, Z and Buckling Ratio.

### 1.1.7 Single Energy (SE) Femur Exam Indications

Single Energy (SE) femur exams are used to visualize focal reaction or thickening along the lateral cortex of the femoral shaft, which may be accompanied by a transverse radiolucent line. Clinical correlation is advised as these features may be consistent with atypical femur fractures, a complication associated with long term use of antiresorptive therapy.

## 1.2 Contraindications

Pregnancy and the use of contrast agents within the past 7 days are contraindicated. See [Section 5.1 Patient Interview](#) on Page 13 for more information.

## 1.3 IEC Regulations

QDR Series X-ray Bone Densitometers comply with the requirements of IEC 60601-1. The classification of the QDR Series X-ray Bone Densitometers under this specification is Class 1, Type B.

The QDR Series comply with IEC 60601-1-3 except for Section 29.205.2 which specifies “...focal spot to skin distances (FSSDs) of 45 cm or more in normal use.” The QDR Series FSSD, which is approximately 42.5 cm, has been selected to provide optimum spatial resolution and precision with minimum patient exposure.

The QDR Series comply with the following IEC standards:

IEC 60601-1	2014	IEC 60601-2-28	2010
IEC 60601-1-2	2014	IEC 60825-1	2014
IEC 60601-1-3	2013	IEC 60601-1-6	2013

Software used in the QDR Series was developed using IEC 62304 as a guide.

## 1.4 Warnings and Cautions



**Warning:** *To avoid risk of electric shock, this equipment must only be connected to a supply mains with protective earth.  
No modification of this equipment is allowed.*

# Horizon Bone Densitometry System User Guide

## 1. Overview

### 1.4.1 EMI

This instrument is designed to be compatible with the electromagnetic environments specified in IEC60601-1-2 and will operate satisfactorily when placed in an environment that includes other equipment complying with that standard.

### 1.4.2 Accessories

Do not use any accessories in conjunction with this instrument other than those supplied by Hologic for use with the instrument.

### 1.4.3 Caution



#### Caution

*To protect the integrity of the system and the safety of the patient and operator, do not power the computer and accessories plugged into the outlet strip at the rear of the console from another source. Also, do not power any accessories or appliances other than those provided with the system from the outlet strip at the rear of the console.*

## 1.5 Labels

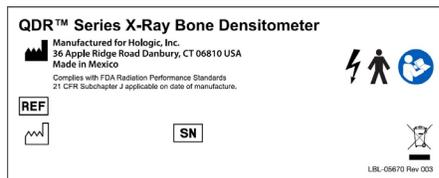

### Horizon System Main Label

The **Main Label** includes:

- QDR X-ray Bone Densitometer
- Horizon Model
- Manufacturer name and address
- Complies with FDA Radiation Performance Standards 21 CFR Subchapter J applicable on date of manufacture.
- Date of manufacture
- Serial Number
- IEC standards

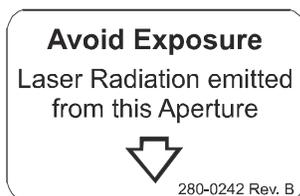

### Laser Exit Aperture Label

The **Laser Exit Aperture Label** includes:

- Avoid Exposure
- Laser Radiation emitted from this Aperture





### INMETRO & ULBR Product Label

The INMETRO & ULBR Product Label includes:

- includes the INMETRO & ULBR symbols
- Segurança

AC POWER			
Line Voltage (V)	100	120	230
Frequency (Hz)	50/60	50/60	50/60
Maximum Current (A)	16	14	8
Maximum Apparent Resistance (ohm)	0.32	0.32	1.28

280-6379 Rev 004

### AC Power Label

The AC Power Label lists system power specifications including:

- Line Voltage (V)
- Frequency (Hz)
- Maximum Current (A)
- Maximum Apparent Resistance (ohm)

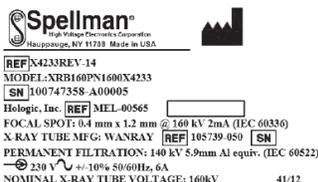

### Tank Label

The Tank Label includes:

- Manufacturer name and address
- Model numbers
- Serial Numbers
- Nominal tube rating
- Focal spot
- Filtration Aluminum equivalence

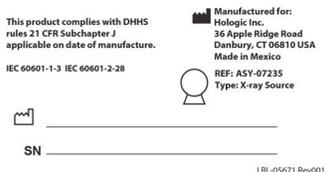

### HF X-ray Source Label

The HF X-ray Source Label includes:

- 21 CFR Compliance statement
- Date of manufacture
- Model number of the source assembly
- Type: Assembly, source
- Serial Number of the source assembly
- IEC standards

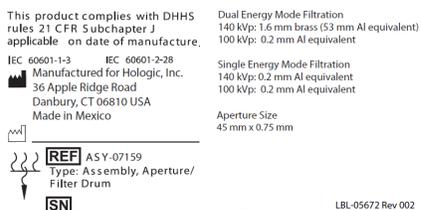

### Drum Filtration Label

The Drum Filtration Label includes:

- 21 CFR Compliance statement
- Manufacturer name and address
- Model assembly number
- Serial number
- EC and IEC numbers

# Horizon Bone Densitometry System User Guide

## 1. Overview

---

THIS PRODUCT COMPLIES WITH DHHS RULES 21 CFR  
SUBCHAPTER J APPLICABLE ON DATE OF MANUFACTURE

 HOLOGIC, INC.  
36 Apple Ridge Road Danbury, CT 06810 USA

COMPUTER ASSEMBLY

REF \_\_\_\_\_

SN \_\_\_\_\_



LBL-05668 Rev.002

System Computer

REF \_\_\_\_\_



 Hologic, Inc.  
36 Apple Ridge Road  
Danbury, CT 06810 USA

Electrical Rating: 120/230 VAC, 60/50 Hz 7/4A  
LBL-05669 Rev.002



**WARNING:** This x-ray unit may be dangerous to patient and operator unless safe exposure factors, operating instructions and maintenance schedules are observed.  
280-0266 Rev.002

### Computer Certification Label

The **Computer Certification Label** includes:

- 21 CFR Compliance statement
- Manufacturer name and address
- Computer assembly number
- Computer assembly serial number
- Manufacture date
- 

### System Computer Label

The **System Computer Label** includes:

- System Computer assembly number
- Manufacture date
- Manufacturer name and address
- Electrical rating
- 

### X-ray Warning Label

- **Warning:** This x-ray unit may be dangerous to patient and operator unless safe exposure factors, operating instructions and maintenance schedules are observed.

## 1.6 Symbols

Table 1 Symbols

	CSA listed device		CE mark
	Dangerous voltage		Caution
	X-ray source assembly		X-ray source emitting
	Warning: Electricity		Alternating current
	Type B applied part		Protective earth (ground)
	Date of Manufacture		Manufacturer
	Equipment to be disposed in compliance with European Directive 2002/96/EC on Waste Electrical and Electronic Equipment.		Authorized representatives in the European Community
	Catalog number		Serial number
	Radiation filter		INMETRO & ULBR Mark
	Follow instructions for use		Danger: Pinch Point
	Temperature Limit		Humidity Limit

### 1.7 Support Materials

#### 1.7.1 QDR Reference Manual

Reference for system technology information.

#### 1.7.2 Online Help

Click Help in the main window or on most dialogs, or press **F1**.

#### 1.7.3 QDR Series Technical Specifications Manual

Reference for specification information.

#### 1.7.4 QDR Cyber-Security Information

Log on for support information. For QDR cyber-security information access: <https://www.hologic.com/package-inserts/breast-skeletal-health-products/horizon-dxa-system-package-insertsifus>

### 1.8 Main Window

Figure 1 Horizon Main Window



#### 1.8.1 Main Window Features

**1-Menu Bar**

**2-Main Work Area**

**3-Patient and Scan Records**

**4-System Functions**

5-System Messages

6-Daily Functions

7-Help

## 2 System Startup and Shutdown

### 2.1 System Startup

1. Verify the Control Panel up and locked in horizontal position (on Horizon A Models only).



**Note**

*On Horizon A models, when the table is in the Patient On/Off position, the Control Panel swings down vertically to facilitate patient transfer from a stretcher to the Horizon table.*

*When the Control Panel is in the vertical down position, the system automatically shuts down table communication with the application as a normal safety function. When the Control Panel is returned to the horizontal position, after a three-second delay, table communication is restored for normal operation.*

2. On the **Control Panel**, verify the **E-stop** button is up.
3. Turn the computer on.  
The monitor and printer should already be on during a normal system startup.
4. Log on to the **QDR**.

### 2.2 System Shutdown

1. Click **Exit** in the main window.
2. Select **Exit QDR with shutdown?**
3. Click **OK**.



**Caution**

*Do not turn off the circuit breaker.  
Do not turn off the monitor or printer.*

## 3 Quality Control Procedure

1. Click **Daily QC** in the main window.
2. Place the spine phantom on the table with the registration mark ([Figure 2A](#)) to the left, foot end.
3. Position the phantom parallel to the back of the table.
4. Align the laser cross hair ([Figure 2B](#)) with the registration mark.
5. Click **Continue**.

Figure 2 Spine Phantom Position

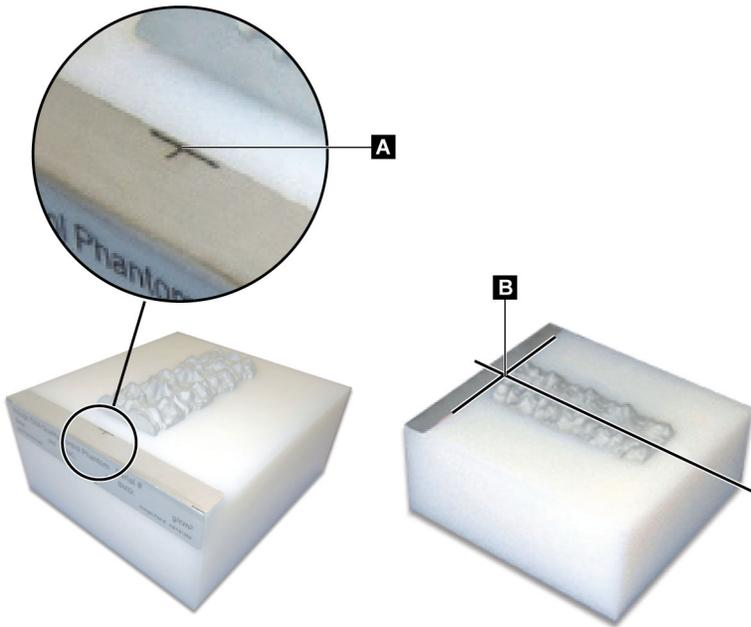

### 3.1 System Test

If the system test fails, follow the instructions on screen to resolve the problem, and repeat QC.

### 3.2 Auto QC

When Auto QC passes, click **OK** to start scanning patients.

If Auto QC fails, follow the instructions to resolve the problem.

### 3.3 Automatic Body Composition Calibration

QDR systems with **APEX or QDR for Windows XP Version 12.4.2 and higher** (except upgraded systems), incorporate an automatic calibration for Body Composition. The system monitors when the calibration was last performed and, if a week has elapsed, automatically performs the calibration when QC is run. This process adds only a few seconds to the QC procedure.

When the calibration is complete, the system prompts you to remove the QC phantom.

1. Click **OK** to perform the Radiographic Uniformity test for Adult WB.  
If Infant WB is installed, it will run immediately after the Adult WB test.
2. When this test is complete, click **OK** to return to the main screen.

## 4 Patient Records

If the patient is a woman under the T-score reporting age, and postmenopausal, the menopause age must be entered in the biography or a T-score will not be generated.



**Note**      *The T-score reporting age is configurable (age 50 is the default).*

### 4.1 Retrieving a Patient Record

1. Click **Patients** in the main window.
2. Click the **patient's name** to select.



**Note**      *To use search criteria, click the heading and type the search criterion into the text box.*

### 4.2 Creating a Patient Record

1. Click **Patients** in the main window.
2. Click **New Patient**.
3. Click the **Biography** tab.
  - a. Enter the patient information.
  - b. Click **OK**.
4. Click the **Insurance** tab.
  - a. Enter the patient information.
  - b. Click **OK**.

### 4.3 Editing a Patient Record

1. Click **Patients** in the main window.
2. Click **Edit Patient**.
3. Click the **Biography** tab and change information as needed.
4. Click the **Insurance** tab and change information as needed.
5. Click **OK**.

### 4.4 Using Worklist to Retrieve a Patient Record



**Note**      *Worklist is an option on QDR systems.*

1. Click **Perform Exam** in the main window.
2. Click the **Worklist** tab.
3. Click **Query**.
4. Highlight the desired patient's name.
5. Click **OK**.
6. Confirm the patient information
  - a. Click **OK** or
  - b. Click **Edit Patient** to edit the patient record, as described above.

### 4.5 Confirming Patient Information

The Patient Confirmation window is used to confirm, or enter, exam related information, FRAX<sup>®</sup> limiting criteria and FRAX risk factors.

#### 4.5.1 Biographical Information

Ensure the patient name, ID, birth date, current weight and current height are correct.

#### 4.5.2 Exam Information

Confirm or edit the exam information as necessary.

1. Enter or change patient information.
2. Answer Questionnaire data.
3. Complete all assessment data.

Exam information includes:

- operator
- *accession number* that uniquely identifies a patient visit,
- referring physician
- user defined fields



## 5 Performing an Exam

### 5.1 Patient Interview

The following is a list of questions to ask the patient (some may not apply).

**Is there any chance of pregnancy?**

If a female patient is (or may be) pregnant, postpone the scan until pregnancy is ruled out.

**Has the patient had any radiological procedure using the following contrast agents within the last 7 days:**

- Iodine
- Barium

Radiological contrast agents used for X-ray and CT can interfere with DXA scans. In particular, oral contrasts can remain in the gastrointestinal tract for several days affecting DXA results. Intravenous iodine normally clears within 72 hours for those patients with normal kidney function.

Hologic DXA measurements have been shown in several studies to be unaffected by nuclear isotope studies, so DXA measurements can be done immediately after nuclear isotope studies as long as the studies do not also include radiological contrast agents (such as iodine and barium).

**Is the patient wearing any objects in the scan area such as an ostomy device, metal buttons or snaps, or jewelry?**

This may interfere in the scanning of the patient.

**Has the patient had any surgery in the area being scanned?**

If so, consider whether to perform the examination. For example, any of the following internal objects could interfere with the scan:

- Pacemaker leads
- Radioactive seeds
- Metal implants
- Surgical staples
- Foreign bodies; e.g., shrapnel
- Radio-opaque catheters or tubes

If the patient had surgery on a hip or forearm, then the uninjured hip or forearm should be scanned.

### 5.2 Patient Preparation

To prepare the patient for the examination:

- Ensure that there is no metal (e.g., zipper, snap, belt, etc.) in the scan field. If necessary, have the patient change into a gown for the examination.
- For AP lumbar spine, hip, or whole body examinations, instruct the patient to remove their shoes.
- The subject weight limit is 227 kg (500 lbs.). For patients over this limit, scan the forearm.

### 5.3 Patient Selection

1. Click **Perform Exam** in the main window.
2. Create or retrieve a patient record.
3. Click **OK**.
4. Confirm the patient information.
5. Click **OK**.

### 5.4 Choosing the Scan Type

1. From the **Select Scan Type** window, select the type of exam to be performed.
2. Click **Next >>**.

### 5.5 Performing a Scan

For instructions on how to perform a specific scan type refer to the appropriate section of this manual.

## 6 Manual Scan Analysis

To analyze a scan use the analysis step buttons, toolbox and brightness/contrast control found at the left side of the analysis window.

### 6.1 Analysis Step Buttons

Each of the analysis step buttons is used to perform one step of the analysis. To analyze a scan, click each button in order, starting at the top button, and perform the operation required until all steps are completed.

**Table 2 Analysis Step Buttons**

Button	Function
<b>Global ROI (Region of Interest)</b>	The defined boundaries of the image that is being analyzed. The ROI appears on the image as a box.

**Table 2 Analysis Step Buttons (Continued)**

Button	Function
<b>Bone Map</b>	An illustration, created by the system, of the area of bone defined by the ROI. The map is superimposed, in yellow, on the image.
<b>Vertebral Lines (Spine)</b>	Used to mark the intervertebral spaces within the spine region of interest.
<b>Neck (Hip)</b>	Allows positioning of the hip femoral neck box. The neck box should not include the ischium.
<b>MID/UD (Forearm)</b>	Allows positioning of the middle (MID) and ultra-distal (UD) regions of the forearm.
<b>Regions (Whole Body)</b>	Used to define regions of interest on a whole body scan.
<b>A/G Regions (Whole Body)</b>	Used to delineate the Android and Gynoid regions on the Whole Body image. For Body Composition results the A/G Regions are used to calculate fat and lean (includes BMC) content and percent fat of the Android and Gynoid regions of the body.
<b>VAT Regions</b>	On APEX 4.0 and above the A/G Regions analysis step button also displays VAT Regions. VAT Regions are used to delineate the Visceral Adipose Tissue (VAT) regions on the Whole Body image. The VAT regions include the skin on the edge of the abdominal region and the visceral cavity.
<b>Sub Regions (Whole Body)</b>	Used to delineate one or more areas within the Whole Body scan. There can be up to seven SubRegions and they can have irregular shapes and overlap. For Body Composition results, the fat and lean (includes BMC) content, and percent fat, of each SubRegion is calculated along with the net average (NETAVE) for all SubRegions.
 <b>Note</b>	<i>If SubRegions overlap then the net average will be the mathematical union of the individual regions.</i>
<b>Sub Regions Results (Whole Body)</b>	Displays results of the SubRegion analysis on the analysis window. For Body Composition results, click BCA.
<b>Vertebral Boundaries (Lateral Spine BMD)</b>	Used to identify the anterior boundary of the vertebral bodies, as a dashed yellow line, on a lateral spine image.
<b>Vertebral Bodies (Lateral Spine BMD)</b>	Used to identify the boundaries of the vertebral bodies, as boxes, on a lateral spine image.

**Table 2 Analysis Step Buttons (Continued)**

Button	Function
<b>Mid Regions (Lateral Spine BMD)</b>	Used to adjust the regions in the middle of the vertebral bodies on a lateral spine image (rarely necessary).
<b>Results</b>	Displays results of the analysis on the analysis window.

## 6.2 Toolboxes

Toolboxes provide the tools used at each step of the analysis. The tools that are available depend upon scan type being analyzed and the step button in use.

**Table 3 Global ROI Toolbox**

Tool	Function
<b>Whole Mode</b>	Allows the entire ROI box to be moved over the image. The box is shown as dashed yellow lines.
<b>Line Mode</b>	Allows one line on the ROI box to be moved. Click any line to select it. The active line is shown as yellow dashes.
<b>Point Mode</b>	Allows one point on the ROI box to be moved. Points are shown on the box as plus signs. The active point is yellow.
<b>1/3 Distal (Forearm only)</b>	Used to adjust the size of the 1/3 distal region of the forearm (rarely necessary).

### 6.2.1 Bone Map Toolbox

**Table 4 Bone Map Toolbox**

Tool	Function
<b>Add Bone</b>	Used to connect outside edges on an incomplete bone map and fill in the missing area (rarely necessary).
<b>Delete Bone</b>	Used to erase an area on the bone map (rarely necessary).
<b>Undo</b>	Negates the last action performed.
 <b>Note</b>	<i>Undo</i> allows the operator to view the unprocessed bone map. Viewing the bone map before islands are sunk and holes in the bone are filled by the analysis algorithm can reveal how well the automatic bone-finding algorithm worked and can be used with problematic scans. The <i>Undo</i> feature is active and available for all non-whole body scan types in the <b>Bone Map</b> stage.

### 6.2.2 Lines Toolbox (Spine)

Used to mark the intervertebral spaces within the spine region of interest.

### 6.2.3 Neck Toolbox (Hip)

**Table 5 Neck Toolbox (Hip)**

Tool	Function
Neck Box	Allows the neck box to be moved and/or resized (rarely necessary). The box is shown as dashed yellow lines.
Other Regions	Expands the Neck Toolbox to include Midline, Ward's Triangle and Trochanter tools.
Midline	Allows the midline to be moved or pivoted (rarely necessary).
Ward's Triangle	Allows Ward's Triangle to be adjusted (rarely necessary).
Trochanter	Allows the Trochanter area to be adjusted (rarely necessary).
Auto Position	Allows the system to automatically locate a region.

### 6.2.4 Results Toolbox (Whole Body)

**Table 6 Neck Toolbox (Hip)**

Tool	Function
BMD	Display BMD results in the analysis window.
BCA	Display BCA results in the analysis window.
Rulers	Allows measurement of the patient's anatomy by placing rulers on the scan image. Rulers are displayed in the analysis window, on the image, when Display is checked.

### 6.2.5 Sub Region Toolbox

**Table 7 Sub Region Toolbox**

Tool	Function
One Region	Manipulate SubRegions individually.
All Regions	Manipulate all SubRegions together as a unit.
Undo	Negate the last action performed.

## Horizon Bone Densitometry System User Guide

### 6. Manual Scan Analysis

#### 6.2.6 Toolbox Controls

Table 8 Toolbox Controls

Control	Function
	Cursor used to move a SubRegion(s).
	Cursor used to rotate a SubRegion(s). The hand is open until rotation is started; during rotation the hand is shown with pinched thumb and first finger.
	Used in lumbar spine analysis (Vertebral Lines) to select the line above the currently selected line.
	Used in lumbar spine analysis (Vertebral Lines) to select the line below the currently selected line.
	Increases the size of the cursor used to add or delete bone from a bone map.
	Decreases the size of the cursor used to add or delete bone from a bone map.
	Used to create a SubRegion.
	Used to delete a SubRegion.
	Used to select the next SubRegion in a sequence of two or more SubRegions.
	Used to select the previous SubRegion in a sequence.
	Used to flip a SubRegion(s) vertically.
	Used to flip a SubRegion(s) horizontally.
	Used to move counterclockwise to select the next line or point in a SubRegion.

Table 8 Toolbox Controls (Continued)

Control	Function
	Used to move clockwise to select the next line or point in a SubRegion.

## 6.3 Brightness/Contrast Control

	Used to adjust brightness and contrast of the image to obtain best definition of anatomical features. Does not affect calculations.
---	---

# 7 AP Lumbar Spine Examination

Start the exam as described in [Section 4.4 Using Worklist to Retrieve a Patient Record](#) on Page 12. In the **Select Scan Type** window, select **AP Lumbar Spine**.

## 7.1 Positioning the Patient

1. On the Control Panel, press **Patient On/Off**.
2. Place the patients on their back with their head at the right end of the table.
3. On the Control Panel, press **Center**.

4. Position the patient as shown (Figure 3 and Figure 4).

**Figure 3 AP Lumbar Spine Positioning**

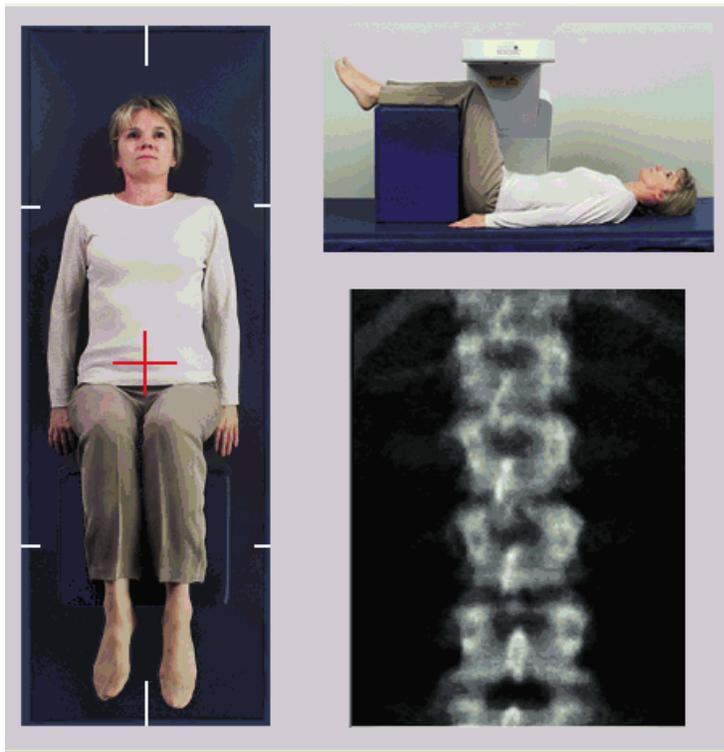

### 7.2 Positioning the C-arm

1. On the Control Panel, press **Laser**.
2. Use the **Arm** and Table controls to place the laser's cross hair 2.5 to 5 cm (1 to 2 inches) below the iliac crest and centered at the patient's mid-line.
3. Instruct the patient to remain still and breathe normally.

**Figure 4 Leg Position**

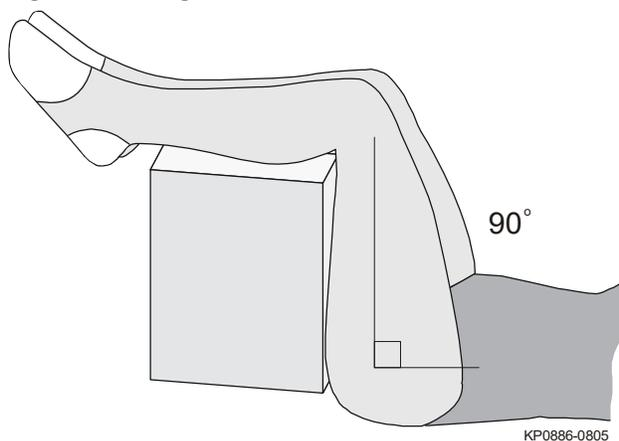



## 7.3 Starting the AP Lumbar Spine Scan



**Warning:** *If the Control Panel X-ray indicator fails to shut off within 10 seconds after the end of the scan, press the red **Emergency Stop** button immediately. Call your Hologic service representative before resuming operation.*

1. Click **Start Scan**. The X-rays *On* indicator flashes until the scan stops.
2. Inspect the image as it is generated.
  - If the spine is positioned correctly, when you see the ribs attached to T12 on the image ([Figure 5](#)), click **Stop Scan**.
  - If the spine is not positioned correctly, click **Reposition Scan** to stop the scan for repositioning.

**Figure 5** AP Lumbar Spine

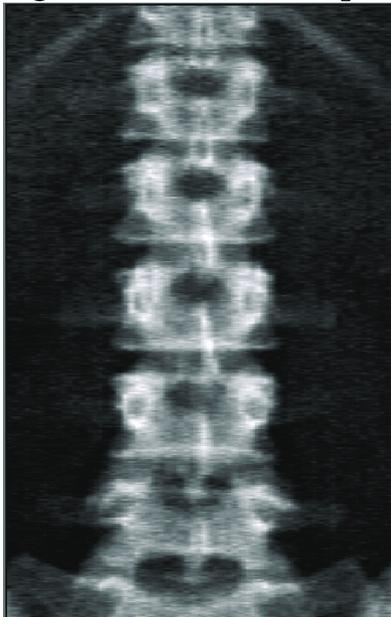

### 7.3.1 Repositioning the Scan (if necessary)

1. Click **Reposition Scan** before the scan is completed.
2. Position the cursor over the spine image ([Figure 6](#)).

**Figure 6 Spine Repositioning**

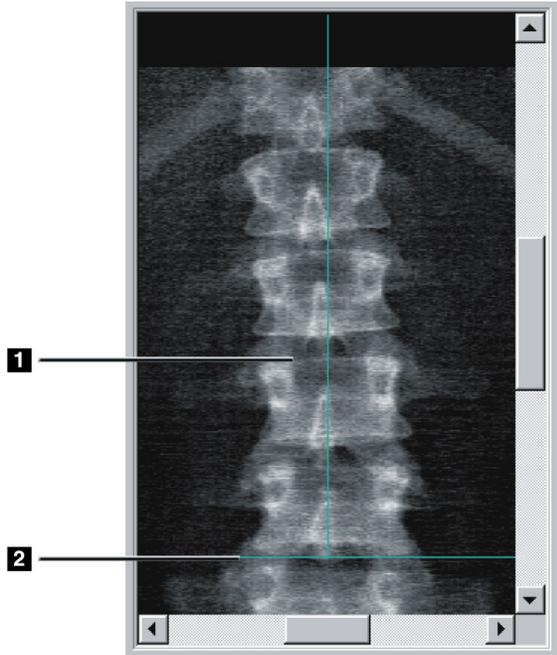

3. To reposition the spine, click and drag the image so that:
  - The center of the lumbar spine is aligned with the blue vertical positioning line [1].
  - The iliac crest is at or below the blue horizontal positioning line [2].



**Note** *You can also use the scroll bars to reposition the image.*

4. When the spine is positioned correctly, click **Restart Scan**.
5. Click **Start Scan**.
6. When you see the ribs attached to **T12** on the image, click **Stop Scan**.

## 7.4 Analyzing the Scan

1. Click **Analyze Scan**.
2. If there is a prior scan, click **Results**.

If there is no prior scan, click **Next >>**. A histogram appears to the right of the image in a window during all the analysis steps. It is intended to aide in the placement of intervertebral lines.

Click the >> button at the upper right, to expand and << button to contract the window.

You can configure the histogram from the *DXApro* configuration screen. Refer to Configuring the System in the *MAN-03648 Horizon Reference Manual*.

### 7.4.1 One-Time™ Auto Analysis

When auto-analysis is complete, results are displayed.



**Note** *If Auto-Analysis is unsatisfactory, perform a manual analysis (Figure 7) for correct analysis.*

**Figure 7 AP Lumbar Spine Analysis**

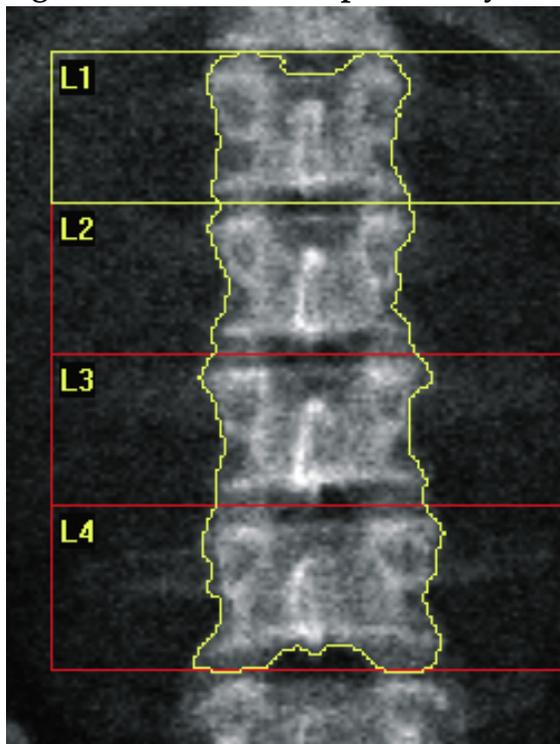

### 7.5 Exiting Analysis

1. Click **Close**.
2. Click **Report**.

### 7.6 Generating and Printing Reports

See [Section 20 Reports](#) on Page 92.

## 8 Hip Examination

1. Start the exam as described in [Section 4.4 Using Worklist to Retrieve a Patient Record](#) on Page 12.
2. In the Select **Scan Type** window, select **Left Hip**, **Right Hip** or **Dual-Hip**.

### 8.1 Positioning the Patient for Left, Right and Dual Hip Examinations

1. Position the patient as shown ([Figure 8](#) and [Figure 9](#)).  
Use the foot positioner supplied by Hologic to maintain the correct femur position.

**Figure 8 Left Hip Positioning without Hip Autopositioning**



2. On the Control Panel press **Center**.
3. Place the foot positioner under the patient's legs
4. Align its center with the table and the patient's midline.
5. Rotate the entire leg (on the side to be scanned) 25° inward.
6. Place the medial edge of the foot against the positioner.  
The foot should be flexed toward the ceiling ([Figure 8](#) and [Figure 9](#)).
7. Adjust the strap to hold the foot in the correct position.

For Dual Hip scans rotate both legs 25° inward and adjust both straps to hold feet in correct position (Figure 10).

**Figure 9 Right Hip Positioning without Hip Autopositioning**



**Figure 10 Foot Positioning (Dual Hip)**

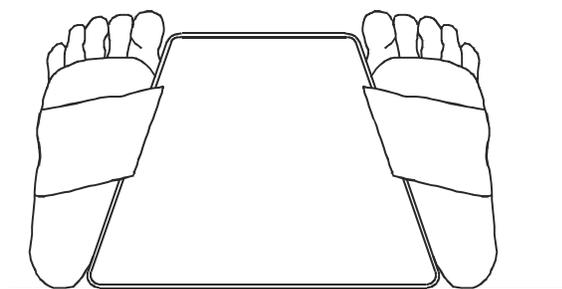

## 8.2 Positioning the C-arm



**Note**

*On hip scans of overweight or obese subjects: Abdominal fat overlying the hip region should be held back or otherwise retracted from the X-ray field of view because overlying fat (panniculus) may interfere with hip BMD results.*

### 8.2.1 Tips to Identify the Greater Trochanter

1. Place your thumb on the iliac crest.

2. *Spread your fingers.*
3. *Direct your little finger toward the knee.*

*The greater trochanter is located under your little finger.*

*If you are not able to feel the trochanter:*

1. *Have the patient bend the leg at the knee and lift.*
2. *Locate the crease formed at the top of the leg.*

*Use this as an approximate location of the greater trochanter.*

#### 8.2.2 Left Hip or Right Hip without Autopositioning for Hip Scans

1. On the **Control Panel** press **Laser**.
2. Use the **Arm** and **Table** controls on the Control Panel to place the laser's cross hair:
  - 7.6 cm (3 inches) below the greater trochanter
  - 2.5 cm (1 inch) medial to the shaft of the femur.

Refer to:

[Figure 8](#) for left hip, or [Figure 9](#) for the right hip.

[Section 8.2.1 Tips to Identify the Greater Trochanter](#) on Page 25.

3. Instruct the patient to remain still and breathe normally.

#### 8.2.3 Left Hip or Right Hip with Autopositioning for Hip Scans

1. Enable **Autopositioning** for Hip Scans.
2. From the **APEX Main Menu** select:
  - Utilities
  - System Configuration
  - Check Autopositioning for Hip Scans.
3. On the **Control Panel** press **Laser**.
4. Use the **Arm** and **Table** controls on the **Control Panel** to place the laser's cross hair at the outer edge of the greater trochanter ([Figure 11](#) for left hip).

See [Section 8.2.1 Tips to Identify the Greater Trochanter](#) on Page 25.

5. Instruct the patient to remain still and breathe normally.

**Figure 11 Left Hip Positioning with Hip Autopositioning**

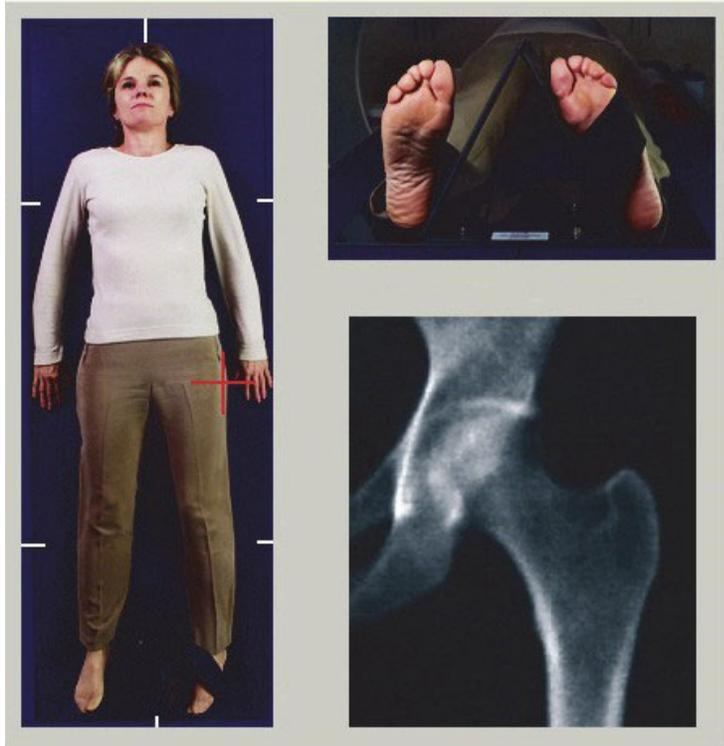

### 8.2.4 Dual-Hip

1. Turn on the laser and position the C-arm over the patient's midline.
2. Click **Continue**.
3. Palpate the patient's left leg to identify the greater trochanter.  
See [Section 8.2.1 Tips to Identify the Greater Trochanter](#) on Page 25.



**Note** *For Dual-Hip, the left hip is always scanned first.*

4. Use the **Arm** and **Table** controls to place the laser's cross hair 7.6 cm (3 inches) below the greater trochanter and 2.5 cm (1 inch) medial to the shaft of the femur.



**Note** *If using Autopositioning, place the laser's cross hair at the outer edge of the greater trochanter.*

5. Click **Continue**.
6. Instruct the patient to remain still and breathe normally.

### 8.3 Starting the Hip Scan



**Warning:** *If the Control Panel X-ray indicator fails to shut off within 10 seconds after the end of the scan, press the red Emergency Stop button immediately. Call your Hologic service representative before resuming operation.*

1. Click **Start Scan**. The X-rays On indicator flashes until the scan stops.
  - a. Verify that the hip scan is acceptable as the image generates.
  - b. If the hip is not positioned correctly, click **Reposition Scan** to stop the scan for repositioning.

To reposition the image to include the entire femoral head ([Section 8.3.1 Repositioning the scan](#) on Page 28). If the shaft is not parallel, see [Section 8.3.2 Repositioning the patient](#) on Page 29.

#### 8.3.1 Repositioning the scan

1. Click **Reposition Scan** before the scan is completed.
2. Position the cursor over the hip image.



**Note** *You can also use the scroll bars to reposition the image.*

**Figure 12 Hip Repositioning**

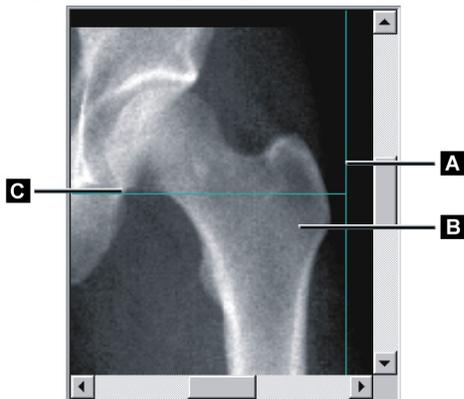

3. To position the hip, click and drag the image to the intersection of the two blue positioning lines, so the:
  - vertical positioning line **[A]** touches the outer edge of the Greater Trochanter **[B]**
  - horizontal positioning line **[C]** is centered on the Greater Trochanter **[B]**
4. Click **Restart Scan**.
5. Click **Start Scan**.



### 8.3.2 Repositioning the patient

1. Click **Reposition Scan** before the scan is completed.
2. Click **Restart Scan**.
3. Click **Start Scan**.
4. Evaluate the image as it displays. If the image is satisfactory, allow the scan to complete.

### 8.3.3 Additional Steps for the Dual-Hip Scan

In a Dual-Hip scan, the scanner moves to the right hip after finishing the scan of the left hip. If **SE Femur** is enabled, the system will prompt you to perform a SE Femur scan of the left femur prior to moving to the right hip. It will also prompt you to perform a SE Femur of the right femur after finishing the scan of the right hip. See [Section 8.5.2 Positioning for the SE Femur Scan after a Hip Scan](#) on Page 32 and [Section 8.5.3 Starting the SE Femur Scan](#) on Page 32.

1. Turn the laser on.
2. Check that the laser is positioned properly over the patient's right hip.
3. Click **Continue**.
4. Verify that the right hip scan is acceptable.
5. If it is not, reposition the image or patient and rescan.

## 8.4 Analyzing the Scan

1. Click **Analyze Scan**.
2. If there is a prior scan, click **Results**.

If there is no prior scan, click **Next >>**.

### 8.4.1 One-Time Auto Analysis

When auto-analysis is complete, results are displayed.



**Note** *If Auto-Analysis is unsatisfactory, perform a manual analysis. For correct analysis, see [Figure 13](#).*

**Figure 13 Properly Analyzed Hip Scan**

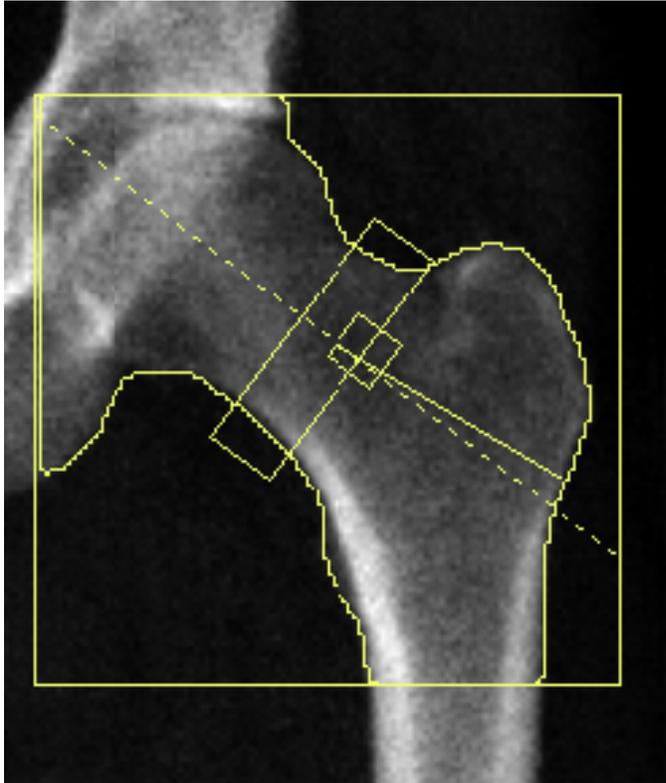

### 8.5 SE (Single Energy) Femur Examination

Start the exam as described in [Section 4.4 Using Worklist to Retrieve a Patient Record](#) on Page 12. SE Femur scans can be selected directly from the **Select scan type** window or they can be selected at the end of a BMD hip scan. Selecting a SE Femur scan at the end of a hip scan is only possible if SE Femur scans are configured via a check-box on the **System Configuration** screen.

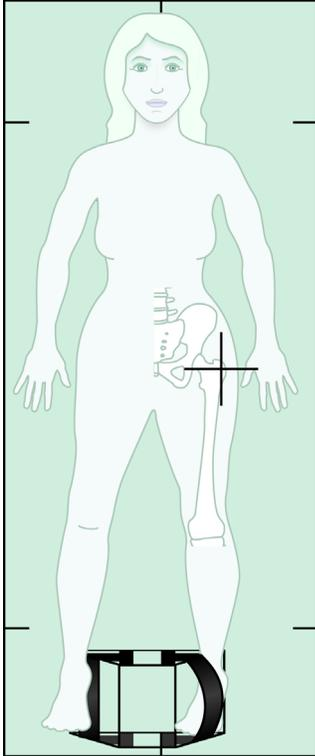
**Figure 14 Left SE Femur Positioning**

### 8.5.1 Positioning for the SE Femur scan

1. Position the patient as shown in [Figure 14](#).

Use the foot positioner supplied by Hologic to maintain the correct femur position.

2. On the **Control Panel** press **Center**.
3. Place the foot positioner under the patient's legs, and
4. Align it center with the table and the patient's midline.
5. Rotate the entire leg (on the side to be scanned) 25° inward and place the medial edge of the foot against the positioner.

The foot should be flexed toward the ceiling.

6. Adjust the strap to hold the foot in the correct position.
7. In the **Select Scan Type** window choose SE Femur.
8. Palpate the patient's leg to identify the greater trochanter. See [Section 8.2.1 Tips to Identify the Greater Trochanter](#) on Page 25.
9. On the Control Panel, press Laser.
10. Use the Arm and Table controls on the Control Panel to place the laser's cross hair:
  - Level of the greater trochanter

- Middle of the shaft of the femur or slightly off set outward toward the outer edge of the femur to accommodate the entire length of the femur.

11. Instruct the patient to remain still and breathe normally.

### 8.5.2 Positioning for the SE Femur Scan after a Hip Scan

1. After performing a single hip scan, you may choose to perform an SE Femur scan.
2. Click on the button labeled **SE Femur Scan**.

The **Positioning Femur Scan** Screen appears which shows you where the system will automatically position the C-arm. The screen provides the operator with the ability to reposition the scan image before the femur scan.

3. Verify that the image will start at the level of the greater trochanter and that the shaft of the femur is centered or slightly off set toward the inner edge of the femur to accommodate the entire length of the femur.
4. Click **Next**.

### 8.5.3 Starting the SE Femur Scan



**Warning:** *If the Control Panel X-ray indicator fails to shut off within 10 seconds after the end of the scan, press the red Emergency Stop button immediately. Call your Hologic service representative before resuming operation.*

1. Click **Start Scan**. The X-rays On indicator flashes until the scan stops.
2. Verify that the SE femur scan is acceptable as the image generates. If the image is satisfactory, allow the scan to complete.
3. If the SE Femur scan is not positioned correctly, click **Reposition Scan** to stop the scan for repositioning.

### 8.5.4 Analysis of SE Femur Scan

The image appears in the viewer window.

The Viewer allows the operator to view the SE Femur image. The controls on the Viewer allow the operator to:

- change viewing modes
- zoom
- adjust the brightness and contrast of the image
- add annotations
- add comments
- place Rulers.

### 8.5.5 Visual Assessment

1. Visually inspect the image for deformity<sup>1 2 3</sup> particularly along the lateral cortex from the lesser trochanter to the supracondylar flare.
2. Look for focal reaction or thickening along the lateral cortex, which may be accompanied by a transverse radiolucent line.
3. Use the visual tools to increase magnification and adjust the contrast.

The changes in the lateral cortex may be subtle.



**Note**      *The images should be read by a qualified medical professional.*

### 8.5.6 Image Toolbox

**Table 9**      **Image Toolbox**

Tool	Function
<b>Multi View</b>	When selected, places the viewer in Multiple View mode, displaying a second image in the right hand panel.
<b>Visual Tools and Analysis Tools will operate independently on either image. If both images are the same, analysis performed on the center image will be reflected on the image in the right panel.</b>	
<b>W-L Control</b>	Click and drag the <i>ball</i> in the center of the triangle to adjust the contrast and brightness of the image. For finer adjustment: <ol style="list-style-type: none"> <li>1. Right click on the image.</li> <li>2. Click <b>Adjust WL</b>.</li> <li>3. Click and drag the cursor on the image.</li> </ol>
<b>Invert</b>	Inverts the grayscale value of each pixel creating a negative of the image.
<b>Zoom</b>	Is used to shrink or enlarge the scan image.

### 8.5.7 Analysis Tools Control Tab

The Analysis Tools control tab provides tools to assess any deformities seen in the image. The tools in this section provide tools to:

- Control the method of adding Annotations and/or Rulers
- Control display of Annotations and Rulers on image
- Change Annotations

### 8.5.8 Assessment

Two radio buttons that determine which tool will be used when a user clicks in the image.

**Table 10 Assessment**

Tool	Function
<b>Annotations</b>	When selected and you left-click on the image an annotation window will appear allowing for text to be entered and saved. Up to two annotations can be created.
<b>Rulers</b>	When selected and you left-click and drag on the image a ruler will be created. Rulers is a tool that allows the operator to measure cortical thickness and/or other features by placing rulers on the scan image. Up to six rulers may be added.

**Table 11 Adding and Modifying Rulers**

Tool	Function
<b>Add Ruler</b>	<p>The cursor changes to a cross when placed over the scan image.</p> <ol style="list-style-type: none"> <li>1. Place the cross on the image where the ruler will start.</li> <li>2. Click and drag a line to place the ruler. The length of the new ruler (in centimeters) is displayed below the Rulers button.</li> <li>3. To add rulers repeat the above.</li> </ol>
<b>Select Ruler</b>	<p>The cursor changes to a hand when placed directly on a ruler. With the hand cursor displayed, click to select a ruler.</p>
<b>Move Ruler</b>	<ol style="list-style-type: none"> <li>1. Select the ruler.</li> <li>2. With the hand cursor displayed, click and drag the ruler to the desired location, or</li> <li>3. Use the keyboard arrow keys to move the ruler up, down, left or right.</li> </ol>
<b>Select Endpoint of Ruler</b>	<p>The cursor changes to an arrow at the endpoint of a ruler. With the arrow cursor displayed, click to select the endpoint.</p>

**Table 11 Adding and Modifying Rulers**

<b>Tool</b>	<b>Function</b>
<b>Change the Size of Ruler</b>	With the arrow cursor displayed, <ol style="list-style-type: none"> <li>1. Click and drag the endpoint to the desired length and location, or</li> <li>2. Use the keyboard arrow keys to move the endpoint up, down, left or right.</li> </ol>
<b>Delete a Ruler</b>	<ol style="list-style-type: none"> <li>1. Select the ruler and click the keyboard <b>Delete</b> key, or,</li> <li>2. With the hand cursor displayed, right-click and select <b>Delete</b>.</li> </ol>

### Display Options

Two check boxes that specifies what assessments that are displayed on the image.

**Table 12 Display Options**

<b>Tool</b>	<b>Function</b>
<b>Annotations</b>	When checked, locations of any annotations that have been created on the image will be displayed. They are identified as 1 and 2.
<b>Rulers</b>	When checked, any rulers that have been created on the image will be displayed.

### Change Annotations

Three buttons that provides the user with a means to add/change annotations. These buttons are enabled when an Annotation window is displayed on the image.

**Table 13 Change Annotations**

<b>Tool</b>	<b>Function</b>
<b>Focal Thickening</b>	Clicking on this button will display the annotation edit window and populate the edit field with the following text: "Focal reaction or thickening along the lateral cortex of the femoral shaft is present."
<b>Radiolucent Line</b>	Clicking on this button will display the annotation edit window and populate the edit field with the following text: "A transverse radiolucent line is present."
<b>Free Text</b>	Clicking on this button will display the annotation edit window where free text can be entered.

### Atypical Femoral Fracture Assessment

The text for all of the annotations and lengths of all rulers placed on the image will be displayed in this section. There is also a comment section where free text can be entered as well as two buttons with predefined text that when clicked will populate in the Comments box.

**Table 14 Atypical Femoral Fracture Assessment**

Tool	Function
<b>Correlation Advised</b>	Clicking on this button will insert the following text into the comment section: "Clinical correlation is advised as these features may be consistent with an incomplete atypical femur fracture."
<b>Drug Complication</b>	Clicking on this button will insert the following text into the comment section: "Atypical femur fractures are a complication associated with long term use of antiresorptive therapy."

## 8.6 References

These references include further information about atypical femur fractures and the accompanying radiographic appearance and risk factors:

1. Elizabeth Shane, David Burr, Peter R Ebeling, Bo Abrahamsen, Robert A Adler, et al. "Atypical Subtrochanteric and Diaphyseal Femoral Fractures: Report of a Task Force of the American Society for Bone and Mineral Research." *Journal of Bone and Mineral Research*, Vol. 25, No. 11, November 2010
2. Elizabeth Shane (Co-Chair)\*, David Burr, Bo Abrahamsen, Robert A. Adler, Thomas D. Brown, Angela M. Cheung, Felicia Cosman, Jeffrey R. Curtis, Richard Dell, David W. Dempster, Peter R. Ebeling, Thomas A. Einhorn, Harry K. Genant, Piet Geusens, Klaus Klaushofer, Joseph M. Lane, Fergus McKiernan, Ross McKinney, Alvin Ng, Jeri Nieves, Regis O'Keefe, Socrates Papapoulos, Tet Sen Howe, Marjolein C.H. van der Meulen, Robert S. Weinstein, Michael P. Whyte. Atypical subtrochanteric and diaphyseal femoral fractures: Second report of a task force of the American society for bone and mineral research *J Bone Miner Res*. DOI: 10.1002/jbmr.1998
3. Zehava Sadka Rosenberg, Renata La Rocca Vieira, Sarah S. Chan, James Babb, Yakup Akyol, et al. "Bisphosphonate-Related Complete Atypical Subtrochanteric Femoral Fractures: Diagnostic Utility of Radiography." *AJR*:197, October 2011



4. FDA Drug Safety Communication: Safety update for osteoporosis drugs, bisphosphonates, and atypical fractures; <http://www.fda.gov/Drugs/DrugSafety/ucm229009.htm>

### 8.6.1 Dual-Hip Scans

1. After analysis of the right hip, click **Close**.
2. To analyze the left hip, click **Analyze Another Scan**.

## 8.7 Generating and Printing Reports

See [Section 20 Reports](#) on Page 92.

# 9 Forearm Examination

1. Start the exam as described in [Section 4.4 Using Worklist to Retrieve a Patient Record](#) on Page 12.
2. In the **Select Scan Type** window, select **Left Forearm** or **Right Forearm**.

## 9.1 Measuring the Patient's Forearm

1. Measure the forearm up to the ulna styloid [1] in centimeters. ([Figure 15](#)).
2. Record the measurement.

**Figure 15 Measuring the Left Forearm**

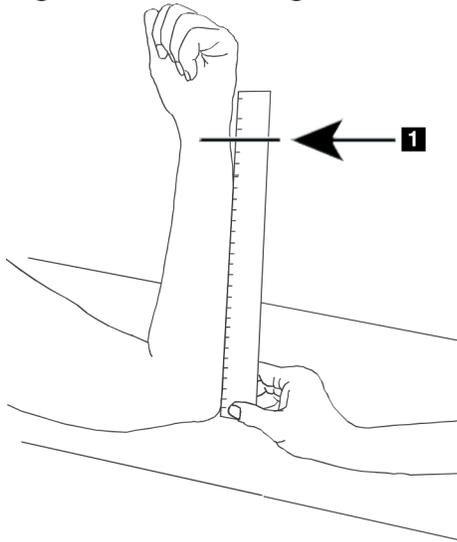

## 9.2 Positioning the Patient

1. On the Control Panel press **Center**.
2. Position the patient as shown in:

- [Figure 16](#) for left forearm.
- [Figure 18](#) for right forearm.
- [Figure 20](#) and [Figure 21](#) for left supine forearm.
- [Figure 22](#) for right supine forearm.

**Figure 16 Left Forearm Positioning**



**Figure 17 Laser Position on Left Arm**

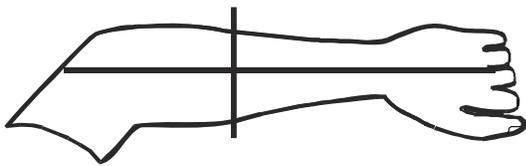

**Figure 18 Right Forearm Positioning**



**Figure 19 Laser Position on Right Arm**

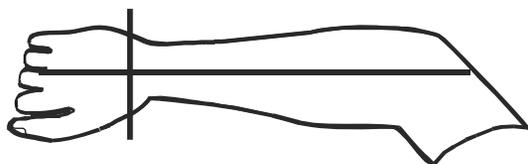

### 9.2.1 Positioning the Patient for Supine Forearm Examinations

1. Position the patient hip at the outer edge of the table.
2. For right forearm, place the patient's left arm across the chest. For left forearm, place the patient's right arm across the chest.
3. Bend the elbow so that the forearm is parallel to the long side of the table.
4. Align the long bones of the forearm with the long axis of the laser.
5. Ensure that no obstruction is within 1 cm (.5 inch) of the radius and ulna sides of the forearm.

**Figure 20 Patient On/Off Position for Left Supine Forearm**

Move C-Arm to far right

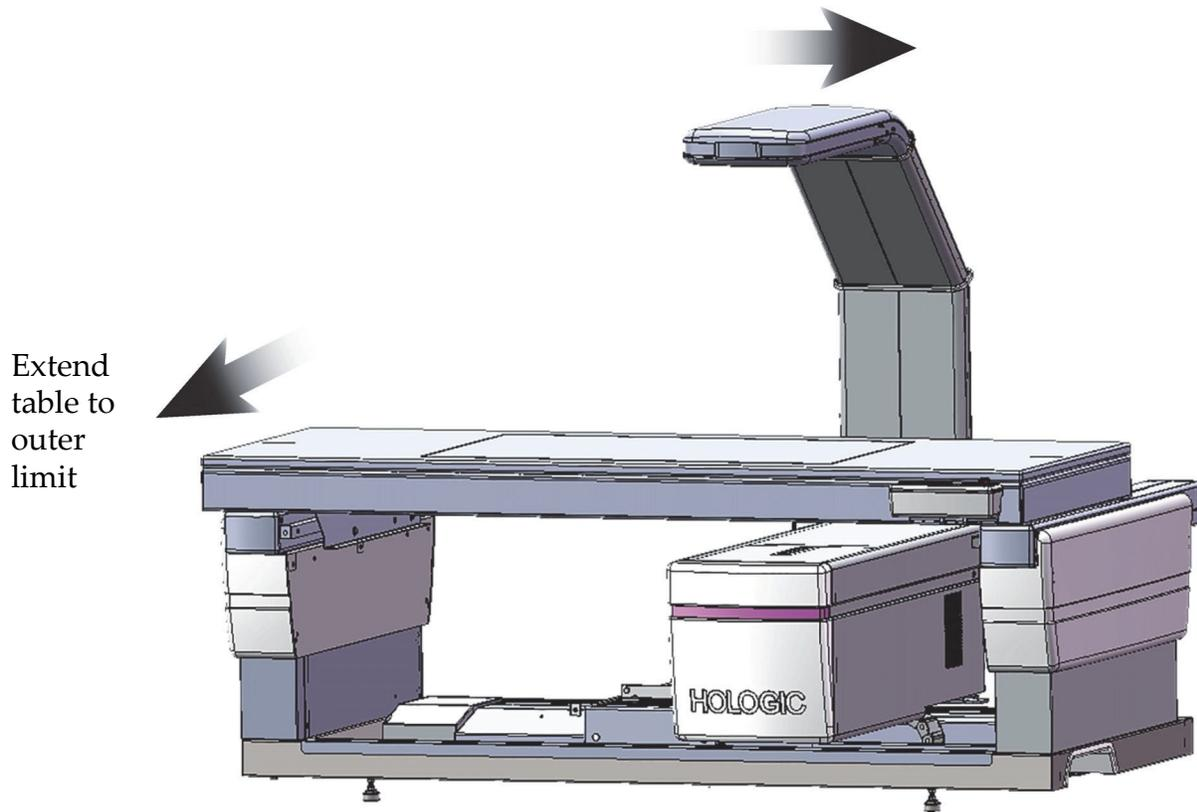

**Figure 21 Patient Position for Left Supine Forearm**

Allow no obstruction within 1 cm (.5 inch) on each side of the arm

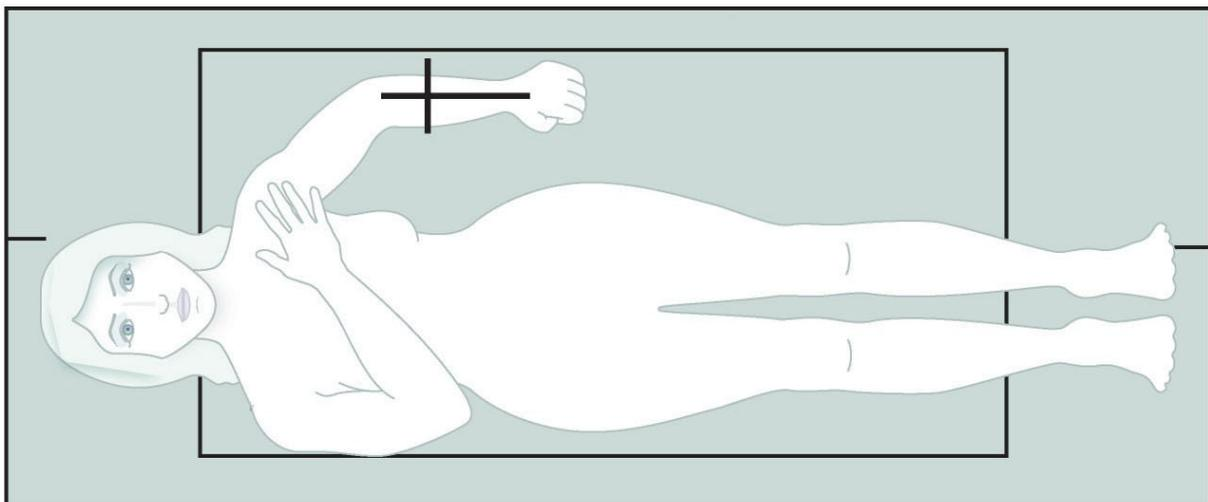
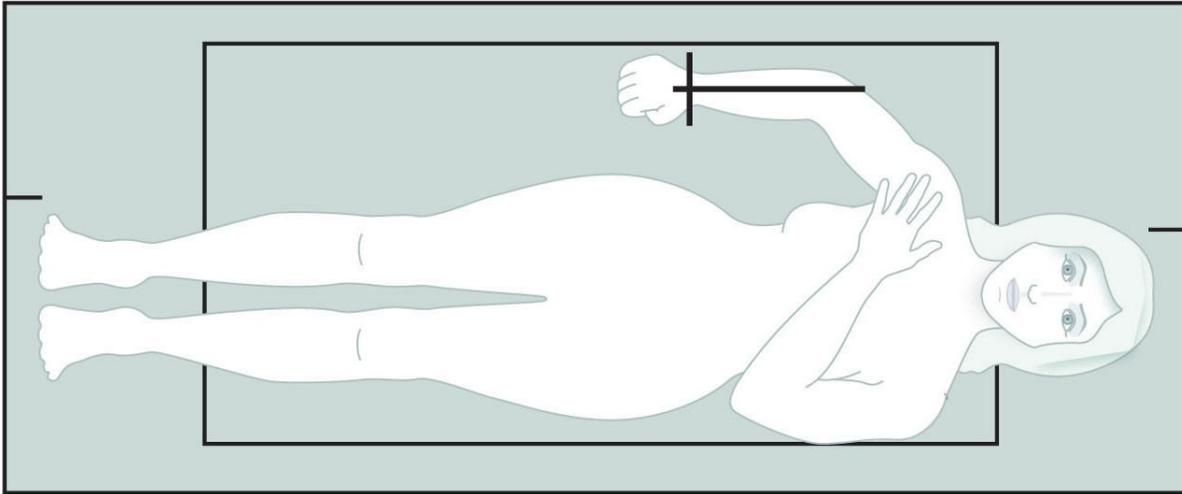

Figure 22 Patient Position for Right Supine Forearm



### 9.3 Positioning the C-arm

1. On the Control Panel, press **Laser**.
2. Use the **Arm Controls** on the Control Panel to position the starting point on the forearm:
  - **Left Forearm Scan:** Starts at the mid-forearm. Verify that the first row of carpal bones are within 15 cm (6 inches) of the starting point (Figure 17).
  - **Right Forearm Scan:** Starts at the first row of carpal bones (Figure 19).
3. Instruct the patient to remain still and breathe normally.

### 9.4 Starting the Forearm Scan



**Warning:** *If the Control Panel X-ray indicator fails to shut off within 10 seconds after the end of the scan, press the red Emergency Stop button immediately. Call your Hologic service representative before resuming operation.*

1. Click **Start Scan**. The X-rays *On indicator* flashes until the scan stops.
2. Inspect the image.
  - The radius and ulna must appear straight and centered.
  - The image shows at least the first row of carpal bones near the bottom for a right forearm scan, or near the top for a left forearm scan.
  - The ulna side contains at least enough air to equal the ulna's shaft width.
3. If the image is not acceptable, click **Reposition Scan**.

4. If the image is acceptable, allow the scanning to complete.

### 9.4.1 Repositioning the Scan (if necessary)

1. Click **Reposition Scan** before the scan is completed.
2. Position the cursor over the forearm image.



**Note**      *You can use the scroll bars to reposition the image.*

**Figure 23 Forearm Repositioning**



3. To position the forearm:
  - Move the first row of carpal bones within the horizontal blue positioning line and the outer limit of the scan field.
  - The radius and the ulna should be parallel between the two blue vertical positioning lines.
4. When the forearm is positioned correctly, click **Restart Scan**.
5. Click **Start Scan**.

### 9.4.2 Repositioning the Patient (if necessary)

1. Adjust the forearm so that it is straight.



**Note**      *The patient's forearm should be moved to include or exclude more of the carpal bones.*

2. Click **Restart Scan**.
3. Click **Start Scan**.

- Evaluate the image as it displays. If the image is satisfactory, allow the scan to complete.

## 9.5 Analyzing the Scan

- Click **Analyze Scan**.



**Note** For descriptions of Analysis Step Buttons and Toolboxes, see [Section 6.1 Analysis Step Buttons](#) on Page 14.

- Click **Next >>**.

### 9.5.1 Entering the Forearm Length

- Click **Length**. The forearm length must be between 4.0 and 42.0 centimeters.
- Enter the length in centimeters.

### 9.5.2 Defining the Global ROI

- Click **Global ROI**.
- Using the **Whole Mode** and **Line Mode** tools, adjust the ROI as shown in [Figure 24](#).

**Figure 24 Forearm ROI**

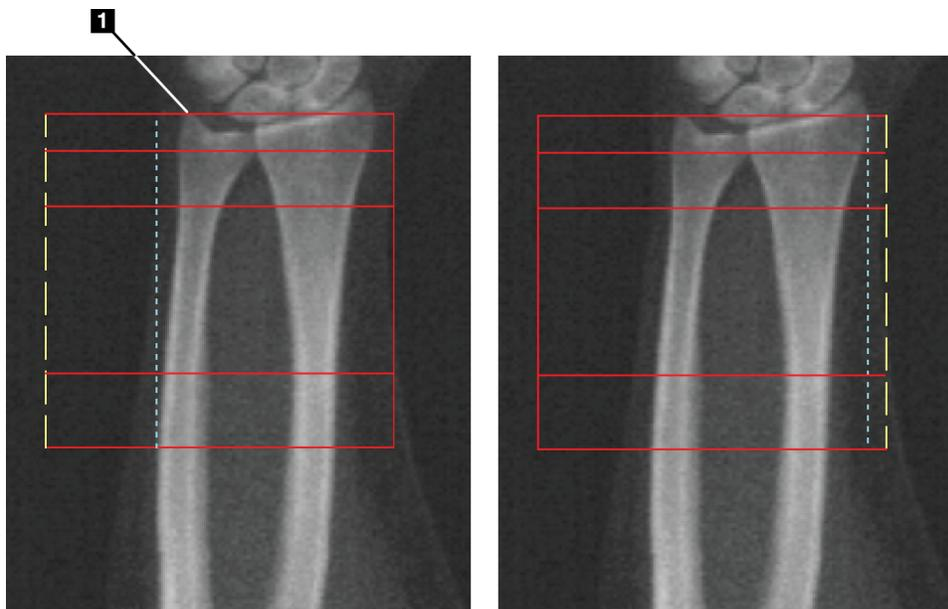

**Table 15 Ulnar Styloid Process**

Item	Description
1	Ulnar Styloid Process



### Note

*Using Whole Mode, the top line of the Global ROI box should be placed at the tip of the Ulnar styloid.*

*Using Line Mode, move the ROI line on the radius side in until the blue dashed line is just touching the lateral edge of the radius.*

*Repeat this process on the ulna side, making sure approximately 1 – 2 cm of air is included in the Global ROI on the ulna side.*

*In subjects with large forearms, the dashed blue line may have to be moved outward from the lateral edge of the ulna to include the required 1 – 2 cm of air background points.*

### 9.5.3 Viewing the Bone Map

1. Click **Bone Map**.
2. In most cases it will not be necessary to edit the bone map. If it is required, use the toolbox tools to edit the bone map as shown in [Figure 25](#).

**Figure 25 Forearm Bone Map**

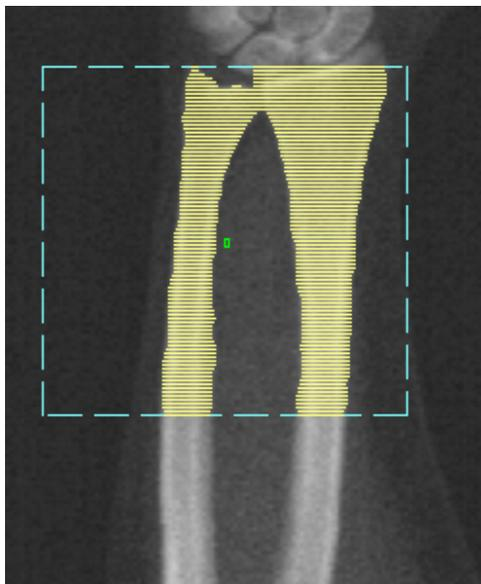

### Note

*The Global ROI must contain adequate air points to ensure proper bone mapping and analysis results. In some subjects, the blue dashed line on the ulna side may need to be adjusted outward to include adequate air points.*

### 9.5.4 Checking the MID/UD Region

1. Click **MID/UD**.

In most cases it will not be necessary to adjust the MID/UD region or reposition the ulna/radius divider.



2. If it is required, use the toolbox tools to adjust as shown in [Figure 26](#).

**Figure 26 Forearm MID/UD**

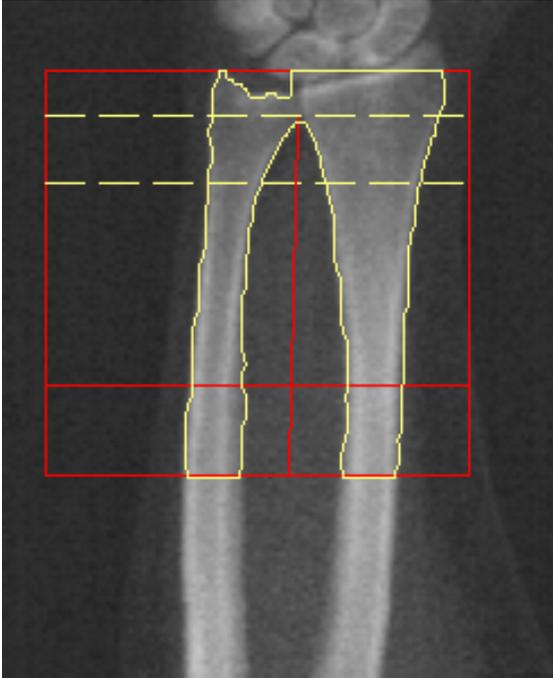

## 9.6 Viewing Results

Click **Results**.

## 9.7 Exiting Analysis

1. Click **Close**.
2. Click **Report**.

## 9.8 Generating and Printing Reports

See [Section 20 Reports](#) on Page 92.

## 10 Whole Body Examination

Start the exam as described in [Section 4.4 Using Worklist to Retrieve a Patient Record](#) on Page 12. In the Select **Scan Type** window, select **Whole Body**.

### 10.1 Body Composition Analysis

Hologic's Body Composition Analysis provides the ability to analyze the soft tissue composition of the entire body and to follow the changes in soft tissue composition over time in response to [interventions](#) such as diet and exercise. Analysis of fat mass, lean mass, and % fat mass can be reported for the entire body and head, arms, trunk, pelvis, and legs.

QDR whole body systems provide body composition results:

- Fat
- Lean combined with bone mineral content (BMC)
- Lean, (not including bone mineral content)
- %Fat. The % Fat is the fat mass divided by the total of the fat mass plus lean mass plus BMC.

The Hologic Visceral Fat Software estimates the visceral adipose tissue (visceral fat) content in adult males and nonpregnant females. The results are reported as:

- Visceral Fat Area
- Visceral Fat Mass
- Visceral Fat Volume

Due to the sensitivity of the soft tissue analysis, *the patient should wear only a hospital cloth or paper gown for the scan*. To the extent possible, tuck any clothing under the patient. If a sheet is used to cover the patient, the entire patient from the chin down including all extremities, are covered. A pillow must not be in the scan, since the material will affect the soft tissue measurement.

### 10.2 Positioning the Patient

1. Position the patient as shown ([Figure 27](#)).



**Note** *Instruct large patients to place their hands vertically at their sides with the fifth finger on the table pad. Their hands should be next to the thighs to ensure the hands and arms are within the table limits.*



**Warning:** *During the whole body exam, ensure that all patient body parts are at, or above, the surface of the examination table to avoid pinch points.*

2. Instruct the patient to remain still and breathe normally.

Figure 27 Whole Body Positioning

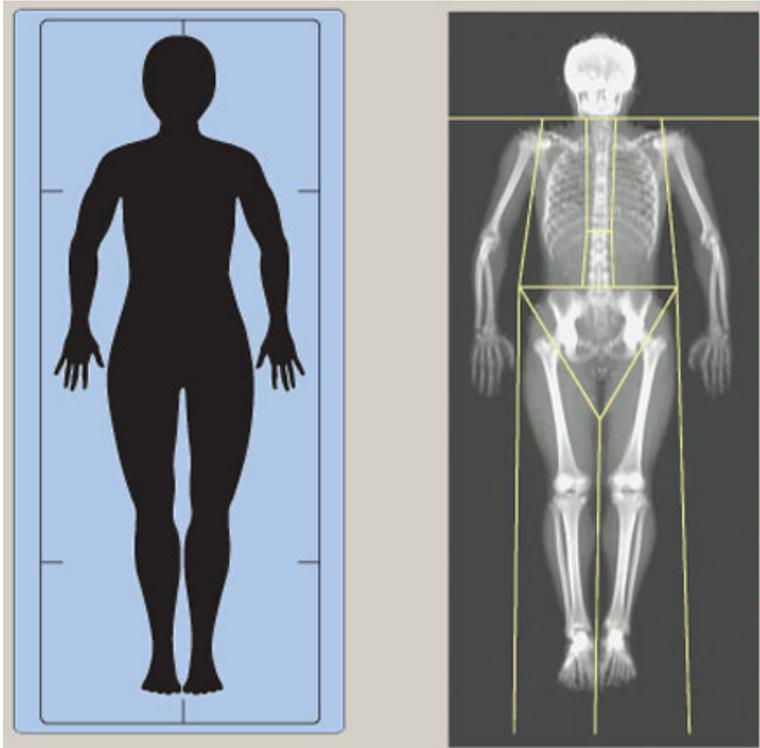

### 10.3 Starting the Whole Body Scan



**Warning:** *If the Control Panel X-ray indicator fails to shut off within 10 seconds after the end of the scan, press the red Emergency Stop button immediately. Call your Hologic service representative before resuming operation.*

1. Click **Start Scan**. The *X-rays On indicator* flashes until the scan stops.
2. Make sure the patient's arms are included in the scan on the C-arm's first and last pass. The patient should remain still until the scan is complete.

### 10.4 Whole Body Fan Beam Analysis

The default QDR system Whole Body Fan Beam Analysis method employs an Auto Whole Body feature that automatically adjusts the analysis for patients weighing from 17.6 lbs (8 Kg) to 88 lbs (40 Kg). Above 88 lbs the Auto Whole Body analysis provides results identical to previous whole body analysis versions. The software has not been evaluated for patients weighing less than 17.6 lbs and use on patients below this weight is not recommended.

Because Auto Whole Body automatically provides an improved analysis for patients less than 88 lbs (40 Kg), the Legacy PWB analysis method is no longer recommended in humans. Patients previously analyzed with Legacy PWB should be re-analyzed using Auto Whole Body because the reference database comparisons and Z scores will not be valid.



**Note** *If you are performing Whole Body Exams in subjects less than 40 kg, e.g. children, it is important to make sure that Auto Whole Body is not disabled in the System Configuration for Analyze. The default setting should be used, i.e., Auto Whole Body should be enabled.*

## 10.5 Analyzing the Scan



**Note** *Body Composition Analysis is performed at the same time as the Whole Body analysis. The Analysis window initially displays with Regions and Line Mode active.*

1. Click **Analyze Scan**.



**Note** *For descriptions of Analysis Step Buttons and Toolboxes, see [Section 6.1 Analysis Step Buttons](#) on Page 14.*

2. Click **Results**.

### 10.5.1 Body Composition Analysis

The same [anatomical regions](#) are used for calculating soft tissue values and Bone Mineral values. To correctly report the soft tissue values, [adjust the anatomical cut lines to include the soft tissue appropriate for that region](#). For example, adjust the leg regions such that the thigh tissue is located within the appropriate leg region, not the arm regions.

### 10.5.2 Default Placement of Whole Body Regions

When default placement is complete, the region lines should be checked for accuracy and adjusted if necessary. Refer to [Figure 28](#) and [Figure 29](#) for correct analysis.

To Check the Horizontal and Lower Pelvic Divider Lines ([Figure 28](#)),

1. Verify that the Neck line is just under the patient's jaw.
2. Verify that the T12-L1 line in the spine is at the approximate level of T12-L1.
3. Verify that the Upper Pelvic line is just above the iliac crest.
4. Verify that the Lower Pelvic divider lines separate the legs and trunk.

If adjustment is required, use the tools in the Regions Toolbox to click and drag the lines to their correct position.

Figure 28 Whole Body Analysis (Horizontal and Lower Pelvic Divider Lines)

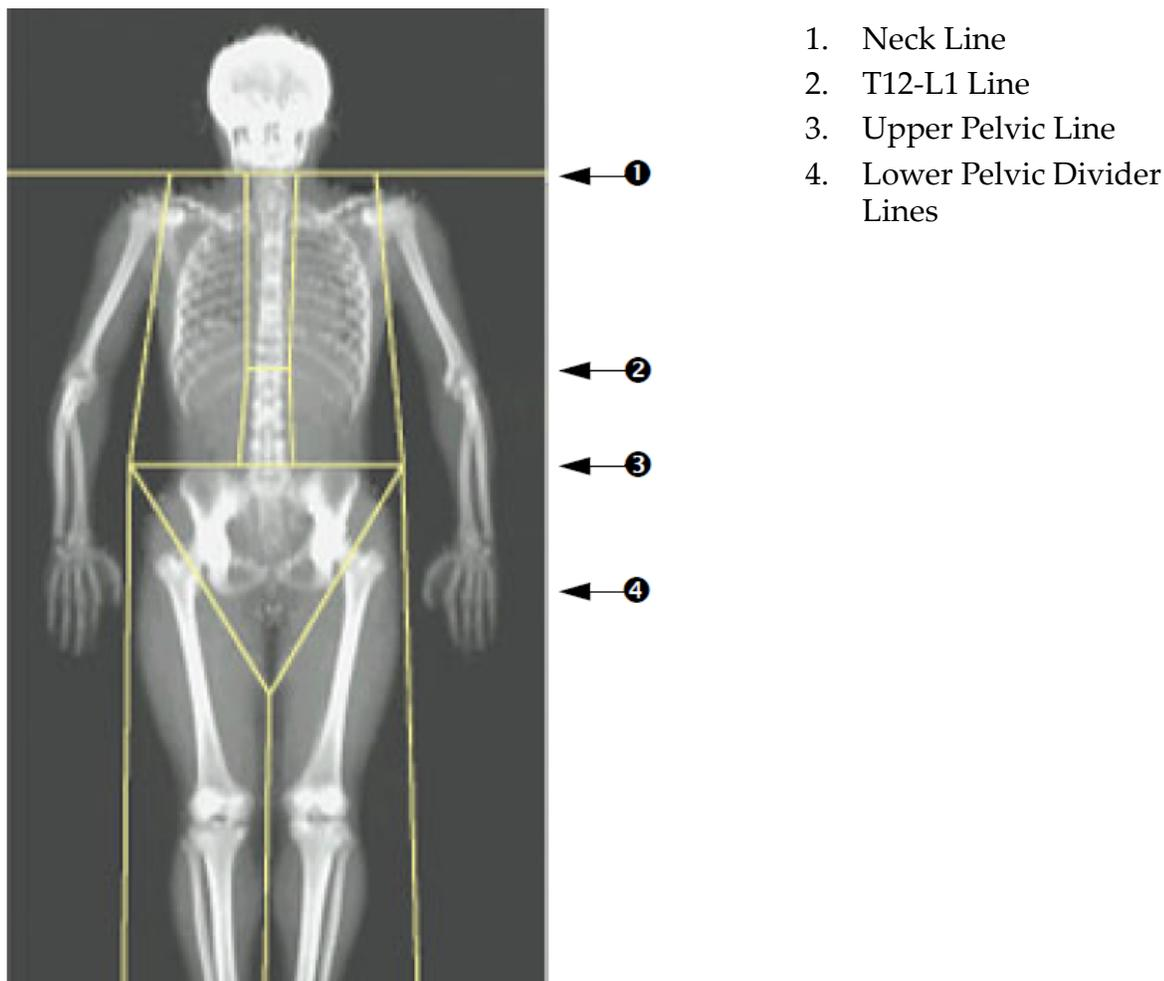

To Check the Vertical Lines ([Figure 29](#))

1. Verify that the chest lines are close to the chest.
2. Verify that the spine lines are close to the spine.
3. Verify that the leg lines are close to the leg.
4. Verify that the leg divider line evenly separates the legs and feet.

If adjustment is required, use the tools in the Regions Toolbox to click and drag the lines to their correct position.

**Figure 29 Whole Body Analysis (Vertical Lines)**

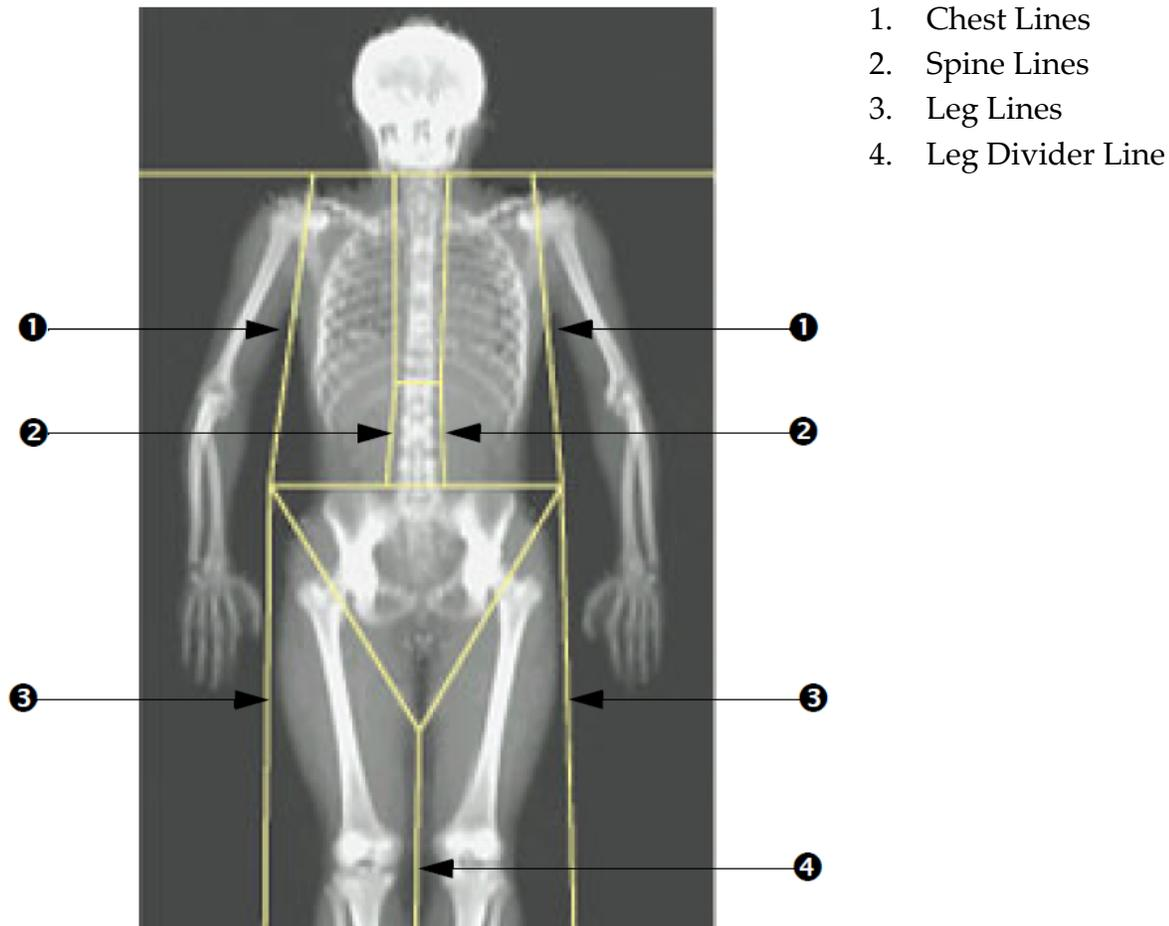

To Fine Tune the Vertical Lines (if necessary)

If necessary, use the Point Mode controls in the Regions Toolbox to adjust (fine tune) the vertical lines as follows:

1. Drag the point on the left shoulder so that it is positioned between the head of the humerus and scapula at the glenoid fossa. Repeat this step for the right shoulder.
2. Drag the three points along the left side of the spine close to the spine, matching the curvature if possible. Repeat this step for the three points along the right side of the spine.
3. If necessary, drag the left point above the iliac crest out at the sides to include soft tissue of the chest and thighs. Repeat for the right point above the iliac crest.
4. Drag the lower point of the triangle below the pelvis to bisect both femoral necks.
5. Use the scroll bar to scroll the image to the bottom of the scan. Drag the left and right points near the feet so as to include as much of the

soft tissue in the thighs as possible without including the patient's hand and fingers.

### 10.5.3 Adjusting A/G Regions (if necessary)

Click A/G Regions.



**Note** *Adjustment of the A/G regions is usually not required. Only adjust the A/G regions if necessary.*

Refer to Figure 30 and check the Android and Gynoid regions as follows:

Android ROI

1. The Android region height should equal 20% of the distance from the pelvic horizontal line to the neck line.
2. Ensure the lower boundary of the Android region coincides with the pelvic horizontal line.
3. Ensure the lateral boundaries of the Android region coincide with the arm lines.

Gynoid ROI

1. The Gynoid region height should equal twice the height of the Android region.
2. Ensure the upper boundary of the Gynoid region is below the pelvic horizontal line by 1.5 times the height of the Android region.
3. Ensure the lateral boundaries of the Gynoid region coincide with the arm lines.

If adjustment is required, use the tools in the Android/Gynoid SubRegion Toolbox to click and drag the lines to their correct position.

Figure 30 A/G Regions

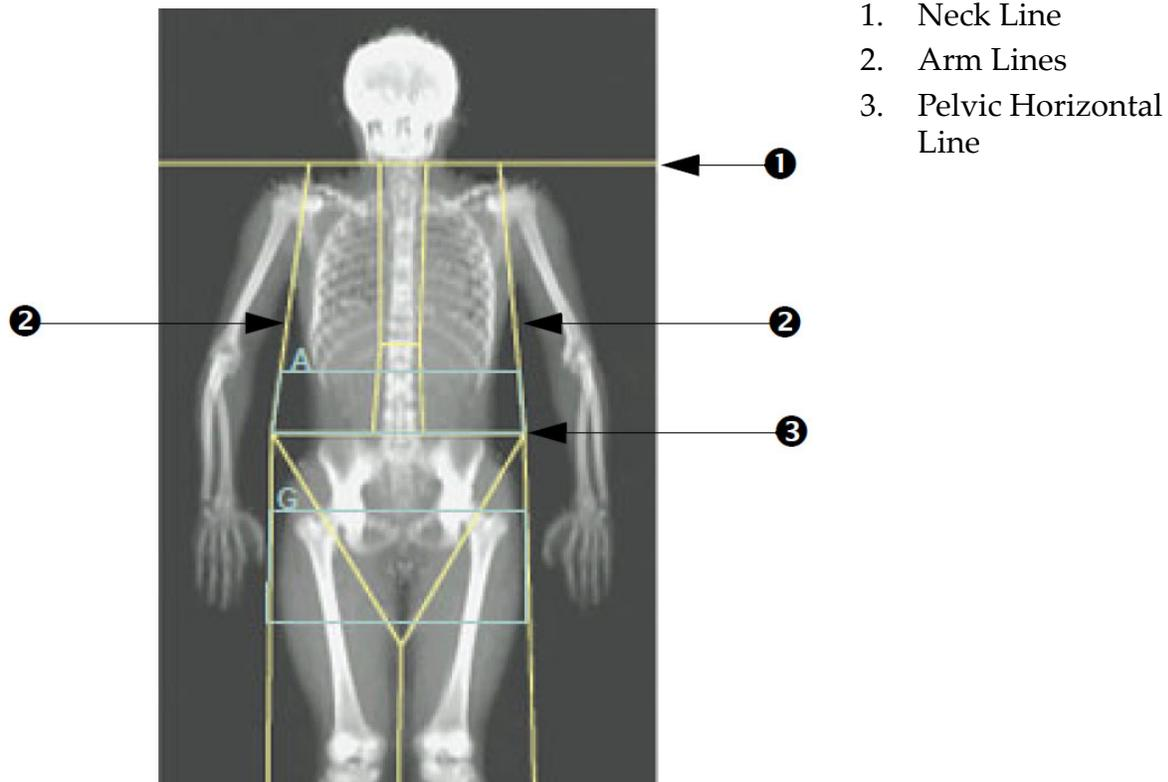

### 10.5.4 Visceral Adipose Tissue

Visceral Adipose Tissue (VAT) is the fat inside the abdominal cavity; *i.e. inside the abdominal muscle wall*. Horizon VAT area results are calibrated to, and highly correlated with, VAT area results provided by a computed tomography slice at the L4-L5 level (Figure 31).

The VAT regions occupy a band crossing the patient's abdominal cavity between the pelvis and the rib cage. One region covers the entire width of this band, from one side of the patient's body to the other. The other region includes only the interior of the abdominal cavity, from the inner edge of the abdominal muscle wall on one side of the body to the inner edge of the abdominal muscle wall on the other side (Figure 32).

VAT regions are available only in APEX 4.0, and higher, on Horizon A, W and Wi systems.



Figure 31 VAT Regions Pictured as CT Slice

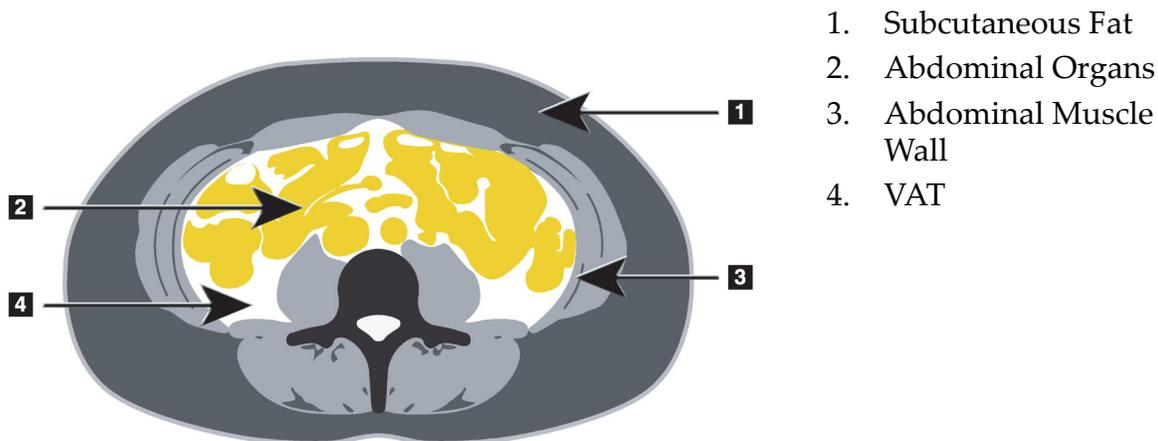

### 10.5.5 Adjusting VAT Regions (if necessary)



**Note** *Manual adjustment is usually not required. Avoid minor adjustments.*

1. Click A/G Regions.
2. Refer to [Figure 32](#) and adjust the image contrast and brightness so that you can see:
  - Abdominal muscles on either side of the visceral cavity.
  - Dark subcutaneous fat on the outer edge of the abdomen.

**Figure 32 Abdominal Tissue Features**

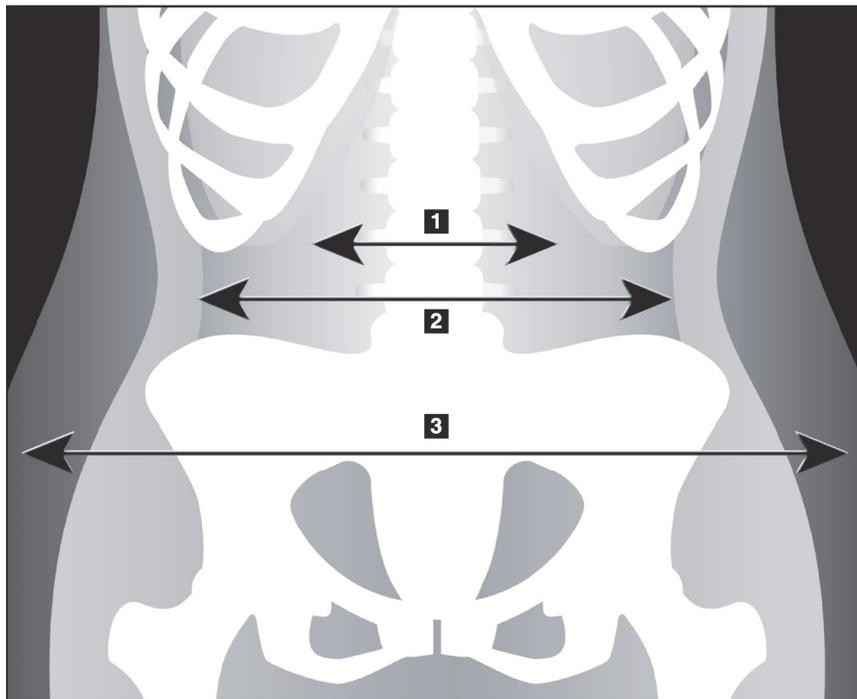

1. Visceral Cavity
2. Inner Abdominal Muscle Wall
3. Subcutaneous Fat

4. Ensure that the VAT regions do not include any pelvic bone. The pelvic cut line determines the vertical placement of the VAT regions. To adjust the pelvic cut line drag to just above the iliac crest.
5. Ensure that the abdominal region extends from the outer skin line of one side of the body to the outer skin line of the other side. The larger rectangle defines the abdominal region ([Figure 33](#)).
6. Ensure that the next set of lateral lines in the abdominal region is positioned at the edge of the laterally evident subcutaneous fat just outside the abdominal muscle wall. ([Figure 33](#)).
7. Ensure that the lateral lines that identify the visceral cavity are positioned at the inner edge of the abdominal muscle wall. ([Figure 33](#)).

Figure 33 VAT Regions

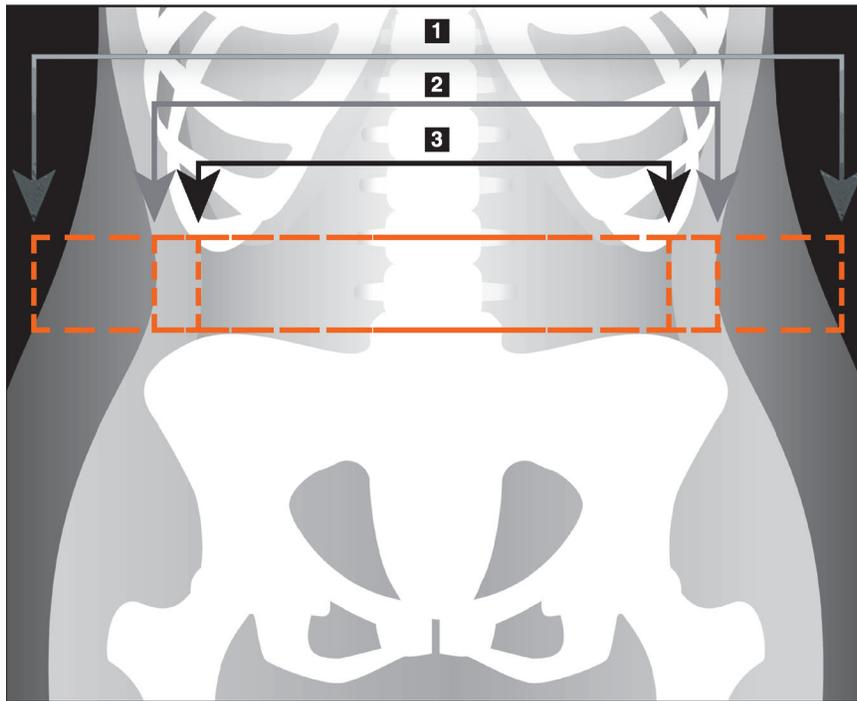

1. Abdominal Region
2. Edge of Subcutaneous Fat
3. Visceral Cavity

You can select and move the VAT vertical lines. Whole and line modes are available for the VAT option. Point mode is unavailable for this option.

### 10.5.6 VAT References

References related to the clinical utility of visceral fat estimation include:

- Sam S, Haffner S, Davidson MH, D'Agostino Sr RB, Feinstein S, Kondos, et al. "Relationship of Abdominal Visceral and Subcutaneous Adipose Tissue With Lipoprotein Particle Number and Size in Type 2 Diabetes." *Diabetes*, Vol. 57, August 2008
- Pascot A, Lemieux I, Prud'homme D, Tremblay A, Nadeau A, Couillard C, et al. "Reduced HDL particle size as an additional feature of the atherogenic dyslipidemia of abdominal obesity." *Journal of Lipid Research*, Volume 42, 2001
- Fox C, Massaro JM, Hoffmann U, Pou KM, Maurovich-Horvat P, Liu C, et al. "Abdominal Visceral and Subcutaneous Adipose Tissue Compartments: Association With Metabolic Risk Factors in the Framingham Heart Study" *Circulation* 2007, 116:39-48
- Preis S, Massaro JM, Robins SJ, Hoffmann U, Vasani RS, Irlbeck T. "Abdominal Subcutaneous and Visceral Adipose Tissue and Insulin Resistance in the Framingham Heart Study." *Obesity* (Silver Spring). 2010 November; 18(11): 2191–2198. doi:10.1038/oby.2010.59

- Nieves DJ, Cnop M, Retzlaff B, Walden CE, Brunzell JD, Knopp RH, Kahn SE. "The Atherogenic Lipoprotein Profile Associated With Obesity and Insulin Resistance Is Largely Attributable to Intra-Abdominal Fat." *Diabetes*, VOL. 52, January 2003
- Goodpaster BH, Krishnaswami S, Harris TB, Katsiaras A, Kritchevsky SB, Simonsick EM, et al. "Obesity, Regional Body Fat Distribution, and the Metabolic Syndrome in Older Men and Women." *ARCH INTERN MED*, Vol 165, Apr 11, 2005. WWW.ARCHINTERNMED.COM.

## 10.6 Viewing Results

Click **Results** and BMD to obtain Bone Mineral Density results.

Click BCA to obtain Body Composition results that include the regions plus the android and gynoid SubRegions.

### 10.6.1 Rulers

Rulers are placed on the Whole Body scan image to measure the patient's anatomy. Up to six rulers may be added.



**Note** *Rulers requires a special scan image not included in some earlier versions of APEX. Rulers are not available for those scans.*

#### To add a ruler:

1. Ensure that BMD is selected in the Results Toolbox and click **Rulers**. *The cursor changes to a cross when placed over the scan image.*
2. Place the cross on the image where the ruler will start and click and drag a line to place the ruler.

#### To select a ruler:

The cursor changes to a hand when placed directly on a ruler. With the hand cursor displayed, click to select a ruler.

#### To move a ruler:

Select the ruler. With the hand cursor displayed, click and drag the ruler to the desired location, or use the keyboard arrow keys to move the ruler up, down, left or right.

#### To select the endpoint of a ruler:

The cursor changes to an arrow at the endpoint of a ruler. With the arrow cursor displayed, click to select the endpoint.

### To change the size of a ruler:

With the arrow cursor displayed, click and drag the endpoint to the desired length and location, or use the keyboard arrow keys to move the endpoint up, down, left or right.

### To delete a ruler:

Select the ruler and click the keyboard Delete key, or, with the hand cursor displayed, right click and click Delete.

### To zoom the image:

With Rulers selected, click the **Sun/Moon** button and select the desired zoom factor using the Zoom control. The image can be sized to 100%, 144%, 200%, 288% or 400%. Click the **Sun/Moon** button again to return to ruler placement.

### Display Checkbox

With Rulers selected, this checkbox will be checked by default. With Rulers unselected, check to show rulers on the image. If unchecked, rulers do not appear on the image (rulers are not deleted, but not shown).

## 10.7 Exiting Analysis

If your analysis is complete, click **Close** to print a report or to analyze another scan. To create user-defined SubRegions, click **Sub Regions** and continue to [Section 10.8 User-Defined SubRegions](#) on Page 57.

## 10.8 User-Defined SubRegions

SubRegion analysis mode is a research tool developed to allow investigators to measure several user-defined regions of bone and soft tissue. Any area within the Whole Body scan can be analyzed. There can be up to seven SubRegions and they can overlap and have irregular shapes. If regions overlap then the net average will be the mathematical union of the individual regions.



**Note** For descriptions of Analysis Step Buttons and Toolboxes, see [Section 6.1 Analysis Step Buttons](#) on Page 14.

## 10.9 Resolving Asymmetric Results with Reflection

The asymmetric results warning message is displayed if a significant difference in mass is detected between the right and left arm (25%), or the right and left leg (15%).

**Figure 34 Asymmetric Results Warning**

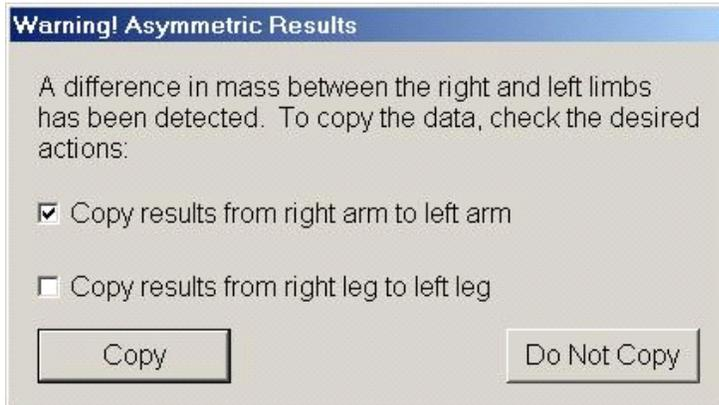

The possible causes of detection and resolutions include:

- The whole body analysis lines that separate the arms and legs are asymmetrically placed. Examine the lines used in the analysis and click Regions to adjust the arm and leg lines so they are symmetrical.
- Part of an arm or leg (usually at the hip) was outside of the scan field. In the warning screen you can select to copy the complete arm or leg to the arm or leg with missing information.
- The patient is asymmetrical (e.g. amputation, polio, etc.). In the case of a significantly asymmetrical patient, consult the physician to determine how results should be reported. Not copying provides the most accurate measurement of the patient, but copying may allow more accurate comparison to reference data for whole body measurements.

The system automatically determines which limbs are smaller. In the warning message dialog box you can select to copy the larger limb results to the smaller limb by checking one or both of the message check boxes.

In the warning message dialog box example, the mass of the right arm is significantly larger than the mass of the left, but the difference in the mass of the right and left leg was not large enough for the system to suggest copying. However, this box can be checked if you also want the system to copy the leg results.

Click Copy to perform the action indicated by the check boxes. Click Do Not Copy to close without changing any results. Results that are copied from one arm or leg to the other are indicated on the report. Accuracy and precision may be affected by copying from one side to the other. However, depending on body habitus of the subject, copying may give the most accurate results.

## 10.10 Enable NHANES BCA

To enable NHANES BCA go to the APEX Main Menu, select Utilities, System Configuration, Analyze tab and check the Enable NHANES BCA check box. Select this option to apply the calibration recommended by Schoeller *et al.*<sup>1</sup> When enabled, NHANES BCA will be noted in the BCA results section.

## 10.11 Generating and Printing Reports

See [Section 20 Reports](#) on Page 92.

- 
1. Schoeller DA, Tylavsky FA, Baer DJ, Chumlea WC, Earthman CP, Fuerst T, Harris TB, Heymsfield SB, Horlick M, Lohman TG, Lukaski HC, Shepherd J, Siervogel RM, Borrud LG "QDR 4500A dual-energy X-ray absorptiometer underestimates fat mass in comparison with criterion methods in adults." *Am J Clin Nutr.* 2005;81(5):1018-25.

# 11 Supine AP/Lateral Spine BMD Examination (Horizon A)

## 11.1 Table Safety Feature

C-arm motion stops if you or the patient touch the safety strips along either edge of the table. If this happens, press **Enable Lateral** to complete C-arm rotation.

## 11.2 Positioning for the AP/Lateral Scan

Start the exam as described in [Section 4.4 Using Worklist to Retrieve a Patient Record](#) on Page 12. In the Select **Scan Type** window, select **AP/Lateral**.

1. On the Control Panel, press **Patient On/Off**.
2. Place the patient on their back with their head at the right end of the table.
3. On the Control Panel, press **Center**.
4. Position the patient as shown ([Figure 35](#))



**Note**      *The patient must not move between the AP and lateral scans.*



Figure 35 AP/Lateral Spine Positioning



### 11.3 Starting the AP Scan

1. On the Control Panel, press **Enable Lateral**.
2. Click **Continue**.
3. Refer to [Section 7.3 Starting the AP Lumbar Spine Scan](#) on Page 21 and complete the scan.

### 11.4 Analyzing the AP Scan

1. Click **Next >>**.
2. Click **Close**.
3. Continuously press **Enable Lateral** on the Control Panel until the C-arm has rotated fully to the lateral scan position.

### 11.5 Starting the Lateral Scan



**Warning:** *If the Control Panel X-ray indicator fails to shut off within 10 seconds after the end of the scan, press the red Emergency Stop button immediately. Call your Hologic service representative before resuming operation.*

1. Click **Start Scan**. The X-rays *On* indicator flashes until the scan stops.

2. When L2 to L4 is fully displayed ([Figure 36](#)), click **Stop Scan**.

**Figure 36 Lateral Spine**

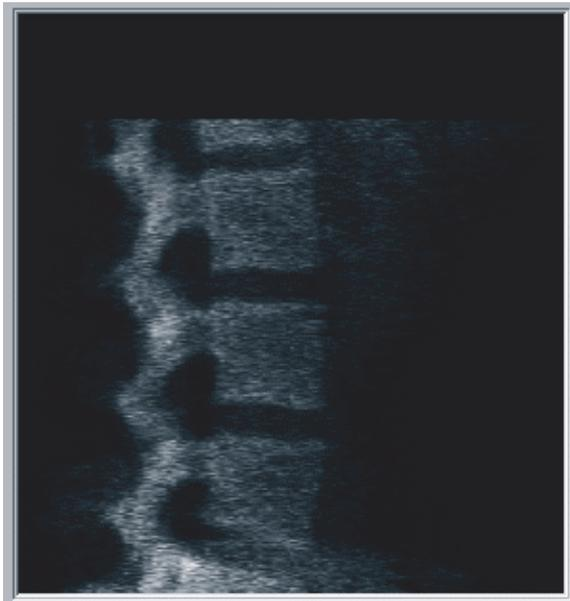

3. Continuously press **Enable Lateral** on the Control Panel until the C-arm has rotated to its original position.

## 11.6 Analyzing the Lateral Scan

1. Click **Analyze Scan**.
2. Click **Next >>**.



**Note** *For descriptions of Analysis Step Buttons and Toolboxes, see [Section 6.1 Analysis Step Buttons](#) on Page 14.*

### 11.6.1 Defining the Global ROI

1. Click **Global ROI**.
2. Using the **Whole Mode** and **Line Mode** tools, adjust the ROI as shown in [Figure 37](#).

Figure 37 Lateral ROI

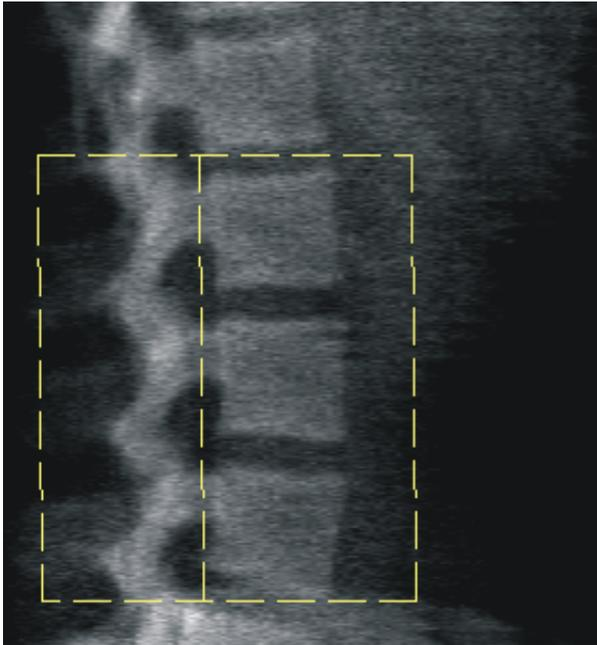

### 11.6.2 Adjusting the Vertebral Boundaries

1. Click **Vertebral Boundaries and Ant. Boundary**.
2. Using **Line Mode** and **Point Mode** tools, adjust the Vertebral Boundaries as shown in [Figure 38](#).

Figure 38 Vertebral Boundaries

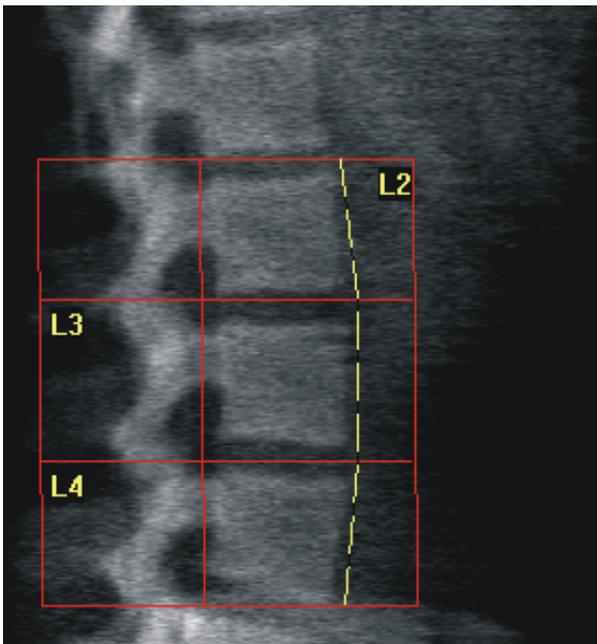

#### 11.6.3 Adjusting the Vertebral Bodies

1. Click **Vertebral Bodies**.
2. Using **Line Mode** and **Point Mode** tools, adjust the Vertebral Bodies as shown in [Figure 39](#).

**Figure 39** Vertebral Bodies

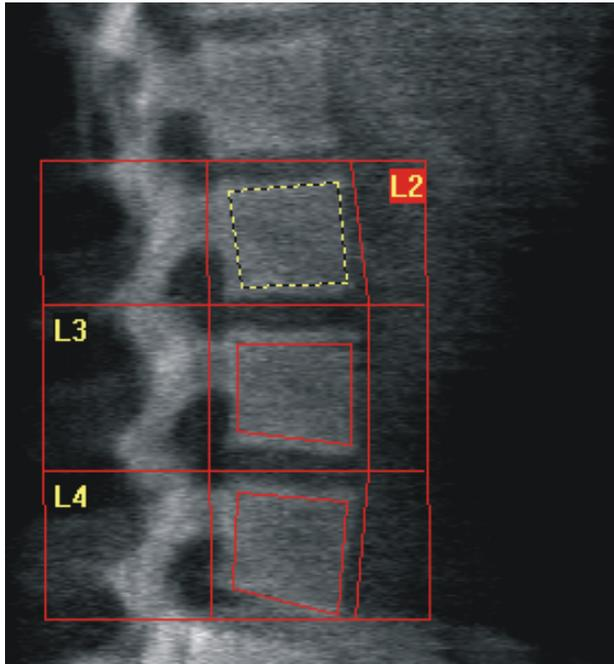

#### 11.6.4 Viewing the Bone Map

1. Click **Bone Map**.
2. If the bone map is incomplete for the vertebral bodies, adjust the boxes as shown in [Figure 39](#). In most cases it will not be necessary to edit the bone map.

Figure 40 Lateral Bone Map

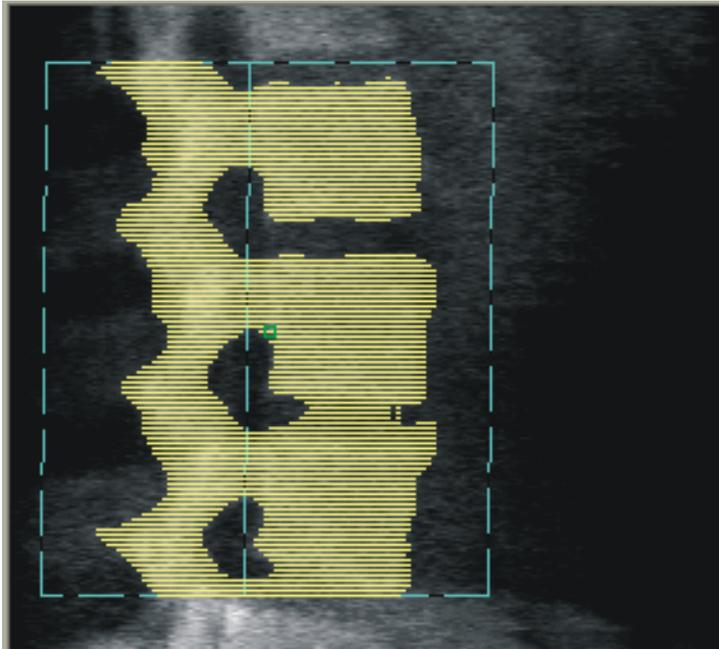

### 11.6.5 Adjusting the Mid Regions

If activated, use the **Mid Regions** button and **Whole Mode**, **Line Mode** and **Point Mode** tools to adjust the regions that report bone density in the middle of the vertebral bodies ([Figure 39](#)).



**Note** *Mid Regions can be activated in the Utilities Menu, System Configuration, Analyze Tabs.*

## 11.7 Viewing Results

1. Click **Results**.
2. Click **BMD** to display BMD results or **WA-BMD** to display width-adjusted BMD results.

## 11.8 Exiting Analysis

1. Click **Close**.
2. Click **Report**.

## 11.9 Generating and Printing Reports

See [Section 20 Reports](#) on Page 92.

## 12 Decubitus Lateral Spine BMD Examination

Start the exam as described in [Section 4.4 Using Worklist to Retrieve a Patient Record](#) on Page 12. In the Select **Scan Type** window, select **AP/Decubitus**.

### 12.1 Performing and Analyzing the AP Scan

The AP part of the decubitus lateral spine scan is performed the same as an AP lumbar spine scan. Refer to [Section 7 AP Lumbar Spine Examination](#) on Page 19 and follow the procedure until the AP analysis is complete.

### 12.2 Positioning the Patient for the Decubitus Lateral Scan

1. Position the patient as shown ([Figure 41](#) and [Figure 42](#)).
2. Place a pillow under the head to square the shoulders and to keep the spine parallel to the table.
3. Flex the patient's knees about 90 degrees.
4. Extend the patient's upper arms 90 degrees from midcoronal plane.
5. Adjust the body to a true lateral position.

**Figure 41 Decubitus Lateral Positioning**

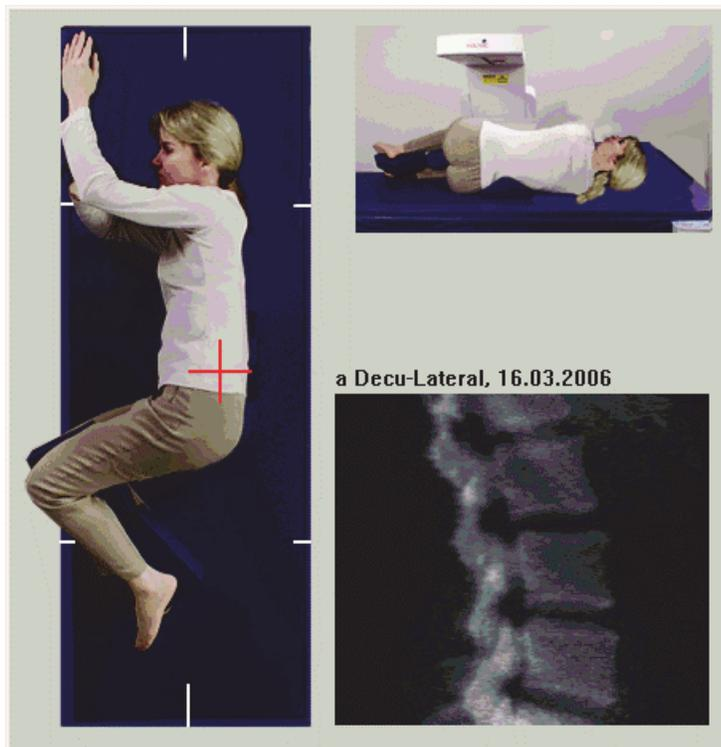
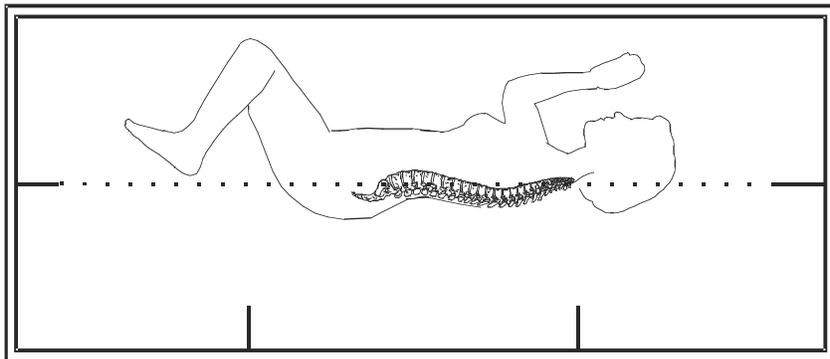

Figure 42 Spine Position



### 12.3 Positioning the C-arm for the Decubitus Lateral Scan

1. Position the C-arm as shown (Figure 41).
2. Turn on the laser.
3. Position the cross hairs of the laser 5 cm (2 inches) below the iliac crest and centered over the spine.
4. Move the laser cross hairs 2.5 cm (1 inch) toward the back of the patient.
5. Click **Continue**.

### 12.4 Starting the Decubitus Lateral Scan



**Warning:** *If the Control Panel X-ray indicator fails to shut off within 10 seconds after the end of the scan, press the red Emergency Stop button immediately. Call your Hologic service representative before resuming operation.*

1. Click **Start Scan**. The *X-rays On indicator* flashes until the scan stops.
2. Inspect the image as it is generated. When L2 to L4 is fully displayed, click **Stop Scan**.
3. Upon completion of an acceptable lateral image (Figure 43), assist the patient off the table.

**Figure 43 Decubitus Spine**



### 12.4.1 Repositioning the Scan (if necessary)

1. Click **Reposition Scan**.
2. Position the cursor over the spine image ([Figure 44](#)).

**Figure 44 Decubitus Repositioning**

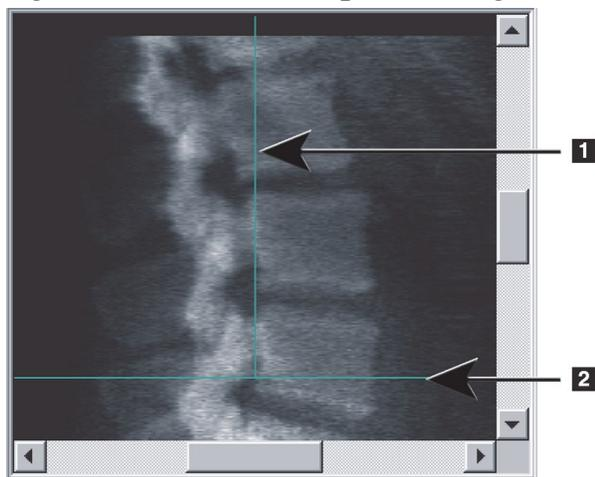

3. To reposition, click and drag the image so that:
  - The iliac crest is at or below the blue horizontal positioning line [1] and within the lower portion of the scan field.
  - The center of the spine is aligned with the blue vertical positioning line [2].
4. When the spine is positioned correctly, click **Restart Scan** and repeat the scan.



## 12.5 Analyzing the Scan

1. Click **Analyze Scan**.
2. Click **Next >>**.



**Note** For descriptions of *Analysis Step Buttons and Toolboxes*, see [Section 6.1 Analysis Step Buttons](#) on Page 14.

### 12.5.1 Defining the Global ROI

1. Click **Global ROI**.
2. Using the **Whole Mode**, **Line Mode** and **Point Mode** tools, adjust the ROI ([Figure 45](#)).

**Figure 45 Lateral ROI**

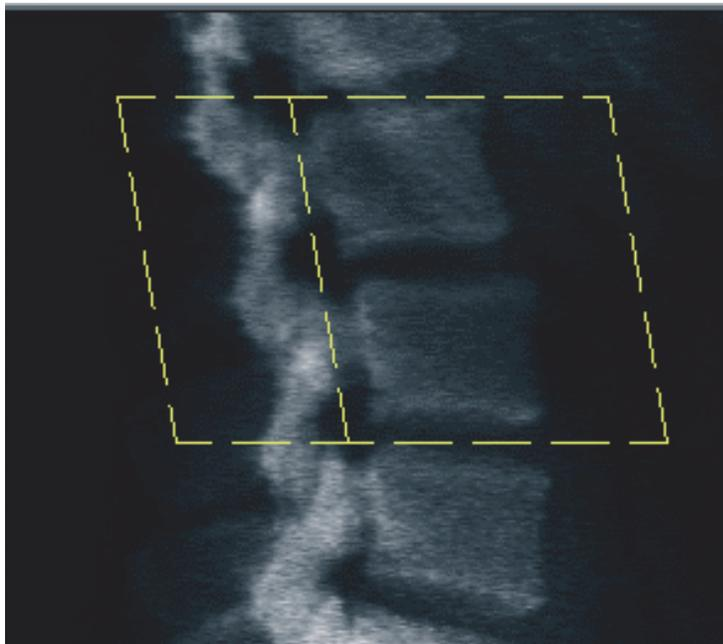

### 12.5.2 Adjusting the Vertebral Boundaries

1. Click **Vertebral Boundaries** and **Ant. Boundary**.
2. Using **Line Mode** and **Point Mode** tools, adjust the **Vertebral Boundaries** as shown in [Figure 46](#).

**Figure 46 Vertebral Boundaries**

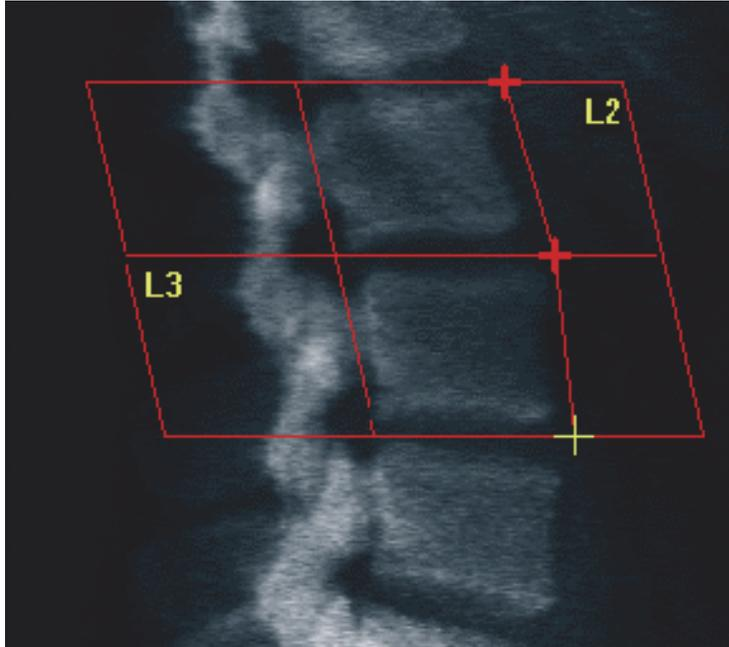

### 12.5.3 Adjusting the Vertebral Bodies

1. Click **Vertebral Bodies**.
2. Using **Whole Mode**, **Line Mode** and **Point Mode** tools, adjust the Vertebral Bodies ([Figure 47](#)).

**Figure 47 Vertebral Bodies**

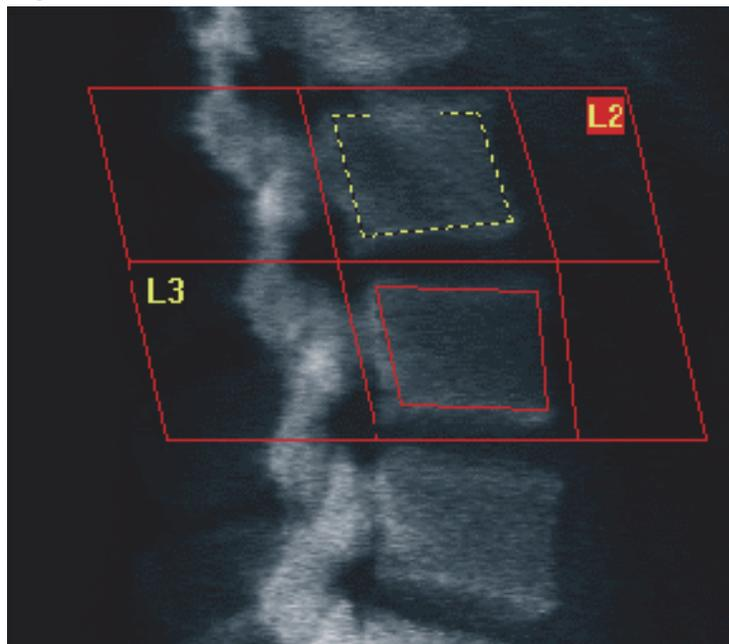

#### 12.5.4 Viewing the Bone Map

1. Click **Bone Map**.
2. In most cases it will not be necessary to edit the bone map.  
If it is required, click **Vertebral Bodies** and re-adjust **L2** or **L3**, so they are just inside the bone edges.

**Figure 48 Lateral Bone Map**

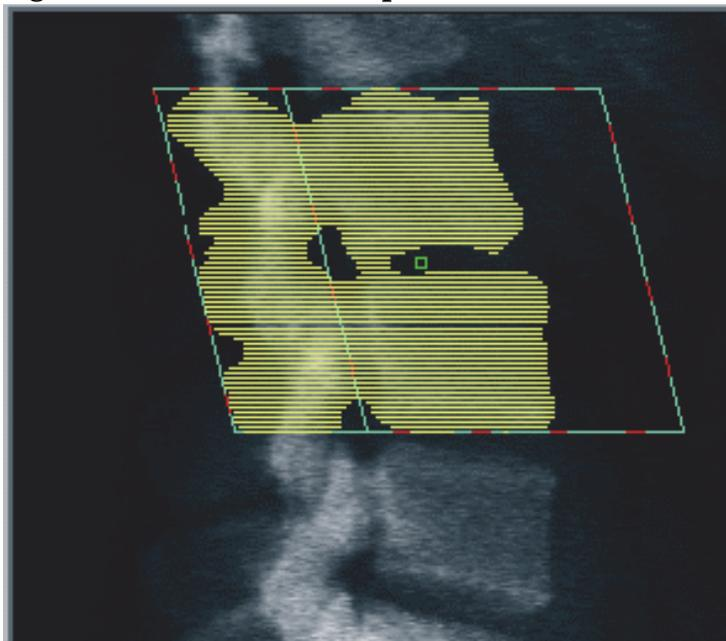

#### 12.6 Viewing Results

Click **Results**.

#### 12.7 Exiting Analysis

1. Click **Close**.
2. Click **Report**.

#### 12.8 Generating and Printing Reports

See [Section 20 Reports](#) on Page 92.

## 13 IVA, IVA HD Imaging on Horizon C, W; IVA Imaging on Horizon Ci, Wi

Start the exam as described in [Section 4.4 Using Worklist to Retrieve a Patient Record](#) on Page 12. In the **Select Scan Type** window, select **IVA Imaging**.

### 13.1 Choosing the Scan Type

1. In the **Select Scan Type** window, remove the check mark in the **Use Default Scan Mode** box.
2. Click **Next >>**.
3. In the **Include SE AP Spine Scan in IVA Exam?** window, click **SE AP Image**.
4. Click **Next >>**.
5. In the **Include SE Lateral Spine Scan in IVA Exam?** window, click **SE Lateral Image**.
6. Click **Next >>**. The **Scan Parameters** window for the AP IVA scan displays.

### 13.2 Positioning the Patient for the AP IVA Scan

Position the patient and C-arm as described in [Section 7.3 Starting the AP Lumbar Spine Scan](#) on Page 21 *with the following exception*: the patient's shoulders should be positioned below the upper scan limit ([Figure 49](#)).

Figure 49 AP IVA Positioning

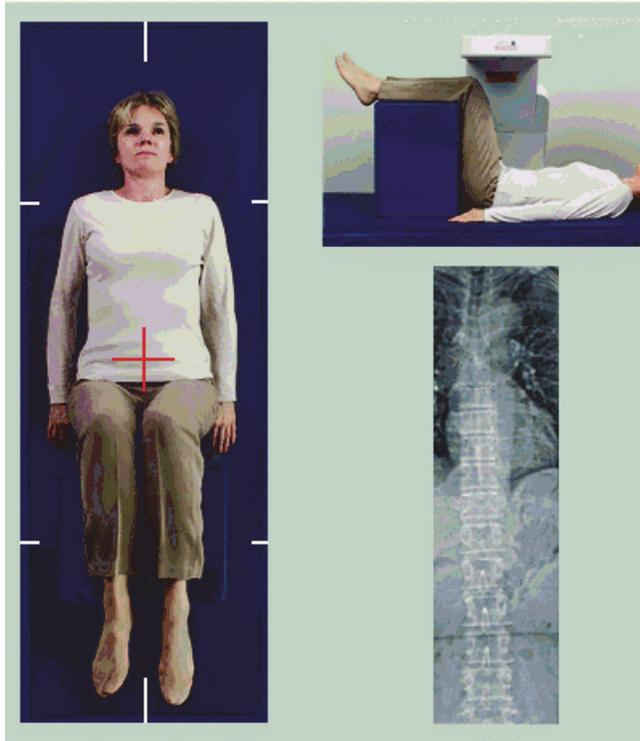

### 13.3 Starting the AP IVA Scan



**Warning:** *If the Control Panel X-ray indicator fails to shut off within 10 seconds after the end of the scan, press the red Emergency Stop button immediately. Call your Hologic service representative before resuming operation.*

1. Ask the patient to hold their breath during the scan.
2. Click **Start Scan**. The **X-rays On indicator** flashes until the scan stops.
3. Inspect the image.
4. When you see **L4** through **T4** on the image, click the **Stop Scan** button and tell the patient to breathe normally.
5. Click **Close**.

### 13.4 Positioning the Patient and C-arm for the Lateral IVA Scan

1. Position the patient as shown in [Figure 50](#) and [Figure 51](#).
2. Flex the patient's knees about 90 degrees.
3. Extend the patient's upper arms 90 degrees from midcoronal plane.
4. Adjust the body to a true lateral position.

Figure 50 Lateral IVA Positioning

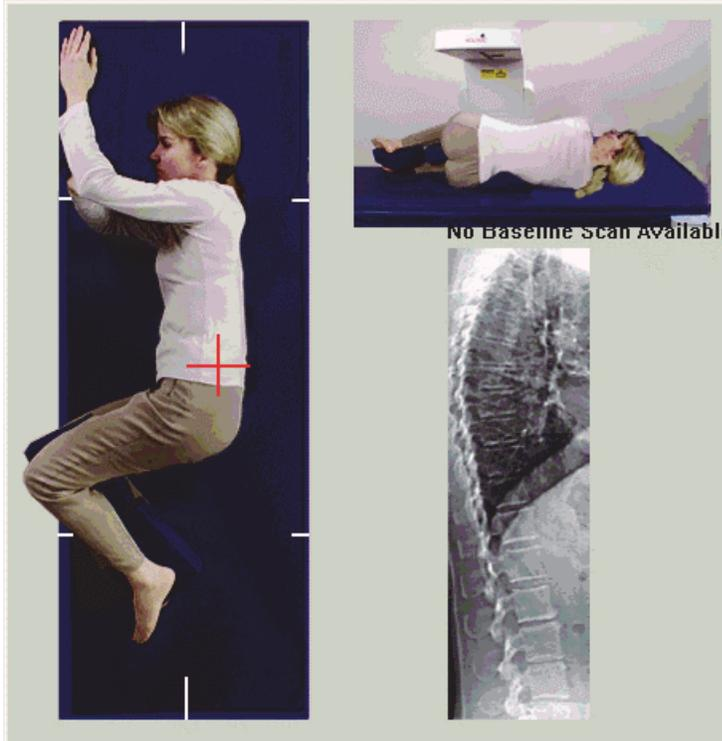
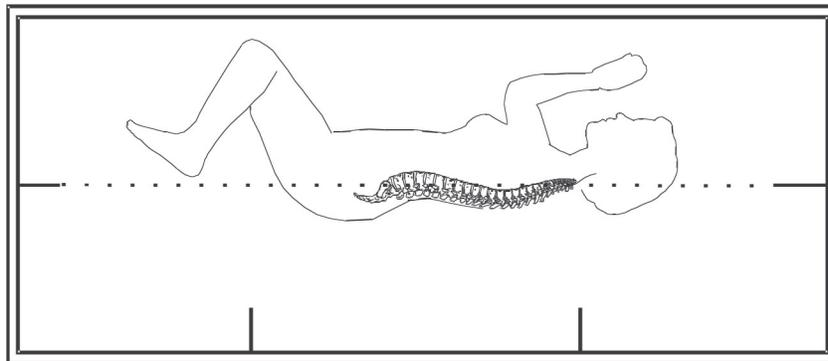

Figure 51 Spine Position



## 13.5 Starting the Lateral IVA Scan



**Warning:** *If the Control Panel X-ray indicator fails to shut off within 10 seconds after the end of the scan, press the red Emergency Stop button immediately. Call your Hologic service representative before resuming operation.*

1. Ask the patient to hold their breath during the ten second scan.
2. Click **Start Scan**. The *X-rays On indicator* flashes until the scan stops.

## 13.6 IVA Analysis for Lateral IVA Scan

See [Section 16 IVA Analysis](#) on Page 79.

# 14 IVA and IVA HD Imaging on a Horizon A System

Start the exam as described in [Section 4.4 Using Worklist to Retrieve a Patient Record](#) on Page 12. In the **Select Scan Type** window, select **IVA Imaging**.

## 14.1 Positioning the Patient

Position the patient as described in [Section 11.2 Positioning for the AP/ Lateral Scan](#) on Page 60 *with the following exception*: the patient's shoulders should be positioned below the upper scan limit line.

Figure 52 AP IVA Positioning

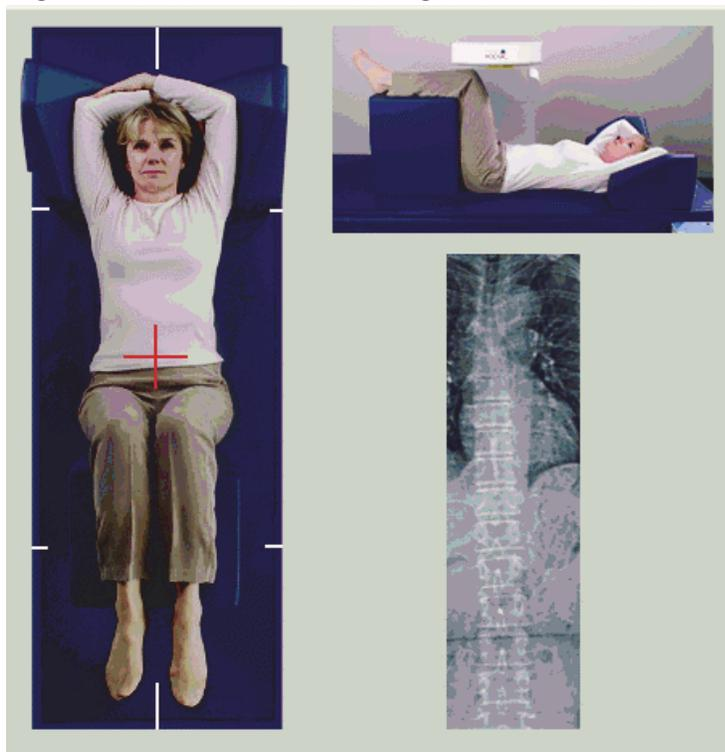

## 14.2 Choosing the Scan Type

1. In the **Select Scan Type** window, remove the check mark in the **Use Default Scan Mode** box.
2. Click **Next >>**.

3. In the **Include SE AP Spine Scan in IVA Exam?** window, click **SE AP Image**.
4. Click **Next >>**.
5. In the **Include SE Lateral Spine Scan in IVA Exam?** window, click **SE Lateral Image**.
6. Click **Next >>**. The *Continuously Press ENABLE...* message displays.

Once **Enable Lateral** is pressed the table is locked. Only the C-arm can move. If necessary, move the patient to the long axis of the laser cross hair.

### 14.3 Starting the AP IVA Scan



**Warning:** *If the Control Panel X-ray indicator fails to shut off within 10 seconds after the end of the scan, press the red Emergency Stop button immediately. Call your Hologic service representative before resuming operation.*

1. Ask the patient to hold their breath during the scan.
2. Click **Start Scan**. The *X-rays On indicator* flashes until the scan stops.
3. Inspect the image.
4. When you see L4 through T4 on the image, click the **Stop Scan** button and then tell the patient to breathe normally.
5. Click **Close**. The *Continuously Press ENABLE...* message displays.
6. Continuously press **Enable Lateral** on the Control Panel until the C-arm has rotated fully to the lateral scan position.



Figure 53 Lateral IVA Positioning

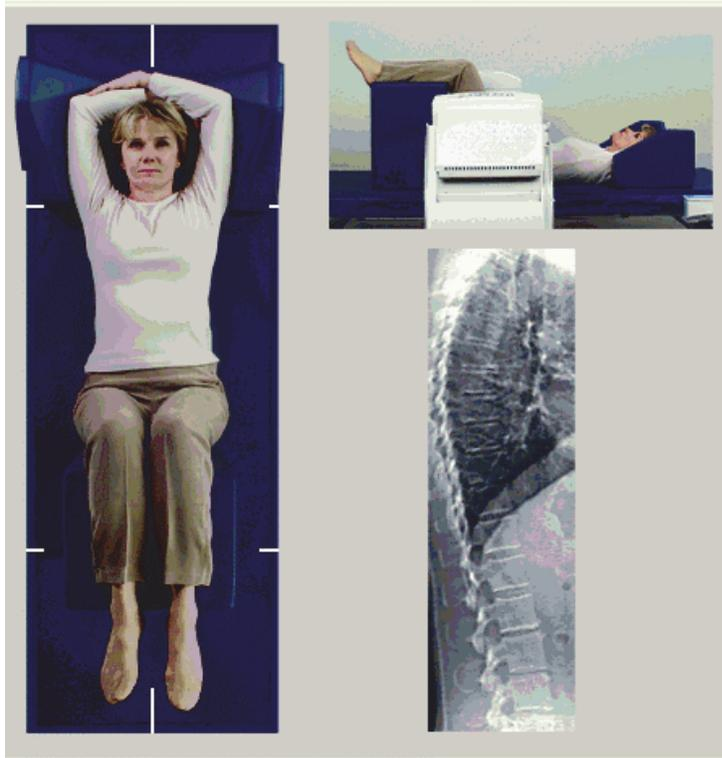

## 14.4 Starting the Lateral IVA Scan



**Warning:** *If the Control Panel X-ray indicator fails to shut off within 10 seconds after the end of the scan, press the red Emergency Stop button immediately. Call your Hologic service representative before resuming operation.*

1. Ask the patient to hold their breath during the ten second scan.
2. Click **Start Scan**. The *X-rays On indicator* flashes until the scan stops.
3. Inspect the image.
4. When you see **L4** through **T4** on the image, click the **Stop Scan** button and then tell the patient to breathe normally.
5. Continuously press **Enable Lateral** on the Control Panel until the C-arm has rotated to its original position.
6. Click **Exit**.
7. Press **Patient On/Off** on the Control Panel and, when motion stops, assist the patient off the table.

## 14.5 IVA Analysis for Lateral IVA Scan

See [Section 16 IVA Analysis](#) on Page 79.

## 15 IVA with BMD Examination

Start the exam as described in [Section 4.4 Using Worklist to Retrieve a Patient Record](#) on Page 12. In the **Select Scan Type** window, select **IVA with BMD**.

Hologic recommends performing scans in the following order:

1. an AP IVA scan
2. an AP BMD scan
3. a Lateral BMD scan, and
4. a Lateral IVA scan

### 15.1 Positioning the Patient

Position the patient as described in [Section 11.2 Positioning for the AP/Lateral Scan](#) on Page 60 *with the following exception*: the patient's shoulders should be positioned below the upper scan limit line.

### 15.2 Choosing the Scan Type

1. In the **Select Scan Type** window, remove the check mark in the **Use Default Scan Mode** box.
2. Click **Next >>**.
3. In the **Include SE AP Spine Scan in IVA Exam?** window, click **SE AP Image**.
4. Click **Next >>**.
5. In the **Select AP Lumbar Spine Scan Mode** window, click **Express (x)**.
6. Click **Next >>**.
7. In the **Select Lateral Scan Mode for AP/Lateral Exam** window click **Fast Array (f)**.
8. Click **Next >>**.
9. In the **Include SE Lateral Spine Scan in IVA Exam?** window, click **SE Lateral Image**.
10. Click **Next >>**. The *Continuously Press ENABLE...* message displays.

### 15.3 Perform the AP IVA Scan

Perform the AP IVA scan as described in [Section 14 IVA and IVA HD Imaging on a Horizon A System](#) on Page 75, starting with [Section 14.1 Positioning the Patient](#) on Page 75.

Once **Enable Lateral** is pressed the table is locked. Only the C-arm can move. If necessary, move the patient to the long axis of the laser cross hair.

## 15.4 Perform and Analyze the AP BMD Scan

Perform and analyze the AP BMD scan as described in [Section 7.3 Starting the AP Lumbar Spine Scan](#) on Page 21 and [Section 7.4 Analyzing the Scan](#) on Page 22.

## 15.5 Perform the Lateral BMD Scan

Perform the Lateral BMD scan as described in [Section 11.5 Starting the Lateral Scan](#) on Page 61.

## 15.6 Perform the Lateral IVA Scan

Perform the Lateral IVA scan as described in [Section 14.4 Starting the Lateral IVA Scan](#) on Page 77.

## 15.7 IVA Analysis

See [Section 16 IVA Analysis](#) on Page 79.

# 16 IVA Analysis

The Viewer window ([Figure 54](#)) is described in [Table 16](#).

**Figure 54 IVA Viewer Window**

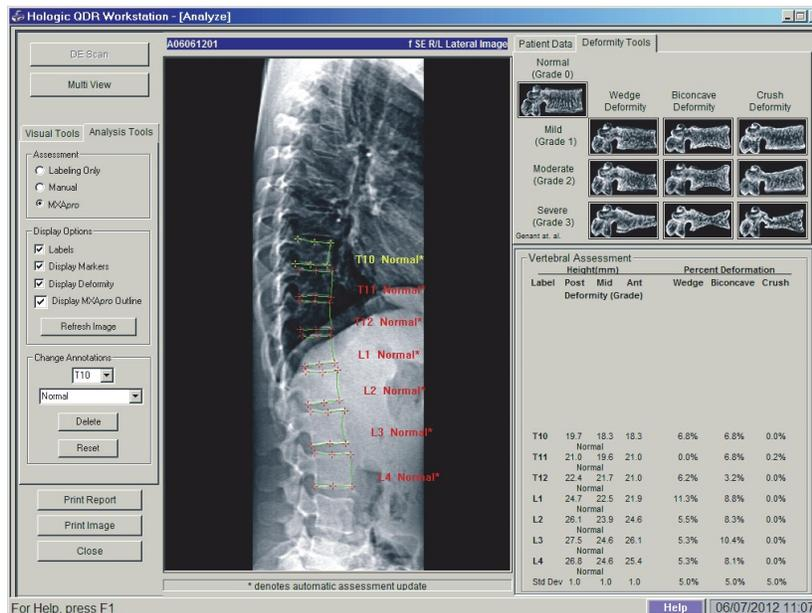

## 16.1 Viewer Window, Left Panel

Table 16 Viewer Window, Left Panel

Control	Description
DE Scan	Used on Lateral IVA Scan only ( <a href="#">Section 16.7 DE Scan</a> on Page 84).
Multi View Button	Click to toggle between Multi View and Single View.
Visual Tools Tab	Click to display the visual tools ( <a href="#">Section 16.4 Viewer Window, Left Panel, Visual Tools Tab</a> on Page 81).
Analysis Tools Tab	Click to display analysis tools (see <a href="#">Section 16.5 Viewer Window, Left Panel Analysis Tools Tab</a> on Page 81)
Print Report	Prints the report to the selected printer.
Print Image	Prints the image to the selected printer.
Close	Exits the analysis window and returns to the main window, saving any changes made to the scan.

## 16.2 Viewer Window, Middle Panel

Table 17 Viewer Window, Middle Panel

Control	Description
Image Display Area	<i>Displays the image from the selected scan. Right click on the image to display the image control menus (<a href="#">Section 16.6 Image Controls</a> on Page 83).</i>
Scan ID	Appears above the image on the left.
Scan Type	Appears above the image on the right.

## 16.3 Viewer Window, Right Panel

Table 18 Viewer Window, Right Panel

Control	Description
Patient Data Tab	Click to display patient data.
Deformity Tools Tab	Click to display deformity identification reference images and the results for each vertebra analyzed in the image.
Multi View Enabled	The viewer displays an image in both the middle and right panels.

## 16.4 Viewer Window, Left Panel, Visual Tools Tab

Table 19 Viewer Window, Left Panel, Visual Tools Tab

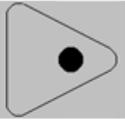
Control	Description
<p>W-L</p> 	<p><i>Click and drag the "ball" in the center of the triangle to adjust the contrast and brightness of the image. For finer adjustment:</i></p> <ol style="list-style-type: none"> <li><i>1.Right click on the image.</i></li> <li><i>2.Click Adjust WL.</i></li> <li><i>3.Click and drag the cursor on the image.</i></li> </ol>
Revert	Returns all viewing parameters to their initial values.
Invert	Inverts the grayscale value of each pixel creating a negative of the image.
Flip	Flips the image about the center vertical axis.
	Click to increase the magnification of the image.
	Click to decrease the magnification of the image.

## 16.5 Viewer Window, Left Panel Analysis Tools Tab

Table 20 Assessment Area

Control	Description
Radio button controls that determine how vertebral annotations will be placed on the image. See the following descriptions:	
Labeling Only	Position the cursor and click to place a vertebral label. Click and drag to move the label, right click to change it or add an assessment.
Manual	Position the cursor in the center of a vertebra, and click to place a vertebral label and markers. Click between markers and drag to move the label and markers together. Click on a marker and drag to move it individually. Right click to change the label or add an assessment.

**Table 20 Assessment Area**

Control	Description
<b>MXApro</b>	Position the cursor in the center of a vertebra, and click to place a vertebral label, markers, a vertebral outline (in green), and a deformity assessment based on the ratio calculated. Click between markers and drag to move everything together. Click on a marker and drag to move it until it is in the proper position ( <a href="#">Section 18 Markers</a> on Page 86). Right click to change the label or assessment. The asterisk indicates that the assessment is based on the ratios calculated from the vertebral heights. The vertebral deformity assessment is at the sole discretion of the physician or trained health care professional. Before printing or reporting, assessments must be changed or accepted by the physician. See <a href="#">Section 17 Interpreting the IVA Image</a> on Page 84 for assessment guidelines.

**Table 21 Display Options Area**

Control	Description
Controls that determine what vertebral annotations display on the images (see the following descriptions).	
<b>Labels</b>	Check to display all labels on the image.
<b>Display Markers</b>	Check to display all markers on the image.
<b>Display Deformity</b>	Check to display all deformity assessments on the image.
<b>Display MXApro Outline</b>	Check to display all MXApro outlines on the image. The outline is the software's estimation of the vertebral edges that it used for marker placement.
<b>Refresh Image Button</b>	Click to apply the selected display options to the last analyzed vertebrae (shows how the image will appear when viewed or printed).

**Table 22 Change Annotations Area**

Control	Description
Controls to change vertebral labels and assessments on selected vertebral annotations (see the following descriptions).	
<b>Label Selection Drop Down List</b>	Click on the down arrow to change the label of the selected vertebral analysis.
<b>Assessment Selection Drop Down List</b>	Click on the down arrow to change the deformity assessment of the selected vertebral analysis.

**Table 22 Change Annotations Area**

Control	Description
<b>Delete Button</b>	Click to delete one or more selected vertebral analyses.
<b>Reset Button</b>	Click to remove all the new vertebral analyses and display the original analyses (if there were any) from the DICOM file.

## 16.6 Image Controls

Place the mouse pointer in the image area and right-click.

**Table 23 Image Controls**

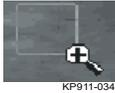
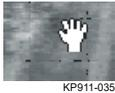
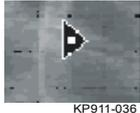
Control	Description
<b>Zoom and W-L Selection Menu (upper section)</b>	Click one of the choices to activate: Drag Zoom Drag Pan Adjust WL
<b>Drag Zoom</b>	Drag the magnifying glass over the area of the image to be enlarged and release.  KP911-034
<b>Drag Pan</b>	Click and drag the image to place it anywhere in the window.  KP911-035
<b>W-L Adjust</b>	Allows fine tuning of W-L. Move in any direction to change the W and L values.  KP911-036
<b>Zoom Control (lower section)</b>	Select zoom control settings to enlarge or reduce the image size: Fit to Window 25% 50% 100% 200% 400%

## 16.7 DE Scan

If a dual energy scan is desired of one or two vertebrae on the IVA scan, use DE Scan.

The patient must remain on the table in the same position as during the Lateral IVA scan. If the patient has moved, another Lateral IVA scan must be acquired and the DE scan taken immediately after with the patient in the same position.

1. Click **DE Scan**.
2. Click **Analysis Tools** tab.
3. Place the mouse pointer over the upper green line (at the top of the image) and drag it to the top of the desired region.

*Note: If the image is magnified, the green lines may be outside the viewing area. To see the lines, select Fit to Window.*

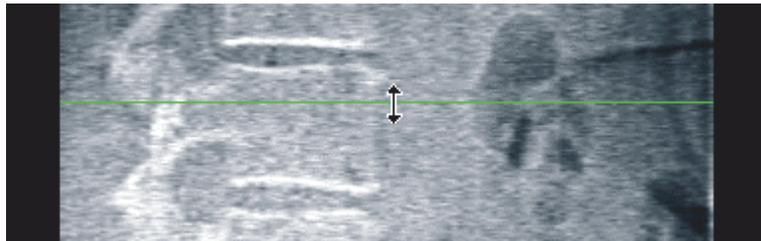

4. Place the mouse pointer over the lower green line (at the bottom of the image) and drag it to the bottom of the desired region.

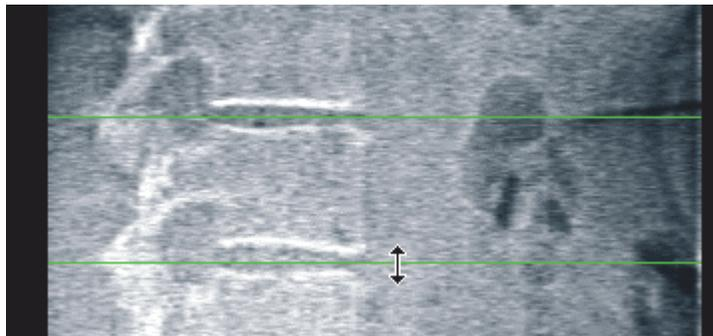

5. Click **Close**.
6. Start the new scan. The patient may breathe normally during the Dual Energy scan.

## 17 Interpreting the IVA Image

IVA images are to be interpreted by a physician or properly licensed practitioner. IVA images are not intended for general radiological diagnosis, but are intended to be used for evaluation of vertebral deformities.



The anatomy of the spine is shown in [Figure 55](#), including vertebral level labels. IVA images typically include levels T4 to L4. Following the classification scheme of Genant (see reference below), [Figure 56](#) shows examples of a typical vertebral body shape and examples of deformed vertebral shapes.

**Figure 55 The Human Spine**

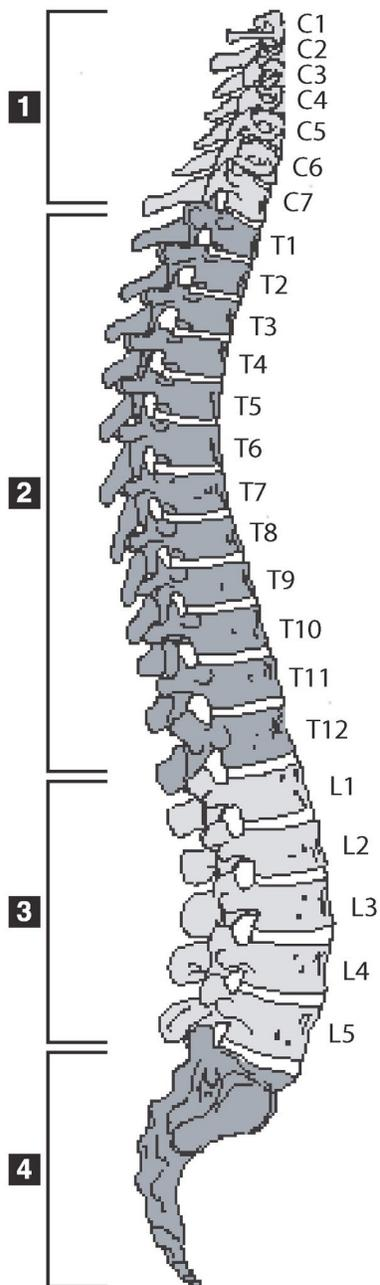

The human spine usually consists of:

1. 7 Cervical Vertebrae
2. 12 Thoracic Vertebrae
3. 5 Lumbar Vertebrae
4. Sacrum

### Figure 56 Vertebrae Deformities

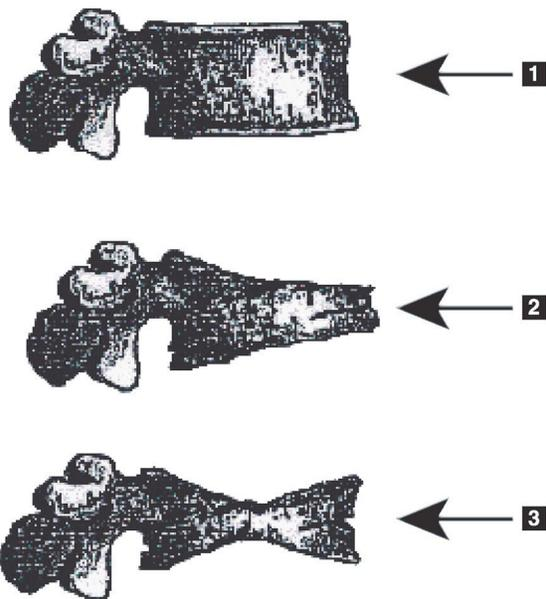

1. Typical Vertebral Body
2. Severe Wedge Deformity
3. Severe Biconcavity Deformity

Typical vertebral body shown with severely deformed vertebrae.

Adapted from Genant, H.K., C.Y. Wu, et al. (1993). "Vertebral fracture assessment using a semiquantitative technique." *J. Bone Miner Res* 8(9): 1137-48.

For detailed information regarding vertebral deformity evaluation and the utility of vertebral deformity assessment in clinical osteoporosis evaluation, see the references and organizations listed in [Section 21 Interpreting Results](#) on Page 102.

## 18 Markers

To define the shape of one or more vertebrae, markers are placed on the posterior, anterior and midpoints (Figure 57).

### Figure 57 Marker Placement

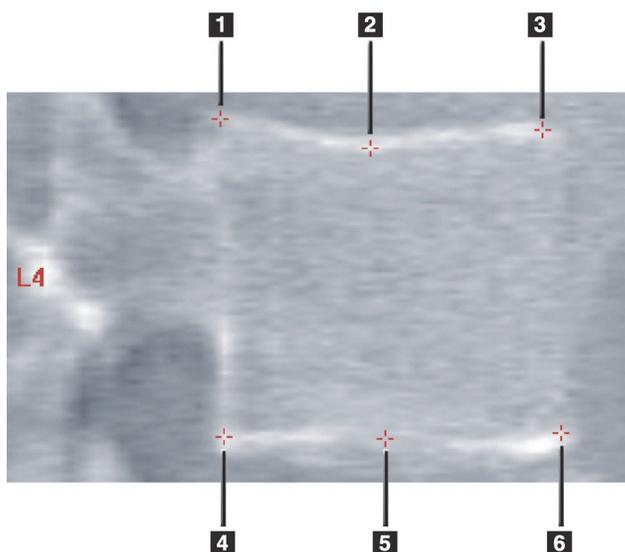

1. Superior Posterior
2. Superior Midpoint
3. Superior Anterior
4. Inferior Posterior
5. Inferior Midpoint
6. Inferior Anterior

The proper placement of these six markers is found in "The Appendix to Chapter 20: Point Placement in Vertebral Morphometric X-ray Absorptiometry" by Jacqueline A. Rea in 'The Evaluation of Osteoporosis: Dual Energy Absorptiometry and Ultrasound in Clinical Practice, Second Edition', pages 456-457.

## 18.1 Using Markers

### 18.1.1 Flipping the Image

The IVA scan image should initially display the vertebrae on the left. Before adding Markers make sure the spine is on the left. Click **Flip** if necessary.



**Note** *The image can be flipped after Markers are added.*

### 18.1.2 Adding Markers

1. Click **Markers**.
2. Right click on the image and select **Add Marker**.

**Figure 58 Adding a Marker**

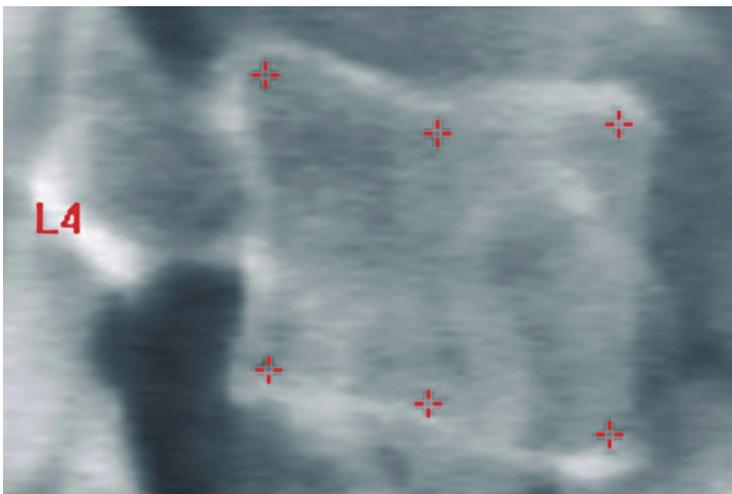

**Note** *The software attempts to determine what vertebral label based on the location of the pointer when the user clicks. After adding the first label to the image, if the assumption made by the software is wrong, change the label before adding another. As additional labels are added, if any label is wrong, change that label before adding another.*

### 18.1.3 Selecting Markers

1. Place the mouse pointer in the middle of the six markers and click

**Figure 59 Selecting a Marker**

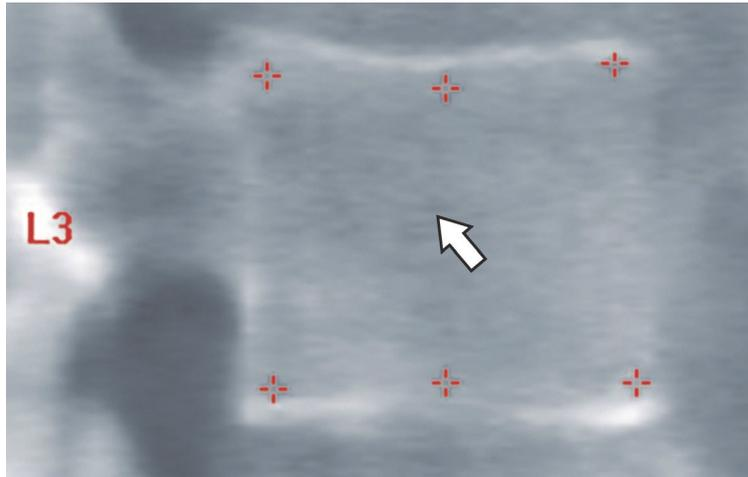

or select the marker data in the Result Block.

**Figure 60 Marker Data in the Result Block**

L3	22.6	21.1	22.9	1.01	0.93
L4	21.3	19.3	22.4	1.05	0.91

The selected markers appear yellow (red if the image is inverted). The unselected markers appear red (cyan if the image is inverted).

## 18.2 Result Block

The result box for the Lateral and the AP IVA scans must be interpreted differently because of the positions of the spine in the scan.

### 18.2.1 Result Block for Lateral IVA Scans

The Vertebral Assessment panel is displayed in the lower right corner of the window when the viewer is in Single View mode. This panel lists the results in tabular form for each vertebra analyzed in the image displaying in the image area.

There are two lines of data for each possible vertebral analysis.

- The first line contains the vertebra's label, Post, Mid, and Ant Height in mm and the percentage deformation for Wedge, Biconcave, and Crush.
- The second line contains the deformity type along with its severity. Some of this data may be blank based on which kind of analysis of the vertebra was performed. Two blank lines appear for unanalyzed vertebrae.
- The last line of data in this table shows the Standard Deviation values for each of the displayed types of data. For example, the Post Hght (mm) has a standard deviation of  $\pm 1$  mm; Wedge percent deformation has a standard deviation of  $\pm 5\%$ .

Figure 61 Result Block

Vertebral Assessment						
Label	Height(mm)			Percent Deformation		
	Post Deformity (Grade)	Mid	Ant	Wedge	Biconcave	Crush
T7	18.0	16.0	18.0	0.0%	11.1%	0.0%
T8	18.0	16.0	18.0	0.0%	11.1%	0.0%
T9	18.0	16.0	18.0	0.0%	11.1%	0.0%
T10	18.0	16.0	18.0	0.0%	11.1%	0.0%
T11	18.0	16.0	18.0	0.0%	11.1%	0.0%
T12	18.0	16.0	18.0	0.0%	11.1%	0.0%
L1	18.0	16.0	18.0	0.0%	11.1%	0.0%
L2	18.0	16.0	18.0	0.0%	11.1%	0.0%
L3	18.0	16.0	18.0	0.0%	11.1%	0.0%
L4	18.0	16.0	18.0	0.0%	11.1%	0.0%
Std Dev	1.0	1.0	1.0	5.0%	5.0%	5.0%

Table 24 Result Block Labels

Label	Description
<b>Post Hght (mm)</b>	The height of the vertebrae between the superior and inferior posterior markers in millimeters.
<b>Mid Hght (mm)</b>	The height of the vertebrae between the superior and inferior midpoint markers in millimeters.
<b>Ant Hght (mm)</b>	The height of the vertebrae between the superior and inferior anterior markers in millimeters.
<b>Wedge</b>	The distance in millimeters when the <b>Ant Hght</b> is divided by the <b>Post Hght</b> .
<b>Mid Wedge</b>	The distance in millimeters when the <b>Mid Hght</b> is divided by the <b>Post Hght</b> .

### 18.2.2 Result Block for AP IVA Scans



**Note**

*Hologic does not recommend placing Markers on the AP IVA scan.*

The Result Block for the AP IVA scan will appear the same as the above Lateral IVA scan but the labels are used differently because of the position of the spine. The **Mid Hght**, **Wedge** and **Mid Wedge** are the same but the **Post Hght** must be interpreted as the **Right Side** of the vertebrae and the **Ant Hght** must be interpreted as the **Left Side** of the vertebrae according to the following:

**Table 25 Result Block for the AP IVA Scan**

Lateral IVA Scan	AP IVA Scan
Post Hght (mm)	Right Side (mm)
Ant Hght (mm)	Left Side (mm)

The **Left Side** and **Right Side** labels will not appear in the AP IVA scan Result Block report or be printed on any reports.

## 18.3 Printing

The viewer provides two modes for printing what is viewed on the screen: Print Report and Print Image.

Printing is integrated into the standard Windows print architecture. That is, you can select the output device, number of copies, change properties, and so forth. You can also select a print preview to view what will be printed on your screen.



**Note** *If any new CADfx analyses have been placed on the image, you will have to accept the analyses before the results can be printed or viewed on the monitor screen.*

### 18.3.1 Print Report

Print Report can be used only in Single View mode.

### 18.3.2 Print Image

Print Image can be used in both Single and Multiple View modes. For additional Report types, refer to [Section 20 Reports](#) on Page 92.

# 19 Compare and Follow-up

## 19.1 Restore a Baseline or Prior Scan

If the patient's baseline or prior scan is not currently on the system, locate and restore it ([Section 23 Locate Scans](#) on Page 107 and [Section 24 Restore Scans](#) on Page 107).

## 19.2 Evaluate the Baseline or Prior Scan

Ensure that the baseline or prior scan is analyzed correctly. If it is not, re-analyze and archive it and all subsequent scans.

## 19.3 Perform the Follow-Up Scan

For the procedure to perform the follow-up scan refer to the following:

**Table 26 Follow-up Scan Procedures**

Scan	Section
AP Lumbar	<a href="#">AP Lumbar Spine Examination</a> on Page 19
Hip	<a href="#">Hip Examination</a> on Page 24
Forearm	<a href="#">Forearm Examination</a> on Page 37
Whole Body	<a href="#">Whole Body Examination</a> on Page 46
AP/Lateral	<a href="#">Supine AP/Lateral Spine BMD Examination (Horizon A)</a> on Page 60
Decubitus Lateral	<a href="#">Decubitus Lateral Spine BMD Examination</a> on Page 66

Then, from the Exit Exam screen, click **Analyze Scan**.

## 19.4 Analyze the Follow-up Scan Using Compare Analysis

1. Auto compare to the baseline, or prior, scan depending upon analysis configuration.
2. Optional. Use the Legacy Image Style option(see [Use the Legacy Image Style Option](#) on Page 92) if previous/baseline scan was acquired on a legacy Hologic system.
3. Click **Results**.
4. Click **Close**.
5. If necessary, use the Analysis Step Buttons and Toolbox tools to compare the follow-up scan. Match the analysis of the follow-up scan to the baseline or prior scan.



**Note** Use *Compare Analysis* for best rate of change results.

### 19.5 Use the Legacy Image Style Option

If a previous or baseline scan was acquired on a legacy Hologic system, use the Legacy Image Style option to display and analyze a Horizon spine or hip scan image in a matching legacy image style.

To use the Legacy Image Style option:

1. Auto compare to the baseline, or prior, scan depending upon analysis configuration.
2. Note the **Image Style** listed for the comparison scan.
3. Click the **Image Style** drop-down menu beneath the Horizon scan image, and select the appropriate matching image style:
  - **Horizon** - Display spine or hip image using Horizon image style. (Default)
  - **Discovery** - Display spine or hip image using Discovery image style.
  - **Classic** - Display spine or hip image using classic (Delphi instrument) image style.
  - **Legacy** - Display spine or hip image using legacy (4500 instrument) image style.
4. Click **Results**.
5. Click **Close**.
6. If necessary, use the Analysis Step Buttons and Toolbox tools to compare the follow-up scan. Match the analysis of the follow-up scan to the baseline or prior scan.

### 19.6 Generate the Rate of Change Report

1. Click **Report** in the **Exit Analysis** window.



**Note** *If the regions for prior scans do not exactly match but partially match the current scan, a report is generated for only those regions that match.*

2. Check the **Rate of Change** checkbox.
3. Click **Print**.

## 20 Reports

1. Click **Report** in the main window.
2. Click the name of the patient, then click **Next >>**.



3. Click the desired scans, then click **Next >>**. For creating dual hip scan pairs (Section 20.3.2 *Create Hip Pairs for Dual Hip Rate of Change Reports* on Page 95).
4. For comments on the printed report, click **Edit comment...** (Figure 62).
5. Select one of the following:
  - Choose the report type by clicking its box. (Section 66 *Create and Send a DICOM Report* on Page 100).
  - Click **DICOM / IVA report**. (Section 66 *Create and Send a DICOM Report* on Page 100).
  - Click **Generate DxReport**. See *DxReport User Guide* (MAN-02331). You can configure the DxReport from the Report Tab under the System Configuration screen.
6. Click **Print**.

## 20.1 Report Information Blocks

Reports contain *blocks* of information which vary slightly depending upon the type of report you choose. Refer to Figure 62 and the following text for an explanation of report blocks.

Figure 62 Report Blocks

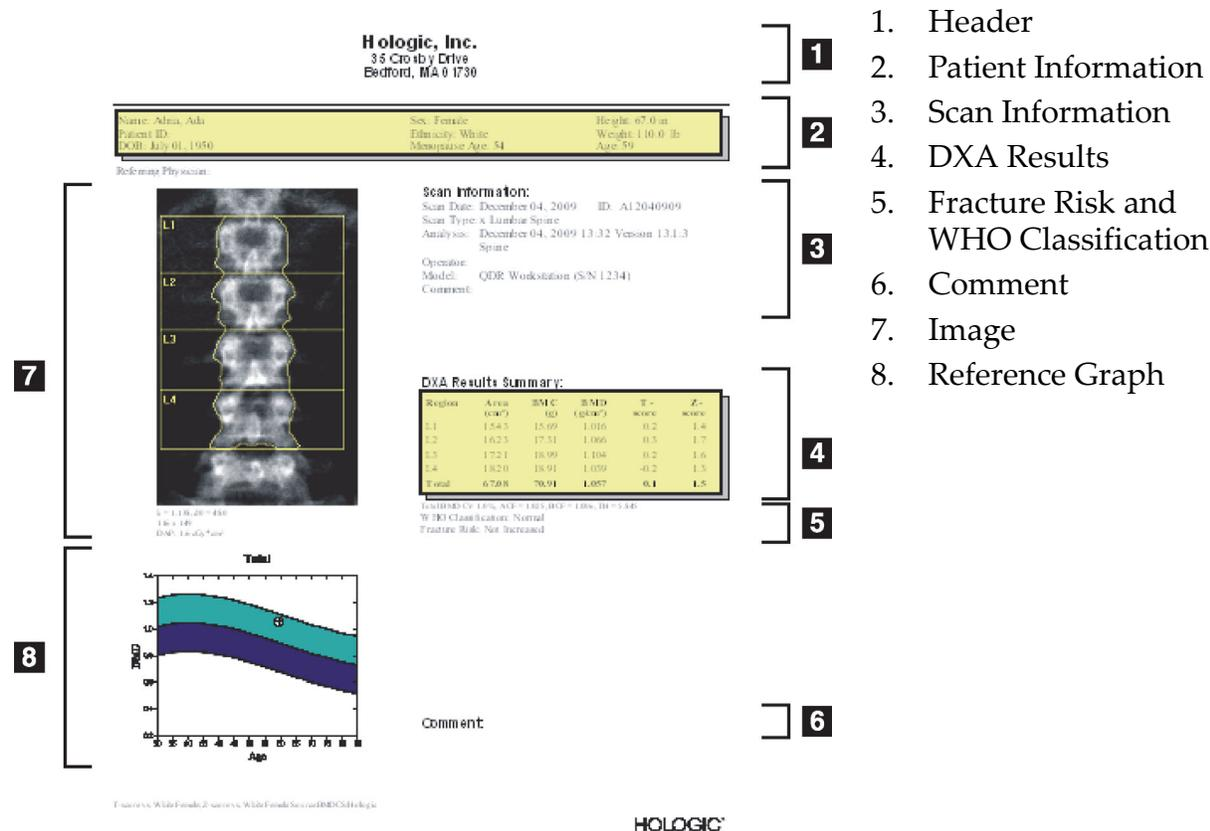

### 20.2 Edit Comments

1. In the *Print* window, click **Edit comment...**
  - To select from the list of predefined comments, click the down arrow.
  - To enter a new comment, click in the *Comment* text box.



**Note** *New comments are not added to the list of predefined comments.*

2. Click **Update**.

### 20.3 Rate of Change Report

The Rate of Change Report tracks changes in results over time and includes:

- Detailed patient and scan information
- Scan date, patient age, BMD, and T-score results for each visit
- Changes in results provided in percent (%) and/or as an absolute difference (gm/cm<sup>2</sup>) vs. Baseline and previous scans
- Scan image with ROI and bone map outline for current scan
- BMD vs. Age reference curve graph for each baseline and subsequent scans
- 10-year Fracture Risk (Hip scans only)
- Body Composition Rate of Change Results (Whole Body scans only)

For more information, see [Section 21 Interpreting Results](#) on Page 102.

#### 20.3.1 Remove Asterisks (\*) and Pound Signs (#) from Reports

Reports may include asterisks (\*) and a pound signs (#) to indicate that scan types and analysis methods do not match. To prevent asterisks (\*) and pound signs (#) from appearing in reports:

1. Click **System Configuration > Report tab**. The General tab is displayed.
2. Select **Rate of Change**.
3. Click the **Configure** button. The Configure Rate of Change dialog box is displayed.
4. Click the **Results Block tab**.
5. Uncheck **Indicate Different Scan Types or Analysis Methods**.
6. Click **OK**, then **OK** again.

### 20.3.2 Create Hip Pairs for Dual Hip Rate of Change Reports

Dual Hip Rate of Change report provides information about result changes in hip “pairs”. A *hip pair* includes a right hip scan and a left hip scan performed within 14 days of each other.

1. Access the patient scan list as you would for any report ([Section 20 Reports](#) on Page 92).
2. Select a left and right scan—one scan is the most recent. The Match Pairs of Scans dialog box is displayed.
3. Select a right hip scan from the left list box.
4. Select a left hip scan from the right list box. The down arrow is enabled.
5. Select the hip pair from the Dual Hip Pairs list.
6. Click OK.

## 20.4 Body Composition Reports

APEX software can display the DXA measures along with a representative color image mapping of “fat” and “lean” tissue ([Figure 63](#)).

A Rate-of-Change report can also be generated to display the trend of serial DXA Body Composition measurements over time ([Figure 64](#)).



**Note**      *The images on these reports should not be used for diagnosis.*

### 20.4.1 BCA Results

The report blocks and graphs for BCA results ([Figure 63](#)) are listed in the following tables. For descriptions of images, see [Section 20.6 DICOM Report](#) on Page 100.

Figure 63 Advanced Body Composition Report

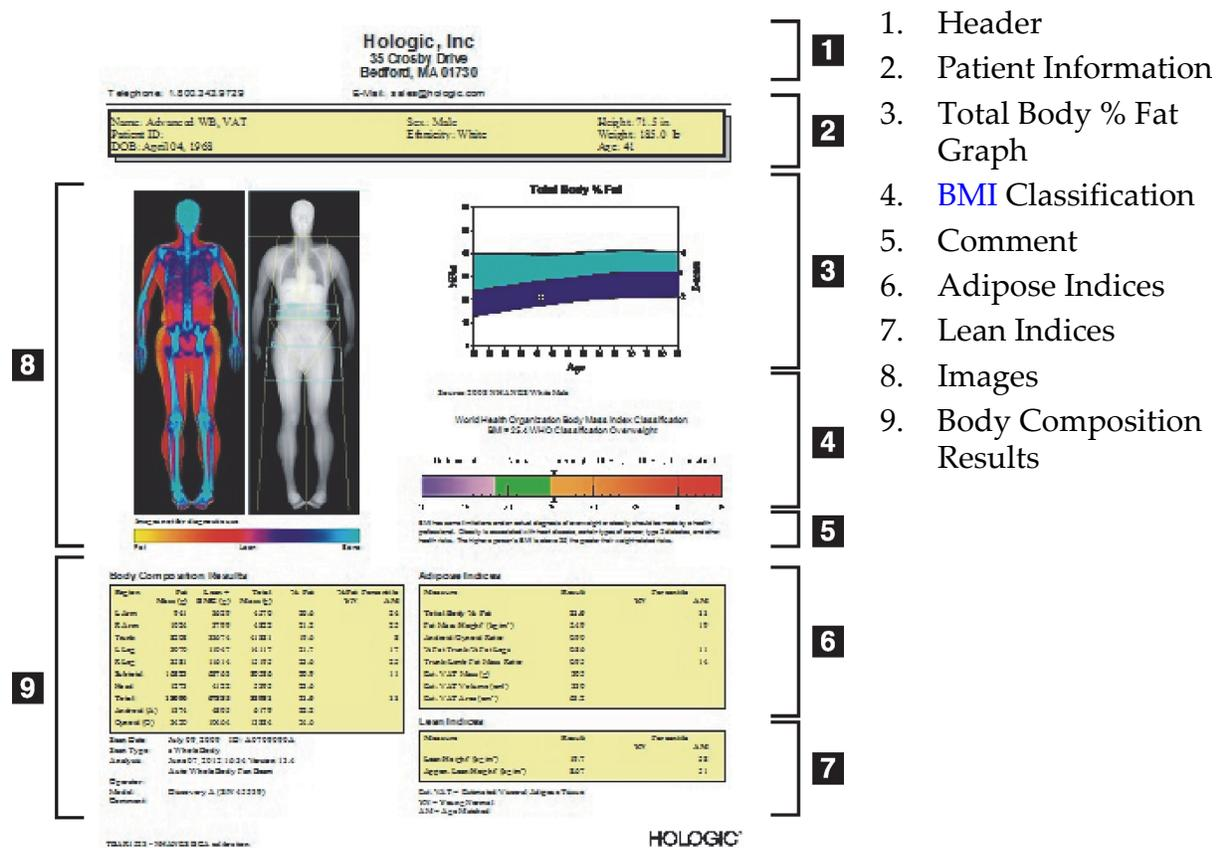

Table 27 Advanced Body Composition Report Fields

Report Block	Description
Body Composition Results	Results for the standard SubRegions (arms, trunk, legs and head), subtotal (excludes head), total (includes head) and Android and Gynoid regions.
Adipose Indices	Results and indices for the subject's adipose tissues.
Lean Indices	Results and indices for the subject's lean mass tissues.

Table 28 Advanced Body Composition Graph Fields

Graph	Description
Age vs. Total Body % Fat Graph <sup>1</sup>	Graph of the subject's age vs. Total Body % fat.
WHO BMI Classification	Scalar representation of the subject's WHO Body Mass Index Classification.

1 User Configurable.

### 20.4.2 BCA Rate of Change Results

The Advanced Body Composition™ report blocks and graphs for BCA Rate of Change results (Figure 64) are listed in the following tables.

Figure 64 Advanced Body Composition Rate of Change Report

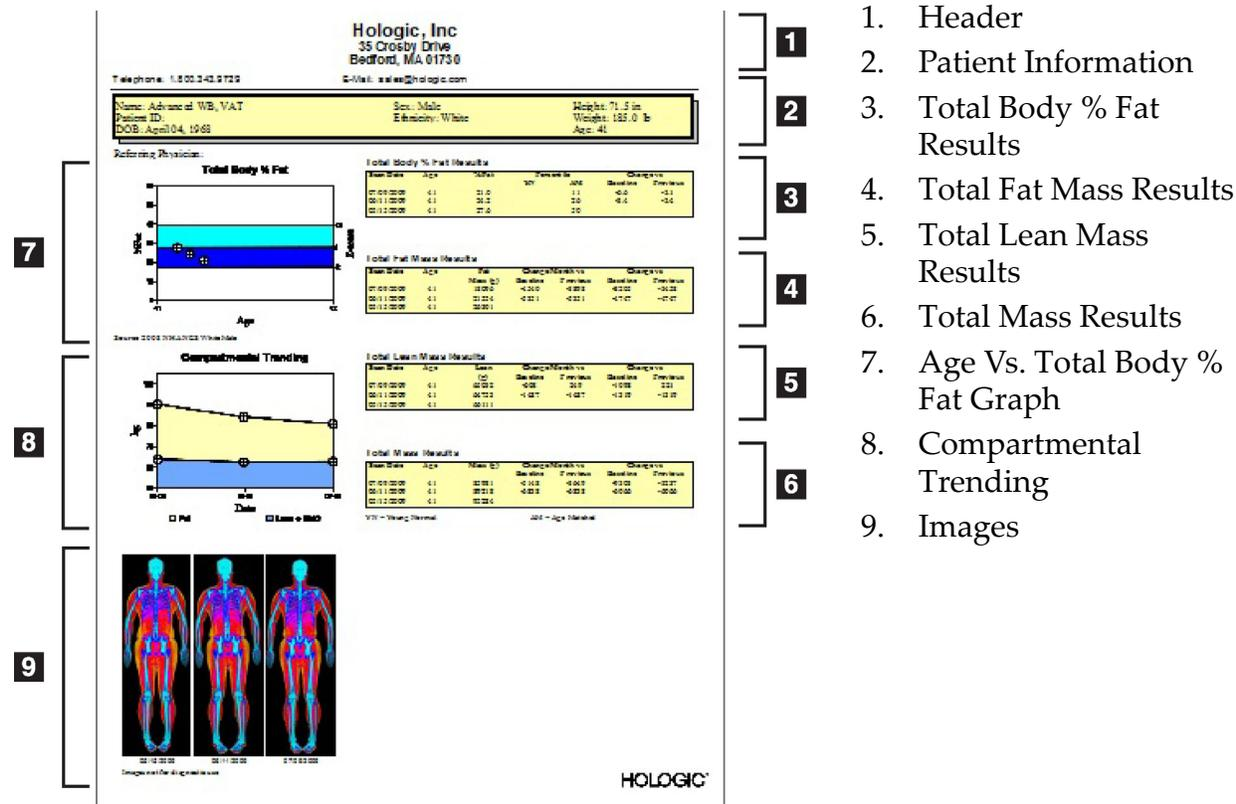

Table 29 Advanced Body Composition Rate of Change Report Fields

Report Block	Description
Total Body % Fat Results <sup>1</sup>	Results, indices and comparison data for the subject's % fat.
Total Fat Mass Results*	Results, indices and comparison data for the subject's total fat.
Total Lean Mass Results*	Results, indices and comparison data for the subject's lean plus BMC mass.
Total Mass Results*	Results, indices and comparison data for the subject's total mass.

1 User Configurable

**Table 30 Advanced Body Composition Rate of Change Graph Fields**

Graph	Description
Age vs. Total Body % Fat Graph <sup>1</sup>	Graph of the subject's age vs. Total Body % fat.
Compartmental Trending*	Graph of the changes in Total Body Fat Mass and Total Body Lean Mass

1 User Configurable

### 20.4.3 Body Composition Reports and Reference Database Comparisons

In 2008 NHANES released a population-based DXA whole body dataset acquired on Hologic scanners. Selected DXA measures can be compared to gender, ethnicity, and age-specific reference databases developed from the NHANES whole body dataset released in 2008.<sup>2</sup>

The software can also display the DXA measures along with a representative color image mapping of "fat" and "lean" tissue (Figure 63). The color image displays the relative amounts of fat and lean tissue in the DXA image, with yellow regions representing regions with higher %Fat and orange and red regions indicating progressively lower %Fat. Bone containing regions are indicated in blue. Beside the color image is an image that is brighter in regions of greater tissue thickness and darker in thinner tissue. It is used to display the region of interest lines placed by the operator during analysis. Beneath the images the phrase "Image not for diagnostic use" appears, informing the user that the image should not be used for diagnosis. The color image displays the relative distribution of fat and lean tissue in the image and does not contain diagnostic or quantitative information.

A reference curve is generated for Total Body % Fat versus Age that is matched to the patient's gender and ethnicity. The graph provides a graphical representation of the patient's measurement relative to age-matched peers. The midline of the graph represents the median reference value and the upper and lower shaded regions define the 95% confidence interval for the plot. Note that the upper and lower shaded regions of the reference curve may not be exactly equal in size; this is an indication that the underlying reference data are not normally distributed. An algorithm that adjusts for skewness in the underlying reference data has been implemented to provide accurate T-scores, Z-scores, and percentiles.

---

2. T.L. Kelly, K.E. Wilson and S.B. Heymsfield, "Dual energy X-ray absorptiometry body composition reference values from NHANES," PLoS One, 4 (2009), e7038.

A Body Mass Index (BMI) scale appears on the report to display the patient's calculated BMI based upon the patient's height and weight as entered by the operator. Proper height and weight should always be verified before interpreting the results displayed in the BMI scale. Above the scale the WHO BMI classification appears along with an explanation of the health risks associated with a high BMI. Beneath the graph a paragraph appears that summarizes the U.S. Surgeon General's Health Consequences for overweight and obesity

([http://www.surgeongeneral.gov/topics/obesity/calltoaction/fact\\_advice.htm](http://www.surgeongeneral.gov/topics/obesity/calltoaction/fact_advice.htm)). For more information, see <http://www.surgeongeneral.gov/topics/obesity/calltoaction/CalltoAction.pdf>.

Patient results can be compared to values in the Hologic Whole Body DXA Reference Database both graphically and quantitatively (Figure 63). The graphical plot displays the reference values along with the subject's measured DXA value. In adults, the quantitative comparison provides a Z-score or an Age-matched (AM) Percentile value and a T-score or a Young Normal Percentile value (YN). For subjects less than 20, only a Z-score or an Age-matched (AM) Percentile value is provided. A simple mathematical transformation is used to convert Z-scores and T-scores to Age-matched and Young Normal Percentile values, respectively, depending upon whether the user configures the software to display Z- and T-scores (standard deviation scores) or percentiles.

A Rate-of-Change report can also be generated to display the trend of serial DXA Body Composition measurements over time (Figure 64). The Total Body %Fat curve at the top left of the report displays the trend of the Total Body %Fat results over time. These measurements are displayed on an age, gender, and ethnicity-matched reference curve from the Hologic Whole Body DXA Reference Database.

Immediately below the Total Body %Fat curve is another plot labeled "Compartmental Trending." This plot provides a graphical display of the changes in Total Body Fat Mass (yellow shaded region) and Total Body Lean Mass (blue shaded region). Total Mass, i.e. the sum of yellow Fat Mass region plus the blue Lean Mass region, is indicated by the uppermost line of the plot.

## 20.5 Pediatric Reports

**Pediatric Reports** displays a graph of the subject's measurement plotted on a gender and ethnicity-matched reference curve. Below the plot are corresponding results based upon the available measures selected in the system configuration for this report. Each DXA measure is plotted on a percentile scale and the Z-score and centile for the subject's measurement relative to gender and ethnicity-matched peers is provided at the far right of the scale. Reference data from Hologic, the Bone Mineral Density in Childhood Study, and NHANES is used for Z-scores and percentiles.

Figure 65 Pediatric Spine Report

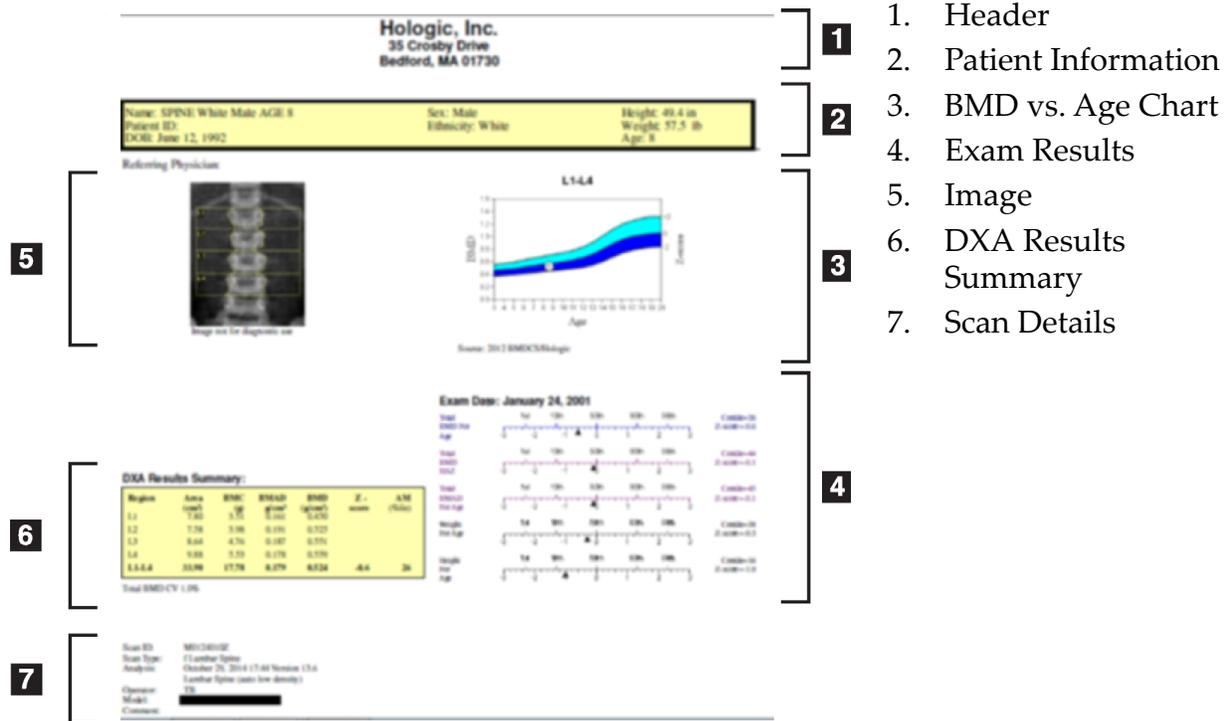

## 20.6 DICOM Report

Figure 66 Create and Send a DICOM Report

### Select a DICOM BMD Report Type

1. Select the desired scans.
2. Select the **DICOM BMD** report type.

### View Scan Details and Enter Patient Biography Fields

1. Select the scan on the **DICOM Report** window.
2. Click **Scan Details**.
3. Click the **Details** tab.
4. Edits are allowed on the following fields:
  - Accession Number - 16 characters maximum
  - Study Instance UID - 28 characters maximum
  - HL7 Field 1 - 64 characters maximum
  - HL7 Field 2 - 64 characters maximum
  - HL7 Field 3 - 64 characters maximum



**Note**

*The HL7 fields are user definable and provide additional information.*



- Operator - 5 characters maximum
  - Height - 5 characters maximum
  - Weight - 5 characters maximum
  - Scan Comment - 100 characters maximum
5. Click the **Identification** tab to view the scan information.
  6. Click **OK** to save edits; click **Cancel** to close without saving.

### 20.6.1 Enter the Accession Number and User Defined Entries

1. Select a scan on the *DICOM Report window*.
2. Click **Save As** or **Send**.
3. If the selected scan does not have an accession number enter one, then press **Enter** or **OK**.
4. Click **Cancel** if the accession number is unknown or will be entered later.
5. If prompted to add additional user defined entries, enter and click **OK** for each dialog box.

### 20.6.2 Preview a DICOM Report

Click the **Preview** button to view the *DICOM* report before you save or send the report.

### 20.6.3 Print a DICOM Report

Click the **Print** button on the *DICOM Preview* screen to print the *DICOM* report to the local default printer.

### 20.6.4 Save a DICOM Report

Click the **Save As** button to save a *DICOM* report as a file to your desired location.

### 20.6.5 Send a DICOM Report

1. Select the scans on the *DICOM Report window*.  
Assign the same Accession Number to all scans associated with this patient's visit.
2. Click **Send**.  
For each selected scan, a *DICOM* report is generated, placed in the queue, and sent in the order the report was placed in the queue.  
To view send status, see [Section 20.6.7 View the Queue](#) on Page 101.

### 20.6.6 Sort the Scan List

Click any heading to sort the scan list by ascending or descending order.

### 20.6.7 View the Queue

Click the **View Queue** button to view scans in the queue waiting to be sent.

View a History of Sent Reports

Click the **View Log** button on the *View Queue* dialog box.

Update the status of DICOM Reports in the Queue

Click the **Refresh** button on the *View Queue* dialog box.

Delete a DICOM Report from the Queue

Click the **Delete** button on the *View Queue* dialog box.

#### 20.6.8 Close a DICOM Report

Click the **Cancel** button or the <<**Back** button on the *DICOM Report window*.

## 20.7 DxReport

### 20.7.1 Create a DxReport

1. Select Interpreting Physician
2. Check or uncheck Include rate of Change
3. Click Generate DxReport

A Word report will be generated in accordance with the configuration settings see *DxReport Users Guide* MAN-02331.



**Caution** *A qualified medical professional must review each patient report that DxReport generates before the report is released.*

## 21 Interpreting Results

### Websites:

- [www.iscd.org](http://www.iscd.org) - Particularly, the ISCD Official Positions
- [www.nof.org](http://www.nof.org) - Particularly, the NOF Physician's Guide
- [www.iofbonehealth.org](http://www.iofbonehealth.org) - Particularly, Health Professionals, including Educational Tools and Slide kits.
- <http://www.aace.com> - American Association of Clinical Endocrinologists

### Publications:

- U.S. Department of Health and Human Services. Bone Health and Osteoporosis: A Report of the Surgeon General. Rockville, MD: U.S. Department of Health and Human Services, Office of the Surgeon General, 2004.
- Kanis, JA on behalf of the World Health Organization Scientific Group (2007), Assessment of osteoporosis at the primary health-

care level. Technical Report. World Health Organization Collaborating Centre for Metabolic Bone Diseases, University of Sheffield, UK. 2007:Printed by the University of Sheffield.

- The Evaluation of Osteoporosis: Dual Energy Absorptiometry and Ultrasound in Clinical Practice, Second Edition; Blake, G. M., Walgner, H. W., Fogelman, I., © Martin Duritz Ltd 1999
- Merrill's Atlas of Radiographic Positions and Radiologic Procedures; P. W. Ballinger and Ed Frank, Eds. (Mosby, New York) 1999
- Genant HK, Jergas M, van Kuijk C (Eds.): Vertebral Fracture in Osteoporosis. San Francisco, CA, University of California Osteoporosis Research Group, 1995
- Genant, H. K., C. Y. Wu, et al. (1993). "Vertebral fracture assessment using a semiquantitative technique." J Bone Miner Res 8(9): 1137-48.
- Levitzky YS, Cupples LA, Murabito JM, Kannel WB, Kiel DP, Wilson PW, Wolf PA, O'Donnell CJ 2008 Prediction of intermittent claudication, ischemic stroke, and other cardiovascular disease by detection of abdominal aortic calcific deposits by plain lumbar radiographs. Am J Cardiol 101(3):326-31.
- Oei HH, Vliegenthart R, Hak AE, Iglesias del Sol A, Hofman A, Oudkerk M, Witteman JC 2002 The association between coronary calcification assessed by electron beam computed tomography and measures of extracoronary atherosclerosis: the Rotterdam Coronary Calcification Study. J Am Coll Cardiol 39(11):1745-51.
- Schousboe JT, Taylor BC, Kiel DP, Ensrud KE, Wilson KE, McCloskey EV 2008 Abdominal aortic calcification detected on lateral spine images from a bone densitometer predicts incident myocardial infarction or stroke in older women. J Bone Miner Res 23(3):409-16.
- Schousboe JT, Vokes T, Broy SB, Ferrar L, McKiernan F, Roux C, Binkley N 2008 Vertebral Fracture Assessment: The 2007 ISCD Official Positions. J Clin Densitom 11(1):92-108.
- Schousboe JT, Wilson KE, Kiel DP 2006 Detection of abdominal aortic calcification with lateral spine imaging using DXA. J Clin Densitom 9(3):302-8.

### 21.0.1 About FRAX

Fracture Risk Assessment as calculated by FRAX has specific age, weight, and height limits. The age range is between 40 years and 90 years. If you enter an age between 20 and 40 years, FRAX will calculate the probability of fracture at the age of 40 years. If you enter an age above 90 years, FRAX will calculate the probability of fracture at the age of 90 years. The weight range is between 25 kg (55 lbs) and 125 kg (276 lbs); the height range is between 100 cm (39 in) and 220 cm (86 in). If you enter a weight or height outside of those ranges, FRAX will calculate the probability of fracture at these limits.

BMI is calculated by the software using patient's weight and height data.

Femoral Neck BMD value is obtained from the patient's most recent Hip scan analysis.

### 21.0.2 FRAX Limiting Criteria

NOF/ISCD recommends the use of the FRAX limiting criteria for US configurations. However, you can configure FRAX to remove the limiting criteria. For more information see [Configuring FRAX](#) on Page 105.

Choose **Yes** or **No** for the FRAX limiting criteria as follows.

#### Previous hip or vertebral fracture

Choose **Yes** if the patient had a prior hip or vertebral fracture (clinical or morphometric). If yes, FRAX will not be calculated.

#### Treatment for osteoporosis

Choose **Yes** if the patient is currently being treated for osteoporosis. If yes, FRAX will not be calculated.

Examples of “untreated” patients include:

- No ET/HT or SERM for the past one year
- No calcitonin for the past one year
- No PTH for the past one year
- No denosumab for the past one year
- No bisphosphonate for the past two years (unless it is an oral taken for less than 2 months)



**Note**      *Calcium and vitamin D do NOT constitute “treatment” in this context*

#### Premenopausal woman

Choose **Yes** if the woman had menses in the last year or is breast feeding. If yes, FRAX will not be calculated.

## Configuring FRAX

To remove the FRAX limiting criteria:

1. From the **Utilities** menu select **System Configuration > Report tab**.
2. Ensure the **General** tab is selected and in the **Ten Year Fracture Risk** section click **Configure**.
3. In the **Display Settings** section, select **Use IOF configurations**,
4. Click **OK**.

### 21.0.3 About 10-year Fracture Risk - All Countries

The following was adapted from the WHO Collaborating Centre for Metabolic Bone Diseases, University of Sheffield, UK website, January 2008, and used with permission.

The FRAX tool has been developed by WHO to evaluate fracture risk of patients. It is based on individual patient models that integrate the risks associated with clinical risk factors as well as bone mineral density (BMD) at the femoral neck.

The FRAX models have been developed from studying population-based cohorts from Europe, North America, Asia and Australia.

The FRAX algorithms give the 10-year probability of fracture. The output is a 10-year probability of hip fracture and the 10-year probability of a major osteoporotic fracture (clinical spine, forearm, hip or shoulder fracture).

For answers to frequently asked questions about FRAX, see [Section 35 FRAX FAQs](#) on Page 141.

21.0.4 FRAX Risk Factors

Refer to [Table 31](#) to determine appropriate response for FRAX risk factors.

**Table 31 FRAX Risk Factors**

Risk Factor	Response
Country Code	<i>Select the desired Country (Ethnicity) by clicking the down arrow and choosing from the list.</i>
Previous fracture	<p>Check <b>Yes</b> if the patient sustained a broken bone after age 40 excluding fractures of the skull, hands and feet. A previous fracture denotes more accurately a previous fracture in adult life occurring spontaneously, or a fracture arising from trauma which, in a healthy individual, would not have resulted in a fracture.</p> <p><i>Note: A fracture detected as a radiographic observation alone, i.e. seen with IVA, counts as a previous fracture</i></p>
Parental fractured hip	Check <b>Yes</b> for a history of hip fracture in the patient's mother or father.
Current smoking	Check <b>Yes</b> if the patient currently smokes tobacco.
Glucocorticoids	Check <b>Yes</b> if the patient is exposed to oral glucocorticoids or has been exposed to oral glucocorticoids for more than 3 months at a dose of prednisolone of 5mg daily or more (or equivalent doses of other glucocorticoids).
Rheumatoid arthritis (RA)	Check <b>Yes</b> if the patient has a confirmed diagnosis of rheumatoid arthritis by a physician, (i.e., not a self-diagnosis of RA).
Secondary osteoporosis	Check <b>Yes</b> if the patient has a disorder strongly associated with osteoporosis. These include type I (insulin dependent) diabetes, osteogenesis imperfecta in adults, untreated long-standing hyperthyroidism, hypogonadism or premature menopause (<45 years), chronic malnutrition, or malabsorption and chronic liver disease.
Alcohol 3 or more units per day	Check <b>Yes</b> if the patient takes 3 or more units of alcohol daily. A unit of alcohol varies slightly in different countries from 8-10g of alcohol. This is equivalent to a standard glass of beer (285ml), a single measure of spirits (30ml), a medium-sized glass of wine (120ml), or 1 measure of an aperitif (60ml).

Whenever there is uncertainty by the patient as to an answer, mark it as **No**.

### 21.0.5 References

The development of the models for fracture risk assessment has been based on a program of work undertaken at the WHO Collaborating Centre for Metabolic Bone Diseases at Sheffield University. Further details are provided in the QDR Reference Manual. These include papers on the modeling approach, meta-analyses to evaluate bone mineral density and other risk factors, and recent reviews.

## 22 Archive Scans

1. Click **Archive Scans** in the main window.
2. Select the scans to be archived.
3. Click **Archive Scans**. The **Transfer Results** window is displayed.
4. Click **OK**.

Hologic recommends an immediate second archive of the same scans to another cartridge or disk. Creating the second archive protects against scan loss in case of damage to the first cartridge or disk.

## 23 Locate Scans

Locate scans archived to a PACS server using Query/Retrieve Scans. See [Section 26 Query/Retrieve Scans](#) on Page 108.

1. Click **Locate Scans** in the main window.
2. Click the patient's name, then click **Locate Scans**.
3. Select scans from the Primary Archive tab.



**Note** *If you cannot restore scans from the Primary Archive media screen, contact your Hologic service representative before using the Secondary Archive media.*

4. Place the cartridge or disk with the correct Label into the disk drive.
5. Click **Restore Scans**.
6. Click **OK**.

## 24 Restore Scans

1. Click the **Archive** dropdown menu in the main window, then select **Restore Scans**.
2. Select the scans to be restored and click **Restore Scans**.
3. Click **OK**.

## 25 Copy Scans

1. Click the **Archive** dropdown menu in the main window, then select **Copy Scans**.
2. Select the scans to be copied to the specified location:
3. Click **Copy Scans**.
4. Click **OK**.

## 26 Query/Retrieve Scans

Use Query/Retrieve to locate and retrieve scans from a configured PACS server into the QDR system.

1. Select **Query/Retrieve** from the **Archive** drop-down menu on the main screen.
2. Complete **Query** parameters as desired.
3. Click **Optional Filters** to add study level filters to the query or go to Step 5.
4. Complete **Study level filters** as desired.
5. If more than one active location is configured, select archive location (**Destination**).
6. Click **Query**.
7. In the **Retrieve** section, select the study or studies to retrieve.
8. Click **Retrieve**.

## 27 Perform System Backup

Perform a System Back to copy the system database to removable media or to a directory on a computer network.

1. Click **System Backup** in the main window.
2. Enter the backup location (or accept the default location).
3. Accept the default backup filename, or enter a different filename (not recommended).



**Caution** *Changing the backup filename makes restoring the correct file difficult.*

4. Click **OK**.



## 28 Clean the System

### 28.1 Clean the QDR and Computer Components

1. Turn off power at the main breaker.
2. Use a soft, damp cloth to wipe surfaces. If necessary, use a mild detergent to remove dirt or debris.
3. Turn on power at the main breaker.

### 28.2 Clean the Table Pad

Use a simple solution of neutral soap and lukewarm water. Let dry thoroughly before scanning.



**Note**      *Do not remove the cover from the table pad to clean or disinfect.*

If cleaning does not produce satisfactory results, contact your Hologic representative to order a replacement table pad.

### 28.3 Disinfect the Table Pad

1. Use a phenolic, or quaternary type disinfectant in the concentration recommended by the manufacturer.



**Note**      *Disinfectants applied at full concentration, or in highly concentrated solutions may damage the fabric.*

*Idophor (i.e., iodine bearing) type disinfectants may result in staining if these are not treated with a diluted (10 to 1) bleach solution within 20 minutes of application or spillage.*

2. Let dry thoroughly before scanning.

### 28.4 Clean Accidental Spills

Discourage the presence of liquids in the vicinity of the Horizon system.

1. Wipe the spill immediately with a slightly dampened sponge. If the spill penetrates the system's interior, turn off power at the main breaker immediately.



**Note**      *Contact your Hologic service representative if you need assistance.*

2. Let the table pad dry thoroughly before scanning.



**Note** *Moisture on the table pad can distort X-ray transmission and produce erroneous analysis results.*

3. Turn on power at the main breaker when the unit is thoroughly dry.

## 29 Emergency Procedures

### 29.1 Power Failure

Turn off all equipment. When the power returns, it may be unstable. Wait a few minutes before turning on the equipment.

#### 29.1.1 Shutting Down

1. If the Horizon was operating when the power failure occurred, assist the patient from the table.
2. Turn off the computer.
3. Turn off the circuit breaker ([Figure 67](#)).

**Figure 67 Circuit Breaker and Indicator**

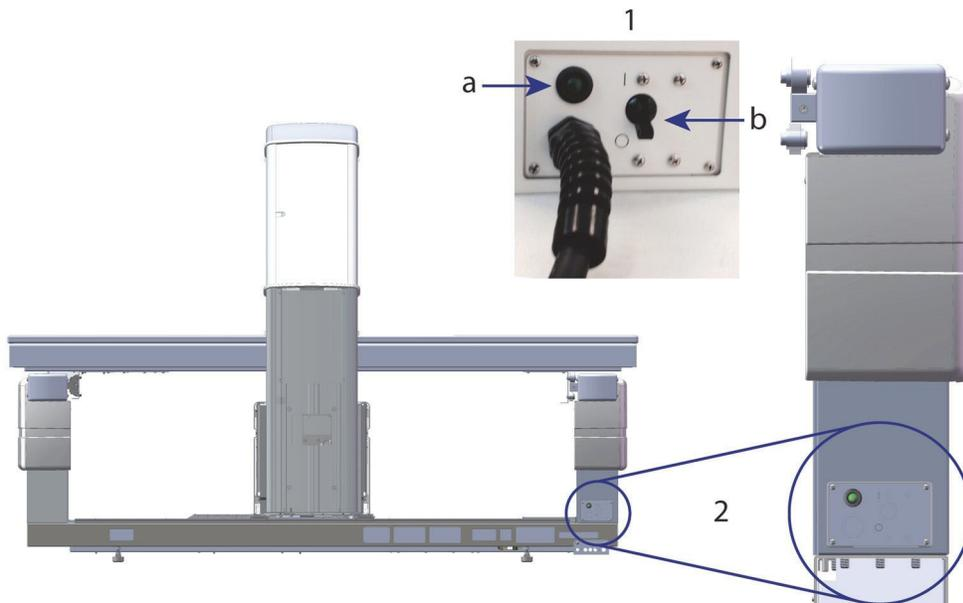

#### Horizon W Rear View

1. Circuit Breaker
  - a. Indicator
  - b. Switch
2. Circuit Breaker Location

After power is restored

1. *Wait a few minutes for power to stabilize, then turn on the* circuit breaker. The green indicator goes on.
2. Perform System Startup and Shutdown (*System Startup* on Page 9 and *System Shutdown* on Page 9).

## 29.2 Failure During Operation

1. On the Control Panel, press the red Emergency Stop Button. The table and C-arm immediately stop moving, and the X-rays and laser turn off.
2. Assist the patient off the table.
3. Turn off the circuit breaker (*Figure 67*).
4. Disconnect the power cord from the AC outlet (if possible).
5. Call your Hologic service representative.

## 29.3 Loss of Power

If the circuit breaker (*Figure 67*) has been turned off (not due to equipment failure), or the system has been unplugged from the wall outlet, restore power as follows:

1. If necessary, place the power cord into the AC outlet.
2. Turn on the circuit breaker. The green indicator goes on.
3. Perform System Startup (*Section 2.1 System Startup* on Page 9).
4. If the system does not turn on, call your Hologic service representative.

# 30 Dose Area Product Meter

The Dose Area Product (DAP) Meter measures the amount of radiation a patient receives during an examination. The measurement is displayed when the examination is exited.

## 30.1 Turning the DAP Meter On and Off

1. Click **Utilities** in the main window Menu bar.
2. Click **System Configuration** in the drop-down list.
3. Select the System Tab and place a checkmark in the **Report Dose Area Product** box.
4. Click **OK**.

# 31 Utilities

Use Utilities to find, move, store, and edit patient biographies, patient scans, patient data, and system information. Click **Utilities** in the main window Menu Bar to access Utilities. Click **Help** within each utility for more information about a specific utility.

## 31.1 System Configuration

Use to change the configuration settings in functional areas of the system. Click the tab for the function desired.

## 31.2 Usage

Use to display and print billing information for leased systems. Click **Usage**.

## 31.3 Database Tools

Use to move patient, reference, and QC data to and from other databases.

### 31.3.1 Patient Management

Use to erase patient and scan data. You must erase all scans listed for a patient before you can erase the patient. Also use Patient Management to select a new baseline scan.

### 31.3.2 Export

Use to move data into a new or existing database on another system. Click **Export** to export database files in Microsoft Access database (.mdb) or Comma Separated Values (.csv) file format. Scan images included with a (.csv) database export are exported in bitmap format.

### 31.3.3 Import

Use to move data from another system into Horizon. Click **Import**.

### 31.3.4 Reconcile

Compares the system database with the scan files in the system directory and automatically corrects discrepancies.

### 31.3.5 Patient Callback

Provides a list of patients based upon selected Last Exam Date and T-score values. Click **Callback List**.

### 31.3.6 Auto Baseline Utility

Sets the baseline scan of all restored scans (patients and scan types) to the oldest scan.

## 31.4 Scan File Look

Lists records in the scan files. Click **Scan File Look**.

## 31.5 Scan File Plot

Displays a plot of records in the scan files. Click **Scan File Plot**.

## 31.6 Emergency Motion

Use only when directed to do so by an authorized Hologic representative.

## 31.7 AP Reposition

Use only when directed to do so by an authorized Hologic representative.

## 31.8 Factory Utilities

Hologic use only.

## 31.9 Service Utilities

Only used by an authorized Hologic representative.

## 31.10 Reference Curve

Use to set up and manage custom reference curves.

### 31.10.1 Editor

Functions available under Editor include: **New, Edit, Copy, View and Delete**. Click the desired function.

### 31.10.2 Add Ethnicity

Use to add a new ethnicity name to the Ethnicity selection list used in reference curve descriptions.

### 31.10.3 Restore

Use to restore the reference curve database to the original state as supplied by Hologic.

## 31.11 Rebuild Archive Index

Rebuilds the archived scans index file. Use if unable to see scans on archive media known to contain scans. Click **Rebuild Archive Index**.

## 31.12 Install Options

To perform the Install Options function:

1. Obtain a license key from Hologic for the option you want to install.
2. Select **Utilities > Install Options** from the main window **Menu Bar**.
3. Type the license key obtained from Hologic in the License Key field.
4. Click **Install Option**.
5. Follow instructions on the screen.
6. Select another option to install or click **Close**.

---

## 32 Reference Curve

Standard reference curves are provided by Hologic based on studies performed on Hologic QDR bone densitometers. Reference curves are sets of data points for a given sex, ethnicity, and scan type/region and specify standard deviation and skew value for the point.

Reference Curve allows users to setup and manipulate custom reference curve data.

Using Reference Curve you can:

- view reference curve record data
- create new reference curve records
- modify reference curve records (Hologic supplied reference curve records cannot be modified)
- delete reference curve records (Hologic supplied reference curve records cannot be deleted)
- create new ethnicity groups
- restore database to Hologic-supplied reference curves

Hologic-supplied reference curves cannot be edited or deleted. However, Hologic-supplied curves can be marked as current or non-current and they can be copied and edited to create a new reference curve.

### 32.1 Starting Reference Curve Editor

1. Select **Utilities > Reference Curve > Editor** from the Menu Bar of the main window.



**Note** *Modifying the contents of the Hologic supplied Reference Curve Database may change the T-scores, Z-scores, Peak Reference and Age Matched reference results.*

2. Click **OK** to display the Reference Curve Editor dialog box.



**Note** *An **H** in the Hologic field indicates a Hologic provided reference curve record that cannot be modified or deleted.*

### 32.2 Viewing Reference Curve Data

1. Start the Reference Curve Editor ([Section 32.1 Starting Reference Curve Editor](#) on Page 115).
2. Locate and click on the reference curve record line to view.
3. Click **View**.

The upper section of the View Reference Curve dialog box contains the reference curve description information. The lower section contains the reference curve point data. No changes can be made on this dialog box.



**Note** Refer to [Table 32](#) for descriptions of the fields on this screen.

4. Click **Close** to return to the **Reference Curve Editor** dialog box.
5. Click **Close** to return to the main screen.

### 32.3 Creating New Reference Curve Records



**Note** *New reference curve records can be easily created by copying an existing reference curve record where most of the data is to be the same as that of the existing record. Refer to [Section 32.4 Copying a Reference Curve Record](#) on Page 118.*

1. Start the Reference Curve Editor.
2. Click **New**. A curve is added to the database.
3. Click **OK** to display the *New Reference Curve* dialog box.

The upper section of the New Reference Curve dialog box contains the reference curve description information. The lower section lists the reference curve point data as it is added.



**Note** Refer to [Table 32](#) for descriptions of the fields on this screen.

4. Complete the reference curve description information in the upper section. Use the drop-down lists where available. Use the tab key to move between fields.
5. Click Select **X, Y** Labels.
6. Expand the label selection trees as required.
7. Click on one label in both the **X** Label and **Y** Label section.
8. Click **OK**.
9. Click Input to add a new set of points to the reference curve.
10. On the **Input Data** dialog box, complete the information fields, **S.D.** (standard deviation), and **L** (skew value for the point) fields and click **OK**.  
*The point set appears in the lower section sorted by the X-axis selection.*
11. Repeat Step 10 as required to add additional point sets. Or click **Cancel** to close the Input Record dialog box and continue.
12. If necessary, edit a point set by clicking on the desired point set and clicking the Edit button to display the **Edit Data** dialog box.
13. Change the information fields as required and click **OK**.  
*The point set appears in the lower section sorted by the X-axis selection.*



14. If necessary, delete a point set by clicking on the desired point set and clicking the Delete button.



**Note**      *You are about to delete the selected record! Are you sure you want to continue?*

15. Click **Yes** to continue.  
*The point set is removed from the lower section.*
16. Repeat Steps 14 and 15 as required to delete additional point sets.
17. When you have completed adding the reference curve, click Close to record the curve data. Click **OK** to return to the *Reference Curve Editor* dialog
18. Click **Close** to return to the main screen.

**Table 32 Reference Curve Description Fields**

Field	Description
<b>Sex</b>	Select from drop-down list.
<b>Ethnicity</b>	Select from drop-down list.
<b>Date</b>	Set by the system when a curve is created or modified. Cannot be edited.
<b>Author</b>	Identifier for person creating or modifying curve. Enter up to five characters.
<b>Source</b>	Identifier for supplier providing the reference curve data. Enter up to 61 characters.
<b>Comment</b>	Comments pertaining to the reference curve.
<b>Select X, Y Labels</b>	This button brings up the Select X, Y Labels window.
<b>X-Axis Label</b> <b>Display from - to</b>	X-axis label to display on reports. Range of X-axis data to display on reports between which the reference curve is considered to be valid. This does not necessarily correspond to the low and high points that define the curve.
<b>Y-Axis Label</b> <b>Display from - to</b>	Y-axis label to display on reports. Range used for the Y-axis in the graphical display. Does not effect the operation of Normals.

**Table 32 Reference Curve Description Fields**

Field	Description
<b>Is this curve current?</b>	Lets more than one reference curve (for the same sex, ethnic group, scan type, and bone region) on the system at the same time. Only one of these curves can be marked as current. Only current curves are used by Normals.
<b>Method</b>	Analysis method for the curve. Select from drop-down list.
<b>Scan Type</b>	Set by the system depending on the X, Y label selection when a curve is created or modified. Cannot be edited.
<b>Age Peak BMD</b>	Age of maximum bone density used to compute T-score. Visible when X-axis label is selected as “Age” and Y-axis label is selected as “BMD”.

## 32.4 Copying a Reference Curve Record

Copying an existing reference curve record makes it easy to create a new curve record where most of the data is to be the same as that of the existing record.

1. Start the **Reference Curve Editor**.
2. Locate and click on the reference curve record line to copy.
3. Click **Copy**. A curve is added to the database.
4. Click **OK**.

The upper section of the *Copy Reference Curve* dialog box contains fields to enter or change the reference curve description information. The lower section lists the current reference curve point data.

5. Change the reference curve description information in the upper section as required. Use the drop-down lists where available. Use the tab key to move between fields.
6. Please refer to [Section 32.3 Creating New Reference Curve Records](#) on Page 116 — *Steps 5 through 8* — for selecting X, Y labels.
7. **Please refer to** [Section 32.3 Creating New Reference Curve Records](#) on Page 116 — *Steps 9 through 16* for adding, editing, and/or deleting reference curve point data. Then continue with the following steps.
8. When you have completed changing the copied reference curve, click **Close** to record the curve data.  
Click **OK** to return to the *Reference Curve Editor* dialog box.
9. Click **Close** to return to the main screen.

## 32.5 Editing Reference Curve Records



**Note** *With the exception of the **Is the curve current?** field in the reference curve description section, Hologic-provided reference curve records cannot be modified.*

1. Start the Reference Curve Editor.
2. Locate and click on the reference curve record line to edit. *The line is highlighted.*
3. Click **Edit**.

The upper section of the *Edit Reference Curve* dialog box contains fields to enter or change the reference curve description information. The lower section lists the current reference curve point data.



**Note** *Refer to the [Table 32](#) for descriptions of the fields on this screen.*

4. Enter or modify the reference curve description information in the upper section. Use the drop-down lists where available. Use the tab key to move between fields.
5. Please refer to [Section 32.3 Creating New Reference Curve Records](#) on Page 116, Steps 5 through 8 for selecting X, Y labels.
6. Please refer to [Section 32.3 Creating New Reference Curve Records](#) on Page 116, Steps 9 through 16 for adding, editing, and/or deleting reference curve point data. Then continue with the following steps.
7. When you have completed changing the copied reference curve, click **Close** to record the curve data.  
Click **OK** to return to the *Reference Curve Editor* dialog box.
8. Click **Close** to return to the main screen.

## 32.6 Deleting Reference Curve Records



**Note** *Hologic provided reference curve records cannot be deleted.*

1. Start the Reference Curve Editor.
2. Locate and click on the reference curve record line to edit.
3. Click **Delete**.



**Note** *You are about to delete the selected record. This data and all results will be permanently **LOST!** Are you sure you want to continue?*

4. Click **Yes** to delete the selected record and return to the *Reference Curve Editor* dialog box.

5. Repeat Steps 2 through 4 to delete additional records, or click **Close** to return to the main screen.

### 32.7 Adding New Ethnic Groups

1. Select **Utilities > Reference Curve > Add Ethnicity** from the Menu Bar of the main window.



**Note** *If you plan to exchange data with other users, make sure your new ethnicity code does NOT match any of their ethnicity codes unless you are actually using the same reference curves for that ethnicity*

2. Click **OK** to display the **Add New Ethnicity** dialog box.
3. Type name and code (two alphanumeric characters) for the new ethnicity group into their respective fields and click **OK** to add the group and return to the **Main Screen**.

### 32.8 Restoring Reference Curve Database



**Note** *This option restores the reference curve database to the original state as supplied by Hologic. Any changes that may have been made are lost.*

1. Select **Utilities > Reference Curve > Restore** from the Menu Bar of the main window.



**Note** *This action will restore the reference curve database to the original state as supplied by Hologic, Inc. Any changes that may have been made will be lost. Proceed with Restore?*

2. Click **Yes** to restore the database. Or click **No** to stop the restore. The system returns to the **Main Screen**.

## 33 DICOM Option

Digital Imaging and Communications in Medicine (DICOM) is a powerful tool that provides:

- Interpreting physicians with the ability to view electronic QDR bone density scan and analysis results on a Picture Archiving and Communications System (PACS) viewer. The DICOM option allows results to be transmitted automatically over a facility's network directly to a physician's DICOM viewing station for interpretation and report dictation. The results can also be archived on the PACS, making them available for future reference and for distribution to others on the PACS network.
- The QDR system with the ability to retrieve schedule and patient demographic information when the Modality Worklist option is installed on the system.
- Locating and retrieving of scans that have been previously archived to a remote storage system (PACS) when the Query/Retrieve option is installed on the system.

## 34 Configure DICOM Option

### 34.1 DICOM Configuration Tabs

The following sections describe how to configure the Modality Worklist; add, edit, and delete DICOM Report Send remote destinations; add, edit, and delete DICOM Report Storage Commitment remote destinations; add, edit, and delete Query/Retrieve remote destinations; and configure the Host Machine (local system).

Settings for DICOM functions are controlled using the **System Configuration – DICOM** tab found under the **Utilities** pull-down menu in the main window.

The DICOM tab contains five tabs used to configure:

- Modality Worklist option (when installed)
- DICOM report send destinations (when installed)
- DICOM report storage commitment destinations (when installed)
- Query/Retrieve option (when installed)
- Host machine

### 34.2 Modality Worklist

The Modality Worklist option adds two tabs to the APEX software:

- A Worklist tab is added to the System Configuration – DICOM window to allow the configuration of the modality Worklist.

- A Worklist tab is added to the Select Patient for Exam window to allow the operator to receive schedules from the HIS/RIS to perform tasks on the QDR system.

#### 34.2.1 Configuring Modality Worklist



**Caution** *Changing information that configures the modality Worklist can cause serious communication disruptions with the HIS/RIS. Only authorized personnel should change settings.*

The Modality Worklist is configured by selecting **System Configuration** – **DICOM** tab – **Worklist** tab found under the **Utilities** pull down menu in the main window.

The Worklist tab is divided into seven areas used to control communication to and from the HIS/RIS and one area providing an option for obtaining Worklist data from an input file rather than from a remote Worklist provider.

- Query Parameters
- Auto Query Interval
- Query Retry Parameters
- Purge Interval
- Input from File
- Configure Worklist Provider
- Map Worklist Fields
- Local Ping (confirm network and PACS connection)

Each of these areas is explained below

### 34.3 Query Parameters

The user controls in this area perform the following:

- Filter the query by modality and AE Title.
- Determine a limit of entries to the Worklist database over a specified period of time.
- Determine if **Detailed Query** and **Extended Details** buttons will appear in the *Select a Patient for this Exam - Worklist* dialog.

Table 33 Query Parameters

Parameter	Function
<b>Days Back and Forward</b>	This provides the valid time range of the query. There is a pair of drop down menus labeled <b>Back</b> and <b>Forward</b> . If both of these are set to 0 (zero) then the valid range is for today's date only. If the <b>Back</b> drop-down menu is set to 7 and the <b>Forward</b> drop-down menu is set to 0 (zero) then the valid range of the query is one week, starting with today's date going back seven (7) days. The range for the drop-down menu for <b>Back</b> is 0 to 9 and the range for the drop-down menu for <b>Forward</b> is 0 to 8. Both <b>Back</b> and <b>Forward</b> drop-down menus can manually be set from 0 to 99.
<b>Modality</b>	Modality is the type of system recognized by the HIS/RIS. The default modality for the QDR System is "OT."
<b>AE Title</b>	AE stands for Application Entity. This is a text entry box that provides a unique name for the QDR system. Every QDR system will (or should) have an AE name that uniquely identifies that specific system.
<b>Maximum Hits Per Query</b>	This is an entry box that accepts a numeric value only. The number is the maximum number of query hits that will be passed to the QDR system specified in the <b>Days Back</b> and <b>Forward</b> . If there are more hits than the maximum, only the number specified in this box are passed to the QDR system.
<b>Enable Detailed Query</b>	A check box determining if a <b>Detailed Query</b> button and an <b>Extended Details</b> button will appear in the <i>Select a Patient for this Exam - Worklist</i> dialog when performing an exam. When checked both buttons will appear.

## 34.4 Auto Query Interval

Controls in this area are used set up a specific time interval during which the QDR system queries the provider to update the Worklist.

**Auto Query Interval** area contains three radio buttons, only one of which may be selected.



**Note** *These controls remain enabled when Input From file is enabled.*

Table 34 Auto Query Interval

Parameter	Function
Every Day At	This entry provides a control that allows the user to select the specific time each day that the QDR system will query the provider to update the Worklist.
Every	This entry provides two drop-down menus labeled <b>HR</b> and <b>Min</b> that specify a query to be made at the chosen time intervals (every <i>n</i> hours and <i>n</i> minutes).
Never	If <b>Never</b> is selected, the QDR system will not automatically query the provider to update the Worklist. With this selected, queries must be done manually by the operator.

### 34.5 Query Retry Parameters

If the provider did not respond to a query to update the Worklist for some reason (e.g., busy, off-line), controls in this area will determine how long the QDR system will wait for a response and give a specific time before trying the query again.

This entry contains a checkbox and three drop-down menus that control how long the QDR system will wait for the provider to respond to a query.



**Note** *These controls remain enabled when Input From file is enabled*

Table 35 Query Retry Parameters

Parameter	Function
Query Retry Checkbox	In order for the QDR system to perform a retry after a time-out period, there must be a check mark in this box. If there is no check mark in this box then the QDR system will continue to wait until the provider responds to the query to update the Worklist. To place a check mark in the box, click in the box.
Query Timeout	This is a drop-down menu labeled <b>Min</b> . The value in this drop-down menu tells the QDR system how long it can wait before retrying the query. <b>Min</b> has a range of 0 to 60 minutes in 5 minute intervals. The operator can enter a number from 0 – 99 manually.
Retry Number	This is a drop-down menu labeled <b>Times that</b> tells the QDR system how many times it may issue a retry. This drop-down menu allows a selection of 0, 1, 2, 3, 4, 5, 6, 7, 8, 9 or 10 for the number of retries. The operator can enter a number from 0 – 99 manually.



**Table 35 Query Retry Parameters**

Parameter	Function
<b>Retry Interval</b>	This is a drop-down menu labeled <b>Min that</b> tells the QDR system how long to wait between retries. This drop-down menu has a range of 10 to 90 minutes in 10 minute intervals. The operator can enter a number from 0-99 manually.

## 34.6 Purge Interval

Each time the provider responds to a query from the QDR system the Worklist entries are stored in a database on the QDR system. Use controls in this area to allow the database to be automatically purged (data removed) at a specific time.

These controls remain enabled when Input From file is enabled.

**Table 36 Purge Interval**

Parameter	Function
<b>Used Entries</b>	This is a drop-down menu labeled <b>Days</b> . The value in this drop-down menu provides a limit for storing those studies that have already been performed. The studies are purged (deleted) after the specified number of days. The range for <b>Used Entries</b> drop-down menu is 0 to 9 days. The <b>Used Entries</b> drop-down menu can be set manually to any number of days from 0 to 999.
<b>Unused Entries</b>	This is a drop-down menu labeled <b>Days</b> . The value in this drop-down menu provides a limit for storing those studies that have not been performed. These are purged (deleted) after the specified number of days. The range for the drop-down menu for <b>Unused Entries</b> is 0 to 9 days. The <b>Unused Entries</b> drop-down menu can be set manually to any number of days from 0 to 999.

## 34.7 Input From File

Provides an option for obtaining Worklist data from an input file generated by an electronic Medical Reporting System rather than from a remote Worklist provider.

**Table 37 Input From File**

Parameter	Function
<b>Enable</b>	<p>A check box determining whether or not the Input from File feature is enabled. When checked, Worklist data is obtained from an input file.</p>  <p><i>All controls on the Worklist tab not used for the Input from File feature are disabled when this box is checked.</i></p>
<b>Input File Name</b>	Displays a full path to the current Worklist file. This field is populated or changed using <b>Browse</b> to select a file path.
<b>... (Browse)</b>	Displays a “File Open” dialog allowing the user to locate a Worklist input file on the local system or network.

## 34.8 Worklist Provider

### 34.8.1 Worklist Provider Interface

The Worklist provider interface provides Worklist entries for the QDR system.

Refer to [Section 34.8.2 Worklist Provider Controls](#) on Page 126 for details.

**Table 38 Worklist Provider Features**

Parameter	Function
<b>Map Worklist Fields</b>	<p>Different hospitals and clinics may use the same DICOM attributes in various ways to identify their patients. Map Worklist Fields is used to ensure that data in the QDR system and in the HIS/RIS are addressing the same patient.</p> <p>Click <b>Map Worklist Fields</b>, on the Worklist Tab, to display a window called Map Worklist Keys that allows fields to be selected for patient verification by the QDR system and the HIS/RIS database. Once these entries are made, they will be checked on each study to verify that the QDR system and the HIS/RIS have identified the same patient.</p> <p>Refer to <a href="#">Section 34.9 Map Worklist Fields</a> on Page 128 for details.</p>
<b>Local Ping</b>	Confirms if the local system is connected to a network.

### 34.8.2 Worklist Provider Controls

Clicking **Configure Worklist Provider** displays a window used to define the Worklist provider.

The Worklist provider supplies Worklist entries for the QDR system.

### Worklist Provider

Use controls in this area to define the Worklist provider.

**Table 39 Worklist Provider**

Parameter	Function
<b>AE Title</b>	This is the Application Entity title of the Worklist provider.
<b>Remote Host</b>	This is the host name or IP address of the Worklist provider. The host name or IP address must be on the same network as the QDR workstation. Accepts up to 120 alphanumeric characters.
<b>Remote Port Number</b>	This is the port number of the Worklist provider.

### Performed Procedure Step

This area provides an option to automatically respond to a performed procedure provider once a specific task is performed in the Worklist.

**Table 40 Performed Procedure Step**

Control	Function
<b>Use Performed Procedure Step</b>	When checked, each time a study is completed a response is sent to the provider indicating that the task has been completed. To place a check mark in the box, click in the box.

### Provider

Use controls in this area to define the performed procedure step provider. The performed procedure provider may be the same as the Worklist provider or different.

**Table 41 Provider**

Control	Function
<b>Use Worklist Provider Data</b>	When checked, the performed procedure step provider is the same as the Worklist provider.
<b>AE Title</b>	This is the Application Entity title of the performed procedure step provider when <i>Use Worklist Provider Data</i> is unchecked.
<b>Remote Host</b>	This is the host name or IP address of the performed procedure step provider when <i>Use Worklist Provider Data</i> is unchecked. The host name or IP address must be on the same network as the QDR workstation. Accepts up to 120 alphanumeric characters.

**Table 41 Provider (Continued)**

Control	Function
Remote Port Number	This is the port number of the performed procedure step provider when <i>Use Worklist Provider Data</i> is unchecked.
Remote Ping	Confirms if the configured Worklist provider or Performed Procedure Step provider system is connected to the same network as the local system.
C-ECHO	Confirms if the configured Worklist provider or Performed Procedure Step provider system is a Picture Archival and Communications system (PACS)

## 34.9 Map Worklist Fields

Clicking **Map Worklist Fields** displays the *Map Worklist Keys* dialog box.



**Caution** *Do not change settings in the Map Worklist Fields without specific directions from your HIS/RIS department.*

This dialog box consist of 15 different drop-down menus with specific labels on the left. The labels indicate data that is in the Patient Biography on the QDR systems (some information, such as HL7 fields, may not apply to each QDR system). The information in the drop-down menus is information that may appear in the HIS/RIS database for the patient. The goal is to find information in the Patient Biography that matches information in the HIS/RIS database to be used as a key to verify that the patient in the Patient Biography is the same as the patient in the HIS/RIS database.

This task of matching information must be performed by someone with knowledge of both the QDR system and the operations of the HIS/RIS.

There are two sets of drop-down menus:

- **Patient Matching Keys** – six drop-down menus for Patient Matching
- **Other Keys** – nine drop-down menus for Key Mapping

The **Patient Matching** drop-down menus allow specific data in the Patient Biography of the QDR system to be mapped to data in the HIS/RIS database. These drop-down menus have check boxes to the left of the label. A check mark in any of these boxes means that the information in the Patient Biography must match the information in the HIS/RIS database to identify the same patient.

The **Key Mapping** drop-down menus provide data from the HIS/RIS database that can be mapped to specific information in the Patient Biography.

*Not Mapped* in any drop-down menu indicates that the field in the Patient Biography will not be mapped with any field in the HIS/RIS database.

## 34.10 DICOM Send Destinations

Send destinations define destinations to which the DICOM reports are transmitted when the **Send** function is used.

This section describes how to configure, add, edit, and delete a destination remote nodes and how to configure all Send destinations.

Send destinations are configured by selecting System Configuration — DICOM tab — Send tab found under the Utilities pull down menu in the main window.

**Table 42** DICOM Send Destinations

Parameter	Function
Configure DICOM Send Destinations	Selection list of existing DICOM Send destinations configured on the local system.
Add Destination	Displays a dialog that allows configuring a new Send destination
Edit Destination	<i>Enabled when one destination is selected.</i> Displays a dialog that allows changing the selected Send destination's configuration.
Delete Destination	<i>Enabled when one or more destinations are selected.</i> Deletes the selected Send destination(s).
Local Ping	Confirms whether or not the local system is connected to a network.
Remote Ping	<i>Enabled when one destination is selected.</i> Confirms whether or not the configured Send destination system is connected to the same network as the local system.
C-ECHO	<i>Enabled when one destination is selected.</i> Confirms whether or not the configured Send destination system is a Picture Archival and Communications system (PACS).
Configure Parameters	Click <b>Configure Parameters</b> to define the Send destination auto retry parameters and when to purge log entries. Refer to <a href="#">Section 34.10.2 Configure DICOM Send</a> on Page 133 for details.

1. To **add** a new destination:
  - a. Click **Add Destination**,

- b. Complete the *Add / Edit DICOM Send Destination* dialog fields (refer to [Section 34.10.1 Add / Edit DICOM Send Destination Dialog](#) on Page 131 for details), and
    - c. Click **OK**.
  2. To **reconfigure** an existing destination:
    - a. Select the destination in the selection list.
    - b. Click **Edit Destination**,
    - c. Edit the *Add / Edit DICOM Send Destination* dialog box as required (refer to [Section 34.10.1 Add / Edit DICOM Send Destination Dialog](#) on Page 131 for details).
    - d. Click **OK**.
  3. To **enable/disable** a destination for use:
    - a. click the check box in the Active column of the selection list for the destination to check/uncheck (check to enable).
  4. To **verify the local system is connected** to a local network:
    - a. Click **Local Ping**.
    - b. Click **OK** to close the resulting message.
  5. To **verify the destination is connected** to the same network as the local system:
    - a. Select the destination in the selection list
    - b. Click Remote Ping. Click **OK** to close the resulting message.
  6. To **verify** the destination is a PACS:
    - a. Select the destination in the selection list.
    - b. Click **C-ECHO**.
    - c. Click **OK** to close the resulting message.
  7. To **delete** a destination:
    - a. Select the destination in the selection list.
    - b. Click **Delete Destination**.
  8. To **define auto query parameters** for *all* configured Send destinations:
    - a. Click **Configure Parameters**.
    - b. Edit the **Configure DICOM Send** dialog box as required (refer to [Section 34.10.2 Configure DICOM Send](#) on Page 133 for details).
    - c. Click **OK**.
  9. Click **OK** to return to the **Main Screen**.

34.10.1 Add / Edit DICOM Send Destination Dialog

Table 43 DICOM Send Destinations

Parameter	Function
<b>AE Title</b>	<i>Application Entity</i> . Provides a unique name for the destination system. Accepts up to 16 alphanumeric characters. <b>Note:</b> To add the QDR workstation as a destination node, type local in the <b>AE Title</b> box.
<b>Host Name or IP Address</b>	Name or IP address of destination. The host name or IP address must be on the same network as the QDR workstation. Accepts up to 120 alphanumeric characters. <b>Note:</b> To add the QDR workstation as a destination node, type localhost in the <b>Host Name or IP Address</b> box.
<b>SCP Port</b>	Port number on destination. The default for the Service Class Provider Port number is 104. Accepts up to 5 numeric characters in the range of 1 - 65535.
<b>Destination Name</b>	Provides an alias name used for selecting a destination. Accepts up to 120 alphanumeric characters.
<b>Interpreting Physician</b>	An optional entry that provides the name of the physician interpreting the scan. Accepts up to 120 characters.
<b>Grayscale Only</b>	When checked, DICOM reports are converted into grayscale when sending to the selected destination. When unchecked, images for all report types that may contain graphs will be created in color. Images for all other report types (IVA, questionnaire, etc) will be created in grayscale.
<b>Presentation File</b>	When checked, a DICOM GSPS file will be sent along with an image DICOM file if needed for IVA scan. If checked and the node is also marked for storage commitment, then the commitment request will be issued for both image and GSPS DICOM files.
<b>IVA Results File</b>	When checked, a DICOM IVA Results file will be sent along with an image DICOM file if needed for IVA scan. If checked and the node is also marked for storage commitment, then the commitment request will be issued for both image and IVA Results DICOM files.

Table 43 DICOM Send Destinations

Parameter	Function
<b>Unicode</b>	<p>When checked, DICOM files are sent with Unicode coding. When using Unicode, an Extended Character Set attribute will be present in DICOM files. Text attributes will be populated with single byte strings converted from double byte strings using UTF-8 encoding.</p> <p>When not using Unicode, an Extended Character Set attribute will <u>not</u> be present in DICOM files. Text attributes will be populated with single byte strings converted from double byte strings using UTF-8 encoding.</p>
<b>Storage Commitment Provider</b>	<p>When checked, designates the destination is committed to storing information sent to it.</p> <p>When checked a storage commitment provider must be designated. To designate a storage commitment provider, select an existing provider from the drop-down list, or click <b>Add New Provider</b> to designate add a new storage commitment provider (refer to <a href="#">Section 34.12.1 Add / Edit DICOM Query/Retrieve Destination Dialog</a> on Page 139 for details on adding a new provider). Storage commitment providers can also be added using the System Configuration - DICOM tab - Commit tab (refer to <a href="#">Section 34.11 DICOM Storage Commitment Destinations</a> on Page 133 for details).</p>
<b>Scan Archive Location</b>	<p>Displays if the Enterprise Data Management option is installed. When checked, designates the destination is a scan archiving location and will implement the inclusion of P&amp;R files to the DICOM file.</p> <p>P files are QDR scan files that contain processing data for the scan.</p> <p>R files are QDR scan files that contain the raw data for the image. When checked, the Select Existing Provider field can be left blank to indicate the Send destination is also the scan archive location. Or, an existing scan archiving location can be selected from the drop-down list, or click Add New Provider to designate add a new scan archive location. Scan archive locations can also be added using the System Configuration - DICOM tab - Query/Retrieve tab (refer to <a href="#">Section 34.12 DICOM Query/Retrieve Destinations</a> on Page 137 for details).</p>
<b>OK</b>	<p>Validates data. If validation passes, the dialog is closed and the configure DICOM Send Destinations selection list is updated with new or changed data. If validation fails, a warning message displays.</p>



Table 43 DICOM Send Destinations

Parameter	Function
Cancel	Ignores all edits and closes the dialog.

### 34.10.2 Configure DICOM Send

Table 44 DICOM Send Configuration

Parameter	Function
Auto Retry Parameters	If the Send destination did not respond to a request for some reason (e.g., busy, off-line), controls in this area will determine how long the QDR system will wait for a response and give a specific time before trying the query again.
Retry Number	This is a entry box labeled <b>Times</b> that tells the QDR system how many times it may issue a retry. The <b>Retry Number</b> entry box can be set manually to any number of days from 0 to 99.
Retry Interval	This is a entry box labeled <b>Min</b> that tells the QDR system how long to wait between retries. The <b>Retry Interval</b> entry box can be set manually to any number of minutes from 1 to 1440.
Purge log entries after	This is a entry box labeled <b>days</b> . The value in this box provides a limit for storing DICOM Send log entries. The entries are purged (deleted) after the specified number of days. The <b>Purge log entries after</b> entry box can be set manually to any number of days from 0 to 99.
Auto-accession number	When checked, an accession number is automatically generated in the format SSSSSYYMMDDNNN, where SSSSS is the QDR serial number, YYMMDD is the current date, and NNN is a number starting at 001 and going up to 999.
Study Description	The contents of this edit box is used to populate the Study Description field in DICOM files if: <ul style="list-style-type: none"> <li>• the study is not a Worklist study, or the study is a Worklist study but the Study Description field is not mapped to any Worklist attribute</li> </ul> and, <ul style="list-style-type: none"> <li>• the edit box has a text entry (if left blank, the Study Description attribute is omitted)</li> </ul>

## 34.11 DICOM Storage Commitment Destinations

Storage commitment destinations define destinations to which the DICOM reports can be transmitted and stored when the **Send** function is used.

Storage Commitment destinations must be defined before defining DICOM Send destinations as storage commitment destinations.

This section describes how to configure, add, edit, and delete a storage commitment destination remote nodes and how to configure all Storage Commitment destinations.

Send destinations are configured by selecting **System Configuration – DICOM** tab – **Commit** tab found under the **Utilities** pull down menu in the main window.

### 34.11.1 Configure DICOM Send Destinations

Selection list of existing DICOM Storage Commitment destinations configured on the local system.

**Table 45 DICOM Storage Commitment Destinations**

Parameter	Function
<b>Add Destination</b>	Displays a dialog that allows configuring a new Storage Commitment destination
<b>Edit Destination</b>	<i>Enabled when one destination is selected.</i> Displays a dialog that allows changing the selected Storage Commitment destination's configuration.
<b>Delete Destination</b>	<i>Enabled when one or more destinations are selected.</i> Deletes the selected Storage Commitment destination(s).
<b>Local Ping</b>	Confirms whether or not the local system is connected to a network.
<b>Remote Ping</b>	<i>Enabled when one destination is selected.</i> Confirms whether or not the configured Storage Commitment destination is connected to the same network as the local system.
<b>C-ECHO</b>	<i>Enabled when one destination is selected.</i> Confirms whether or not the configured Storage Commitment destination is a Picture Archival and Communications system (PACS).
<b>Configure Parameters</b>	Click <b>Configure Parameters</b> to define the Storage Commitment destination auto retry parameters, when to purge log entries, and how DICOM storage commitment files are sent to a destination. Refer to <a href="#">Section 34.11.3 Configure Storage Commitment</a> on Page 136 for details.

1. To **add** a new destination:
  - a. Click **Add Destination**,

- b. Complete the *Add / Edit Storage Commitment* dialog fields (refer to [Section 34.11.2 Add / Edit Storage Commitment Destination Dialog](#) on Page 136 for details), and
  - c. Click **OK**.
2. To **reconfigure** an existing destination:
  - a. select the destination in the selection list.
  - b. Click **Edit Destination**
  - c. Edit the *Add / Edit Storage Commitment* dialog box as required (refer to [Section 34.11.2 Add / Edit Storage Commitment Destination Dialog](#) on Page 136 for details).
  - d. Click **OK**.
3. To **enable/disable** a destination for use:
  - a. Click the check box in the Active column of the selection list for the destination to check/uncheck (check to enable).
4. To **verify the local system is connected** to a local network:
  - a. Click **Local Ping**.
  - b. Click **OK** to close the resulting message.
5. To **verify the destination is connected** to the same network as the local system:
  - a. Select the destination in the selection list.
  - b. Click **Remote Ping**.
  - c. Click **OK** to close the resulting message.
6. To **verify** the destination is a PACS:
  - a. Select the destination in the selection list.
  - b. Click **C-ECHO**.
  - c. Click **OK** to close the resulting message.
7. To **delete** a destination:
  - a. Select the destination in the selection list.
  - b. Click **Delete Destination**.
8. To **define auto query parameters** for *all* configured Storage Commitment destinations:
  - a. Click **Configure Parameters**.
  - b. Edit the Configure Storage Commitment dialog box as required (refer to [Section 34.11.3 Configure Storage Commitment](#) on Page 136 for details).
  - c. Click **OK**.
9. Click **OK** to return to the **Main Screen**.

### 34.11.2 Add / Edit Storage Commitment Destination Dialog

**Table 46 Storage Commitment Destination Editing**

Parameter	Function
<b>AE Title</b>	<p><b>Application Entity</b> Provides a unique name for the destination system.  <i>Accepts up to 16 alphanumeric characters.</i></p> <p> To add the QDR workstation as a destination node, type <b>local</b> in the <b>AE Title</b> box.</p>
<b>Host Name or IP Address</b>	<p>Name or IP address of destination.  <i>The host name or IP address must be on the same network as the QDR workstation.</i>  <i>Accepts up to 120 alphanumeric characters.</i></p> <p> To add the QDR workstation as a destination node, type <b>localhost</b> in the <b>Host Name or IP Address</b> box.</p>
<b>SCP Port</b>	<p>Port number on destination.                      The default for the Service Class Provider Port number is 104.                      Accepts up to 5 numeric characters in the range of 1 - 65535.</p>
<b>Destination Name</b>	<p>Provides an alias name used for selecting destinations.                      Accepts up to 120 alphanumeric characters.</p>
<b>OK</b>	<p>Validates data. If validation passes, the dialog is closed and the configure DICOM Storage Commitment Destinations selection list is updated with new or changed data. If validation fails, a warning message displays.</p>
<b>Cancel</b>	<p>Ignores all edits and closes the dialog.</p>

### 34.11.3 Configure Storage Commitment

**Table 47 Storage Commitment Configuration**

Parameter	Function
<b>Auto Retry Parameters</b>	<p>If the Storage Commitment destination did not respond to a request for some reason (e.g., busy, off-line), controls in this area will determine how long the QDR system will wait for a response and give a specific time before trying the query again.</p>
<b>Retry Number</b>	<p>This entry box labeled <b>Times</b> tells the QDR system how many times it may issue a retry. The <b>Retry Number</b> entry box can be set manually to any number of days from 0 to 99.</p>
<b>Retry Interval</b>	<p>This entry box labeled <b>Min</b> tells the QDR system how long to wait between retries. The <b>Retry Interval</b> entry box can be set manually to any number of minutes from 1 to 1440.</p>

**Table 47 Storage Commitment Configuration**

Parameter	Function
<b>Mode</b>	DICOM files can be sent to a storage commitment destination as one file or all files per request.
<b>Image-by-image</b>	This radio button, when selected, tells the QDR system to issue a single storage commitment request for all DICOM files to be sent.
<b>Batch</b>	This radio button, when selected, tells the QDR system to issue a storage commitment request for each DICOM file to be sent.
<b>Purge log entries after</b>	This is a entry box labeled <b>days</b> . The value in this box provides a limit for storing DICOM Send log entries. The entries are purged (deleted) after the specified number of days. The <b>Purge log entries after</b> entry box can be set manually to any number of days from 0 to 99.

## 34.12 DICOM Query/Retrieve Destinations

Query/Retrieve allows the operator to query a remote location (PACS) for scans meeting given parameters and filters and to retrieve selective scans into the current computer. The scans must have been stored to that remote location prior to using the Query/Retrieve function.

This section describes how to configure, add, edit, and delete a destination remote node.

Query/Retrieve destinations are configured by selecting **System Configuration – DICOM tab – Query/Retrieve tab** found under the **Utilities** pull down menu in the main window.

**Table 48 DICOM Query/Retrieve Destinations**

Parameter	Function
Configure DICOM Query/Retrieve Destinations	Selection list of existing DICOM Query/Retrieve destinations configured on the QDR system.
Add Destination	Displays a dialog that allows configuring a new <b>Query/Retrieve</b> destination
Edit Destination	<i>Enabled when one destination is selected.</i> Displays a dialog that allows changing the selected Query/Retrieve destination's configuration.
Delete Destination	<i>Enabled when one or more destinations are selected.</i> Deletes the selected Query/Retrieve destination(s).

**Table 48 DICOM Query/Retrieve Destinations (Continued)**

Parameter	Function
Local Ping	Confirms whether or not the local system is connected to a network.
Remote Ping	<i>Enabled when one destination is selected.</i> Confirms whether or not the configured Query/Retrieve system is connected to the same network as the local system.
C-ECHO	<i>Enabled when one destination is selected.</i> Confirms whether or not the configured Query/Retrieve system is a Picture Archival and Communications system (PACS).

1. To **add** a new destination:
  - a. Click **Add Destination**.
  - b. Complete the *Add DICOM Query/Retrieve Destination* dialog fields.
  - c. Click **OK**.
2. To **reconfigure** an existing destination:
  - a. Select the destination in the selection list.
  - b. Click **Edit Destination**.
  - c. Edit the *Edit DICOM Query/Retrieve Destination* dialog box as required.
  - d. Click **OK**.
3. To **enable/disable** a destination for use:
  - a. Click the check box in the Active column of the selection list for the destination to check/uncheck (check to enable).
4. To **verify the local system is connected** to a local network:
  - a. Click **Local Ping**.
  - b. Click **OK** to close the resulting message.
5. To **verify the destination is connected** to the same network as the local system:
  - a. Select the destination in the selection list.
  - b. Click **Remote Ping**.
  - c. Click **OK** to close the resulting message.
6. To **verify** the destination is a PACS:
  - a. Select the destination in the selection list.
  - b. Click **C-ECHO**.
  - c. Click **OK** to close the resulting message.
7. To **delete** a destination:
  - a. Select the destination in the selection list.

- b. Click **Delete Destination**.
- 8. To configure **Query/Retrieve parameters**:
  - a. Click **Configure Parameters**. ([Section 34.12.2 Configure Query/Retrieve](#) on Page 139).
- 9. Click **OK** to return to the **Main Screen**.

### 34.12.1 Add / Edit DICOM Query/Retrieve Destination Dialog

**Table 49 Add / Edit DICOM Query/Retrieve Destination**

Parameter	Function
<b>AE Title</b>	<i>Application Entity</i> . Provides a unique name for the destination system. Accepts up to 16 alphanumeric characters.
<b>Host Name or IP Address</b>	Name or IP address of destination. The host name or IP address must be on the same network as the QDR workstation. Accepts up to 120 alphanumeric characters.
<b>SCP Port</b>	Port number on destination. The default for the Service Class Provider Port number is 104. Accepts up to 5 numeric characters in the range of 1 - 65536.
<b>OK</b>	Validates data. If validation passes, the dialog is closed and the Configure DICOM Query/Retrieve Destinations selection list is updated with new or changed data. If validation fails, a warning message displays.
<b>Cancel</b>	Ignores all edits and closes the dialog.

### 34.12.2 Configure Query/Retrieve

**Table 50 Query/Retrieve Configuration**

Parameter	Function
<b>Locate by Study</b>	Select to perform retrieve operations on the study level, i.e. the entire set of scans belonging to the same DICOM study as the selected scan will be retrieved.
<b>Locate by Series</b>	Select to perform a retrieve operation on the series level, i.e. a single scan corresponding to the given DICOM series will be retrieved.

## 34.13 Host

Host Machine defines your system when DICOM functions are used. The Host Machine is configured by selecting **System Configuration – DICOM** tab – **Host** tab found under the **Utilities** pull down menu in the main window.

Important: If changes are made to either the AE Title or Listening Port data, the APEX application must be restarted for the changes to take effect.

**Table 51 Host Configuration**

Parameter	Function
<b>Host DICOM Configuration</b>	Used to configure the Host.
<b>AE Title</b>	<i>Application Entity</i> Provides a unique name for the QDR system. Accepts up to 16 alphanumeric characters.
<b>Station Name</b>	Name of the QDR system. Accepts up to 120 alphanumeric characters.
<b>Listening Port</b>	Port number on which the QDR system listens. The default port number is 104. Accepts up to 5 numeric characters in the range of 1 – 65536.
<b>DICOM Send Modality</b>	Defines the value used to populate the Modality field in DICOM files for DICOM Send and Save operations.
<b>Modality</b>	This edit box defines the value entered into the Modality field in DICOM files. The default value is “OT” or the last saved value.
<b>Worklist sets modality</b>	When checked: If there is an entry in the Worklist database for a scan being saved or sent, then modality from the Worklist is used. If there is no entry in the Worklist database (either because the scan was not initiated using the Worklist, or because the Worklist entry has been already deleted), then the value from the Modality edit box is used.
<b>OK</b>	Validates data. If validation passes, the System Configuration window closes returning to the main screen. If validation fails, a warning message displays.
<b>Cancel</b>	Ignores all edits, closes the System Configuration window, and returns to the main screen.



## 35 FRAX FAQs

**In clinical practice I would prefer to use one year probabilities — why use 10-year fracture probability?**

In young healthy individuals (with a low mortality) the one year probability is approximately 10% of the 10-year probability. Thus, an individual with a 10-year fracture probability of 40% would have approximately a 1-year probability of 4%. Higher percentage figures are more readily understood by patients and clinicians.

**The clinical risk factors demand a yes or no response. However, two prior clinical fractures carry a greater risk than a single previous fracture. Why is this not accommodated?**

It is known that dose-responses exist for many of the clinical risk factors. In addition to the number of previous fractures, they include smoking, use of glucocorticoids and consumption of alcohol. The model is, however, based on information that is common to all the cohorts that participated in its creation and such detail is not available. This means that clinical judgement needs to be used when interpreting probabilities. A higher than average dose of glucocorticoids will carry a higher probability than that displayed. Conversely, a lower than average dose will signify a lower probability.

**A prior vertebral fracture carries a higher risk than a prior forearm fracture. How is this accounted for in the algorithms?**

It is not, for the reasons indicated in the question above. It should be noted, however, that a prior morphometric and asymptomatic vertebral fracture carries approximately the same risk as any previous fracture. A clinical vertebral fracture, however, carries a much higher risk (see reference list, Johnell et al 2006).

**How is account taken of ethnic minorities?**

It is not - with the exception of the United States where there is sufficient epidemiological information to make the appropriate adjustments.

**Why can't I use the tool to predict fracture risk in a 30 year old patient?**

The model is constructed from real data in population-based cohorts around the world that have a limited age range. If you enter an age below 40 years, the tool will calculate the probability of fracture at the age of 40 years. You must use your clinical judgement to interpret the risk.

**For the clinical risk factors, there is no provision for missing values (i.e., a "do not know" category) in the program. What should I do?**

Missing values are not provided for in our program. When calculating the 10-year probability it is assumed that every question (except BMD) can be answered. If you don't have information, for example on family history, you should answer no.

#### **Why not report the probability of all osteoporotic fractures? This would give larger values.**

Incorporating all osteoporotic fractures is problematic because of limited information on their epidemiology. From Swedish data, the inclusion of other major osteoporotic fractures (e.g. pelvis, other femoral fractures and tibial fractures) would increase the values by about 10 % (for example, in a patient with a calculated probability of major osteoporotic fractures of 5%, this might be uplifted to 5.5%). Including rib fractures would have a much larger effect. They are, however, difficult to diagnose.

#### **Why not include falls which are a well established clinical risk factor for fracture?**

Two reasons. The first is that the cohort data used to create the model reported falls in very different ways so that it was not possible to derive a standardized metric. Second, although plausible, pharmaceutical intervention has not been shown to reduce fracture risk in patients selected on the basis of a fall history. It is important that risk assessment models identify a risk that can be reduced by treatment.

#### **Why have you ignored fractures diagnosed on X-ray and focused on clinical vertebral fracture?**

A prior morphometric fracture has the same significance as any other prior fragility fracture and can be entered into the FRAX<sup>®</sup> model. The output does not, however, include the probability of a morphometric fracture. This is a conservative position, since their clinical significance is controversial (other than for risk prediction). Nevertheless, this does not affect who would be eligible for treatment.

#### **How do I decide who to treat?**

The FRAX assessment does not tell you who to treat which remains a matter of clinical judgment. In many countries, guidelines are provided that are based on expert opinion and/or on health economic grounds.

Additional information can be found at the WHO web site ([www.who.int](http://www.who.int)).



# HOLOGIC®



Hologic, Inc.  
36 Apple Ridge Road  
Danbury, CT 06810 USA

**Brazilian Contact**

Imex Medical Group do Brasil  
Rua das Embaúbas, 601 – Fazenda Santo Antônio  
São José/SC – Brasil – 88104-561  
Tel: +55 48 3251 8800  
[www.imexmedicalgroup.com.br](http://www.imexmedicalgroup.com.br)



Hologic BVBA  
Da Vincilaan 5  
1930 Zaventem  
Belgium  
Tel: +32 2 711 46 80  
Fax: +32 2 725 20 87

