

**HOLOGIC®**



# **ThinPrep® 5000 Processor**

Operator's Manual



# ThinPrep® 5000 Processor Operator's Manual

---

**HOLOGIC®**



Hologic, Inc.  
250 Campus Drive  
Marlborough, MA 01752 USA  
Tel: 1-800-442-9892  
1-508-263-2900  
Fax: 1-508-229-2795  
Web: [www.hologic.com](http://www.hologic.com)

**Caution:** Federal law restricts this device to sale by or on the order of a physician, or any other practitioner licensed by the law of the State in which the practitioner practices to use or order the use of the device and are trained and experienced in the use of the ThinPrep<sup>®</sup> 5000 processor.

Preparation of microscope slides using the ThinPrep 5000 processor should be performed only by personnel who have been trained by Hologic or by organizations or individuals designated by Hologic.

Evaluation of microscope slides produced with the ThinPrep 5000 processor should be performed only by cytotechnologists and pathologists who have been trained to evaluate ThinPrep-prepared slides by Hologic or by organizations or individuals designated by Hologic.

© Hologic, Inc., 2020. All rights reserved. No part of this publication may be reproduced, transmitted, transcribed, stored in a retrieval system, or translated into any language or computer language, in any form, or by any means, electronic, mechanical, magnetic, optical, chemical, manual, or otherwise, without the prior written permission of Hologic, 250 Campus Drive, Marlborough, Massachusetts, 01752, United States of America.

Although this guide has been prepared with every precaution to ensure accuracy, Hologic assumes no liability for any errors or omissions, nor for any damages resulting from the application or use of this information.

This product may be covered by one or more U.S. patents identified at <http://hologic.com/patentinformation>

Hologic, CytoLyt, PreservCyt, ThinPrep, and UroCyte are registered trademarks of Hologic, Inc. and/or its subsidiaries in the United States and/or other countries. All other trademarks are the property of their respective companies.

Changes or modifications to this unit not expressly approved by the party responsible for compliance could void the user's authority to operate the equipment.

Document Number: AW-19044-003 Rev. 002

10-2020



**Instructions For Use**

**Instructions For Use**



# ThinPrep<sup>®</sup> 5000 System

---

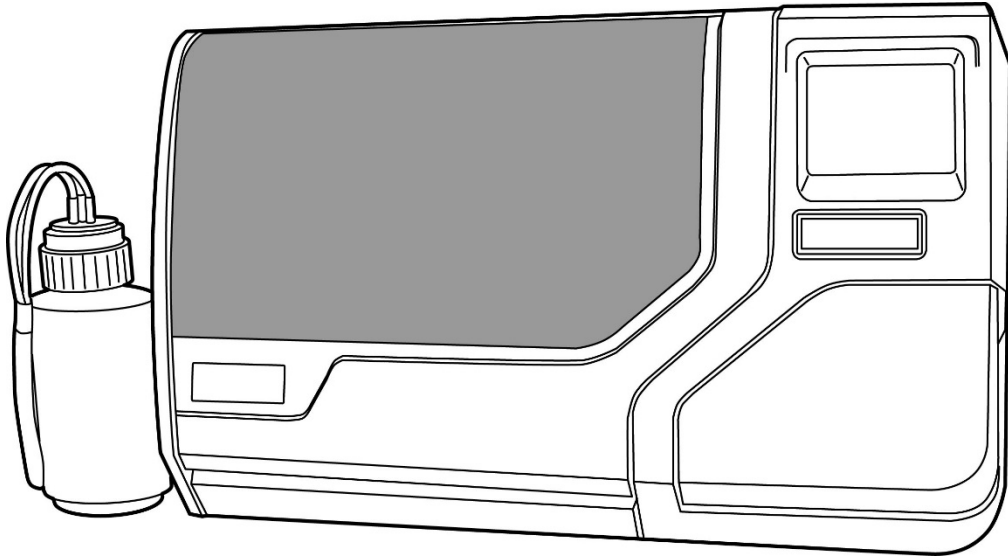

## Instructions For Use

CE

# INTENDED USE

---

The ThinPrep® 5000 System is intended as a replacement for the conventional method of Pap smear preparation for use in screening for the presence of atypical cells, cervical cancer, or its precursor lesions (Low-grade Squamous Intraepithelial Lesions, High-grade Squamous Intraepithelial Lesions), as well as all other cytologic categories as defined by *The Bethesda System for Reporting Cervical/Vaginal Cytologic Diagnoses*<sup>1</sup>.

# SUMMARY AND EXPLANATION OF THE SYSTEM

---

The ThinPrep process begins with the patient's gynecologic sample being collected by the clinician using a cervical sampling device which, rather than being smeared on a microscope slide, is immersed and rinsed in a vial filled with 20 ml of PreservCyt® Solution (PreservCyt). The ThinPrep sample vial is then capped, labeled, and sent to a laboratory equipped with a ThinPrep 5000 Processor.

At the laboratory, the PreservCyt sample vial is bar-coded along with the test request form to establish a sample chain of custody and is placed into a ThinPrep 5000 Processor. A glass slide bearing the same sample identification number as on the sample vial is loaded into the Processor. A gentle dispersion step mixes the cell sample by currents in the fluid that are strong enough to separate debris and disperse mucus, but gentle enough to have no adverse effect on cell appearance.

The cells are then captured on a Gynecological ThinPrep Pap Test Filter that is specifically designed to collect cells. The ThinPrep 5000 constantly monitors the rate of flow through the ThinPrep Pap Test Filter during the collection process in order to prevent the cellular presentation from being too scant or too dense. A thin layer of cells is then transferred to a glass slide in a 20 mm-diameter circle, and the slide is automatically deposited into a fixative solution.

## The ThinPrep Sample Preparation Process

### 1. Dispersion

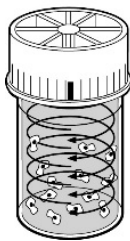

#### (1) Dispersion

The ThinPrep Pap Test Filter rotates within the sample vial, creating currents in the fluid that are strong enough to separate debris and disperse mucus, but gentle enough to have no adverse effect on cell appearance.

### 2. Cell Collection

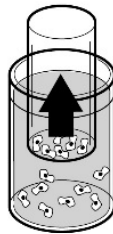

#### (2) Cell Collection

A gentle vacuum is created within the ThinPrep Pap Test Filter, which collects cells on the exterior surface of the membrane. Cell collection is controlled by the ThinPrep 5000 Processor's software that monitors the rate of flow through the ThinPrep Pap Test Filter.

### 3. Cell Transfer

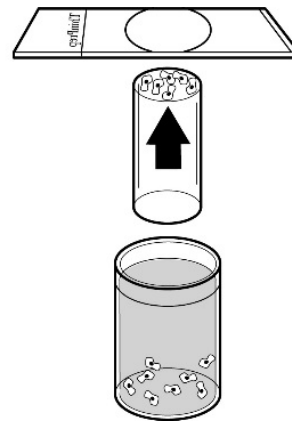

#### (3) Cell Transfer

After the cells are collected on the membrane, the ThinPrep Pap Test Filter is inverted and gently pressed against the ThinPrep Microscope Slide. Natural attraction and slight positive air pressure cause the cells to adhere to the ThinPrep Microscope Slide resulting in an even distribution of cells in a defined circular area.

As with conventional Pap smears, slides prepared with the ThinPrep® 5000 System are examined in the context of the patient's clinical history and information provided by other diagnostic procedures such as colposcopy, biopsy, and human papillomavirus (HPV) testing, to determine patient management.

The PreservCyt® Solution component of the ThinPrep 5000 System is an alternative collection and transport medium for gynecologic specimens tested with the Digene Hybrid Capture™ System HPV DNA and Hologic APTIMA COMBO 2® CT/NG Assays. Refer to the respective manufacturer's package inserts for instructions for using PreservCyt Solution for collection, transport, storage, and preparation of specimens for use in those systems.

The PreservCyt Solution component of the ThinPrep 5000 System is also an alternative collection and transport medium for gynecologic specimens tested with the Roche Diagnostics COBAS AMPLICOR™ CT/NG assay. Refer to Hologic's labeling (Document #MAN-02063-001) for instructions for using PreservCyt Solution for collection, transport, storage, and preparation of specimens and to the Roche Diagnostics COBAS AMPLICOR CT/NG package insert for instructions for use of that system.

## LIMITATIONS

---

- Gynecologic samples collected for preparation using the ThinPrep 5000 System should be collected using a broom-type or endocervical brush/plastic spatula combination collection devices. Refer to the instructions provided with the collection device for warnings, contraindications, and limitations associated with specimen collection.
- Preparation of microscope slides using the ThinPrep 5000 System should be performed only by personnel who have been trained by Hologic or by organizations or individuals designated by Hologic.
- Evaluation of microscope slides produced with the ThinPrep 5000 System should be performed only by cytotechnologists and pathologists who have been trained to evaluate ThinPrep prepared slides by Hologic or by organizations or individuals designated by Hologic.
- Supplies used by the ThinPrep 5000 System are those designed and supplied by Hologic specifically for the ThinPrep 5000 System. These include PreservCyt Solution vials, ThinPrep Pap Test Filters, and ThinPrep Microscope Slides. These supplies are required for proper performance of the system and cannot be substituted. Product performance will be compromised if other supplies are used. After use, supplies should be disposed of in accordance with local, state, and federal regulations.
- A ThinPrep Pap Test Filter must be used only once and cannot be reused.
- The performance of HPV DNA and CT/NG testing on sample vials reprocessed with glacial acetic acid (GAA) has not been evaluated.

## CONTRAINDICATIONS

- *Chlamydia trachomatis* and *Neisseria gonorrhoeae* testing using the Hologic APTIMA COMBO 2<sup>®</sup> CT/NG and the Roche Diagnostics COBAS AMPLICOR assays should not be performed on a sample that has already been processed using the ThinPrep 3000 processor.

## WARNINGS

- For In Vitro Diagnostic Use
- Danger. PreservCyt Solution contains methanol. Toxic if swallowed. Toxic if inhaled. Causes damage to organs. Flammable liquid and vapor. Keep away from heat, sparks, open flames and hot surfaces. Other solutions cannot be substituted for PreservCyt Solution. PreservCyt Solution should be stored and disposed of in accordance with all applicable regulations.

## PRECAUTIONS

- This equipment generates, uses and can radiate radio frequency energy, and if not installed and used in accordance with the Operator's Manual, may cause interference to radio communications. Operation of this equipment in a residential area is likely to cause harmful interference, in which case the user will be required to correct the interference at his/her own expense.
- PreservCyt Solution *with* cytologic sample intended for ThinPrep Pap testing must be stored between 15°C (59°F) and 30°C (86°F) and tested within 6 weeks of collection.
- PreservCyt Solution *with* cytologic sample intended for CT/NG testing using the Roche Diagnostics COBAS AMPLICOR CT/NG test must be stored between 4°C (39°F) and 25°C (77°F) and tested within 6 weeks of collection.
- PreservCyt Solution was challenged with a variety of microbial and viral organisms. The following table presents the starting concentrations of viable organisms, and the log reduction of viable organisms found after 15 minutes in the PreservCyt Solution. As with all laboratory procedures, universal precautions should be followed.

Organism	Initial Concentration	Log Reduction After 15 Minutes
<i>Candida albicans</i>	5.5 x 10 <sup>5</sup> CFU/ml	≥4.7
<i>Candida auris</i>	2.6 x 10 <sup>5</sup> CFU/ml	≥5.4
<i>Aspergillus niger</i>	4.8 x 10 <sup>5</sup> CFU/ml	2.7*
<i>Escherichia coli</i>	2.8 x 10 <sup>5</sup> CFU/ml	≥4.4
<i>Staphylococcus aureus</i>	2.3 x 10 <sup>5</sup> CFU/ml	≥4.4
<i>Pseudomonas aeruginosa</i>	2.5 x 10 <sup>5</sup> CFU/ml	≥4.4
<i>Mycobacterium tuberculosis</i> <sup>†</sup>	9.4 x 10 <sup>5</sup> CFU/ml	4.9**
Rabbitpox virus	6.0 x 10 <sup>6</sup> PFU/ml	5.5***
HIV-1	3.2 x 10 <sup>7</sup> TCID <sub>50</sub> /ml	≥7.0***
Hepatitis B virus <sup>†</sup>	2.2 x 10 <sup>6</sup> TCID <sub>50</sub> /ml	≥4.25
SARS-CoV-2 virus	1.8 x 10 <sup>6</sup> TCID <sub>50</sub> /ml	≥3.75
* After 1 hour 4.7 log reduction		
** After 1 hour 5.7 log reduction		
*** Data is for 5 minutes		

Organism	Initial Concentration	Log Reduction After 15 Minutes
† Organisms were tested with similar organisms from the same genus to assess antimicrobial effectiveness		
<i>Note:</i> All log reduction values with a $\geq$ designation yielded undetectable microbial presence after exposure to PreservCyt Solution. The listed values represent the minimum allowable claim given the initial concentration and the detection limit of the quantitative method.		

## PERFORMANCE CHARACTERISTICS: REPORT OF CLINICAL STUDIES

---

The ThinPrep 5000 System is technologically similar to the ThinPrep 2000 System. A critical review of the ThinPrep 5000 System demonstrated that the clinical evaluation of the ThinPrep 2000 System applies to the ThinPrep 5000 System and is described below.

A prospective multi-center clinical study was conducted to evaluate the performance of the ThinPrep 2000 System in direct comparison to the conventional Pap smear. The objective of the ThinPrep clinical study was to demonstrate that gynecologic specimens prepared using the ThinPrep 2000 System were at least as effective as conventional Pap smears for the detection of atypical cells and cervical cancer or its precursor lesions in a variety of patient populations. In addition, an assessment of specimen adequacy was performed.

The initial clinical study protocol was a blinded, split sample, matched pair study, for which a conventional Pap smear was prepared first, and the remainder of the sample (the portion that normally would have been discarded) was immersed and rinsed into a vial of PreservCyt Solution. At the laboratory, the PreservCyt sample vial was placed into a ThinPrep 2000 Processor and a slide was then prepared from the patient's sample. ThinPrep and conventional Pap smear slides were examined and diagnosed independently. Reporting forms containing patient history as well as a checklist of all possible categories of The Bethesda System were used to record the results of the screening. A single independent pathologist reviewed all discrepant and positive slides from all sites in a blinded fashion to provide a further objective review of the results.

### LABORATORY AND PATIENT CHARACTERISTICS

Cytology laboratories at three screening centers (designated as S1, S2, and S3) and three hospital centers (designated as H1, H2, and H3) participated in the clinical study. The screening centers in the study serve patient populations (screening populations) with rates of abnormality (Low-grade Squamous Intraepithelial Lesion [LSIL] and more severe lesions) similar to the United States average of less than 5%.<sup>2</sup> The hospital centers in the study serve a high risk referral patient population (hospital populations) characterized by high rates (>10%) of cervical abnormality. Data on race demographics was obtained for 70% of the patients that participated in the study. The study population consisted of the following race groups: Caucasian (41.2%), Asian (2.3%), Hispanic (9.7%), African American (15.2%), Native American (1.0%) and other groups (0.6%).

Table 1 describes the laboratories and the patient populations.

**Table 1: Site Characteristics**

Site	Laboratory Characteristics			Clinical Study Demographics			
	Type of Patient Population	Laboratory Volume - Smears per Year	Cases	Patient Age Range	Post-Meno-pausal	Previous Abnormal Pap Smear	Convent. Prevalence LSIL+
S1	Screening	300,000	1,386	18.0 - 84.0	10.6%	8.8%	2.3%
S2	Screening	100,000	1,668	18.0 - 60.6	0.3%	10.7%	2.9%
S3	Screening	96,000	1,093	18.0 - 48.8	0.0%	7.1%	3.8%
H1	Hospital	35,000	1,046	18.1 - 89.1	8.1%	40.4%	9.9%
H2	Hospital	40,000	1,049	18.1 - 84.4	2.1%	18.8%	12.9%
H3	Hospital	37,000	981	18.2 - 78.8	11.1%	38.2%	24.2%

# CLINICAL STUDY RESULTS

The diagnostic categories of The Bethesda System were used as the basis of the comparison between conventional and ThinPrep® findings from the clinical study. The diagnostic classification data and statistical analyses for all clinical sites are presented in Tables 2 through 11. Cases with incorrect paperwork, patient's age less than 18 years, cytologically unsatisfactory slides, or patients with a hysterectomy were excluded from this analysis. Few cases of cervical cancer (0.02%<sup>3</sup>) were represented in the clinical study, as is typical in the United States patient population.

**Table 2: Diagnostic Classification Table, All Categories**

		Conventional							TOTAL
		NEG	ASCUS	AGUS	LSIL	HSIL	SQ CA	GL CA	
ThinPrep	NEG	5224	295	3	60	11	0	0	5593
	ASCUS	318	125	2	45	7	0	0	497
	AGUS	13	2	3	0	1	0	1	20
	LSIL	114	84	0	227	44	0	0	469
	HSIL	11	15	0	35	104	2	0	167
	SQ CA	0	0	0	0	0	1	0	1
	GL CA	0	0	0	0	0	0	0	0
	TOTAL	5680	521	8	367	167	3	1	6747

Abbreviations for Diagnoses: *NEG* = Normal or negative, *ASCUS* = Atypical Squamous Cells of Undetermined Significance, *AGUS* = Atypical Glandular Cells of Undetermined Significance, *LSIL* = Low-grade Squamous Intraepithelial Lesion, *HSIL* = High-grade Squamous Intraepithelial Lesion, *SQ CA* = Squamous Cell Carcinoma, *GL CA* = Glandular Cell Adenocarcinoma

**Table 3: Three Category Diagnostic Classification Table**

		Conventional			TOTAL
		NEG	ASCUS/AGUS+	LSIL+	
ThinPrep	NEG	5224	298	71	5593
	ASCUS/AGUS+	331	132	54	517
	LSIL+	125	99	413	637
	TOTAL	5680	529	538	6747

**Table 4: Two Category Diagnostic Classification Table, LSIL and More Severe Diagnoses**

		Conventional		TOTAL
		NEG/ASCUS/AGUS+	LSIL+	
ThinPrep	NEG/ASCUS/AGUS+	5985	125	6110
	LSIL+	224	413	637
	TOTAL	6209	538	6747

**Table 5: Two Category Diagnostic Classification Table, ASCUS/AGUS and More Severe Diagnoses**

		<b>NEG</b>	<b>ASCUS/AGUS+</b>	<b>TOTAL</b>
<b>ThinPrep</b>	<b>NEG</b>	<b>5224</b>	<b>369</b>	<b>5593</b>
	<b>ASCUS/AGUS+</b>	<b>456</b>	<b>698</b>	<b>1154</b>
	<b>TOTAL</b>	<b>5680</b>	<b>1067</b>	<b>6747</b>

The diagnostic data analysis from the sites is summarized in Table 6 and 7. When the p-value is significant (p < 0.05), the method favored is indicated in the tables.

**Table 6: Results by Site, LSIL and More Severe Lesions**

Site	Cases	ThinPrep LSIL+	Convent. LSIL+	Increased Detection*	p-Value	Method Favored
<b>S1</b>	1,336	46	31	48%	0.027	ThinPrep
<b>S2</b>	1,563	78	45	73%	<0.001	ThipPrep
<b>S3</b>	1,058	67	40	68%	<0.001	ThinPrep
<b>H1</b>	971	125	96	30%	<0.001	ThinPrep
<b>H2</b>	1,010	111	130	(15%)	0.135	Neither
<b>H3</b>	809	210	196	7%	0.374	Neither

$$*Increased\ detection = \frac{ThinPrep^{\circledR}\ LSIL+ - Conventional\ LSIL+}{Conventional\ LSIL+} \times 100\%$$

*For LSIL and more severe lesions, the diagnostic comparison statistically favored the ThinPrep<sup>®</sup> method at four sites and was statistically equivalent at two sites.*

**Table 7: Results by Site, ASCUS/AGUS and More Severe Lesions**

Site	Cases	ThinPrep ASCUS+	Convent. ASCUS+	Increased Detection*	p-Value	Method Favored
<b>S1</b>	1,336	117	93	26%	0.067	Neither
<b>S2</b>	1,563	124	80	55%	<0.001	ThinPrep
<b>S3</b>	1,058	123	81	52%	<0.001	ThinPrep
<b>H1</b>	971	204	173	18%	0.007	ThinPrep
<b>H2</b>	1,010	259	282	(8%)	0.360	Neither
<b>H3</b>	809	327	358	(9%)	0.102	Neither

$$*Increased\ detection = \frac{ThinPrep\ ASCUS+ - Conventional\ ASCUS+}{Conventional\ ASCUS+} \times 100\%$$

*For ASCUS/AGUS and more severe lesions, the diagnostic comparison statistically favored the ThinPrep method at three sites and was statistically equivalent at three sites.*

One pathologist served as an independent reviewer for the six clinical sites, receiving both slides from cases where the two methods were either abnormal or discrepant. Since a true reference cannot be determined in such studies and therefore true sensitivity cannot be calculated, the use of an expert cytologic review provides an alternative to histologic confirmation by biopsy or human papillomavirus (HPV) testing as a means for determining the reference diagnosis.



The reference diagnosis was the more severe diagnosis from either of the ThinPrep or conventional Pap slides as determined by the independent pathologist. The number of slides diagnosed as abnormal at each site, compared to the reference diagnosis of the independent pathologist, provides the proportion of LSIL or more severe lesions (Table 8) and the proportion of ASCUS/AGUS or more severe lesions (Table 9). The statistical analysis allows a comparison of the two methods and a determination of which method is favored when using the independent pathologist for expert cytologic review as the adjudicator of the final diagnosis.

**Table 8: Independent Pathologist Results by Site, LSIL and More Severe Lesions**

Site	Cases Positive by Independent Pathologist	ThinPrep Positive	Conventional Positive	p-Value	Method Favored
S1	50	33	25	0.0614	Neither
S2	65	48	33	0.0119	ThinPrep
S3	77	54	33	<0.001	ThinPrep
H1	116	102	81	<0.001	ThinPrep
H2	115	86	90	0.607	Neither
H3	126	120	112	0.061	Neither

*For LSIL and more severe lesions, the diagnostic comparison statistically favored the ThinPrep method at three sites and was statistically equivalent at three sites.*

**Table 9: Independent Pathologist Results by Site, ASCUS/AGUS and More Severe Lesions**

Site	Cases Positive by Independent Pathologist	ThinPrep <sup>®</sup> Positive	Conventional Positive	p-Value	Method Favored
S1	92	72	68	0.0511	Neither
S2	101	85	59	0.001	ThinPrep
S3	109	95	65	<0.001	ThinPrep
H1	170	155	143	0.090	Neither
H2	171	143	154	0.136	Neither
H3	204	190	191	1.000	Neither

*For ASCUS/AGUS and more severe lesions, the diagnostic comparison statistically favored the ThinPrep method at two sites and was statistically equivalent at four sites.*

Table 10 below shows the summary for all sites of the descriptive diagnosis for all Bethesda System categories.

**Table 10: Summary of Descriptive Diagnosis**

Descriptive Diagnosis <i>Number of Patients: 6747</i>	ThinPrep		Conventional	
	N	%	N	%
<b>Benign Cellular Changes:</b>	<b>1592</b>	<b>23.6</b>	<b>1591</b>	<b>23.6</b>
<b>Infection:</b>				
Trichomonas Vaginalis	136	2.0	185	2.7
Candida spp.	406	6.0	259	3.8
Coccobacilli	690	10.2	608	9.0
Actinomyces spp.	2	0.0	3	0.0
Herpes	3	0.0	8	0.1
Other	155	2.3	285	4.2
<b>Reactive Cellular Changes Associated with:</b>				
Inflammation	353	5.2	385	5.7
Atrophic Vaginitis	32	0.5	48	0.7
Radiation	2	0.0	1	0.0
Other	25	0.4	37	0.5
<b>Epithelial Cell Abnormalities:</b>	<b>1159</b>	<b>17.2</b>	<b>1077</b>	<b>16.0</b>
<b>Squamous Cell:</b>				
ASCUS	501	7.4	521	7.7
favor reactive	128	1.9	131	1.9
favor neoplastic	161	2.4	140	2.1
undetermined	213	3.2	250	3.7
LSIL	469	7.0	367	5.4
HSIL	167	2.5	167	2.5
Carcinoma	1	0.0	3	0.0
<b>Glandular Cell:</b>				
Benign Endometrial cells in Postmenopausal Women	7	0.1	10	0.1
Atypical Glandular Cells (AGUS)	21	0.3	9	0.1
favor reactive	9	0.1	4	0.1
favor neoplastic	0	0.0	3	0.0
undetermined	12	0.2	2	0.0
Endocervical Adenocarcinoma	0	0.0	1	0.0

*Note: Some patients had more than one diagnostic subcategory.*

Table 11 shows the rates of detection for infection, reactive changes, and the total benign cellular changes for both the ThinPrep® and conventional methods at all sites.

**Table 11: Benign Cellular Changes Results**

	ThinPrep		Conventional	
	N	%	N	%
<b>Benign Cellular Changes</b>				
<b>Infection</b>	1392	20.6	1348	20.0
<b>Reactive Changes</b>	412	6.1	471	7.0
<b>Total*</b>	1592	23.6	1591	23.6

\* Total includes some patients that may have had both an infection and reactive cellular change.

Tables 12, 13, and 14 show the specimen adequacy results for the ThinPrep method and conventional smear method for all of the study sites. Of the 7,360 total patients enrolled, 7,223 are included in this analysis. Cases with patient's age less than 18 years or patients with a hysterectomy were excluded from this analysis.

Two additional clinical studies were conducted to evaluate specimen adequacy results when samples were deposited directly into the PreservCyt® vial, without first making a conventional Pap smear. This specimen collection technique is the intended use for the ThinPrep 2000 System. Tables 15 and 16 present the split sample and direct to vial results.

**Table 12: Summary of Specimen Adequacy Results**

Specimen Adequacy <i>Number of Patients: 7223</i>	ThinPrep		Conventional	
	N	%	N	%
<b>Satisfactory</b>	<b>5656</b>	<b>78.3</b>	<b>5101</b>	<b>70.6</b>
<b>Satisfactory for Evaluation but Limited by:</b>	<b>1431</b>	<b>19.8</b>	<b>2008</b>	<b>27.8</b>
Air-Drying Artifact	1	0.0	136	1.9
Thick Smear	9	0.1	65	0.9
Endocervical Component Absent	1140	15.8	681	9.4
Scant Squamous Epithelial Component	150	2.1	47	0.7
Obscuring Blood	55	0.8	339	4.7
Obscuring Inflammation	141	2.0	1008	14.0
No Clinical History	12	0.2	6	0.1
Cytolysis	19	0.3	119	1.6
Other	10	0.1	26	0.4
<b>Unsatisfactory for Evaluation:</b>	<b>136</b>	<b>1.9</b>	<b>114</b>	<b>1.6</b>
Air-Drying Artifact	0	0.0	13	0.2
Thick Smear	0	0.0	7	0.1
Endocervical Component Absent	25	0.3	11	0.2
Scant Squamous Epithelial Component	106	1.5	47	0.7
Obscuring Blood	23	0.3	58	0.8
Obscuring Inflammation	5	0.1	41	0.6
No Clinical History	0	0.0	0	0.0
Cytolysis	0	0.0	4	0.1
Other	31	0.4	9	0.1

*Note: Some patients had more than one subcategory.*

**Table 13: Specimen Adequacy Results**

		Conventional			
		SAT	SBLB	UNSAT	TOTAL
ThinPrep	SAT	4316	1302	38	5656
	SBLB	722	665	44	1431
	UNSAT	63	41	32	136
	TOTAL	5101	2008	114	7223

*SAT=Satisfactory, SBLB=Satisfactory But Limited By, UNSAT=Unsatisfactory*

**Table 14: Specimen Adequacy Results by Site**

Site	Cases	Thin Prep SAT Cases	Con-vent. SAT Cases	Thin Prep SBLB Cases	Con-vent. SBLB Cases	Thin Prep UNSAT Cases	Con-vent. UNSAT Cases
<b>S1</b>	1,386	1092	1178	265	204	29	4
<b>S2</b>	1,668	1530	1477	130	178	8	13
<b>S3</b>	1,093	896	650	183	432	14	11
<b>H1</b>	1,046	760	660	266	375	20	11
<b>H2</b>	1,049	709	712	323	330	17	7
<b>H3</b>	981	669	424	264	489	48	68
<b>All Sites</b>	7,223	5656	5101	1431	2008	136	114

The Satisfactory But Limited By (SBLB) category can be broken down into many subcategories, one of which is the absence of Endocervical Component. Table 15 shows the Satisfactory But Limited By category “No ECC’s” for ThinPrep® and conventional slides.

**Table 15: Specimen Adequacy Results by Site, SBLB Rates for no Endocervical Component.**

<b>SBLB Due to No ECC’s</b>					
Site	Cases	ThinPrep SBLB-no ECC’s	ThinPrep SBLB-no ECC’s (%)	Conventional SBLB-no ECC’s	Conventional SBLB-no ECC’s (%)
<b>S1</b>	1,386	237	17.1%	162	11.7%
<b>S2</b>	1,668	104	6.2%	73	4.4%
<b>S3</b>	1,093	145	13.3%	84	7.7%
<b>H1</b>	1,046	229	21.9%	115	11.0%
<b>H2</b>	1,049	305	29.1%	150	14.3%
<b>H3</b>	981	120	12.2%	97	9.9%
<b>All Sites</b>	7,223	1140	15.8%	681	9.4%

For the results of the clinical study involving a split-sample protocol, there was a 6.4 percent difference between conventional and ThinPrep methods in detecting endocervical component. This is similar to previous studies using a split sample methodology.

## **DIRECT-TO-VIAL ENDOCERVICAL COMPONENT (ECC) STUDIES**

For the intended use of the ThinPrep® 2000 System, the cervical sampling device will be rinsed directly into a PreservCyt® vial, rather than splitting the cellular sample. It was expected that this would result in an increase in the pick-up of endocervical cells and metaplastic cells. To verify this hypothesis, two studies were performed using the direct-to-vial method and are summarized in Table 16. Overall, no difference was found between ThinPrep and conventional methods in these two studies.

**Table 16: Summary of Direct-to-vial Endocervical Component (ECC) Studies**

Study	Number of Evaluable Patients	SBLB due to No Endocervical Component	Comparable Conventional Pap Smear Percentage
Direct-to-Vial Feasibility	299	9.36%	9.43% <sup>1</sup>
Direct-to-Vial Clinical Study	484	4.96%	4.38% <sup>2</sup>

1. Direct-to-Vial Feasibility study compared to overall clinical investigation conventional Pap smear SBLB-No Endocervical Component rate.

2. Direct-to-Vial Clinical study compared to site S2 clinical investigation conventional Pap smear SBLB-No Endocervical Component rate.

## DIRECT-TO-VIAL HSIL+ STUDY

Following initial FDA approval of the ThinPrep System, Hologic conducted a multi-site direct-to-vial clinical study to evaluate the ThinPrep 2000 System versus conventional Pap smear for the detection of High Grade Squamous Intraepithelial and more severe lesions (HSIL+). Two types of patient groups were enrolled in the trial from ten (10) leading academic hospitals in major metropolitan areas throughout the United States. From each site, one group consisted of patients representative of a routine Pap test screening population and the other group made up of patients representative of a referral population enrolled at the time of colposcopic examination. The ThinPrep specimens were collected prospectively and compared against a historical control cohort. The historical cohort consisted of data collected from the same clinics and clinicians (if available) used to collect the ThinPrep specimens. These data were collected sequentially from patients seen immediately prior to the initiation of the study.

The results from this study showed a detection rate of 511 / 20,917 for the conventional Pap smear versus 399 / 10,226 for the ThinPrep slides. For these clinical sites and these study populations, this indicates a 59.7% increase in detection of HSIL+ lesions for the ThinPrep specimens. These results are summarized in Table 17.

**Table 17: Summary of Direct-to-Vial HSIL+ Study**

Site	Total CP (n)	HSIL+	Percent (%)	Total TP (n)	HSIL+	Percent (%)	Percent Change (%)
S1	2,439	51	2.1	1,218	26	2.1	+2.1
S2	2,075	44	2.1	1,001	57	5.7	+168.5
S3	2,034	7	0.3	1,016	16	1.6	+357.6
S4	2,043	14	0.7	1,000	19	1.9	+177.3
S5	2,040	166	8.1	1,004	98	9.8	+20.0
S6	2,011	37	1.8	1,004	39	3.9	+111.1
S7	2,221	58	2.6	1,000	45	4.5	+72.3
S8	2,039	61	3.0	983	44	4.5	+49.6
S9	2,000	4	0.2	1,000	5	0.5	+150.0
S10	2,015	69	3.4	1,000	50	5.0	+46.0
<b>Total</b>	20,917	511	2.4	10,226	399	3.9	59.7(p<0.001)

Percent Change (%) = ((TP HSIL+/TP Total)/(CP HSIL+/CP Total)-1) \*100

## GLANDULAR DISEASE DETECTION – PUBLISHED STUDIES

The detection of endocervical glandular lesions is an essential function of the Pap test. However, abnormal glandular cells in the Pap sample may also originate from the endometrium or from extrauterine sites. The Pap test is not intended to be a screening test for such lesions.

When suspected glandular abnormalities are identified, their accurate classification as true glandular versus squamous lesions is important for proper evaluation and subsequent treatment (*e.g.* choice of excisional biopsy method versus conservative follow-up). Multiple peer-reviewed publications<sup>4-9</sup> report on the improved ability of the ThinPrep 2000 System to detect glandular disease versus the conventional Pap smear. Although these studies do not consistently address sensitivity of different Pap testing methods in detecting specific types of glandular disease, the reported results are consistent with more frequent biopsy confirmation of abnormal glandular findings by the ThinPrep Pap Test compared to conventional cytology.

Thus, the finding of a glandular abnormality on a ThinPrep Pap Test slide merits increased attention for definitive evaluation of potential endocervical or endometrial pathology.

## CONCLUSIONS

---

The ThinPrep® 2000 System is as effective as the conventional Pap smear in a variety of patient populations and may be used as a replacement for the conventional Pap smear method for the detection of atypical cells, cervical cancer, or its precursor lesions, as well as all other cytologic categories as defined by The Bethesda System. Since the ThinPrep 5000 System is technologically similar to the ThinPrep 2000 System, we conclude that the ThinPrep 5000 System is also as effective as the conventional Pap smear in a variety of patient populations and may be used as a replacement for the conventional Pap smear method for the detection of atypical cells, cervical cancer, or its precursor lesions, as well as all other cytologic categories as defined by the Bethesda System.

The ThinPrep 2000 System is significantly more effective than the conventional Pap smear for the detection of Low-grade Squamous Intraepithelial (LSIL) and more severe lesions in a variety of patient populations. Since the ThinPrep 5000 System is technologically similar to the ThinPrep 2000 System, we conclude that the ThinPrep 5000 is also significantly more effective than the conventional Pap smear for the detection of Low-grade Squamous Intraepithelial (LSIL) and more severe lesions in a variety of patient populations.

Specimen quality with the ThinPrep 2000 System is significantly improved over that of conventional Pap smear preparation in a variety of patient populations. Since the ThinPrep 5000 System is technologically similar to the ThinPrep 2000 System, we conclude that the specimen quality with the ThinPrep 5000 System is also significantly improved over that of conventional Pap smear preparation in a variety of patient populations.

## MATERIALS REQUIRED

---

### MATERIALS PROVIDED

#### ThinPrep 5000 Processor

- ThinPrep 5000 Processor Instrument
- ThinPrep 5000 Processor Operator's Manual
- Fixative baths with evaporation covers (3)
- Carousel (1)
- Waste bottle assembly - includes bottle, bottle cap, tubing set, fittings, waste filter
- Power cord
- Staining Racks (pkg of 10)
- Carousel cover (1)
- Absorbent pad for filter
- Absorbent pad for evaporative cover

## ThinPrep 5000 Processor with AutoLoader

- ThinPrep 5000 Processor with AutoLoader
- ThinPrep 5000 Processor with AutoLoader Operator's Manual
- Power cord
- System Accessory Kit
- Optional items (printer, LIS networking)

### MATERIALS REQUIRED BUT NOT PROVIDED

- Slide staining system and reagents
- Standard laboratory fixative
- Coverslips and mounting media
- ThinPrep microscope slides
- 20 ml PreservCyt® Solution vial
- ThinPrep® Pap Test Filter for Gynecologic Applications
- Cervical collection device

## STORAGE

---

- Store PreservCyt Solution between 15°C (59°F) and 30°C (86°F). Do not use beyond the expiration date printed on the container.
- Store PreservCyt Solution with cytologic sample intended for ThinPrep Pap testing between 15°C (59°F) and 30°C (86°F) for up to 6 weeks.
- Store PreservCyt Solution with cytologic sample intended for CT/NG testing using the Roche Diagnostics COBAS AMPLICOR CT/NG test between 4°C (39°F) and 25°C (77°F) for up to 6 weeks.

## BIBLIOGRAPHY

---

1. Solomon D., Davey D, Kurman R, Moriarty A, O'Connor D, Prey M, Raab S, Sherman M, Wilbur D, Wright T, Young N, for the Forum Group Members and the 2001 Bethesda Workshop. The 2001 Bethesda System Terminology for Reporting Results of Cervical Cancer. *JAMA*. 2002;287:2114-2119.
2. Jones HW. Impact of The Bethesda System, *Cancer* 77 pp. 1914-1918, 1995.
3. American Cancer Society. Cancer Facts and Figures, 1995.
4. Ashfaq R, Gibbons D, Vela C, Saboorian MH, Iliya F. ThinPrep Pap Test. Accuracy for glandular disease. *Acta Cytol* 1999; 43: 81-5
5. Bai H, Sung CJ, Steinhoff MM: ThinPrep Pap Test promotes detection of glandular lesions of the endocervix. *Diagn Cytopathol* 2000;23:19-22
6. Carpenter AB, Davey DD: ThinPrep Pap Test: Performance and biopsy follow-up un a university hospital. *Cancer Cytopathology* 1999; 87: 105-12
7. Guidos BJ, Selvaggi SM. Detection of endometrial adenocarcinoma with the ThinPrep Pap test. *Diagn Cytopathol* 2000; 23: 260-5
8. Schorge JO, Hossein Saboorian M, Hynan L, Ashfaq R. ThinPrep detection of cervical and endometrial adenocarcinoma: A retrospective cohort study. *Cancer Cytopathology* 2002; 96: 338-43
9. Wang N, Emancipator SN, Rose P, Rodriguez M, Abdul-Karim FW. Histologic follow-up of atypical endocervical cells. Liquid-based, thin-layer preparation vs. conventional Pap smear. *Acta Cytol* 2002; 46: 453-7

# TECHNICAL SERVICE AND PRODUCT INFORMATION

---

For technical service and assistance related to use of the ThinPrep 5000 System, contact Hologic:

Telephone: 1-800-442-9892

Fax: 1-508-229-2795

For international or toll-free blocked calls, please contact 1-508-263-2900.

Email: [info@hologic.com](mailto:info@hologic.com)



Hologic, Inc.  
250 Campus Drive  
Marlborough, MA 01752  
1-800-442-9892  
[www.hologic.com](http://www.hologic.com)



Hologic BVBA  
Da Vincilaan 5  
1930 Zaventem  
Belgium

Part No.AW-19074-001 Rev 002  
©2020 Hologic, Inc.. All rights reserved.  
10-2020



## Table of Contents

## Table of Contents



# *Table of Contents*

---

## *Chapter One*

### INTRODUCTION

<b>SECTION A:</b> Overview and Function of the ThinPrep® 5000 Processor .....	1.1
<b>SECTION B:</b> Technical Specifications .....	1.9
<b>SECTION C:</b> Internal Quality Control .....	1.12
<b>SECTION D:</b> ThinPrep 5000 Hazards .....	1.12
<b>SECTION E:</b> Disposal .....	1.17

## *Chapter Two*

### INSTALLATION

<b>SECTION A:</b> General .....	2.1
<b>SECTION B:</b> Action Upon Delivery .....	2.1
<b>SECTION C:</b> Preparation Prior to Installation .....	2.1
<b>SECTION D:</b> Moving the ThinPrep 5000 Processor .....	2.2
<b>SECTION E:</b> Storage and Handling Post Installation .....	2.3
<b>SECTION F:</b> Connect the Waste Bottle .....	2.3
<b>SECTION G:</b> Connect Power to the System .....	2.4
<b>SECTION H:</b> Turn on the ThinPrep 5000 Processor .....	2.4
<b>SECTION I:</b> Set User Preferences .....	2.5
<b>SECTION J:</b> Turn Off the ThinPrep 5000 Processor .....	2.6



## CONTENTS

### *Chapter Three*

#### **PRESERVCYT® AND CYTOLYT® SOLUTIONS**

<b>SECTION A:</b> PreservCyt Solution .....	3.1
<b>SECTION B:</b> CytoLyt Solution .....	3.5

### *Chapter Four*

#### **GYNECOLOGIC SAMPLE PREPARATION**

<b>SECTION A:</b> Gynecologic Specimen Preparation.....	4.1
<b>SECTION B:</b> Collection Preparation.....	4.2
<b>SECTION C:</b> Specimen Collection .....	4.3
<b>SECTION D:</b> Special Precautions .....	4.5
<b>SECTION E:</b> Sample Processing Troubleshooting.....	4.6

### *Chapter Five*

#### **NON-GYNECOLOGIC SAMPLE PREPARATION**

<b>SECTION A:</b> Introduction .....	5.1
<b>SECTION B:</b> Required Materials.....	5.2
<b>SECTION C:</b> Specimen Collection .....	5.3
<b>SECTION D:</b> General Steps for Sample Preparation .....	5.5
<b>SECTION E:</b> Specimen Preparation Guidelines .....	5.13
<b>SECTION F:</b> Sample Preparation Troubleshooting.....	5.22

### *Chapter Six*

#### **USER INTERFACE**

<b>SECTION A:</b> Main Screen, Processor Idle .....	6.2
<b>SECTION B:</b> Main Screen, During Processing .....	6.9
<b>SECTION C:</b> Baths Screen .....	6.13
<b>SECTION D:</b> Administrative Options .....	6.16



*Chapter Seven*

**OPERATING INSTRUCTIONS**

**SECTION A:** Introduction .....7.1  
**SECTION B:** Material Requirements .....7.1  
**SECTION C:** Labeling the Sample Vials and Slides .....7.3  
**SECTION D:** Load the ThinPrep 5000 Processor .....7.7  
**SECTION E:** Select the Sample Processing Sequence .....7.11  
**SECTION F:** Initiate a Batch .....7.12  
**SECTION G:** Processing Slides .....7.13  
**SECTION H:** Pause a Batch .....7.16  
**SECTION I:** Processing Complete .....7.17  
**SECTION J:** Unload the ThinPrep 5000 Processor .....7.18  
**SECTION K:** Optional Instructions for Ancillary Testing.....7.19

*Chapter Eight*

**MAINTENANCE**

**SECTION A:** Daily .....8.1  
**SECTION B:** Weekly Cleaning.....8.2  
**SECTION C:** Empty the Waste Bottle .....8.6  
**SECTION D:** Clean the Touch Screen .....8.10  
**SECTION E:** Clean Input Carousel and Dust Cover .....8.11  
**SECTION F:** Change Absorbent Pads .....8.12  
**SECTION G:** Remove and Clean Drip Trays .....8.13  
**SECTION H:** Replacing the User Accessible Fuses.....8.14

*Chapter Nine*

**TROUBLESHOOTING**

**SECTION A:** General.....9.1  
**SECTION B:** Sample Processing Errors.....9.1  
**SECTION C:** Batch Processing Errors.....9.10  
**SECTION D:** System Errors.....9.14



## CONTENTS

### *Chapter Ten*

#### STAINING AND COVERSIPPING

<b>SECTION A:</b> General.....	10.1
<b>SECTION B:</b> Fixation .....	10.1
<b>SECTION C:</b> Recommended Staining Guidelines .....	10.2
<b>SECTION D:</b> Coverslipping .....	10.4

### *Chapter Eleven*

#### THINPREP® PAP TEST TRAINING PROGRAM

<b>SECTION A:</b> Objective .....	11.1
<b>SECTION B:</b> Design .....	11.1
<b>SECTION C:</b> Bibliography .....	11.2

### *Chapter Twelve*

SERVICE INFORMATION	12.1
---------------------	------

### *Chapter Thirteen*

ORDERING INFORMATION	13.1
----------------------	------

#### INDEX



# Chapter One

---

## Introduction

### SECTION A

## OVERVIEW AND FUNCTION OF THE THINPREP® 5000 PROCESSOR

The ThinPrep® 5000 processor is used in the batch processing of liquid-based cytologic specimens to produce a thin, uniform preparation of cells that is transferred and fixed onto a glass microscope slide. The slide is delivered directly into a staining rack in an alcohol fixative bath. After processing, the slide is ready for staining, coverslipping and screening. The processor supports the preparation of:

- **Gynecologic specimens** for use with the ThinPrep Pap test, and subsequent imaging by the ThinPrep Imaging System, or samples for gynecologic cytology screening. One sample per vial may be processed in a batch.
- **Non-gynecologic specimens** collected for general cytologic screening. One sample per vial may be processed in a batch. An advanced program feature enables a batch in which 1 to 10 samples may be removed from the vial.
- **Urine specimens** used in conjunction with the ThinPrep UroCyte® Urine Collection Kit. One sample per vial may be processed in a batch.

Each batch may contain only one type of specimen (all gynecologic or all non-gynecologic or all UroCyte). The system accommodates up to 20 samples per batch.

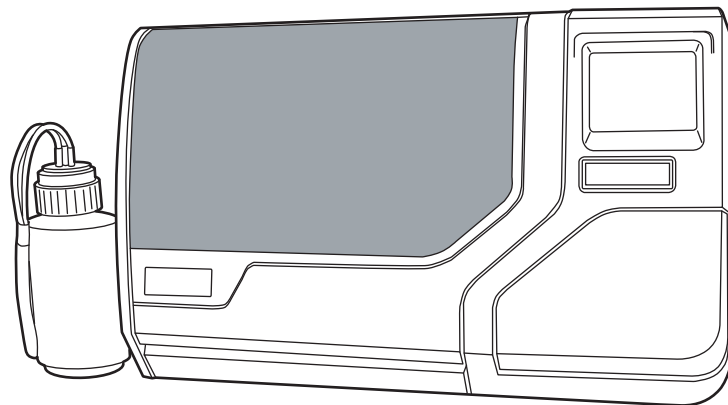

**Figure 1-1 A ThinPrep 5000 Processor**

**Note:** The instructions for using the ThinPrep 5000 processor are the same regardless of the instrument color.



## INTRODUCTION

### **Intended Use**

The ThinPrep® 5000 processor is intended as a replacement for the conventional method of Pap smear preparation for use in screening for the presence of atypical cells, cervical cancer, or its precursor lesions (Low Grade Squamous Intraepithelial Lesions, High Grade Squamous Intraepithelial Lesions), as well as all other cytologic categories as defined by The Bethesda System for Reporting Cervical/Vaginal Cytologic Diagnoses<sup>1</sup>. The ThinPrep 5000 processor is also intended for preparing and making slides with non-gynecologic (non-gyn) samples, including urine samples.

### **The ThinPrep® Pap Test**

The ThinPrep Pap test is a fluid-based method for the collection and preparation of gynecologic samples.

The ThinPrep Pap test begins at the physician's office where, using a broom-type collection device or endocervical brush/plastic spatula, cervical cells are collected from the patient. Rather than smearing the patient's sample directly onto a microscope slide, the collection device is immediately immersed and rinsed in a vial of PreservCyt Solution for use with the ThinPrep Pap test.

The sample vial is then capped and tightened. Patient information is recorded onto the vial of solution containing the sample and forwarded to a laboratory equipped to process the ThinPrep Pap test.

At the laboratory, matching barcoded labels are applied to the sample vial, microscope slide and accompanying test request form. The sample vial is then placed in a sample vial carousel and loaded into the ThinPrep 5000 processor.

(Refer to Figure 1-2.) During the slide preparation process, a gentle dispersion step breaks up blood, mucus and non-diagnostic debris and thoroughly mixes the cell sample. The cells are then collected onto a ThinPrep Pap test filter as a thin layer by creating a gentle vacuum and monitoring of the flow rate through the filter. The cells are then transferred to a ThinPrep microscope slide due to the natural adhesion properties of the cells, an electrochemical charge of the glass and a slight positive air pressure behind the filter membrane. The slide is delivered to a staining rack immersed in an alcohol fixative bath.

(For ancillary testing preparation and instructions, please refer to "OPTIONAL INSTRUCTIONS FOR ANCILLARY TESTING" on page 7.19.)

1. Nayar R, Wilbur DC. (eds). *The Bethesda System for Reporting Cervical Cytology: Definitions, Criteria, and Explanatory Notes*. 3rd ed. Cham, Switzerland: Springer: 2015



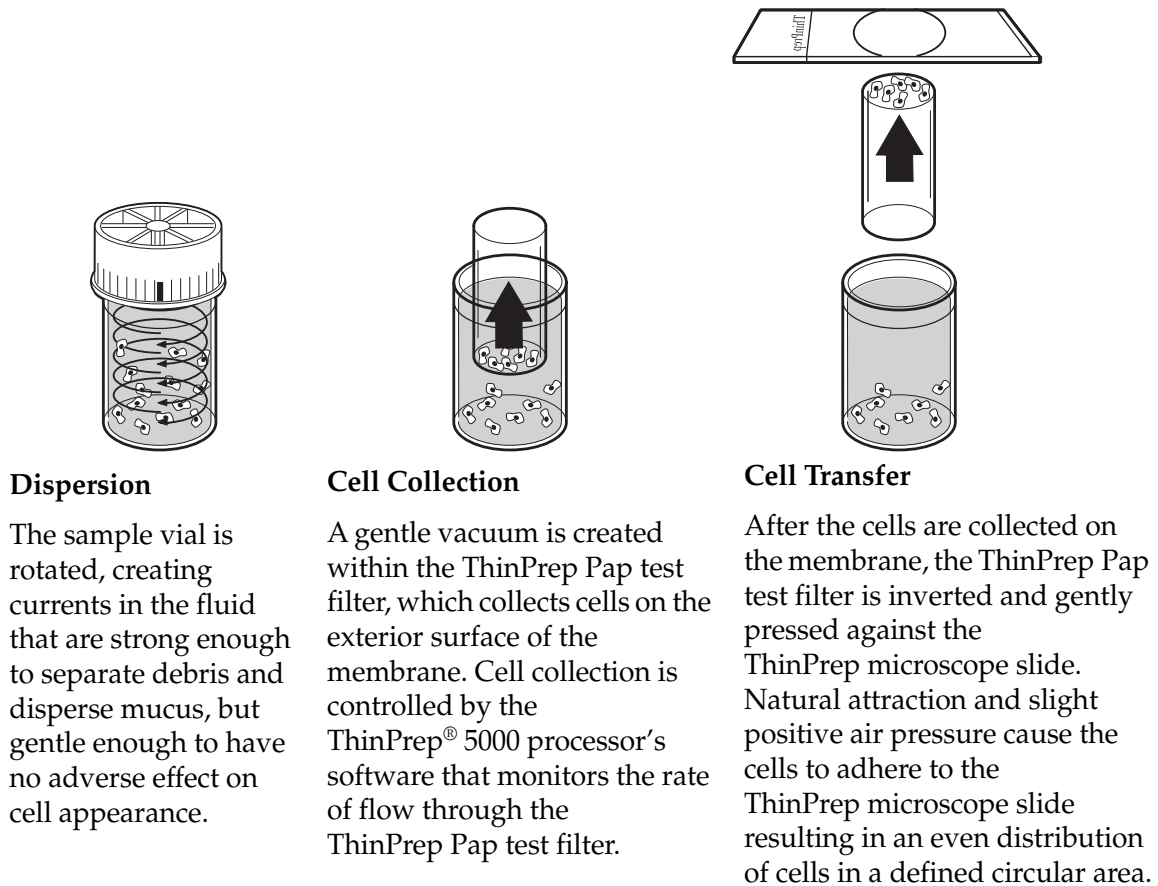

**Figure 1-2 The ThinPrep Sample Preparation Process**

## Limitations

- Gynecologic samples collected for preparation using the ThinPrep 5000 processor should be collected using a broom-type cervical collection device or endocervical brush/plastic spatula combination collection device. Refer to the instructions provided with the collection device for warnings, contraindications, and limitations associated with specimen collection.
- Preparation of microscope slides using the ThinPrep 5000 processor should be performed only by personnel who have been trained by Hologic or by organizations or individuals designated by Hologic.
- Evaluation of microscope slides produced with the ThinPrep 5000 processor should be performed only by cytotechnologists and pathologists who have been trained to evaluate ThinPrep-prepared slides by Hologic or by organizations or individuals designated by Hologic.



## INTRODUCTION

- Supplies used in the ThinPrep 5000 processor are those designed and supplied by Hologic specifically for the ThinPrep 5000 processor. These include PreservCyt Solution vials, ThinPrep Pap test filters, and ThinPrep microscope slides. These supplies are required for proper performance of the system and cannot be substituted. Product performance will be compromised if other supplies are used. After use, supplies should be disposed of in accordance with local, state, and federal regulations.
- A ThinPrep Pap test filter must be used only once and cannot be reused.
- The performance of HPV DNA and CT/NG testing on sample vials reprocessed with glacial acetic acid (GAA) has not been evaluated.

### Contraindications

- *Chlamydia trachomatis* and *Neisseria gonorrhoeae* testing using Hologic's APTIMA COMBO 2<sup>®</sup> CT/NG assay and the Roche Diagnostics COBAS AMPLICOR assay should not be performed on a sample that has already been processed using the ThinPrep 5000 processor.

### Warnings

- For *In Vitro* diagnostic use.
- Danger. PreservCyt Solution contains methanol. Toxic if swallowed. Toxic if inhaled. Causes damage to organs. Cannot be made non-poisonous. Consult Safety Data Sheet (SDS) at [www.hologicsds.com](http://www.hologicsds.com). Wear personal protective laboratory gear. Flammable liquid and vapor. Keep away from heat, sparks, open flames and hot surfaces. Evaporating alcohol could create a fire hazard. Other solutions cannot be substituted for PreservCyt Solution. PreservCyt Solution should be stored and disposed of in accordance with all applicable regulations.
- Strong oxidizers, such as bleach, are incompatible with PreservCyt Solution and therefore should not be used to clean the waste bottle.

### Precautions

- This equipment generates, uses, and can radiate radio frequency energy, and if not installed and used in accordance with the operator's manual, may cause interference to radio communications. Operation of this equipment in a residential area is likely to cause harmful interference, in which case the user will be required to correct the interference at his/her own expense.
- PreservCyt Solution *with* cytologic sample intended for ThinPrep Pap testing must be stored between 15°C (59°F) and 30°C (86°F) and tested within 6 weeks of collection.
- PreservCyt Solution *with* cytologic sample intended for CT/NG testing using the Roche Diagnostics COBAS AMPLICOR CT/NG test must be stored between 4°C (39°F) and 25°C (77°F) and tested within 6 weeks of collection.

- Always use the USB drive provided with the processor. Never use a U3 Smart Drive. While the system is able to write to this device, there is a significant problem if the system is booted with one of these drives inserted in a port. Field service would be required.
- Note also that the system cannot write data to a write-protected USB key.
- PreservCyt Solution was challenged with a variety of microbial and viral organisms. The following table presents the starting concentrations of viable organisms and the log reduction of viable organisms found after 15 minutes in the PreservCyt Solution. As with all laboratory procedures, universal precautions should be followed.

Organism	Initial Concentration	Log Reduction After 15 Minutes
<i>Candida albicans</i>	5.5 x 10 <sup>5</sup> CFU/ml	≥4.7
<i>Candida auris</i>	2.6 x 10 <sup>5</sup> CFU/ml	≥5.4
<i>Aspergillus niger</i>	4.8 x 10 <sup>5</sup> CFU/ml	2.7*
<i>Escherichia coli</i>	2.8 x 10 <sup>5</sup> CFU/ml	≥4.4
<i>Staphylococcus aureus</i>	2.3 x 10 <sup>5</sup> CFU/ml	≥4.4
<i>Pseudomonas aeruginosa</i>	2.5 x 10 <sup>5</sup> CFU/ml	≥4.4
<i>Mycobacterium tuberculosis</i> <sup>†</sup>	9.4 x 10 <sup>5</sup> CFU/ml	4.9**
Rabbitpox virus	6.0 x 10 <sup>6</sup> PFU/ml	5.5***
HIV-1	3.2 x 10 <sup>7</sup> TCID <sub>50</sub> /ml	≥7.0***
Hepatitis B virus <sup>†</sup>	2.2 x 10 <sup>6</sup> TCID <sub>50</sub> /ml	≥4.25
SARS-CoV-2 virus	1.8 x 10 <sup>6</sup> TCID <sub>50</sub> /ml	≥3.75
<p>* After 1 hour 4.7 log reduction  ** After 1 hour 5.7 log reduction  *** Data is for 5 minutes  † Organisms were tested with similar organisms from the same genus to assess antimicrobial effectiveness</p>		
<p><b>Note:</b> All log reduction values with a ≥ designation yielded undetectable microbial presence after exposure to PreservCyt Solution. The listed values represent the minimum allowable claim given the initial concentration and the detection limit of the quantitative method.</p>		

# 1

## INTRODUCTION

### Components

Key system components include the ThinPrep 5000 processor, PreservCyt® Solution sample vials, fixative baths, filters and microscope slides.

The system is operated via a touch screen graphic user interface. The interface is available in several languages, via a user preference.

All specimen samples are collected into PreservCyt Solution vials. The sample vial and a corresponding ThinPrep microscope slide are labeled with matching accession numbers and are loaded into a carousel for processing. A ThinPrep filter is also loaded for each sample. The carousel holds up to 20 samples per batch. Loading fewer than 20 samples is acceptable.

The carousel is placed into the ThinPrep 5000 processor. A fixative bath containing a staining rack and fixative alcohol is placed into the output compartment. The filter waste bin is emptied, if necessary.

Close the doors and select the type of sample to process and press Start. An optional system check before running the batch will identify vials present and confirm agreement of the vial and slide IDs.

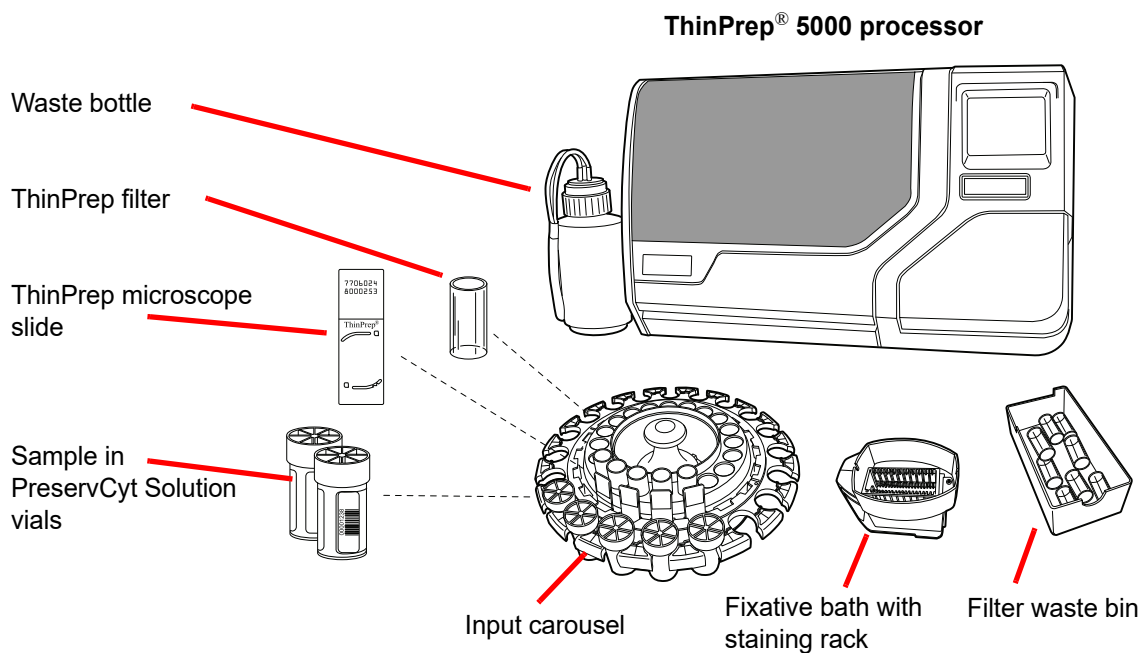

**Figure 1-3 ThinPrep 5000 Processor Components**

### Overview of Processing

For routine batch processing, the ThinPrep 5000 processor proceeds in this fashion once the batch is started:

- Check the vial and slide IDs
- Pick up a vial and filter

- Place the vial into the disperser
- Pick up the slide
- Tighten cap and disperse the vial contents
- Uncap the vial
- Place the slide on the cell transfer station (pneumatic suction holder)
- Introduce filter to vial, wet filter and test sufficiency of fluid level
- Collect cells
- Evacuate liquid waste
- Cell transfer from filter to slide
- Deposit slide into fixative bath
- Puncture and dispose of the filter
- Recap the vial
- Return the vial to the input carousel

### **Materials Provided**

The following items are included when the ThinPrep® 5000 processor is delivered for installation.

(These items may vary according to your order.)

- ThinPrep 5000 processor
- ThinPrep 5000 Processor Operator's Manual
- Power cord
- Waste bottle with tubing harness and transport cover
- Fixative baths with evaporation covers (3)
- Carousel (1)
- Carousel dust cover (1)
- Absorbent pads for the filter plug (4)
- Absorbent pads for the evaporation cover (4)
- Staining racks (package of 10)
- USB flash drive
- UPS (uninterruptible power supply)

### **Storage**

- Store PreservCyt® Solution between 15°C (59°F) and 30°C (86°F). Do not use beyond the expiration date printed on the container.



## INTRODUCTION

- Store PreservCyt Solution *with* cytologic sample intended for ThinPrep Pap testing between 15°C (59°F) and 30°C (86°F) for up to 6 weeks.
- Store PreservCyt Solution *with* cytologic sample intended for CT/NG testing using the Roche Diagnostics COBAS AMPLICOR CT/NG test between 4°C (39°F) and 25°C (77°F) for up to 6 weeks.

The storage requirements for all types of ThinPrep filters are:

- Store filters in their trays with the cover on until ready for use.
- Store the filters in an ambient environment and out of direct sunlight.
- Check the expiration date printed on the tray label and discard if outdated.

SECTION  
B

TECHNICAL SPECIFICATIONS

Overview of Components

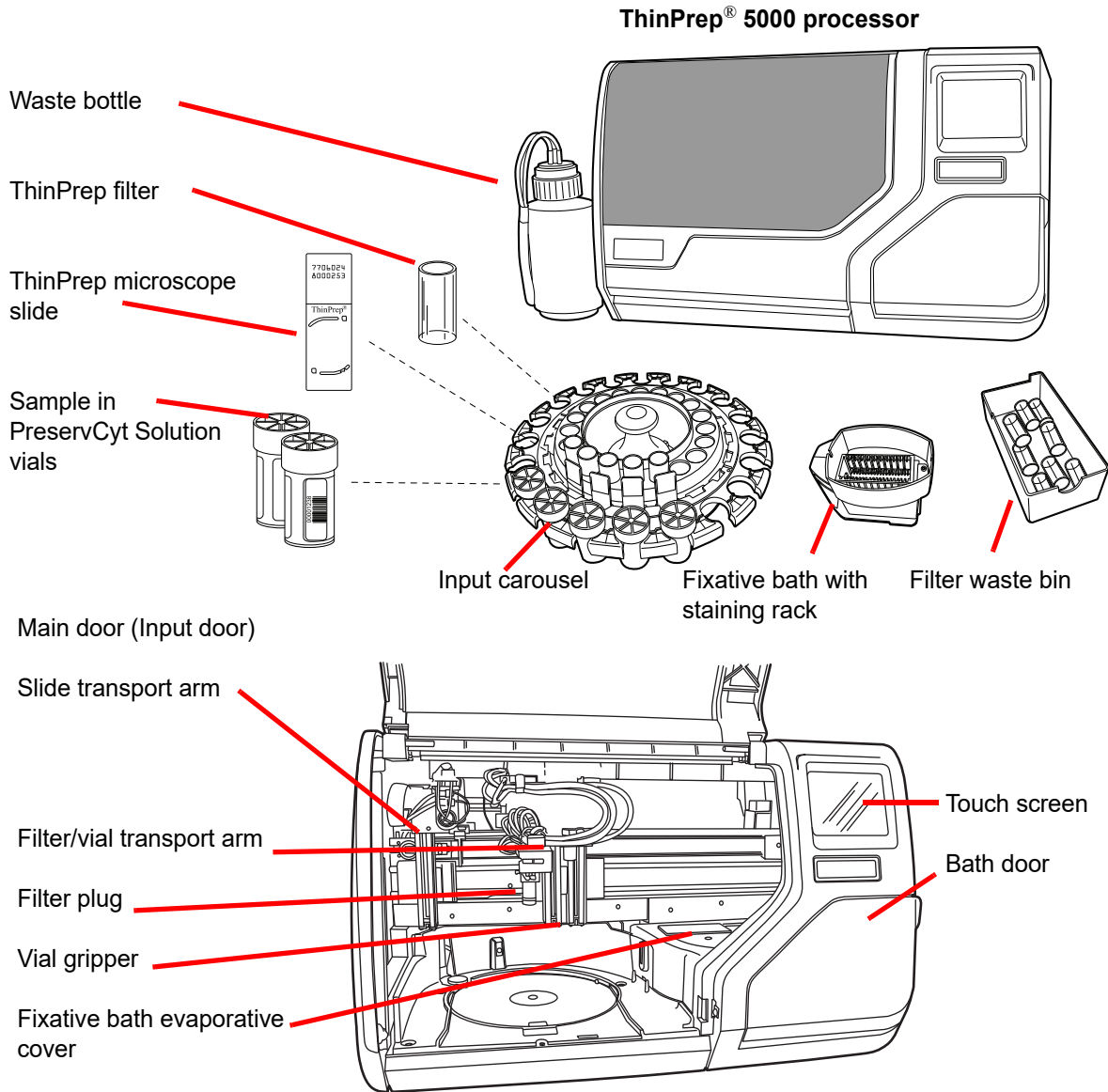

Figure 1-4 Overview of Components



## INTRODUCTION

### Dimensions and Weight (Approximate)

ThinPrep® 5000 processor: 22 inches (56 cm) high x 34 inches (86 cm) wide x 26 inches (66 cm) deep  
185 lbs/84 kg

Waste bottle: 17 inches (43 cm) high x 6 inches (15 cm) diameter

### Clearances

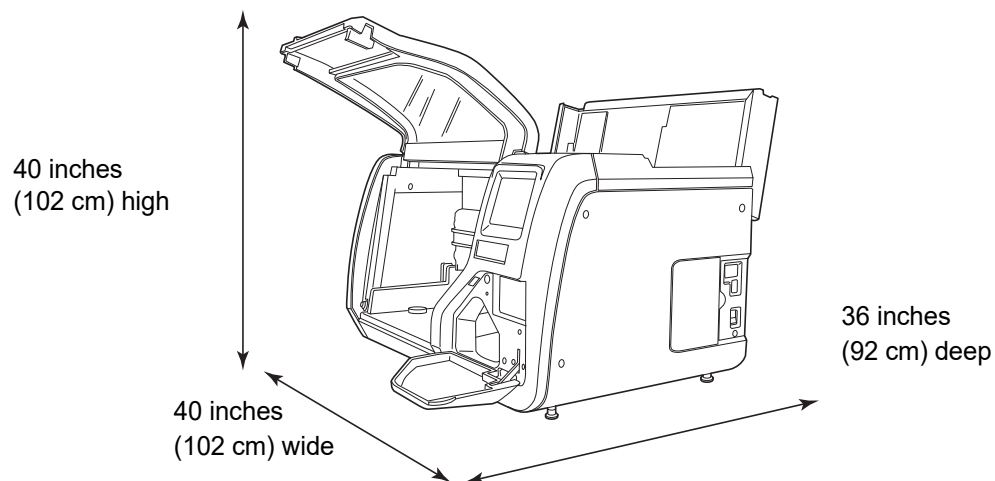

**Figure 1-5 ThinPrep 5000 Processor Clearances  
Shown with Top Service Lid Open**

### Environmental

#### Operating temperature

16–32°C

60–90°F

#### Operating humidity

20%–80% RH, non-condensing

#### Non-operating temperature

-28°C–50°C

-20°F–122°F

#### Non-operating humidity

15%–95% RH, non-condensing

#### Sound levels

68.2 dBA maximum at normal operator's position



70.4 dBA maximum at bystander's position

**Heat load**

Maximum 315 Watts =1075 BTU/hr or 1,134 kJ/hr

**Power****Electrical voltage**

100 - 130 VAC at 2.1 amps

220 - 240 VAC at 1 amp

**Frequency power**

50–60 Hz

Maximum 240 watts (= 819 BTUs/hour = 864 joules/hour)

**Fusing**

Two 15A/250V 3 AB SLO-BLO

**Connections to external circuits**

The external connections on the ThinPrep<sup>®</sup> 5000 processor are PELV (Protected Extra Low Voltage) as defined by IEC 61140. Outputs of other devices connected to the processor should also be PELV or SELV (Separated Extra Low Voltage). Only devices approved for safety by an appropriate agency should be connected to the ThinPrep 5000 processor.

**Safety, EMI and EMC Standards**

The ThinPrep 5000 processor has been tested and certified by a U.S. nationally recognized testing Laboratory (NRTL) to comply with current Safety, Electro-Magnetic Interference (EMI) and Electro-Magnetic Compatibility (EMC) standards. Refer to the model/rating label, located on the rear of the instrument, to see the safety certification markings (see Figure 1-7). This equipment meets the IEC 61010-2-101 particular safety requirements for IVD equipment.

This equipment meets the emission and immunity requirements of IEC 61326-2-6. This equipment has been tested and found to comply to CISPR 11 Class A emission limits.

In a domestic environment it may cause radio interference, in which case, you may need to take measures to mitigate the interference. The electromagnetic environment should be evaluated prior to operation of the equipment. Do not use this device in close proximity to sources of strong electromagnetic radiation (e.g., unshielded RF sources), as these may interfere with the proper operation.

This product is *in vitro* diagnostic (IVD) medical equipment.

If this equipment is used in a manner not specified by the manufacturer, then the protection provided by the equipment may be impaired.

# 1

## INTRODUCTION

### SECTION C

## INTERNAL QUALITY CONTROL

### Power On Self-Test (POST)

When the ThinPrep® 5000 processor is powered on (refer to page 2.4), the system goes through a self-diagnostic test. The electrical, mechanical and software/communications subsystems are tested to confirm that each performs properly. The operator is alerted to malfunctions by a message on the touch screen interface and by audible sound (if enabled).

### SECTION D

## THINPREP 5000 HAZARDS

The ThinPrep 5000 processor is intended to be operated in the manner specified in this manual. Be sure to review and understand the information listed below in order to avoid harm to operators and/or damage to the instrument.

If this equipment is used in a manner not specified by the manufacturer, then the protection provided by the equipment may be impaired.

### Warnings, Cautions and Notes

The terms **WARNING**, **CAUTION** and **Note** have specific meanings in this manual.







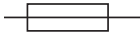

A **WARNING** advises against certain actions or situations that could result in personal injury or death.

A **CAUTION** advises against actions or situations that could damage equipment, produce inaccurate data or invalidate a procedure, although personal injury is unlikely.

A **Note** provides useful information within the context of the instructions being provided.



## Symbols Used on the Instrument

The following symbols are used on this instrument::

	Attention, refer to accompanying documents
	Fuse
	Waste Electrical and Electronic Equipment. <b>Do not dispose in municipal waste.</b> Contact Hologic for disposal of the instrument.
	<i>In Vitro</i> diagnostic medical device
	Laser device (internal to the laser and not accessible to the operator)
	Authorized representative in the European Community
	Manufacturer
	Date of manufacture
	Catalogue number

# 1

## INTRODUCTION

SN	Serial number
	Protective Conductor Terminal
	Power Switch On
	Power Switch Off

**Figure 1-6 Symbols**

### Location of Labels on the Instrument

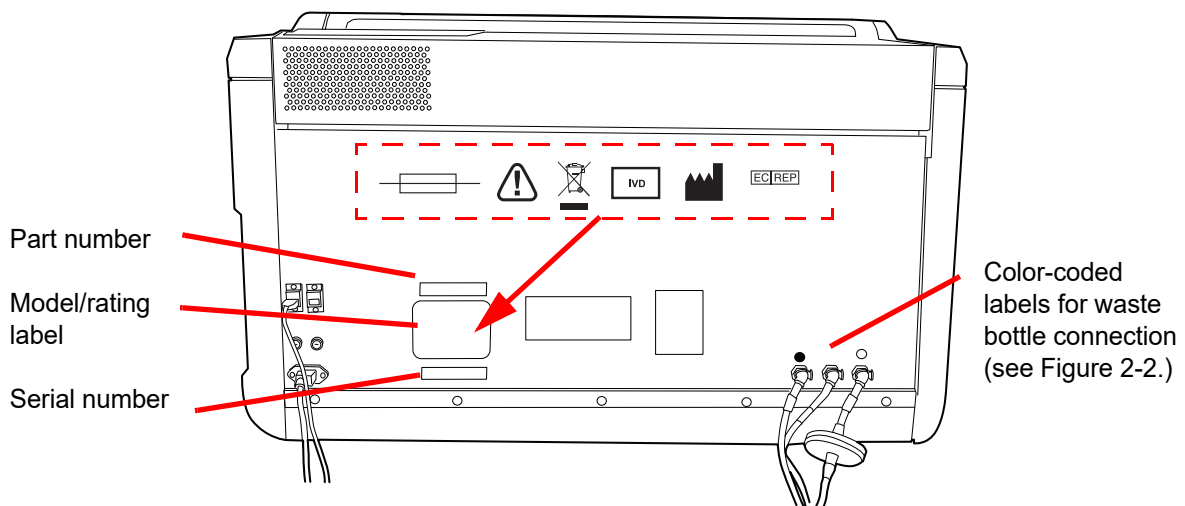

**Figure 1-7 Rear of the ThinPrep® 5000 Processor**

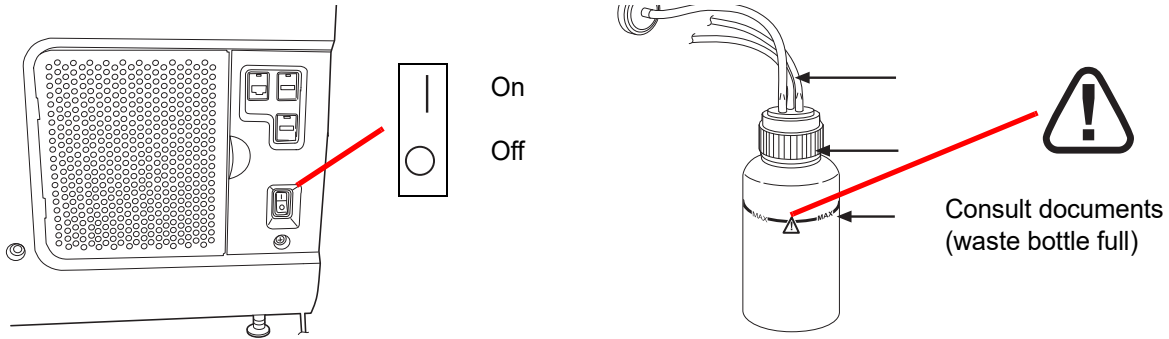

**Figure 1-8 Right Side of Processor and Waste Bottle**

## Warnings Used in this Manual:

### **WARNING**

#### **Service Installation Only**

This system is to be installed by trained Hologic personnel only.

### **WARNING**

#### **Moving Parts**

The processor contains moving parts. Keep hands, hair, loose clothing, jewelry, etc., clear. Do not operate with the doors open.

### **WARNING**

#### **Grounded Outlet**

To ensure safe operation of the equipment, use a three-wire grounded outlet. Disconnection from the power source is by removal of the power cord.

### **WARNING**

#### **Toxic Mixtures**

Danger. PreservCyt<sup>®</sup> Solution contains methanol. Toxic if swallowed. Toxic if inhaled. Causes damage to organs. Cannot be made non-poisonous. Keep away from heat, sparks, open flames and hot surfaces. Other solutions cannot be substituted for PreservCyt Solution.



## INTRODUCTION

Danger. CytoLyt<sup>®</sup> Solution contains methanol. Harmful if swallowed. Harmful if inhaled. Causes damage to organs. Cannot be made non-poisonous. Keep away from heat, sparks, open flames and hot surfaces. Other solutions cannot be substituted for CytoLyt Solution.

Follow the manufacturer's recommendations for reagent handling and cleanup of spills. Refer to manufacturer's SDS for more information. Wear protective laboratory gear.

### **WARNING**

#### **Flammable Liquid and Vapor**

Flammable liquids. Keep away from heat, sparks, open flames and hot surfaces.

### **WARNING**

#### **Glass**

The instrument uses microscope slides, which have sharp edges. In addition, the slides may be broken in their storage packaging or on the instrument. Use caution when handling glass slides and cleaning the instrument.

### **WARNING**

#### **Instrument Fusing**

For continued protection against fire, replace only with fuses of the specified type and current rating. Refer to the Maintenance chapter for instructions on replacing user accessible fuses. Refer to Ordering Information for fuse specification and ordering.

### **WARNING**

Do not process a cerebrospinal fluid (CSF) specimen or other sample type that is suspected of possessing prion infectivity (PrPsc) derived from a person with a TSE, such as Creutzfeldt-Jakob disease, on a ThinPrep processor. A TSE-contaminated processor cannot be effectively decontaminated and therefore must be properly disposed of in order to avoid potential harm to users of the processor or service personnel.

## SECTION

## E

## DISPOSAL

**Disposal of Consumable Items**

**CAUTION:** All disposables are for single use only and should not be reused.

- **PreservCyt® Solution.** Follow local, state, provincial and federal or county guidelines. Dispose of all solvents as hazardous waste.
- **CytoLyt® Solution.** Dispose of as a biohazard.
- **Fixative Reagent.** Follow local, state, provincial and federal or county guidelines. Dispose of all solvents as hazardous waste.
- **Used ThinPrep® Filters.** Dispose of as regular waste.
- **Waste Bottle contents.** Dispose of all solvents as hazardous waste. Follow local, state, provincial and federal or county guidelines. As with all laboratory procedures, universal precautions should be followed.
- **Absorbent Pads** for fixative bath evaporation cover and filter arm. Dispose of as regular waste. (If dripping wet, dispose of as hazardous waste.)
- **Broken Glass.** Dispose of in a Sharps container.



## INTRODUCTION

### **Disposal of the Device**

**Do not dispose in municipal waste.**

Please contact Hologic Technical Support.

Hologic will provide for the collection and proper reclamation of electrical devices we provide to our customers. Hologic strives to reuse Hologic devices, subassemblies, and components whenever possible. When reuse is not appropriate, Hologic will ensure the waste material is properly disposed of.



Hologic, Inc.  
250 Campus Drive  
Marlborough, MA 01752 USA  
Tel: 1-800-442-9892  
1-508-263-2900  
Fax: 1-508-229-2795  
Web: [www.hologic.com](http://www.hologic.com)

### **Safety Data Sheet**

CytoLyt Solution; PreservCyt Solution:

The Safety Data Sheet (SDS) for these solutions may be requested from Hologic Technical Support, or found online at [www.hologicsds.com](http://www.hologicsds.com).

For other reagents, refer to the manufacturer's SDS.





# Chapter Two

---

## Installation

**WARNING:** Service Installation Only

### SECTION A

#### GENERAL

The ThinPrep<sup>®</sup> 5000 processor must be installed by personnel who have completed Hologic service training for the processor. When installation is complete, the operator(s) are trained, using the operator's manual as the training guide.

### SECTION B

#### ACTION UPON DELIVERY

Remove and read the *Operating Instructions Prior to Installation* sheet attached to the packing carton.

Inspect the packing cartons for damage. Report any damage immediately to the shipper and/or Hologic Technical Support as soon as possible. (Refer to Chapter 12, Service Information.)

Leave the instrument in the packing cartons for Hologic service installation.

Store the instrument in a suitable environment until installation (cool, dry, vibration-free area).

### SECTION C

#### PREPARATION PRIOR TO INSTALLATION

##### **Pre-Installation Site Assessment**

A pre-installation site assessment is performed by Hologic service personnel. Be sure to have prepared any and all site configuration requirements as instructed by the service personnel.

##### **Location**

Locate the ThinPrep 5000 processor near (within 3 meters) a three-wire grounded power outlet that is free of voltage fluctuations and power surges. The processor will be connected to a UPS (uninterruptible power supply), which will be plugged into the electrical outlet. Refer to Figure 1-5 to ensure that there is sufficient clearance around the processor and includes room for the external

# 2

## INSTALLATION

waste bottle. If the processor will be configured with an optional printer and router, they may be plugged into the UPS. The components of the ThinPrep® 5000 processor should be close enough to comfortably make all connections.

During operation the ThinPrep 5000 processor is sensitive to vibrations. It should be placed on a flat, sturdy surface that can support the 185 lbs (84 kg) that it weighs. It should be placed away from any vibrating equipment.

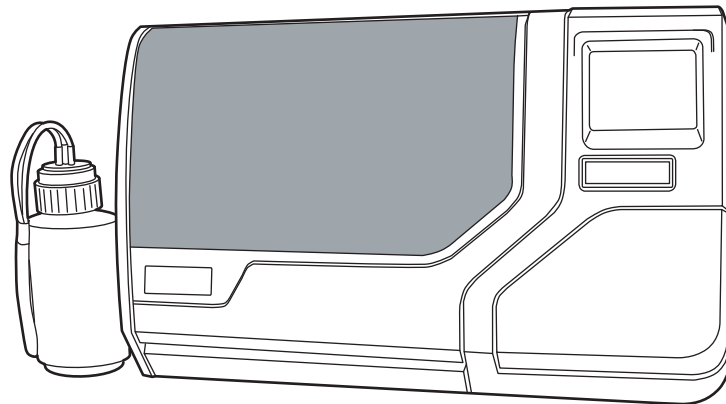

**Figure 2-1 A Typical ThinPrep 5000 Processor**

**CAUTION:** Route all connectors carefully to avoid pinching the cables. To avoid tripping over or disconnecting cabling, do not place cabling near foot traffic.

### SECTION D

## MOVING THE THINPREP 5000 PROCESSOR

**CAUTION:** The processor weighs 185 lbs (84 kg) and should always be moved by at least two people.

The ThinPrep 5000 processor is a precision instrument and should be handled with care. Prior to relocating the equipment, unload any items which may spill or break: carousel, sample vials, slides, filters, fixative baths. Vent, remove and cap the waste bottle with its transport cover (page 8.6).

If the processor must be moved, it should be grasped and lifted by the bottom of the housing. There are two contoured handhold areas along the right and left undersides of the processor housing especially for lifting the instrument.

If the ThinPrep 5000 processor is to be shipped to a new location, please contact Hologic Technical Support. (Refer to Chapter 12, Service Information.)

SECTION  
E

## STORAGE AND HANDLING POST INSTALLATION

The ThinPrep® 5000 processor may be stored where it is installed. Be sure to clean and maintain the instrument as described in the Maintenance chapter of this manual.

SECTION  
F

## CONNECT THE WASTE BOTTLE

**CAUTION:** At no time should bleach be present in the waste bottle while it is connected to the ThinPrep 5000 processor.

1. The waste bottle should be placed at the same height or below the ThinPrep 5000 processor. Do not place the waste bottle above the instrument.
2. Ensure that the waste bottle cap is tightly secured. The waste bottle must rest in an upright position. Do not allow the waste bottle to lay on its side.
3. Locate the three waste bottle connections at the rear of the ThinPrep 5000 processor. Refer to Figure 2-2. Ensure that the buttons of the connectors are in the down/inward position.

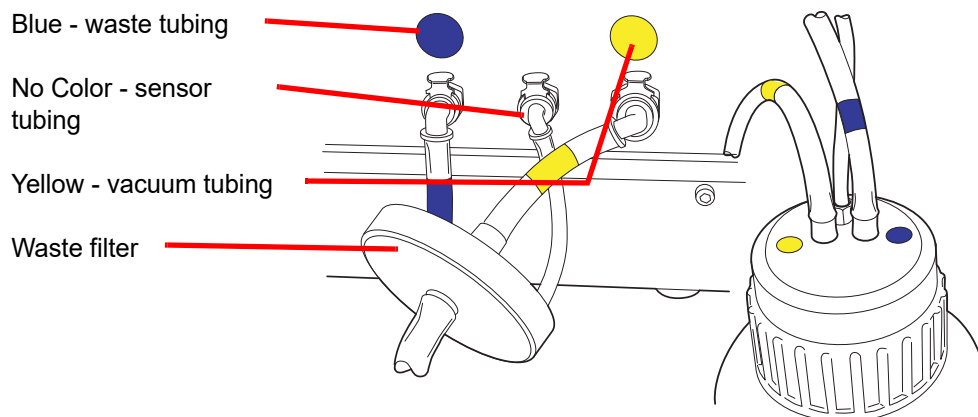

**Figure 2-2 Waste Bottle Tubing Connections**

4. Connect the color-coded waste tubing connectors to the corresponding connectors located in the rear of the instrument. When the proper connection has been established, the buttons on the connectors pop up/outward with a click sound. The L-shaped connector should be pointed downward.
  - Yellow = vacuum
  - Blue = waste
  - No Color = pressure sensor

# 2

## INSTALLATION

**CAUTION:** Do not mismatch tubing connections. This may result in damage to your processor.

**CAUTION:** Check the level of the waste every day. Always empty the waste bottle before it reaches the maximum liquid level line. Empty the waste bottle by following the procedure in “EMPTY THE WASTE BOTTLE” on page 8.6.

### SECTION G

## CONNECT POWER TO THE SYSTEM

All power cords must be plugged into a grounded outlet. Disconnection from the power supply source is by removal of the power cord.

Make sure the power switch is off. Then insert the power cord into the receptacle on the rear of the instrument (Figure 2-3). The processor comes with a UPS (uninterruptible power supply). The instrument’s power cord is plugged into the UPS. Plug the UPS power cord into a grounded outlet.

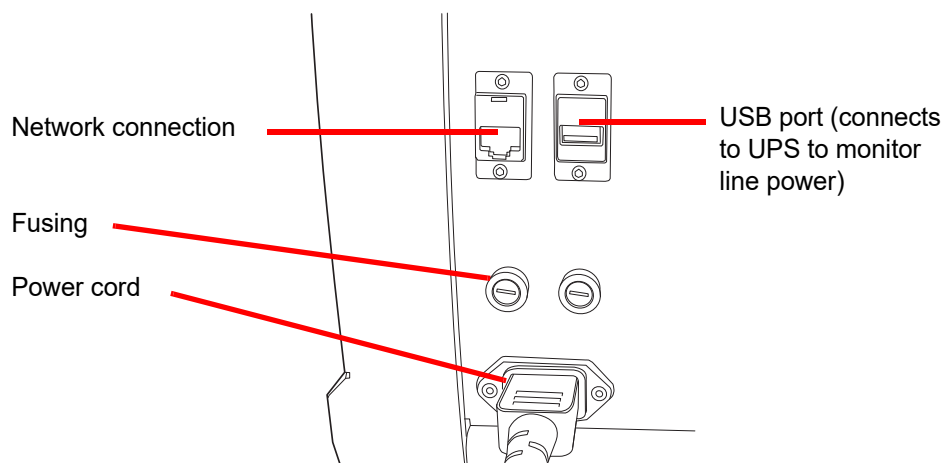

**Figure 2-3 Rear of ThinPrep® 5000 Processor**

### SECTION H

## TURN ON THE THINPREP 5000 PROCESSOR

**CAUTION:** Do not power on the processor while a USB key is in any of the USB ports. See Figure 2-3 and Figure 2-4 for USB port locations.

Both doors must be closed prior to turning on the processor.

Press the rocker switch located on the lower right side of the processor to the on position. See Figure 2-4.

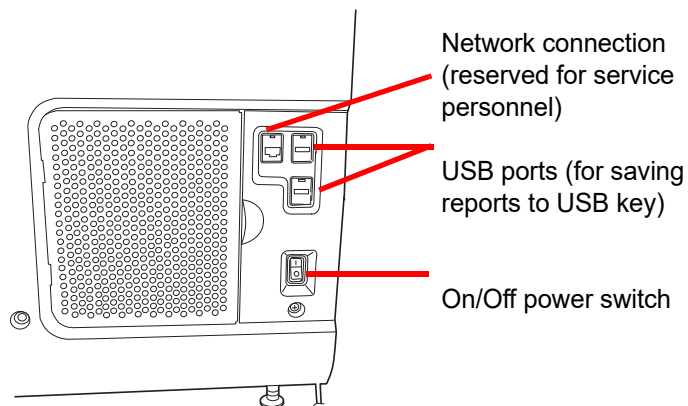

**Figure 2-4 Power Switch**

The user interface will display the ThinPrep® 5000 processor logo while the system boots and the main screen will appear when the processor is ready for use. The pump/compressor will be heard to energize and the mechanisms will move and then position for access. The doors will unlock.

**Note:** The ThinPrep 5000 processor is intended to be left on. For shutdown or extended shutdown, see page 2.6.

SECTION  
I

## SET USER PREFERENCES

The following preferences may be set via the touch screen interface. These settings may be reset at any time and any settings will persist even if the processor is powered off and powered on again.

- Set Time And Date - page 6.19.
- Set Lab Name - page 6.21
- Set Processor Name - page 6.22
- Set Language - page 6.25
- Set Audible Sound - page 6.23
- Printer - page 6.27

# 2

## INSTALLATION

### SECTION J

## TURN OFF THE THINPREP 5000 PROCESSOR

### Normal Shutdown

**CAUTION:** Never turn off power to the instrument without first quitting the application via the user interface.

If the instrument is to be turned off, it must be in an idle state. If a batch is in progress, either let it finish, or stop the batch. To shut down, touch the **Admin Options** button on the user interface and press the **Shutdown** button.



**Figure 2-5 Shutdown Button**

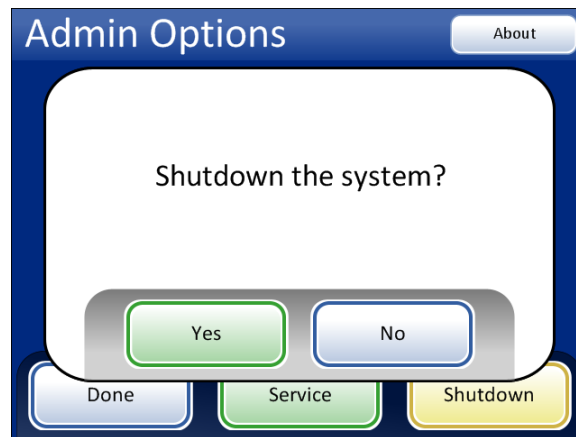

**Figure 2-6 Shutdown Confirmation**

A confirmation box will be displayed on the touch screen. Press the **Yes** button to proceed with system shutdown. Wait for the application to turn off (wait until the touch screen interface goes blank). Then turn off the power switch located on the right side of the instrument.

Press the **No** button to cancel shutdown and return to the Admin Options screen.

### Extended Shutdown

If the instrument is to be shut down for an extended amount of time, or be taken out of service, empty the waste bottle (Maintenance chapter), remove any items that may be on board and close all doors. Follow the instructions for Normal Shutdown. Completely remove power to the instrument by unplugging the power cord from the wall outlet.





# Chapter Three

---

## PreservCyt® & CytoLyt® Solutions

### SECTION A

### PRESERVCYT SOLUTION

The following sections describe the function and specifications of the cytologic preservative fluid, PreservCyt® Solution.

PreservCyt Solution is a methanol-based, buffered solution designed to preserve cells during transport and slide preparation on the ThinPrep® 5000 processor.

The slide preparation process on the ThinPrep processor also requires PreservCyt Solution for transporting and storing samples prior to processing. PreservCyt Solution is optimized for the ThinPrep processor slide preparation process and cannot be substituted with any other reagents.

### Packaging

Please refer to the Ordering Information in this manual for part numbers and detailed information regarding the ordering of solutions and supplies for the ThinPrep 5000 processor.

- Vials (20 mL) of PreservCyt Solution are contained in each ThinPrep Pap test.

### Composition

PreservCyt Solution is a buffered solution containing methanol. It contains no reactive ingredients. It contains no active ingredients.

**WARNING:** Danger. PreservCyt Solution contains methanol. Toxic if swallowed. Toxic if inhaled. Causes damage to organs. Cannot be made non-poisonous. Keep away from heat, sparks, open flames and hot surfaces. Other solutions cannot be substituted for PreservCyt Solution.

### Storage Requirements

- Store PreservCyt Solution between 15°C (59°F) and 30°C (86°F). Do not use beyond the expiration date printed on the container.
- Store PreservCyt Solution *with* cytologic sample intended for ThinPrep Pap testing between 15°C (59°F) and 30°C (86°F) for up to 6 weeks.
- Store PreservCyt Solution *with* cytologic sample intended for CT/NG testing using the Roche Diagnostics COBAS AMPLICOR CT/NG test between 4°C (39°F) and 25°C (77°F) for up to 6 weeks.

# 3

## PRESERVCYT® & CYTOLYT® SOLUTIONS

**Note:** Refer to “OPTIONAL INSTRUCTIONS FOR ANCILLARY TESTING” on page 7.19 for instructions for aliquot removal for ancillary testing prior to running the ThinPrep Pap test.

- Storage requirements for quantities of PreservCyt® Solution are dependent on local regulations regarding the size and configuration of your facility. Please refer to the Solutions Storage Guide at the end of this chapter.

### Transportation

When transporting a PreservCyt Solution vial containing cells, make sure the vial is tightly sealed. Align the mark on the cap with the mark on the vial as shown in Figure 3-1 to prevent leakage. If the cap on the vial does not have a torque line, ensure the cap is tightened securely.

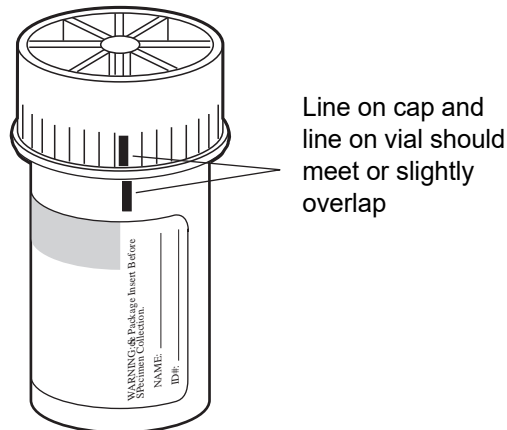

**Figure 3-1 Aligning the Vial Cap**

The shipping category for PreservCyt Solution is:

“flammable liquids, n.o.s. (methanol)” (USA only)

“flammable liquids, toxic, n.o.s. (methanol)” (outside the USA)

The shipping category for PreservCyt Solution containing cells is “diagnostic sample.”

Please refer to the Shipping Requirements and Recommendations guide at the end of this chapter.

### Stability

Do not use PreservCyt Solution after the expiration date on the container label. If making multiple slides from the same sample vial, be sure to make the slides before the expiration date marked on the sample vial. Expired vials should be discarded using appropriate laboratory procedures. Also, refer to the Storage Requirements earlier in this section for cell preservation limits.

## Handling/Disposal

Handle all chemical-containing materials carefully in accordance with safe laboratory practices. When required by reagent composition, additional precautions are marked on the reagent containers or in the instructions for use.

Dispose of PreservCyt® Solution according to the guidelines for disposing of hazardous waste. PreservCyt Solution contains methanol.

- PreservCyt Solution was challenged with a variety of microbial and viral organisms. The following table presents the starting concentrations of viable organisms and the log reduction of viable organisms found after 15 minutes in the PreservCyt Solution. As with all laboratory procedures, universal precautions should be followed.

Organism	Initial Concentration	Log Reduction After 15 Minutes
<i>Candida albicans</i>	5.5 x 10 <sup>5</sup> CFU/ml	≥4.7
<i>Candida auris</i>	2.6 x 10 <sup>5</sup> CFU/ml	≥5.4
<i>Aspergillus niger</i>	4.8 x 10 <sup>5</sup> CFU/ml	2.7*
<i>Escherichia coli</i>	2.8 x 10 <sup>5</sup> CFU/ml	≥4.4
<i>Staphylococcus aureus</i>	2.3 x 10 <sup>5</sup> CFU/ml	≥4.4
<i>Pseudomonas aeruginosa</i>	2.5 x 10 <sup>5</sup> CFU/ml	≥4.4
<i>Mycobacterium tuberculosis</i> <sup>†</sup>	9.4 x 10 <sup>5</sup> CFU/ml	4.9**
Rabbitpox virus	6.0 x 10 <sup>6</sup> PFU/ml	5.5***
HIV-1	3.2 x 10 <sup>7</sup> TCID <sub>50</sub> /ml	≥7.0***
Hepatitis B virus <sup>†</sup>	2.2 x 10 <sup>6</sup> TCID <sub>50</sub> /ml	≥4.25
SARS-CoV-2 virus	1.8 x 10 <sup>6</sup> TCID <sub>50</sub> /ml	≥3.75
* After 1 hour 4.7 log reduction ** After 1 hour 5.7 log reduction *** Data is for 5 minutes † Organisms were tested with similar organisms from the same genus to assess antimicrobial effectiveness		
<b>Note:</b> All log reduction values with a ≥ designation yielded undetectable microbial presence after exposure to PreservCyt Solution. The listed values represent the minimum allowable claim given the initial concentration and the detection limit of the quantitative method.		



PRESERV<sup>®</sup>CYT & CYTO<sup>®</sup>LYT SOLUTIONS

### **Safety Data Sheet**

The SDS for PreservCyt Solution is included in the packaging of the product. It may also be accessed at [www.hologicsds.com](http://www.hologicsds.com).

SECTION  
BCYTOLYT<sup>®</sup> SOLUTION

CytoLyt Solution is a methanol-based, buffered, preservative solution designed to lyse red blood cells, prevent protein precipitation, dissolve mucus, and preserve morphology of general cytology samples. It is intended as a transportation medium and is used in specimen preparation prior to processing. It is not intended for complete inactivation of microbes. Chapter 5, Non-Gynecologic Sample Preparation, describes the uses of CytoLyt Solution in detail.

**Packaging**

Please refer to the Ordering Information in this manual for part numbers and detailed information regarding the ordering of solutions and supplies for the ThinPrep<sup>®</sup> 5000 processor.

**Composition**

CytoLyt Solution contains methanol and buffer.

**WARNING:** Danger. CytoLyt Solution contains methanol. Harmful if swallowed. Harmful if inhaled. Causes damage to organs. Cannot be made non-poisonous. Keep away from heat, sparks, open flames and hot surfaces. Other solutions cannot be substituted for CytoLyt Solution.

**Storage Requirements**

- Store the containers at 15°C– 30°C without cells.
- Cells in CytoLyt Solution are preserved for 8 days at room temperature; however, for best results, transport specimen to the laboratory immediately for processing. This 8-day preservation period pertains to samples in a minimum CytoLyt Solution-to-sample ratio of one part CytoLyt Solution to three parts sample.
- Storage requirements for quantities of CytoLyt Solution are dependent on local regulations regarding the size and configuration of your facility. Please refer to the Solution Storage Guide at the end of this chapter.

**Transportation**

Make sure the tubes and specimen cups containing CytoLyt Solution are tightly sealed. Align the mark on the cap with the mark on the vial to prevent leakage.

**Stability**

Do not use CytoLyt Solution after the expiration date on the container label. Refer to the Storage Requirements earlier in this section for cell preservation limits.



PRESERV<sup>®</sup>CYT<sup>®</sup> & CYTO<sup>®</sup>LYT<sup>®</sup> SOLUTIONS

### **Handling/Disposal**

Handle all chemical-containing materials carefully in accordance with safe laboratory practices.

### **Safety Data Sheet**

The SDS for CytoLyt Solution is included in the packaging of the product. It may also be accessed at [www.hologicsds.com](http://www.hologicsds.com).

The National Fire Protection Association (NFPA) is the expert authority that local fire departments and fire safety code enforcement authorities look to for fire safety standards and codes. Their codes are developed through a consensus standards development process approved by the American National Standards Institute. The NFPA codes are used as guidelines by most fire code enforcement agencies. Since these codes are guidelines, your local Authority Having Jurisdiction (AHJ) for fire code enforcement may make the final determination. The summary chart below is based upon guidelines for facilities protected by standard sprinkler systems. <sup>(3)</sup>

The ThinPrep products NFPA ratings are listed in a table below this chart.

Use this chart to help you determine your maximum storage limits for flammable and combustible liquids.

<b>Maximum Quantities of Flammable and Combustible Liquids in Laboratory Units Outside of Inside Liquid Storage Areas<sup>(4)</sup></b>														
Lab Unit Fire Hazard Class	Flammable & Combustible Liquid Class	NFPA Code	Quantities in Use						Quantities in Use and Storage					
			Max per 100ft <sup>2</sup> (9.2m <sup>2</sup> ) of Lab Unit <sup>(5)</sup>			Max Quantity per Lab Unit			Max per 100ft <sup>2</sup> (9.2m <sup>2</sup> ) of Lab Unit <sup>(5)</sup>			Max Quantity per Lab Unit		
			Gallons	Liters	Vials <sup>(8)</sup>	Gallons	Liters	Vials <sup>(8)</sup>	Gallons	Liters	Vials <sup>(8)</sup>	Gallons	Liters	Vials <sup>(8)</sup>
<b>A (High)</b>	I	45-2015	10	38	1900	480	1820	91,000	20	76	3800	480	1820	91,000
	I, II, IIIA	45-2015	20	76	3800	800	3028	151,400	40	150	7500	1600	6060	303,000
<b>B<sup>(6)</sup> (Moderate)</b>	I	45-2015	5	19	950	300	1136	56,800	10	38	1900	480	1820	91,000
	I, II, IIIA	45-2015	10	38	1900	400	1515	75,750	20	76	3800	800	3028	151,400
<b>C<sup>(7)</sup> (Low)</b>	I	45-2015	2	7.5	375	150	570	28,500	4	15	750	300	1136	56,800
	I, II, IIIA	45-2015	4	15	750	200	757	37,8520	8	30	1500	400	1515	75,750
<b>D<sup>(7)</sup> (Minimal)</b>	I	45-2015	1	4	200	75	284	14,200	2	7.5	375	150	570	28,500
	I, II, IIIA	45-2015	1	4	200	75	284	14,200	2	7.5	375	150	570	28,500

<b>Maximum Quantities of PreservCyt Solution (Class IC) That Can Be Stored per Fire Area<sup>(9)</sup> Outside a Safety Flammable Cabinet</b>				
Location	NFPA Code	Gallons	Liters	Vials <sup>(8)</sup>
General Warehouse <sup>(10)(12)(13)</sup>	30-2015	120	460	23,000
Liquid Warehouse <sup>(3,11)</sup>	30-2015	Unlimited	Unlimited	Unlimited
Office, to include Exam Rooms	30-2015	10	38	1900

<b>Allowable Quantities of PreservCyt Solution That Can Be Stored in a Liquid Storage Room</b>				
Location	NFPA Code	Gallons	Liters	Vials <sup>(8)</sup>
Maximum allowable storage per ft <sup>2</sup> in an inside storage room that is smaller than 150ft <sup>2</sup> in size.	30-2015	5	19	950
Maximum allowable storage per ft <sup>2</sup> in an inside storage room that is larger than 150ft <sup>2</sup> and less than 500ft <sup>2</sup> in size.	30-2015	10	38	1900

- (1) Solution classifications: PreservCyt – Class IC; CytoLyt – Class II; CellFyx – Class IB
- (2) This information is Hologic’s summary of the various regulations. To view the codes in their entirety, please refer to NFPA 30 and NFPA 45.
- (3) A Liquid Warehouse shall have a sprinkler system that complies with the appropriate system indicated in NFPA 30.
- (4) An Inside Liquid Storage Area is a storage room totally enclosed within a building and having no exterior walls.
- (5) A Laboratory Unit is the area surrounded by firewalls per NFPA 30 *Flammable and Combustible Liquids Code*.
- (6) Reduce quantities by 50% for B laboratory units located above the 3<sup>rd</sup> floor.
- (7) Reduce quantities by 25% for C and D laboratory units located on the 4<sup>th</sup>-6<sup>th</sup> floors of a building and reduce quantities by 50% for C and D laboratory units above the 6<sup>th</sup> floor
- (8) 20ml PreservCyt vials.
- (9) A Fire Area is the area of a building separated from the remainder of the building by construction having a fire resistance of at least 1-hour and having all communicating openings properly protected by an assembly having a fire resistance rating of at least 1-hour per NFPA 30 *Flammable and Combustible Liquids Code*.

- (10) Allowable quantities in a warehouse can be increased with a sprinkler system rated higher than standard systems.
- (11) A Liquid Warehouse is a separate, detached building or attached building used for warehousing-type operations for liquids.
- (12) Quantities are permitted to be increased 100% where stored in approved flammable liquids storage cabinets.
- (13) Quantities are permitted to be increased 100% in buildings equipped throughout with an automatic sprinkler system installed in accordance with NFPA13, Standard for the Installation of Sprinkler Systems.

This table lists the NFPA ratings for all the ThinPrep products.

ThinPrep Product	Health Hazard	Flammability Hazard	Instability Hazard	Specific Hazard
ThinPrep PreservCyt Solution	2	3	0	N/A
ThinPrep CytoLyt Solution	2	2	0	N/A
ThinPrep CellFyx Solution	2	3	0	N/A
ThinPrep Rinse Solution	0	0	0	N/A
ThinPrep Bluing Solution	0	0	0	N/A
ThinPrep Rinse II Solution	2	3	0	N/A
ThinPrep Bluing II Solution	0	0	0	N/A
ThinPrep Stain EA Solution	2	3	0	N/A
ThinPrep Stain Orange G Solution	2	3	0	N/A
ThinPrep Nuclear Stain	2	0	0	N/A



## ThinPrep® Solutions Shipping Requirements \*

### Scope:

These requirements include shipping:

- Biological specimens (patient specimens) in ThinPrep® solutions
- Biological specimens in solutions other than ThinPrep® solutions
- Biological specimens not in solutions
- ThinPrep® PreservCyt™ Solution without biological specimens
- ThinPrep® CytoLyt™ Solution without biological specimens

Note: Shippers of Hazardous Materials or Dangerous Goods must be trained according to the various Hazardous Materials/Dangerous Good regulations

### **A. Shipping Requirements when shipping patient samples in ThinPrep PreservCyt Solution only – Ambient Temperature:**

1. Patient samples / biological substances (pathogens) contained ThinPrep PreservCyt Solution are neutralized or inactivated by the solution and as such no longer pose a health risk. (For further information regarding this, refer to the ThinPrep 2000 or ThinPrep 5000 Operators' Manual).
2. Materials that have been neutralized or inactivated are exempt from the Category B Class 6, Division 6.2 requirements.
3. Solutions that contain neutralized or inactivated pathogens, and meet the criteria of one or more of the other hazards risks, must be shipped according to the shipping requirements for that hazard risk(s).
4. ThinPrep PreservCyt Solution is a Flammable liquid when shipped domestic or international. Therefore, follow the instructions in Section C below, Shipping ThinPrep® PreservCyt™ Solution Only (such as from a laboratory to a physician).

### **B Shipping Biological Specimens in Solutions (other than ThinPrep PreservCyt Solution) or Without Solutions**

Notes:

When biological specimens are shipped in a solution of a quantity of 30 ml or less and are packed in accordance with these guidelines, no further requirements in the Hazardous Materials (Dangerous Goods) Regulations need be met. However, training is recommended.”<sup>1</sup>

#### **Definitions:**

- Biological Substance, Category B: Materials containing or suspected to contain infectious substances that do not meet Category A criteria. IATA Dangerous Goods regulations were revised with an effective date of January 1, 2015. Note: The term “diagnostic specimen” has been replaced with “biological substance, Category B”
- Exempt specimens: Specimens that with the minimal likelihood that pathogens are present (fixed tissue, etc.)

\* These instructions are Hologic's interpretation of the various regulations as of the effective date. However, Hologic will not be responsible for any non-conformance to the actual regulations.

## Shipping Requirements Category B or Exempt <sup>1</sup> – Ambient Temperature:

1. Packaging must consist of three components
  - a. a primary receptacle, leak proof
  - b. secondary packaging, leak proof
  - c. a rigid outer packaging

### NOTES:

- FedEx will not accept clinical samples or diagnostic specimens packaged in FedEx envelopes, FedEx tubes, FedEx Paks, or FedEx Boxes, Styrofoam boxes, plastic bags, or paper envelopes.
- FedEx will accept clinical samples in FedEx Clinical Paks, FedEx Medium Clinical Boxes or FedEx Large Clinical Boxes.<sup>2</sup>

2. The primary receptacle cannot contain more than 1L of a liquid substance (500 ml if using FedEx).
3. If multiple fragile primary receptacles are placed in a single secondary packaging, they must be either individually wrapped or separated to prevent contact between them.
4. Absorbent material must be placed between the primary receptacle and the secondary packaging. The absorbent material (cotton balls, cellulose wadding, absorbent packets, paper towels) must be in sufficient quantity to absorb the entire contents of the primary receptacle(s) so that any release of the liquid substance will not compromise the integrity of the cushioning material or the outer packaging.
5. The outer packaging must not contain more than 4L or 4kg of material. This quantity excludes ice, dry ice, or liquid nitrogen when used to keep specimens cold.
6. An itemized list of contents must be enclosed between the secondary packaging and the outer packaging.
7. The packaging must successfully pass a 4 ft. drop test (Section 6.6.1 IATA regulations).
8. The UN3373 mark must be displayed on the external surface of the outer packaging (one surface of the outer packaging must have a minimum dimension of 100 mm x 100 mm FedEx minimum is 7"x 4"x 2") on a background of a contrasting color and must be clearly visible and legible. The mark must be in the form of a diamond with each side having a length of at least 50 mm. Lettering must be at least 6mm high.
9. The proper shipping name "Biological Substance, Category B" in letters at least 6mm high must be marked on the outer package adjacent to the diamond shaped UN3373 mark.

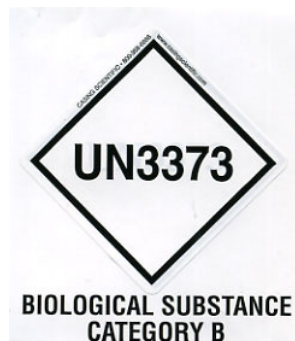

10. If using FedEx, the FedEx USA Airbill, Section 6, Special Handling must be completed with dangerous goods/dry ice information:

*Does this shipment contain dangerous goods?*

YES- Shipper's Declaration not required

11. The outer container of all diagnostic/clinical specimen packages must display the following:

- a. Sender's name and address
- b. Recipient's name and address
- c. The words "Biological Substance, Category B"
- d. The UN 3373 label

**Shipping Requirements Category B or Exempt<sup>1</sup> – Frozen or Refrigerated Specimens:**

NOTE: FedEx defers to IATA regulations for the shipping of refrigerated or frozen diagnostic specimens.<sup>2</sup>

Follow all packaging directions for Category B or Exempt – Ambient Temperature plus:

1. Place ice or dry ice outside of the secondary packaging. Interior supports must be provided to secure the secondary packaging in the original position after the ice or dry ice has dissipated. If ice is used, the outside packaging or overpack must be leak proof. If dry ice is used, the packaging must be designed and constructed to permit the release of CO<sup>2</sup> gas to prevent a buildup of pressure that could rupture the packaging.

2. Always affix the Class 9, UN 1845 dry ice label as well as the UN 3373, Biological Substance, Category B label to these shipments

3. If using FedEx, the FedEx USA Airbill, Section 6, Special Handling must be completed with dangerous goods/dry ice information:

*Does this shipment contain dangerous goods?*

YES- Shipper's Declaration not required

Enter kg of dry ice used (if applicable)

4. The outer container of all diagnostic/clinical specimen packages must display the following:
  - a. Sender's name and address
  - b. Recipient's name and address
  - c. The words "Biological Substance, Category B"
  - d. The UN 3373 label
  - e. Class 9 label, including UN 1845, and net weight if packaged with dry ice

**C Shipping ThinPrep® PreservCyt™ Solution Only (such as from a laboratory to a physician)**

**Domestic Ground Shipments - Limited Quantities:**

Notes:

ThinPrep® PreservCyt™ Solution is classified as a Class 3 Flammable liquid, assigned to Packing Group III (PG III).

49 CFR 173.150 (Limited Quantities) allows ThinPrep® PreservCyt™ Solution in vials to be shipped in Limited Quantities when shipped via ground transportation in a sturdy box. The total volume in a package cannot exceed 5 liters or weigh more than 30 kg (66 lbs). Limited Quantities are exempt from labeling requirements.

Limited Quantity domestic ground shipping recommendations:

1. ThinPrep® PreservCyt™ Solution must be shipped in the vials.
2. Place the vials in a good quality cardboard box, such as the ThinPrep® box that holds 250 vials. Pack vials in a manner (adding protective packing material as necessary) as to limit movement of individual vials.
3. Mark the package as “Flammable liquids, n.o.s., (Methanol Solution), 3, UN1993, Ltd. Qty.” add orientation arrows on the ends, and the Limited Quantity label:

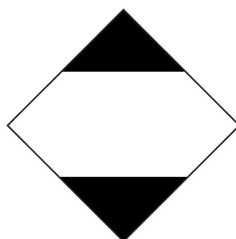

4. Print “UN1993, Flammable liquids, n.o.s., (Methanol Solution), 3, PG III, Ltd. Qty.” on the Shipping papers.

**Domestic Ground Shipments - Other than Limited Quantities:**

When shipping packages in excess of “Limited Quantity” amounts:

1. Do not include “Ltd Qty” in the wording on the package or on the Shipping papers as indicated in c and d above.
2. Affix a Class 3 “Flammable Liquid” hazard label to the outer package in close proximity of the wording described in “C” above. See the example of the label on the last page of these recommendations.
3. Mark the package as “Flammable liquids, n.o.s., (Methanol Solution), 3, UN1993, Net Qty.”

**Domestic Air Shipments:**

In addition to 1 and 2 above in Domestic Ground Shipments – Other than Limited Quantities, the following are recommendations for domestic air shipments:

3. Maximum allowable package sizes are:
  - i. Sixty (60) liters (3000-vials) for passenger aircraft, and
  - ii. Two hundred twenty (220) liters (11,000-vials) for cargo aircraft.

4. Single packages containing more than sixty (60) liters (3000-vials) of total product must be clearly marked "FOR CARGO AIRCRAFT ONLY".
5. The vials must be shipped in United Nations (UN) certified 4G packaging for any quantity in an aircraft. (e.g., ThinPrep® PreservCyt™ Solution 250-vial box or equivalent.)
6. A Class 3 "Flammable Liquid" label must be affixed to the outer package near the words "Flammable liquids, n.o.s., (Methanol Solution)".



#### **All Domestic Shipments:**

The following are recommendations for all domestic ground and air shipments:

1. If the ThinPrep® PreservCyt™ Solution is shipped in a package also containing non-hazardous material, the hazardous material must be listed first, or be printed in a contrasting color (or highlighted) to differentiate it from the non-hazardous material.
2. The total volume of ThinPrep® PreservCyt™ Solution and the number of vials must appear on the shipping papers.

#### **International Ground Shipments - Limited Quantities:**

When shipping internationally, ThinPrep® PreservCyt™ Solution is classified with a primary hazard of Class 3 (Flammable Liquid), and with a secondary hazard of Class 6.1 (Toxic). It is assigned to PG III.

The reference used for the international ground recommendations is the *ADR - European Agreement Concerning the International Carriage of Dangerous Good by Road* (United Nations). A "Limited Quantity" is defined as a package containing a maximum net quantity of 5-liters and not weighing more than 20 kg (40 lbs). The recommendations for international ground shipments are as follows:

1. ThinPrep® PreservCyt™ Solution must be shipped in the vials.
2. Place the vials in a good quality cardboard box, such as the Cytyc box that holds 250 vials. Pack vials in a manner (adding protective packing material as necessary) as to limit movement of individual vials.
3. Mark the package with "UN1992, Flammable liquids, toxic, n.o.s., (Methanol Solution), 3, 6.1, PGIII Ltd. Qty" orientation arrows on the ends and the Limited Quantity label that has a "Y" on it.

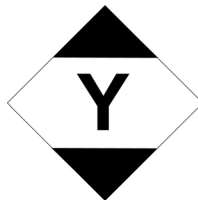

4. The shipping papers should include all the information indicated in "3" above.

#### **International Ground Shipments – Other than Limited Quantities:**

1. Do not include “Ltd Qty” in the wording on the package or on the Shipping papers as indicated in c and d above.
2. Affix both a Class 3 “Flammable Liquid” label and a secondary Class 6.1 “Toxic” label to the package adjacent to the markings. (Copies of the labels can be found on the last page of this document.)



Class 6.1 “Toxic” secondary hazard label.

3. Mark the package with “UN1992, Flammable liquids, toxic, n.o.s., (Methanol Solution), 3, 6.1, PG III, Net Qty”.

#### **International Air Shipments:**

The references used for the International Air recommendations are: In addition to a and b above in International Ground Shipments, the following are the recommendations for international air shipments:

1. Maximum allowable package sizes are:
  - i. Sixty (60) liters (3000-vials) for passenger aircraft, and
  - ii. Two hundred twenty (220) liters (11,000-vials) for cargo aircraft.
2. Packages containing more than sixty (60) liters of product must be clearly marked “FOR CARGO AIRCRAFT ONLY”
3. The vials must be shipped in United Nations (UN) certified 4G packaging for any quantity in an aircraft. (e.g., ThinPrep® PreservCyt™ Solution 250-vial box or equivalent.) Pack vials in a manner (adding protective packing material as necessary) as to limit movement of individual vials.
4. Limited Quantity exemption can only be used if the package has a maximum net quantity of 2-liters.
5. Packaging manufacturer’s specifications markings are not required when shipping Limited Quantity.
6. Mark the package with “UN1992, Flammable liquids, toxic, n.o.s., (Methanol Solution), 3, 6.1, PGIII, Net. Qty”.
7. When a “Cargo Aircraft Only” marking is required, it must be affixed on the same package surface and near the hazard labels.
8. The shipper is responsible for the completion of a “Shipper’s Declaration for Dangerous Goods” form.

#### **D. Shipping ThinPrep® CytoLyt™ Solution Only (such as from a laboratory to a physician)**

##### **Domestic Ground Shipments:**

ThinPrep® CytoLyt™ Solution has a flash point of 109° F. For domestic ground transportation only, a flammable liquid with a flashpoint at or above 100° F that does not meet the definition of any other hazard class may be reclassified as a combustible liquid. As such, ThinPrep® CytoLyt™ Solution, shipped via ground, is exempt from the requirements of the DOT Hazardous Materials Regulations.

**Domestic Air Shipments:**

When shipping ThinPrep® CytoLyt™ Solution via air, follow the Domestic Air Shipments recommendations for Shipping ThinPrep® PreservCyt™ Solution Only that can be found in Section C of this document.

**International Ground and Air shipments:**

When shipping ThinPrep® CytoLyt™ Solution via ground or air, follow the International Ground or Air Shipments recommendations for Shipping ThinPrep® PreservCyt™ Solution Only guidelines that can be found in Section C of this document.

**E. Shipping ThinPrep® CytoLyt™ Solution With Patient Sample (such as from a physician to a laboratory)**

**Domestic Shipments:**

ThinPrep® CytoLyt™ Solution containing a patient sample is classified as a Biological Substance, Category B. Follow the recommendations in Section B of this document.

**International Shipments:**

ThinPrep® CytoLyt™ Solution containing a patient sample is classified as a Biological Substance, Category B. Follow the recommendations in Section B of this document.

**References:**

- 49 CFR 100 to 185, *Transportation*
- *Dangerous Goods Regulations*, 56<sup>th</sup> Edition, 2015, International Air Transportation Association (IATA)
- International Civil Aviation Organization's (ICAO) *Technical Instructions for the Safe Transport of Dangerous Goods by Air*

**Foot Notes:**

1. See Packing Instruction 650 in the IATA *Dangerous Goods Regulations*
2. FedEx Document 33539PL: "Packaging Clinical Samples" and "Packaging UN 3373 Shipments"

**4. Gynecologic  
Sample Preparation**

**4. Gynecologic  
Sample Preparation**



# Chapter Four

## Gynecologic Sample Preparation

**SECTION  
A**

### GYNECOLOGIC SAMPLE PREPARATION

Includes cell samples from the ectocervix and the endocervix.

	<p>1. <b>Collection:</b> Deposit the specimen directly into a PreservCyt<sup>®</sup> Solution vial.</p> <p><b>Note:</b> Proper rinsing technique of the collection device is very important. See specimen collection instructions on pages 4.3 and 4.4.</p>
	<p>2. Allow to stand in PreservCyt Solution for 15 minutes</p>
	<p>3. Run on ThinPrep<sup>®</sup> 5000 processor using <b>Gyn Sequence</b>, stain, and evaluate.</p>



## GYNECOLOGIC SAMPLE PREPARATION

### SECTION B

## COLLECTION PREPARATION

### ThinPrep® Collection Techniques

The detection of cervical cancer and its precursors as well as other gynecologic abnormalities is the primary purpose of obtaining a cervical cell sample. The following guidelines are referenced from CLSI Document GP15-A3<sup>1</sup> and are recommended in the collection process for obtaining a ThinPrep Pap test (TPPT) specimen. In general, the guidelines state that it is important to obtain a specimen that is not obscured by blood, mucus, inflammatory exudate or lubricant.

### Patient Information

- The patient should be tested 2 weeks after the first day of her last menstrual period, and definitely not when she is menstruating.

Even though the TPPT reduces obscuring blood, clinical studies have demonstrated that excessive amounts of blood may still compromise the test and possibly lead to an unsatisfactory result.<sup>2</sup>

- The patient should not use vaginal medication, vaginal contraceptives, or douches during the 48 hours before the exam.

### Specimen Collection Preparation

- Lubricant jellies should not be used to lubricate the speculum.

Even though lubricant jellies are water soluble, excessive amounts of jelly may compromise the test and possibly lead to an unsatisfactory result.

- Remove excess mucus or other discharge present before taking the sample. This should be gently removed with ring forceps holding a folded gauze pad.

The excess cervical mucus is essentially devoid of meaningful cellular material and when present in the sample vial may yield a slide with little or no diagnostic material present.

- Remove inflammatory exudate from the cervical canal before taking the sample. Remove by placing a dry 2 x 2 inch (5 x 5 cm) piece of gauze over the cervix and peeling it away after it absorbs the exudate or by using a dry proctoswab or scopette.

The excess inflammatory exudate is essentially devoid of diagnostic cellular material and when present in the sample vial may yield a slide with little or no diagnostic material present.

- The cervix should not be cleaned by washing with saline or it may result in a relatively acellular specimen.
- The sample should be obtained before the application of acetic acid.

1. Papanicolaou Technique Approved Guidelines (CLSI Document GP15-A3, 2008)

2. Lee et al. Comparison of Conventional Papanicolaou Smears and Fluid-Based, Thin-Layer System for Cervical Cancer Screening. *Ob Gyn* 1997; 90: 278-284.

**SECTION  
C**

**SPECIMEN COLLECTION**

**Collect Gynecologic Sample Using the Broom-Like Device**

Physician/clinician instructions for collecting gynecologic samples.

	<p>1. <b>Obtain</b> an adequate sampling from the cervix using a broom-like device. Insert the central bristles of the broom into the endocervical canal deep enough to allow the shorter bristles to fully contact the ectocervix. Push gently, and rotate the broom in a clockwise direction five times.</p>
	<p>2. <b>Rinse</b> the broom as quickly as possible into the PreservCyt® Solution vial by pushing the broom into the bottom of the vial 10 times, forcing the bristles apart. As a final step, swirl the broom vigorously to further release material. Discard the collection device.</p>
	<p>3. <b>Tighten</b> the cap so that the torque line on the cap passes the torque line on the vial.</p>
	<p>4. <b>Record</b> the patient's name and ID number on the vial. <b>Record</b> the patient information and medical history on the cytology request form.</p>
	<p><b>Note:</b> If the sample is to be processed immediately, allow the sample to stand in the PreservCyt Solution vial for at least 15 minutes before processing.</p> <p>If the sample is to be sent elsewhere for processing, continue with the next step.</p>
	<p>5. <b>Place</b> the vial and requisition in a specimen bag for transport to the laboratory.</p>







Refer to the instructions provided with the collection device for warnings, contraindications, and limitations associated with specimen collection.

# 4

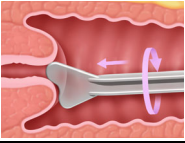
## GYNECOLOGIC SAMPLE PREPARATION

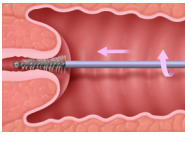
### Collect Gynecologic Sample, Using the Endocervical Brush/Spatula Device

Physician/clinician instructions for collecting gynecologic samples.

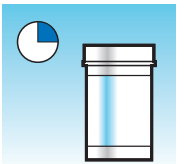
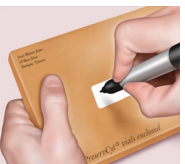
	<p>1. <b>Obtain</b> an adequate sampling from the ectocervix using a <i>plastic spatula</i>.</p>
	<p>2. <b>Rinse</b> the spatula as quickly as possible into the PreservCyt® Solution vial by swirling the spatula vigorously in the vial 10 times. Discard the spatula.</p>
	<p>3. <b>Obtain</b> an adequate sampling from the endocervix using an endocervical brush device. Insert brush into the cervix until only the bottom-most fibers are exposed. Slowly rotate 1/4 or 1/2 turn in one direction. <b>DO NOT OVER-ROTATE.</b></p>
	<p>4. <b>Rinse</b> the brush as quickly as possible in the PreservCyt Solution by rotating the device in the solution 10 times while pushing against the PreservCyt vial wall. Swirl vigorously to further release material. Discard the brush.</p>
	<p>5. <b>Tighten</b> the cap so that the torque line on the cap passes the torque line on the vial.</p>
	<p>6. <b>Record</b> the patient's name and ID number on the vial. <b>Record</b> the patient information and medical history on the cytology requisition form.</p>
	<p><b>Note:</b> If the sample is to be processed immediately, allow the sample to stand in the PreservCyt Solution vial for at least 15 minutes before processing.</p> <p>If the sample is to be sent elsewhere for processing, continue with the next step.</p>
	<p>7. <b>Place</b> the vial and requisition in a specimen bag for transport to the laboratory.</p>

Refer to the instructions provided with the collection device for warnings, contraindications, and limitations associated with specimen collection.

SECTION  
D

## SPECIAL PRECAUTIONS

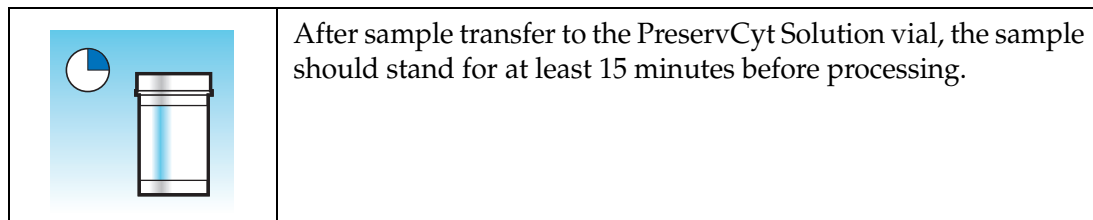
**PreservCyt® Solution**

For more information on PreservCyt Solution, refer to Chapter 3, PreservCyt® & CytoLyt® Solutions.

**Interfering Substances**

The Clinical and Laboratory Standard Institute Guidelines (formerly NCCLS) recommend that no lubricant be used during Pap testing.<sup>1</sup>

ACOG recommends that care be taken not to contaminate the specimen with lubricant because this may lead to unsatisfactory results.<sup>2</sup> This applies to both conventional Pap testing and liquid-based cytology.

If you are using a plastic speculum, or in instances where a lubricant must be used, take care not to contaminate the cervix or collection devices with the lubricant. A tiny amount of lubricant may be used, just enough to sparingly coat the speculum with a gloved finger, avoiding the tip of the speculum.

The Clinical and Laboratory Standard Institute Guidelines and ACOG recommend that you not take a Pap during menses.<sup>1-2</sup>

For samples to be processed on the ThinPrep 5000 processor, lubricants can adhere to the filter membrane and may cause poor cell transfer to the slide. If its use is unavoidable, the lubricant should be used in minimum amounts.

**Handling/Disposal**

Handle all chemical-containing materials carefully in accordance with safe laboratory practices. When required by reagent composition, additional precautions are marked on the reagent containers.

Dispose of PreservCyt Solution according to your guidelines for disposing of hazardous waste. PreservCyt Solution contains methanol.

1. Papanicolaou Technique Approved Guidelines (CLSI Document GP15-A3, third edition, 2008)

2. ACOG Practice Bulletin, no. 45, August 2003

# 4

## GYNECOLOGIC SAMPLE PREPARATION

### SECTION E

## SAMPLE PROCESSING TROUBLESHOOTING

### Reprocessing a ThinPrep® Pap Test Sample Vial Following an Unsatisfactory Result

Laboratory personnel may reprocess ThinPrep® Pap test specimens where slides have been interpreted as inadequate (“Unsatisfactory for Evaluation”) for diagnosis following cytotechnologist screening. The instructions below must be followed in order to properly reprocess these specimens:

**Note:** Reprocessing a ThinPrep Pap test specimen may only be performed once.

**Note:** Good laboratory practices should be followed to avoid introducing contaminants into the PreservCyt Solution sample vial.

### Reprocessing Protocol

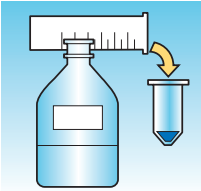
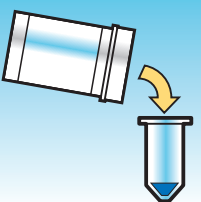
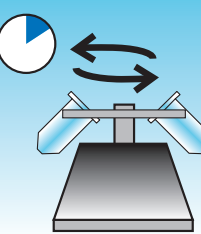
	<p>1 Prepare a wash solution of sufficient volume to add 30 mL to every ThinPrep Pap test specimen being reprocessed. The wash solution is made by mixing 9 parts CytoLyt® Solution with 1 part glacial acetic acid.</p>
	<p>2 Prior to performing this step, assure there is sufficient volume in the ThinPrep Pap test specimen to result in a pellet, following centrifugation. Pour the contents of the ThinPrep Pap test specimen into a centrifuge tube appropriately labeled to maintain chain of custody. Retain the vial.</p>
	<p>3 Pellet the contents of the centrifuge tube by centrifugation at 1200 x g for 5 minutes.</p> <p><b>Note:</b> Once centrifugation is complete, the cell pellet should be clearly visible but the cells may not be tightly packed together (the pellet may appear fluffy).</p>

	<p>4</p> <ol style="list-style-type: none"> <li>Carefully pour off the supernatant from the centrifuge tube to avoid loss of cells. Dispose of according to local regulations.</li> <li>Vortex the centrifuge tube briefly.</li> <li>Pour 30 mL of the CytoLyt<sup>®</sup> Solution and 10% glacial acetic acid mixture into the centrifuge tube and cap securely.</li> <li>Invert the centrifuge tube by hand several times to mix.</li> </ol>
	<p>5</p> <p>Pellet the cells again by centrifugation—1200 x g for 5 minutes.</p>
	<p>6</p> <ol style="list-style-type: none"> <li>Carefully pour off the supernatant from the centrifuge tube to avoid loss of cells. Dispose of according to local regulations.</li> <li>Vortex the centrifuge tube briefly.</li> </ol>
	<p>7</p> <ol style="list-style-type: none"> <li>Using the volume markings on the centrifuge tube, pour the necessary quantity of unused (i.e., containing no patient specimens) PreservCyt<sup>®</sup> Solution to the cells and fill to a final volume of 20 mL. Secure the cap tightly.</li> <li>Invert the centrifuge tube several times to mix and transfer the sample back into the retained specimen vial.</li> </ol>
	<p>8</p> <p>Process the specimen using a ThinPrep<sup>®</sup> 5000 processor according to the procedure for running gynecologic specimens. Evaluate the resultant slide according to <i>The Bethesda System for Reporting Cervical/Vaginal Cytologic Diagnosis</i>. If after reprocessing, negative results from specimen do not fit with the clinical impression, a new specimen may be necessary.</p>



## GYNECOLOGIC SAMPLE PREPARATION

This page intentionally left blank.



**5. Non-Gynecologic  
Sample Preparation**

**5. Non-Gynecologic  
Sample Preparation**

# Chapter Five

---

## Non-Gynecologic Sample Preparation

**SECTION****A****INTRODUCTION**

This chapter provides instructions for preparing non-gynecologic (non-gyn) samples and making slides with the ThinPrep® 5000 processor.

For the best results, carefully follow the instructions in this chapter. Because there is biological variability among samples and variability in collection methods, standard processing may not always yield a satisfactory and uniformly distributed preparation on the first slide. This chapter contains troubleshooting instructions for further sample processing to obtain better quality subsequent slides in these cases. This chapter also provides an outline of various sample collection methods and the appropriate procedures for each.

Content found in this chapter:

**REQUIRED MATERIALS****SPECIMEN COLLECTION****METHODS OF SAMPLE PREPARATION**

- Concentrate by centrifugation — 600g for 10 Min.
- Pour off supernatant and vortex to resuspend cell pellet
- Evaluate cell pellet appearance
- Add specimen to PreservCyt® Solution vial
- Allow to stand in PreservCyt Solution for 15 min.
- Run on ThinPrep® 5000 processor using Sequence Non-Gyn. Fix, stain, and evaluate.
- Mechanical agitation
- CytoLyt® Solution wash

**SPECIMEN PREPARATION GUIDELINES**

- Fine Needle Aspirates
- Muroid Specimens
- Body Fluids
- ThinPrep® UroCyt® Specimens

**SAMPLE PREPARATION TROUBLESHOOTING**

# 5

## NON-GYNECOLOGIC SAMPLE PREPARATION

### SECTION B

## REQUIRED MATERIALS

### From Hologic:

- CytoLyt® Solution  
CytoLyt tubes  
CytoLyt cups  
CytoLyt bottles (bulk)
- PreservCyt® Solution

PreservCyt vials

PreservCyt bottles (bulk)

- Non-Gyn ThinPrep® filters (blue)
- ThinPrep UroCyte® filter (yellow) for the Vysis® UroVysion assay urine specimens
- ThinPrep UroCyte microscope slides for the Vysis UroVysion assay urine specimens
- ThinPrep UroCyte PreservCyt vials for the Vysis UroVysion assay urine specimens
- ThinPrep microscope slides
- ThinPrep 5000 processor
- Vortexor

**Note:** Refer to the Ordering Information in this manual for more information about supplies and solutions from Hologic.

### From Other Suppliers:

- 50-mL capacity centrifuge (free swing basket)
- Centrifuge tubes, 50 mL
- Plastic transfer pipettes, 1 mL, graduated
- Balanced electrolyte solutions
- Slide staining system and reagents
- Standard laboratory fixative
- Coverslips and mounting media
- Blender (optional)
- Glacial acetic acid (*troubleshooting only*)
- DiThioThreitol (DTT, optional, mucoid samples only)

**WARNING:** Do not process a cerebrospinal fluid (CSF) specimen or other sample type that is suspected of possessing prion infectivity (PrPsc) derived from a person with a TSE, such as

Creutzfeldt-Jakob disease, on a ThinPrep processor. A TSE-contaminated processor cannot be effectively decontaminated and therefore must be properly disposed of in order to avoid potential harm to users of the processor or service personnel.

**SECTION  
C****SPECIMEN COLLECTION**

**Note:** The ThinPrep® 5000 processor is designed for use with PreservCyt® Solution only. Do not use any other collection or preservative solution with the processor.

Samples to be processed on the ThinPrep processor will arrive in the lab either fresh or in CytoLyt® Solution. There are preferred collection methods for different sample types. This section will describe the Hologic-recommended procedure as well as alternate collection methods.

**WARNING:** For washes and lavages, do not expose the patient to CytoLyt Solution.

**Fine Needle Aspirate Specimens**

The optimal collection technique for FNAs is to deposit and rinse the entire sample into a centrifuge tube containing 30 mL of CytoLyt Solution. A secondary method would be to collect the sample into a balanced electrolyte solution, such as Polysol® or Plasma-Lyte® injection solutions.

**Note:** Direct smears may be necessary for radiologic-guided FNAs when a rapid analysis of specimen adequacy is required.

**Mucoid Specimens**

Mucoid specimens are best collected into CytoLyt Solution. If they are collected fresh, CytoLyt Solution should be added as soon as possible. Early addition of CytoLyt Solution preserves the sample and initiates the mucus dissolution process.

Large volume of fresh mucoid specimens (greater than 20 mL) should be concentrated before addition of CytoLyt Solution to the sample.

**Fluid Specimens**

The preferred method for preparing fluid samples (urinary tract, effusions, synovial, and cyst fluids) is to concentrate the fresh sample before any addition of CytoLyt Solution. If this is not possible and the samples must be preserved for transport to the lab, collect the samples in CytoLyt Solution.

**Note:** CytoLyt Solution added directly to fluids with high levels of protein may produce some degree of protein precipitation.

**Note:** Fluid collection in CytoLyt® Solution is only considered a collection step and not a wash step. See "CYTOLYT SOLUTION WASH" on page 5.12 for more detail.



## NON-GYNECOLOGIC SAMPLE PREPARATION

The quantity of fluid samples can vary widely from less than 1 mL to 1000 mL and more. Each lab must follow its own procedure for determining the amount of sample to use for processing. If more than one centrifuge tube of sample is used, the cell pellets can be combined after pouring off the supernatant.

### Other Sample Types

For non-mucoid brushings and scrapings that are received in PreservCyt® Solution, the sample is ready to be run on the ThinPrep® 5000 processor.

For non-mucoid brushing and scrapings that are received in CytoLyt Solution, follow the protocol for FNA samples. See “FINE NEEDLE ASPIRATES (FNA)” on page 5.14.

### Urine Sample for Use with the Vysis® UroVysion Assay

Follow the instructions that come with the UroCyte Urine Collection Kit. If using the UroCyte Urine Collection Kit, do not exceed a 2:1 ratio of urine to PreservCyt Solution. If the urine volume exceeds 60 mL, pour off excess. A minimum volume of 33 mL of urine is required to perform the Vysis® UroVysion assay.

### Other Collection Media

In cases where CytoLyt Solution is contraindicated, balanced electrolyte solutions, such as Plasma-Lyte and Polysol, may be used as collection media for samples to be processed on the ThinPrep 5000 processor. These solutions are primarily used as media for washings or lavages which contact the patient.

### Non-Recommended Collection Media

Hologic does not recommend the use of the following collection solutions with the ThinPrep 5000 processor. Use of these solutions will produce sub-optimal results:

- Sacomanno and other solutions containing carbowax
- Alcohol
- Mucollexx®
- Normal Saline
- Culture media, RPMI Solution
- PBS
- Solutions containing formalin

Specimens *must* be centrifuged and washed in CytoLyt® Solution and transferred to PreservCyt® Solution prior to being processed on the ThinPrep® 5000 processor.

Refer to page 5.12 for CytoLyt Solution wash instructions.

**Note:** See Chapter 3, PreservCyt® & CytoLyt® Solutions for more information on CytoLyt Solution.

**WARNING:** CytoLyt Solution is a poison (contains methanol) and it must never come in direct contact with the patient.

SECTION  
D

## GENERAL STEPS FOR SAMPLE PREPARATION

### CONCENTRATE BY CENTRIFUGATION – 600g for 10 Minutes

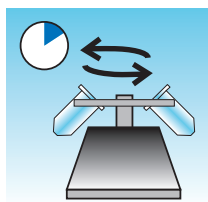

The purpose of this procedure is to concentrate the cellular material in order to separate the cellular component(s) from the supernatant. This step is performed with fresh samples and after the addition of CytoLyt® Solution. When specified in the protocol, centrifuge samples at 600 times normal gravity (600g) for 10 minutes to force the cells in solution into a pellet at the bottom of the centrifuge tube.

Set your centrifuge to the approximate number of revolutions per minute (rpm) to spin the cells at 600g.

Follow these steps to determine the correct setting for your centrifuge:

**CAUTION:** Check cell morphology on non-critical experimental samples before making any changes to your centrifugation process.

**Note:** Use of fixed-angle centrifuges is not recommended.

#### Measure the rotor length of your centrifuge

Use a centimeter ruler to measure the radius of your centrifuge, the distance from the center of the rotor to the bottom of the bucket extended horizontally as shown in Figure 5-1.

# 5

## NON-GYNECOLOGIC SAMPLE PREPARATION

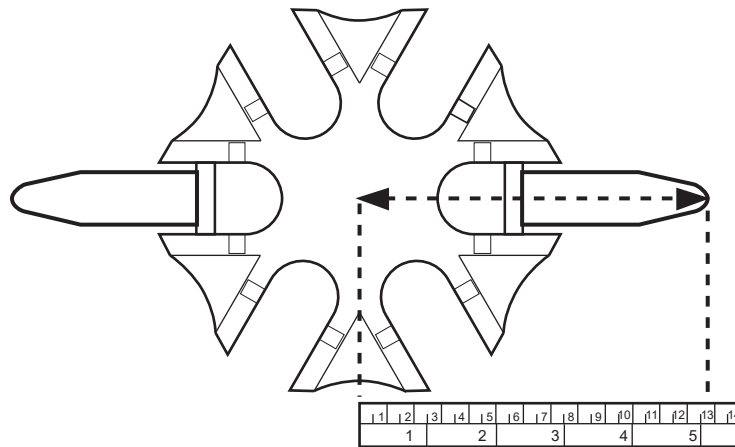

**Figure 5-1 Measuring the Centrifuge**

Find the radius of your centrifuge in the first column of Figure 5-2. Draw a line from the radius value through the 600 Gravities (g) column and into the rpm column. Read the rpm value from the straight edge as shown in Figure 5-2. Run your centrifuge at this speed to achieve a force of 600g on your samples.

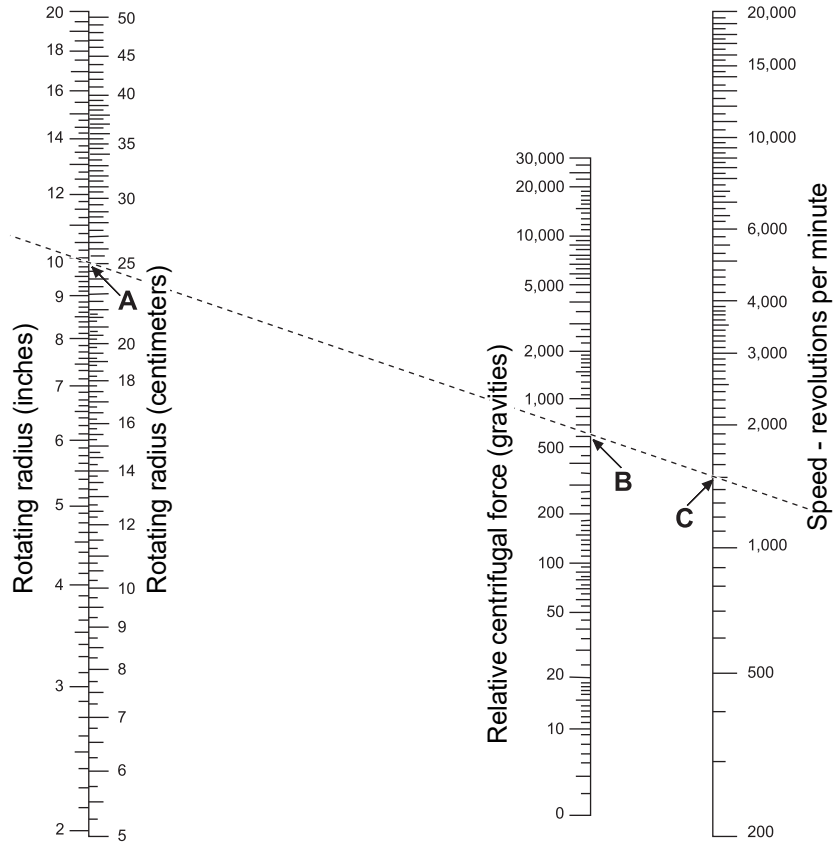

**Figure 5-2 Determining the Correct Centrifuge Speed**

To reduce the time required for the centrifugation step, operate your centrifuge at 1200g for 5 minutes.

**POUR OFF SUPERNATANT AND VORTEX TO RESUSPEND CELL PELLET**

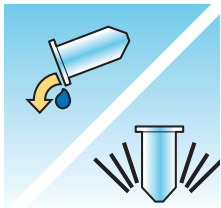

Pour off the supernatant completely to effectively concentrate the sample. To do this, invert the centrifuge tube 180 degrees in one smooth movement, pour off all the supernatant, and then return the tube to its original position as shown in Figure 5-3.<sup>1</sup> Observe the cell pellet during inversion to avoid accidental loss of cellular material.

**CAUTION:** Failure to completely pour off the supernatant may produce a sparse sample and an unsatisfactory slide due to dilution of the cell pellet.

1. Refer to Bales, CE, and Durfee, GR. Cytologic Techniques in Koss, L. ed. Diagnostic Cytology and its Histopathologic Basis. 3rd Edition. Philadelphia: JB Lippincott. Vol. II: pp. 1187–12600 for details.



# 5

## NON-GYNECOLOGIC SAMPLE PREPARATION

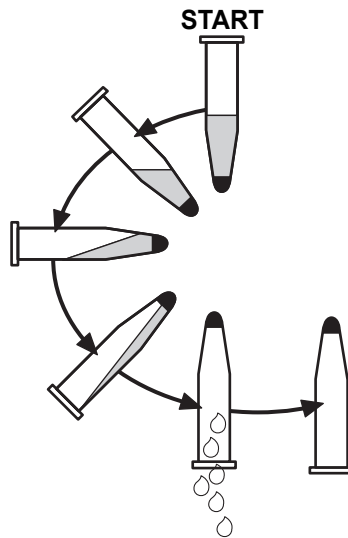

**Figure 5-3 Pouring Off Supernatant**

After pouring off the supernatant, place the centrifuge tube onto a vortexer and agitate the cell pellet for 3 seconds. Manual vortexing may be achieved by syringing the pellet back and forth with a plastic pipette. The intention of this vortexing step is to randomize the cell pellet before transferring to the PreservCyt<sup>®</sup> Solution vial and to improve the results of the CytoLyt<sup>®</sup> Solution washing procedure.

**EVALUATE CELL PELLETT APPEARANCE**

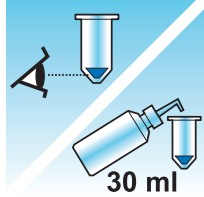

Appearance of Cell Pellet	Procedure
Cell pellet is white, pale pink, tan, or not visible.	Add specimen to PreservCyt® Solution vial. See page 5.10 in this chapter.
Cell pellet is distinctly red or brown indicating the presence of blood.	CytoLyt® Solution wash See page 5.12 in this chapter. <ul style="list-style-type: none"> <li>• Add 30 mL CytoLyt Solution.</li> <li>• Concentrate by centrifugation.</li> <li>• Pour off supernatant and vortex to resuspend cell pellet.</li> </ul>
Cell pellet is mucoid (not in liquid form).  To test for liquid form, draw a small amount of the sample into a pipette and deliver drops back into the tube.  If the drops appear stringy or gelatinous, then the mucus must be further liquefied.	CytoLyt Solution wash See page 5.12 in this chapter. <ul style="list-style-type: none"> <li>• Add 30 mL CytoLyt Solution</li> <li>• Mechanical agitation</li> <li>• Concentrate by centrifugation</li> <li>• Pour off supernatant and vortex to resuspend cell pellet.</li> </ul>

# 5

## NON-GYNECOLOGIC SAMPLE PREPARATION

### ADD SPECIMEN TO PRESERVCYT SOLUTION VIAL

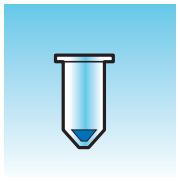
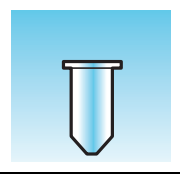
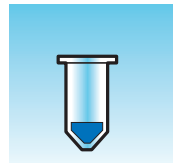

Determine the cell pellet size and refer to the table below:

Size of Cell Pellet		Procedure
	Pellet is clearly visible and the pellet volume is less than 1 mL.	Place the centrifuge tube in a vortexor to resuspend the cells in the residual liquid or mix the pellet by syringing it manually with a pipette. Transfer 2 drops of the pellet to a fresh PreservCyt® Solution vial.
	Pellet is not visible or is scant.	Add the contents of a fresh PreservCyt Solution vial (20 mL) into the tube. Vortex briefly to mix the solution and pour the entire sample back into the PreservCyt Solution vial.
	Pellet volume is greater than 1 mL.	Add 1 mL of CytoLyt® Solution into the tube. Vortex briefly to resuspend the pellet. Transfer <b>1 drop</b> of the specimen to a fresh PreservCyt Solution vial.

### Factors to Consider

The type of pipette that you use may affect the concentration of the sample that is added to the PreservCyt Solution vial, and therefore may affect the volume of sample. Hologic recommends using standard, 1 mL, graduated, plastic pipettes.

If a “Sample Is Dilute” message occurs repeatedly and specimen remains in the specimen tube, increase the number of drops of concentrated sample added to the vial.

Your technique for pouring off the supernatant may also affect the concentration of the sample. If the supernatant is not completely poured off, then additional drops of the sample may be required. The total volume added to the vial must not exceed 1 mL.

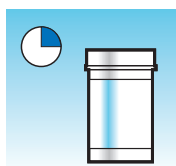
**ALLOW TO STAND IN PRESERVCYT SOLUTION FOR 15 MINUTES**

After sample transfer to the PreservCyt® Solution vial, the sample should stand for at least 15 minutes before processing to allow the PreservCyt Solution to render the sample non-infectious.

For more information on PreservCyt Solution, refer to Chapter 3, PreservCyt® & CytoLyt® Solutions.

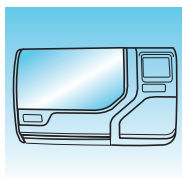
**RUN ON THINPREP 5000 PROCESSOR USING SEQUENCE NON-GYN. FIX, STAIN, AND EVALUATE.**

After the sample has been in contact with PreservCyt Solution for 15 minutes, it may be processed on the ThinPrep® 5000 processor. The operator loads the instrument and selects the appropriate sequence for the sample to be processed as described in Chapter 7, Operating Instructions

At the completion of the process, the operator stains and coverslips the slide according to the procedure in Chapter 10, Staining and Coverslipping.

When the slide is stained and coverslipped, it is microscopically reviewed by a cytotechnologist or pathologist. If the slide appears unsatisfactory after microscopic review, another slide may be made from the specimen using the SAMPLE PREPARATION TROUBLESHOOTING procedures on page 5.22 of this chapter.

**MECHANICAL AGITATION**

Mucoid specimens require vigorous agitation in CytoLyt® Solution to break up the mucus. Hologic recommends two methods of mechanical agitation:

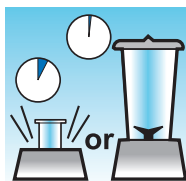
**Method A:**

Vortex the CytoLyt Solution/sample mixture for at least 5 minutes on a “hands-free” vortexor. The vortexor speed must be adjusted to produce visible agitation to the bottom of the tube.

**Method B:**

Blend the CytoLyt Solution/sample mixture for a few seconds.

**Note:** Agitation times for both methods may vary due to differences in specimen consistency.

The blending technique may show fragmentation or disruption of cell architecture. Excessive blending must be avoided.

Vortexing for at least 5 minutes after blending helps break up more mucus.

# 5

## NON-GYNECOLOGIC SAMPLE PREPARATION

### CYTOLYT SOLUTION WASH

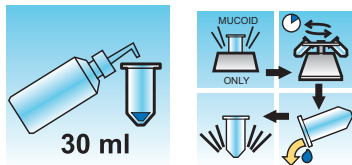

Addition of CytoLyt® Solution to cell pellets is required to wash the sample. A **CytoLyt Solution Wash** performs the following functions while preserving cellular morphology:

- Lyse red blood cells
- Dissolve mucus
- Reduce protein precipitation

A **CytoLyt Solution Wash** consists of the following process:

- Adding 30 mL of CytoLyt Solution to a cell pellet
- *Mucoid Specimens Only: Mechanical agitation*
- Concentration by centrifugation — 600g x 10 minutes
- Pouring off the supernatant and vortexing to resuspend the cell pellet

One **CytoLyt Solution Wash** is usually adequate to clean most non-gyn samples. For particularly bloody or mucoid specimens, additional **CytoLyt Solution Washes** may be necessary.

When a sample is collected in CytoLyt Solution at a ratio less than 30 parts CytoLyt Solution to 1 part sample, this is considered a *Collection Step* and not a *Wash Step*. For example, if one collects 15 mL of a sample and adds 30 mL of CytoLyt Solution to this sample, then the CytoLyt Solution: sample ratio is only 2 to 1 and this is considered a sample collection step and still requires a **CytoLyt Solution Wash**.

For more information on CytoLyt Solution, refer to Chapter 3, PreservCyt® & CytoLyt® Solutions.



**SECTION  
E****SPECIMEN PREPARATION GUIDELINES**

The following guidelines outline the preferred methods for preparing the different types of specimens. The methods are described in general terms. For more detailed information about each step, refer to the description of the methods in Section D of this chapter. See Section F for troubleshooting sample preparation.

# 5

## NON-GYNECOLOGIC SAMPLE PREPARATION

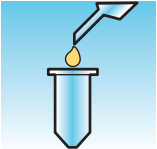
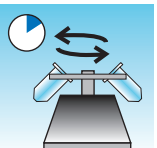
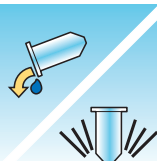
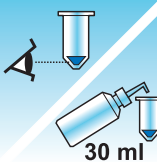
### FINE NEEDLE ASPIRATES (FNA)

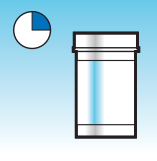
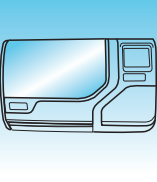
	<p>1. <b>Collection:</b> Collect sample directly into 30 mL of CytoLyt® Solution. If specimen must be collected in an intravenous solution, use a balanced electrolyte solution.</p> <p><b>Note:</b> If possible, flush the needle and syringe with a sterile anticoagulant solution prior to aspirating the sample. Some anticoagulants may interfere with other cell processing techniques, so use caution if you plan to use the specimen for other testing.</p>
	<p>2. Concentrate by centrifugation — 600 g for 10 minutes (page 5.5) or 1200 g for 5 minutes.</p>
	<p>3. Pour off supernatant and vortex to resuspend cell pellet (page 5.7).</p>
 <p>30 ml</p>	<p>4. Evaluate cell pellet appearance (page 5.9). If cell pellet is not free of blood, add 30 mL of CytoLyt Solution to cell pellet and repeat from step 2.</p>
	<p>5. Add appropriate amount of specimen (dependent on the size of the cell pellet) to PreservCyt® Solution vial (page 5.10).</p>
	<p>6. Allow to stand in PreservCyt Solution for 15 minutes (page 5.11).</p>
	<p>7. Run on ThinPrep® 5000 processor using <b>Sequence Non-Gyn</b>, fix, stain, and evaluate.</p>

## MUCOID SPECIMENS

Mucoid specimens may include respiratory and gastrointestinal specimens.

	<p>1. <b>Collection:</b> Collect sample directly into 30 mL of CytoLyt® Solution. OR Add 30 mL of CytoLyt Solution to the fresh specimen as soon as possible.</p> <p><b>Note:</b> Large specimens (greater than 20 mL) should be concentrated before addition of CytoLyt Solution to the sample.</p>
<p>Optional:</p>	<p>If DTT is being used with respiratory mucoid samples, add stock before agitation. See the following page for preparation instructions.</p>
	<p>2. Mechanical agitation (page 5.11) <b>Note:</b> Vortex for a minimum of 5 minutes in “hands-free” vortexor.</p>
	<p>3. Concentrate by centrifugation — 600 g for 10 minutes (page 5.5) or 1200 g for 5 minutes.</p>
	<p>4. Pour off supernatant and vortex to resuspend cell pellet (page 5.7).</p>
	<p>5. Evaluate cell pellet appearance (page 5.9). Confirm the cell pellet is in liquid form. If the cell pellet is not in liquid form, add 30 mL of CytoLyt Solution and repeat steps 2-4.</p>
	<p>6. Add an appropriate amount of specimen (dependent on the size of the cell pellet) to PreservCyt® Solution vial (page 5.10).</p>



# 5

## NON-GYNECOLOGIC SAMPLE PREPARATION

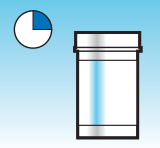
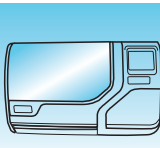
	<p>7. Allow to stand in PreservCyt Solution for 15 minutes (page 5.11).</p>
	<p>8. Run on ThinPrep® 5000 processor using <b>Sequence Non-Gyn</b>. Fix, stain, and evaluate.</p>

### Procedure for the Use of DiThioThreitol (DTT) with Mucoïd Non-Gyn Samples

DTT has been shown to be a reagent that is effective in reducing the amount of mucus in respiratory samples.<sup>1,2</sup>

#### DTT stock solution

- Prepare a stock solution by adding 2.5 g DTT<sup>3</sup> to 30 mL of CytoLyt® Solution.
- This solution is suitable for use for 1 week when stored at room temperature (15°C–30°C).

#### Sample preparation

- This procedure is designed for mucoïd non-gyn sample processing. Follow the steps for processing mucoïd specimens on the previous page.
- After sample collection (Step 1), but prior to vortexing (Step 2), add 1 mL of the stock DTT solution to the sample.
- Proceed with the remaining sample processing steps as listed.

1. Tockman, MS et al., 'Safe Separation of Sputum Cells from Mucoïd Glycoprotein' Acta Cytologica 39, 1128 (1995).
2. Tang, C-S, Tang CMC and Kung, TM, 'Dithiothreitol Homogenization of Prefixed Sputum for Lung Cancer Detection', Diagn. Cytopathol. 10, 76 (1994).
3. Available from Amresco, contact a sales representative at 800-448-4442 or [www.amresco-inc.com](http://www.amresco-inc.com).

## BODY FLUIDS

Body Fluids may include serous effusions, urinary and cerebrospinal fluids.

	<p>1. <b>Collection:</b> Collect body fluids fresh.</p> <p><b>Note:</b> Fluids collected in CytoLyt® Solution also require a CytoLyt Solution wash prior to instrument processing.</p> <p><b>Note:</b> For extremely bloody fluids (i.e., pericardial), start with only 10 mL of fresh fluid.</p> <p><b>Note:</b> Urine may be collected into PreservCyt Solution utilizing the ThinPrep® UroCyt® Urine Collection Kit. (Refer to page 5.19 for details.)</p>
	<p>2. Concentrate by centrifugation — 600 g for 10 minutes (page 5.5) or 1200 g for 5 minutes.</p>
	<p>3. Pour off supernatant and vortex to resuspend cell pellet (page 5.7).</p>
	<p>4. CytoLyt Solution wash (page 5.12)</p>
	<p>5. Evaluate cell pellet appearance (page 5.9). If cell pellet is not free of blood, add 30 mL of CytoLyt Solution to cell pellet and repeat from step 2.</p>
	<p>6. Add an appropriate amount of specimen (dependent on the size of the cell pellet) to PreservCyt® Solution vial (page 5.10).</p>

# 5

## NON-GYNECOLOGIC SAMPLE PREPARATION

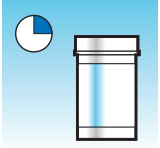
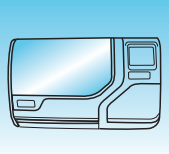
	7. Allow to stand in PreservCyt Solution for 15 minutes (page 5.11).
	8. Run on ThinPrep® 5000 processor using <b>Sequence Non-Gyn</b> , fix, stain, and evaluate.

## THINPREP® UROCYTE® SPECIMENS

For use with Vysis UroVysion. If performing urine cytology, follow the BODY FLUIDS protocol.

	<p>1. <b>Collection:</b> Collect urine directly into the ThinPrep UroCyte Urine Collection Kit, <b>OR</b> process urine fresh.</p> <p><b>Note:</b> Fresh urine can be mixed with a 2:1 urine-to-PreservCyt® Solution ratio and stored for up to 48 hours before processing.</p> <p><b>Note:</b> If using the UroCyte Urine Collection Kit, do not exceed a 2:1 ratio of urine to PreservCyt® Solution. If the urine volume exceeds 60 mL, pour off excess. A minimum volume of 33 mL of urine is required to perform the Vysis® UroVysion assay.</p>
	<p>2. Concentrate by centrifugation (page 5.5). Transfer the sample evenly into two labeled 50-mL centrifuge tubes. Centrifuge at 600g for 10 minutes or 1200 g for 5 minutes.</p>
	<p>3. Pour off supernatant and resuspend cell pellet (page 5.7). Resuspension can be done on a vortexor or may be achieved by syringing the pellet back and forth with a plastic pipette.</p>
	<p>4. CytoLyt® Solution wash (page 5.12) Add 30 mL of CytoLyt Solution to one 50-mL centrifuge tube and vortex. Transfer the contents of this tube into the second 50-mL centrifuge tube and vortex. The specimen is now combined into one 50-mL tube. The empty tube can be discarded. Centrifuge. Pour off supernatant. Resuspend cell pellet.</p>
	<p>5. Evaluate cell pellet appearance (page 5.9). If the cell pellet is not free of blood, add 30 mL of CytoLyt Solution and repeat from step 4.</p>



# 5

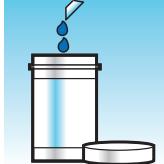
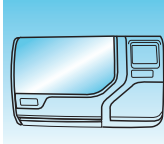

## NON-GYNECOLOGIC SAMPLE PREPARATION

	<p>6. Add entire specimen to PreservCyt® Solution vial (page 5.10). Allow to stand in PreservCyt Solution for 15 minutes.</p>
	<p>7. Run on ThinPrep® 5000 processor using <b>Sequence UroCyt</b>. Fix, stain, and evaluate cytology, <b>OR</b> perform the molecular diagnostic testing according to the manufacturer's instructions for use.</p> <p><b>Note:</b> UroCyt samples require the yellow ThinPrep UroCyt filter and UroCyt microscope slide for processing.</p>

### Instructions for Using the ThinPrep UroCyt Urine Collection Kit

**Note:** The specimen collection cup has a blue cap. The PreservCyt Solution vial has a white cap.

	<p>1. On the specimen collection cup, record patient information in the space provided.</p>
	<p>2. Collect urine in a routine manner. If urine volume exceeds 60 mL, pour off excess. The total volume of urine must not exceed 60 mL. A minimum of 33 mL of urine is required to perform the Vysis® UroVysion assay.</p>
	<p>3. After the urine is collected, carefully pour PreservCyt Solution into specimen cup containing urine. Do not spill PreservCyt Solution.</p>

	<p>4. Tightly secure blue cap on specimen cup to prevent leakage. (Keep turning for another 1/4 inch after you hear the audible click.)</p>
	<p>5. Place cup and absorbent pads into biohazard bag. Tightly seal bag.</p> <p>6. Store between 4°C and 30°C (39°F–86°F). Preferred storage and shipping conditions are on ice packs (e.g., blue ice in styrofoam). Specimen must be processed within 48 hours. Transport the specimen according to your internal procedures.</p>



## NON-GYNECOLOGIC SAMPLE PREPARATION

### SECTION F

## SAMPLE PREPARATION TROUBLESHOOTING

Because there is biological variability among samples and variability in collection methods, standard processing may not always yield a satisfactory and uniformly distributed preparation on the first slide. This section contains instructions for further sample processing to obtain better quality subsequent slides in these cases.

After staining, you may observe the following irregularities:

- Non-uniform distribution of the cells in the cell spot that was not accompanied by a “Sample Is Dilute” message.
- Uneven distribution in the form of a ring or “halo” of cellular material and/or white blood cells
- A sparse cell spot lacking in a cellular component and containing blood, protein, and debris. This type of slide may be accompanied by a “Sample Is Dilute” message.

**Note:** Satisfactory slide appearance is a matter of judgment and experience. Hologic recommends that you check the quality of the slide after staining. If you determine that the slide is unsatisfactory, use the procedures in this section to make additional slides.

**Note:** Sample preparation troubleshooting as described here has not been evaluated for ThinPrep® UroCyte® samples.



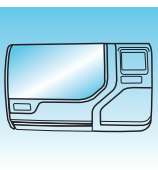
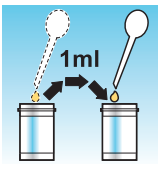
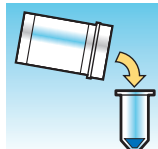
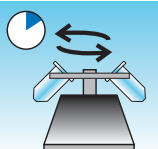
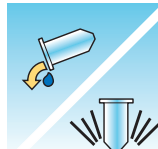
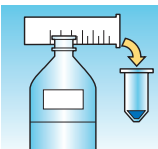

**Bloody or Proteinaceous Specimens**

Problem	Procedure	
<p>A. Did the “Sample Is Dilute” message appear during processing?</p> <p><b>NO</b> ↓     <b>YES</b> ⇒</p>	<p>1. Check to see if cellularity is adequate. If not, use more of the pellet if available. Prepare a slide using sequence Non-Gyn.</p> 	
<p>B. Does the slide have an obvious “halo” of cellular material and/or white blood cells?</p> <p><b>NO</b> ↓     <b>YES</b> ⇒</p>	<p>1. Dilute the sample 20:1. Use a calibrated pipette to add 1 mL of sample to a new PreservCyt® Solution vial. Prepare slide using sequence Non-Gyn. If a halo is present on the new slide, call Hologic Technical Service.</p> 	
<p>C. Is the slide sparse and does it contain blood, protein, or non-cellular debris?</p> <p><b>NO</b> ↓     <b>YES</b> ⇒</p>	<p>1. Pour the contents of the PreservCyt sample vial into a centrifuge tube.</p> 	
<p>Call Hologic Technical Service.</p>	<p>2. Concentrate by centrifugation — 600 g for 10 min. (page 5.5) or 1200 g for 5 min.</p> 	
	<p>3. Pour off supernatant and vortex to resuspend cell pellet (page 5.7).</p> 	
	<p>4. If the sample contains blood or non-cellular debris:                      Mix a solution of 9 parts CytoLyt Solution to 1 part glacial acetic acid. Add 30 mL of this solution to the sample centrifuge tube.</p> <p>If the sample contains protein:                      Add 30 mL of saline to the sample centrifuge tube.</p> 	



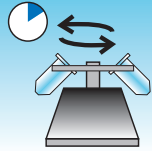
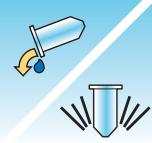

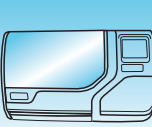
# 5

## NON-GYNECOLOGIC SAMPLE PREPARATION

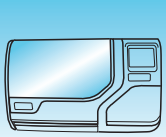
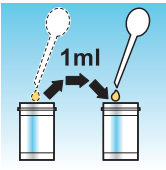
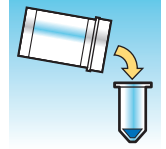
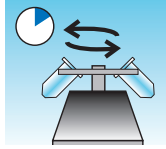
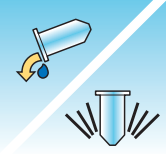

Problem	Procedure	
	5. Concentrate by centrifugation — 600 g for 10 min. (page 5.5) or 1200 g for 5 min.	
	6. Pour off supernatant and vortex to resuspend cell pellet (page 5.7).	
	7. Evaluate cell pellet appearance (page 5.9). If pellet contains blood or protein, repeat from step 4.	
	8. Add specimen to PreservCyt® Solution vial (page 5.10).	
	9. Run on ThinPrep® 5000 processor using Sequence Non-Gyn. Fix, stain, and evaluate.	
	10. If the new slide is sparse, call Hologic Technical Service (page 12.1).	

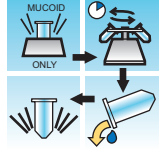
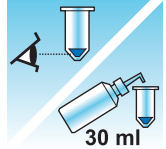
**Mucoid Specimens**

Problem	Procedure	
A. Did the “Sample Is Dilute” message appear during processing? <b>NO</b> ↓ <b>YES</b> ⇒	1. Check to see if cellularity is adequate. If not, use more of the pellet if available. Prepare a slide using Sequence Non-Gyn. 	
B. Does the slide have an obvious “halo” of cellular material and/or white blood cells. <b>NO</b> ↓ <b>YES</b> ⇒	1. Dilute the sample 20:1. Use a calibrated pipette to add 1 mL of sample to a new PreservCyt® Solution vial. Prepare slide using Sequence Non-Gyn. If a halo is present on the new slide, call Hologic Technical Service (page 12.1). 	
C. Is the slide sparse and does it contain mucus? <b>NO</b> ↓ <b>YES</b> ⇒	1. Pour the contents of the PreservCyt sample vial into a centrifuge tube. 	
Call Hologic Technical Service (page 12.1).	2. Concentrate by centrifugation — 600 g for 10 min. (page 5.5) or 1200 g for 5 min. 	
	3. Pour off supernatant and vortex to resuspend cell pellet (page 5.7). 	
	4. CytoLyt Solution wash (page 5.12)  	
	5. Evaluate cell pellet appearance (page 5.9). If pellet contains mucus, repeat from step 4. 	

# 5

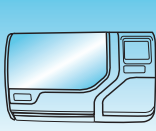
## NON-GYNECOLOGIC SAMPLE PREPARATION

Problem	Procedure	
	6. Add specimen to PreservCyt® Solution vial (page 5.10).	
	7. Run on ThinPrep® 5000 processor using Sequence Non-Gyn. Fix, stain, and evaluate.	
	8. If the new slide is sparse, call Hologic Technical Support (page 12.1).	

### Techniques Used in Troubleshooting

#### Diluting the Sample 20 to 1

To dilute a sample suspended in PreservCyt Solution, add 1 mL of the sample that is suspended in PreservCyt Solution to a new PreservCyt Solution vial (20 mL). This is most accurately done with a calibrated pipette.

You may also simply count drops from an uncalibrated plastic pipette if you know how many drops correspond to 1 mL. To calculate this, count out drops of PreservCyt Solution into a container of known volume. When the known volume is reached, divide the number of drops by the volume (in mL) to get the number of drops that corresponds to 1 mL. Use PreservCyt Solution rather than any other liquid so the drop size will be consistent with the sample drops.

#### Glacial Acetic Acid Wash for Blood and Non-Cellular Debris

If a sample is found to be bloody during microscopic review, it can be further washed using a solution of 9 parts CytoLyt Solution and 1 part glacial acetic acid. This should only be done after the sample has been in PreservCyt Solution. Do not use directly with fresh specimens; nuclear morphology may not be adequately preserved.



# Chapter Six

---

## User Interface

This chapter provides detailed information on the user interface screens and how to use them to operate, troubleshoot and maintain the ThinPrep<sup>®</sup> 5000 processor.

The content found in this chapter:

MAIN SCREEN, PROCESSOR IDLE .....	6.2
• Status Indicators .....	6.3
• Process Sequences .....	6.4
• Start Button .....	6.8
MAIN SCREEN, DURING PROCESSING .....	6.9
• Processing .....	6.9
• Pause a Batch .....	6.10
• Processing Complete .....	6.12
BATHS SCREEN .....	6.13
• Fixative Bath Status .....	6.13
• Baths Movement Commands .....	6.14
ADMINISTRATIVE OPTIONS .....	6.16
• About button .....	6.17
• System Settings .....	6.17
Set Date .....	6.19
Set Time .....	6.20
Lab Name .....	6.21
Instrument Name .....	6.22
Set Sound .....	6.23
Alert Tones .....	6.24
Language .....	6.25
Vial and Slide ID Pre-match .....	6.26
Install Printer .....	6.27
Configure Barcodes .....	6.41
LIS (Laboratory Information System) .....	6.41

# 6

## USER INTERFACE

- Reports and Logs ..... 6.42
  - System Events ..... 6.43
  - Batch Reports ..... 6.44
  - Batch Report Printout ..... 6.47
  - Save a Report to USB Key ..... 6.48
  - Usage Details ..... 6.51
  - Gather Diagnostics ..... 6.52
- Clean System ..... 6.53
- Clean Screen ..... 6.53
- Empty Liquid Waste ..... 6.53

### SECTION A

## MAIN SCREEN, PROCESSOR IDLE

When the ThinPrep® 5000 processor is powered on and ready for use, the main screen will be displayed.

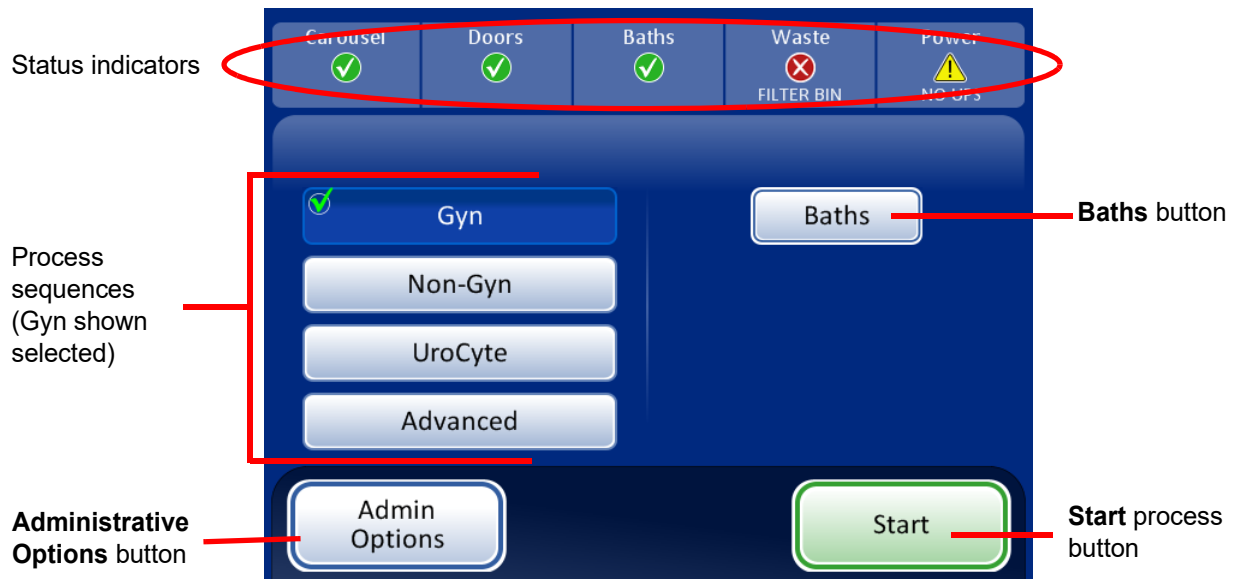













Figure 6-1 Main Screen

### Status Indicators

The status indicators are located at the top of the main screen display.

Touch the status indicator on the screen for a brief pop-up explanation of what the status means. A table of the status indicators is shown below.

**Table 6.1: Status Indicators**

CAROUSEL	DOORS	BATHS	WASTE	POWER
 Status OK, ready to process	 Status OK, ready to process	 Status OK, ready to process	 Status OK, ready to process	 Status OK, ready to process
 Carousel not detected. Insert carousel or make sure it is in position.	 One or both doors are open. Close the doors.	 A fixative bath is not detected. Insert a fixative bath and close the door.	 Press the icon to display a message regarding waste: <ul style="list-style-type: none"> <li>• <b>Filter waste bin is undetected or needs to be emptied. Remove, empty and reinsert waste bin.</b></li> <li>• <b>Liquid waste must be emptied. See page 8.6.</b></li> </ul>	 The system is running on battery power (UPS). If a batch is in process, it will finish the sample and pause the batch.
 The status of the carousel is unknown when the door is open.				 The UPS is not detected or battery is low in power.

**Carousel** - The system monitors whether an input carousel is present or not. If a carousel is present, the icon is a check mark. If an input carousel is not present, the icon is an 'X'.

**Doors** - The main door and the baths door must be closed in order to run the processor. If both doors are closed, the icon is a check mark. If either door is open the icon is an 'X'.

**Baths** - The system monitors whether a fixative bath is present. If a bath is present, the icon is a check mark. If a bath is not present, the icon is an 'X'.

**Waste** - The system monitors if the filter waste bin is present. If it is present, the icon is a check mark. If the waste bin is not present or if the liquid waste must be emptied, the icon is an 'X'.

# 6

## USER INTERFACE

**Power** - the system monitors that there is power to run the processor. If power is available the icon is a check mark. If the system is relying on the UPS for power, the icon is an 'X'.

**CAUTION:** If the system is relying on the UPS battery power (such as a power outage), there is a limited time in which there will be sufficient power to safely run the system. The processor should be shut down. If a batch is in process, interrupt it and elect to end the batch. (Refer to page 6.10.)

When the mechanisms have put all consumables away and the main screen displays, shut down the system according to the directions in section "TURN OFF THE THINPREP 5000 PROCESSOR" on page 2.6.

**WARNING:** Never disconnect the UPS wall plug when the processor is running on battery power. The processor needs to remain connected to ground through the UPS.

### Process Sequences

Prior to processing a batch, select the type of process sequence that will be run: gynecologic samples, non-gynecologic samples, UroCyte<sup>®</sup> samples. The **Advanced** button is for specific batch options (described below).

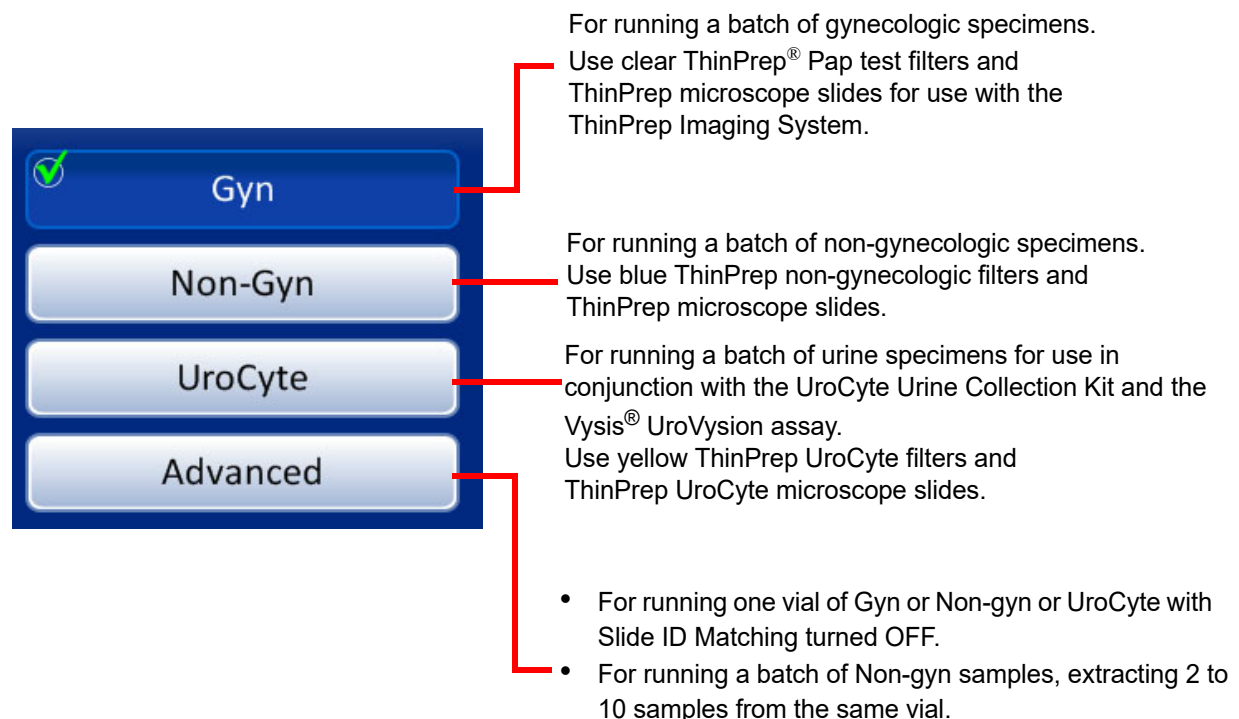
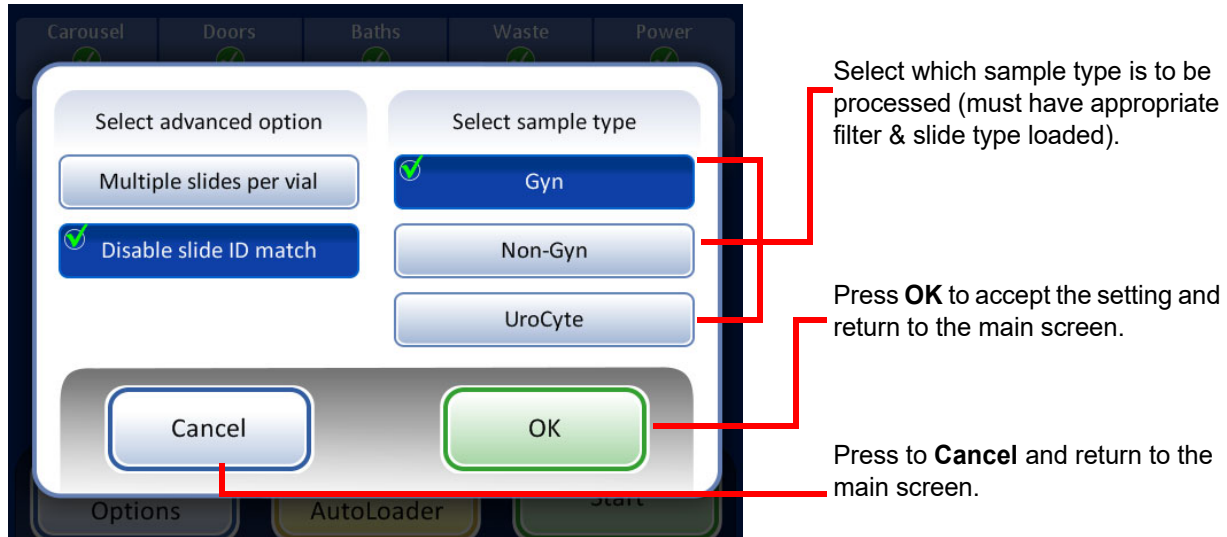

**Figure 6-2 Process Sequence Buttons**



## Advanced processing options

### Disable slide ID match



**Figure 6-3 Disable Slide ID Match**

**Disable Slide ID Match** allows you to run one sample with the vial/slide ID match turned off. One vial of any sample type may be processed: gynecologic, non-gynecologic or UroCyte®. A “Chain of custody is off” message displays on the screen during processing.

To run the specimen:

1. Load one vial and appropriate filter and slide type into any position on the carousel.
2. Load the carousel into the processor.
3. Put a filled fixative bath - with empty slide rack - into the bath compartment.
4. Empty the filter waste bin and return it to the processor.
5. Close all doors.
6. Press the **Advanced** button on the main screen.
7. Press the **Disable slide ID match** setting button.
8. Select the sample type that is to be processed and press the **OK** button.

**Note:** The display returns to the main screen, in order for you to press the **Start** button. **DO NOT** press any of the sequence buttons.

# 6

## USER INTERFACE

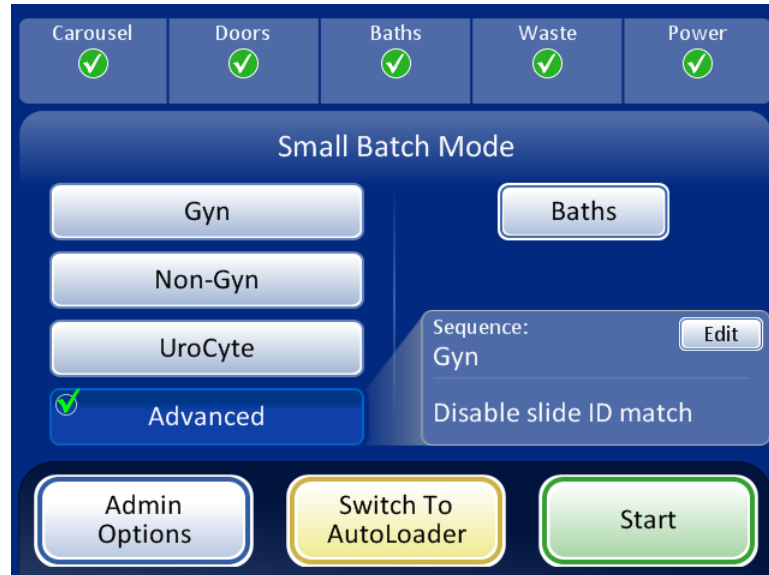
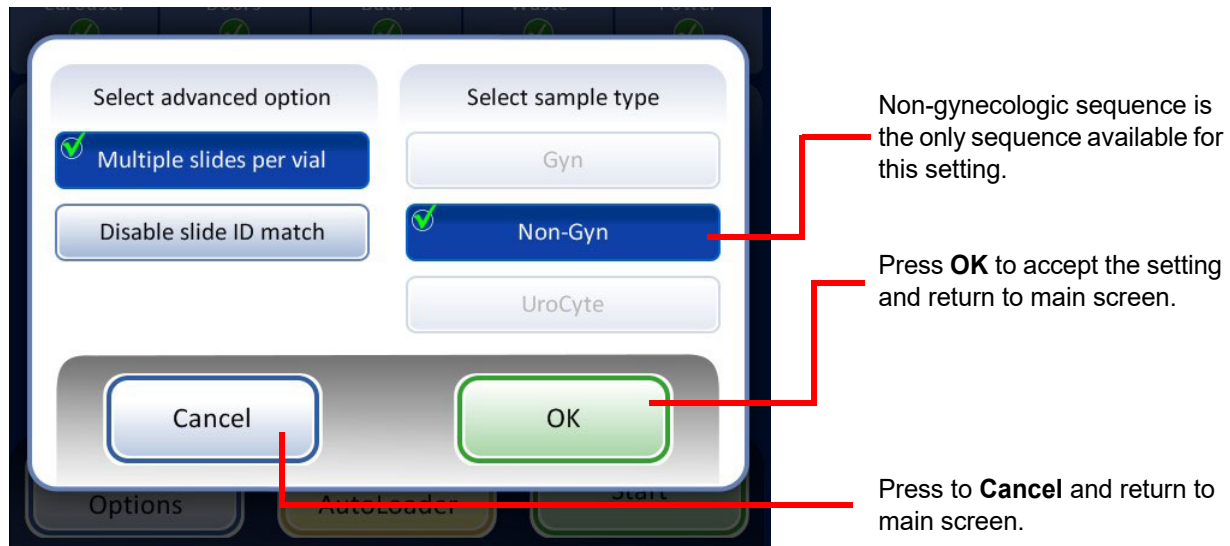

**Figure 6-4 Main Screen Showing Disable Slide ID Match Is Selected**

9. Press the **Start** button to process the sample.

**Note:** When the sample has been processed, the system reverts to Slide ID Match ON. To process another sample without the vial/slide ID match, repeat the steps above.

**Note:** Only one vial may be loaded into the carousel. Prior to processing, the instrument checks that it senses only one vial. If more than one vial is present, the batch will not proceed.

**Advanced processing options****Multiple slides per vial****Figure 6-5 Multiple Slides per Vial Screen**

**Multiple Slides per Vial** allows you to run a non-gynecologic specimen and extract from 1 to 10 samples from the same vial. The system will bypass the fluid level too low check when processing multiple slides per vial.

To process a sample:

1. Load a non-gynecologic sample vial into position 1 of the carousel. (Must be in position 1.)
2. Load a non-gyn filter into the filter slot and a slide into the slide slot. Load the adjacent filter and slide slots with the number of desired samples to be made (from 2 to 10).
3. Load a filled fixative bath - with an empty slide rack - into the baths compartment.
4. Empty and replace the filter waste bin.
5. Close all doors.
6. Press the **Advanced** button on the main screen.
7. Press the **Multiple Slides per Vial** setting button. (Note that the non-gynecologic sequence is the only choice.) Press the green **OK** button.

# 6

## USER INTERFACE



**Figure 6-6 Main Screen Showing Multiple Slides per Vial Is Selected**

8. Press the **Start** button to process the sample.

### **Start Button**

To begin a batch, press the **Start** button.

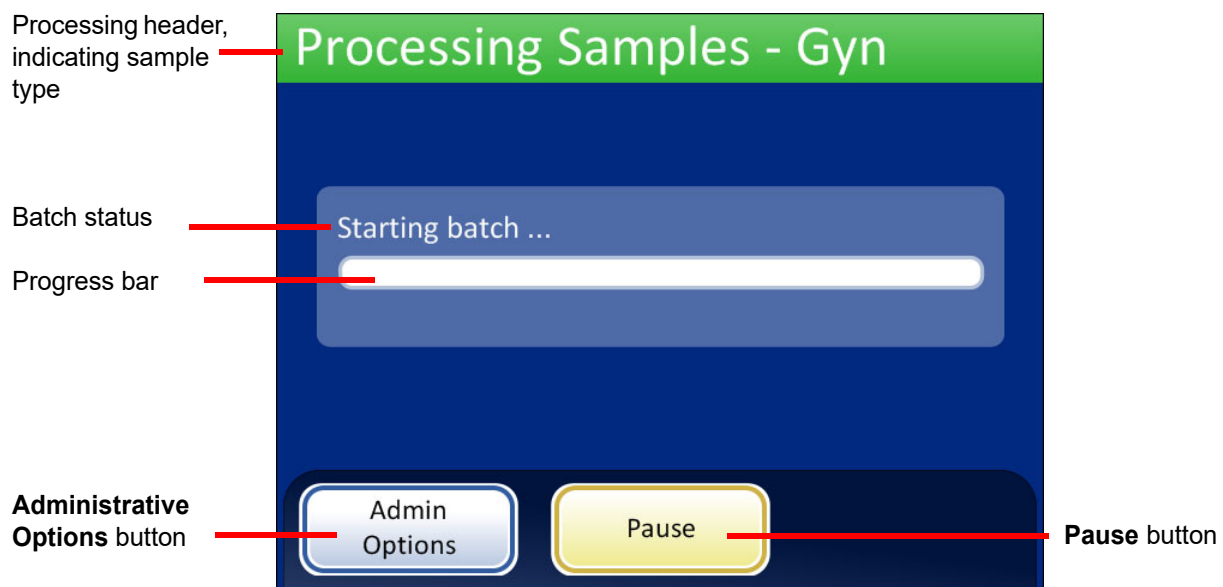

**Figure 6-7 Start Button**

## SECTION B MAIN SCREEN, DURING PROCESSING

### Processing

When the **Start** button is pressed, the doors can be heard to lock. The main screen changes to display the batch status, a progress bar, the **Admin Options** button and a **Pause** button, as shown below.



**Figure 6-8 Starting Batch Screen**

The carousel is rotated in front of an optical sensor and the system counts how many vials are present and which positions they occupy in the carousel.

The system then checks the vial and slide IDs.

If the **Vial & Slide ID Pre-match** setting is on (refer to page 6.26), the system then rotates the carousel and reads each vial ID and the corresponding slide ID. If any discrepancies are discovered, the system will pause for operator interaction.

If the **Vial & Slide ID Pre-match** setting is off, (refer to page 6.26), the system will begin processing, and will check if vial and slide IDs match as it processes each vial.

The batch begins, and the status line indicates which number vial is being processed. The progress bar indicates the progress for that vial. See Figure 6-9.

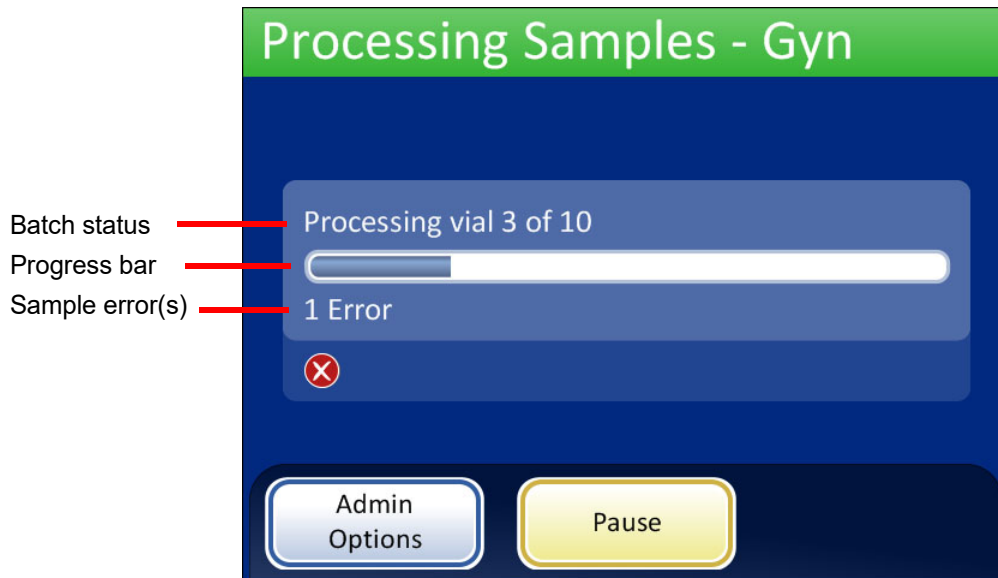

**Figure 6-9 Batch in Process Screen**

## Pause a Batch



**Figure 6-10 Pause Button**

A batch may be paused by pressing the **Pause** button.

When the **Pause** button is pressed, the system will complete processing the current vial and then pause.

The display header will change color and read "Interrupting" as the processor puts items away and parks the mechanisms. Refer to Figure 6-11.

The Paused screen will display when the processing sequence is safely paused. Only the bath door is unlocked. Refer to Figure 6-11.

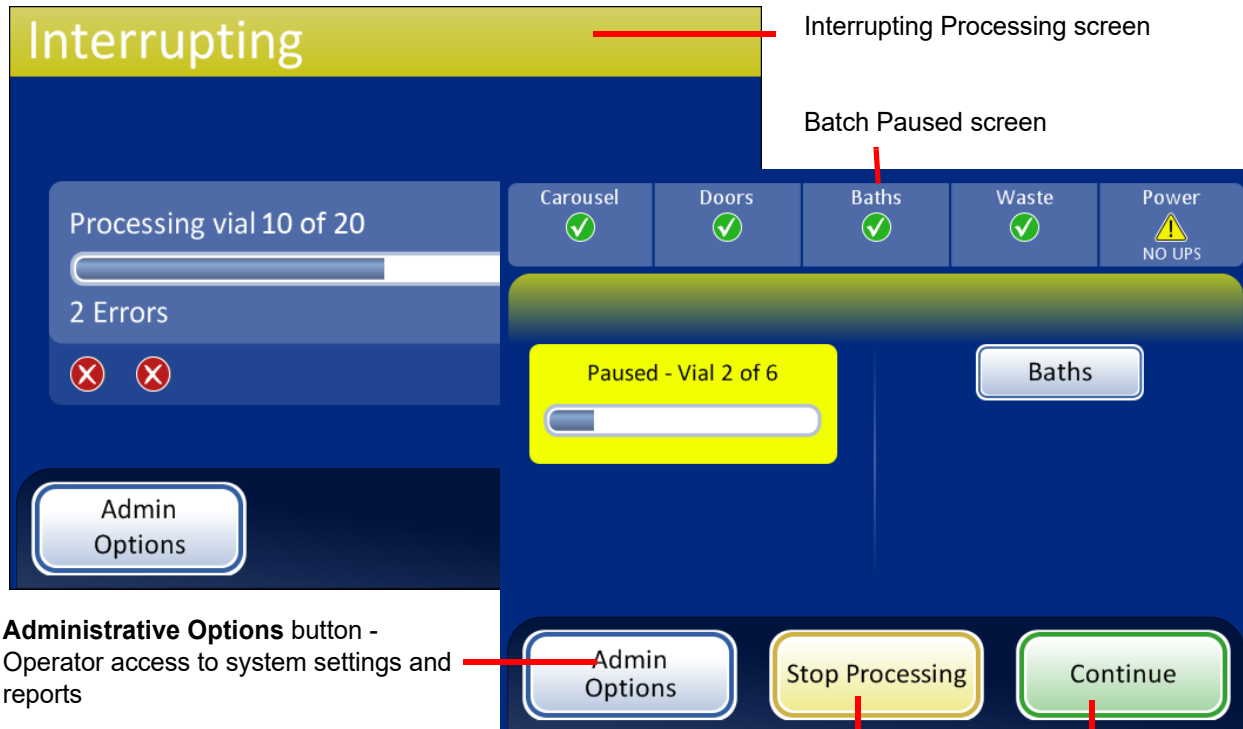

**Administrative Options** button - Operator access to system settings and reports

**Stop Processing** button - the batch is over.

**Continue** button continues with the batch in process.

**Figure 6-11 Processing Paused Screen**

While the batch is paused, only the baths area can be accessed.

Completed slides may be unloaded by removing the fixative bath from the baths compartment. If the batch will resume, a fixative bath with no slides must be loaded.

**Note:** If the fixative bath is slid out of the compartment slot far enough to disengage with the sensor, a new bath without any slides must be loaded in order to resume the batch. Otherwise the “No baths available” message will keep repeating.

Close the door and press the **Continue** button when ready to continue with the batch.

Press the **Stop Processing** button to end further processing for that batch. The Processing Complete screen will display. Refer to the next section.

## Processing Complete

When a batch has completed processing, the processor returns to an idle state, with a Processing Complete message on the screen. See Figure 6-12. The doors unlock. If an alarm sound has been set for batch completion, it will sound briefly.

To view the batch report, press the **Batch Report** button. The report will display and there is the opportunity to print the report or save it to USB key via that screen. When the report screen is exited (by pressing the Done button), you return to the Processing Complete screen. Refer to “Batch reports” on page 6.44.

The screen will remain until the operator acknowledges by pressing the **Done** button.

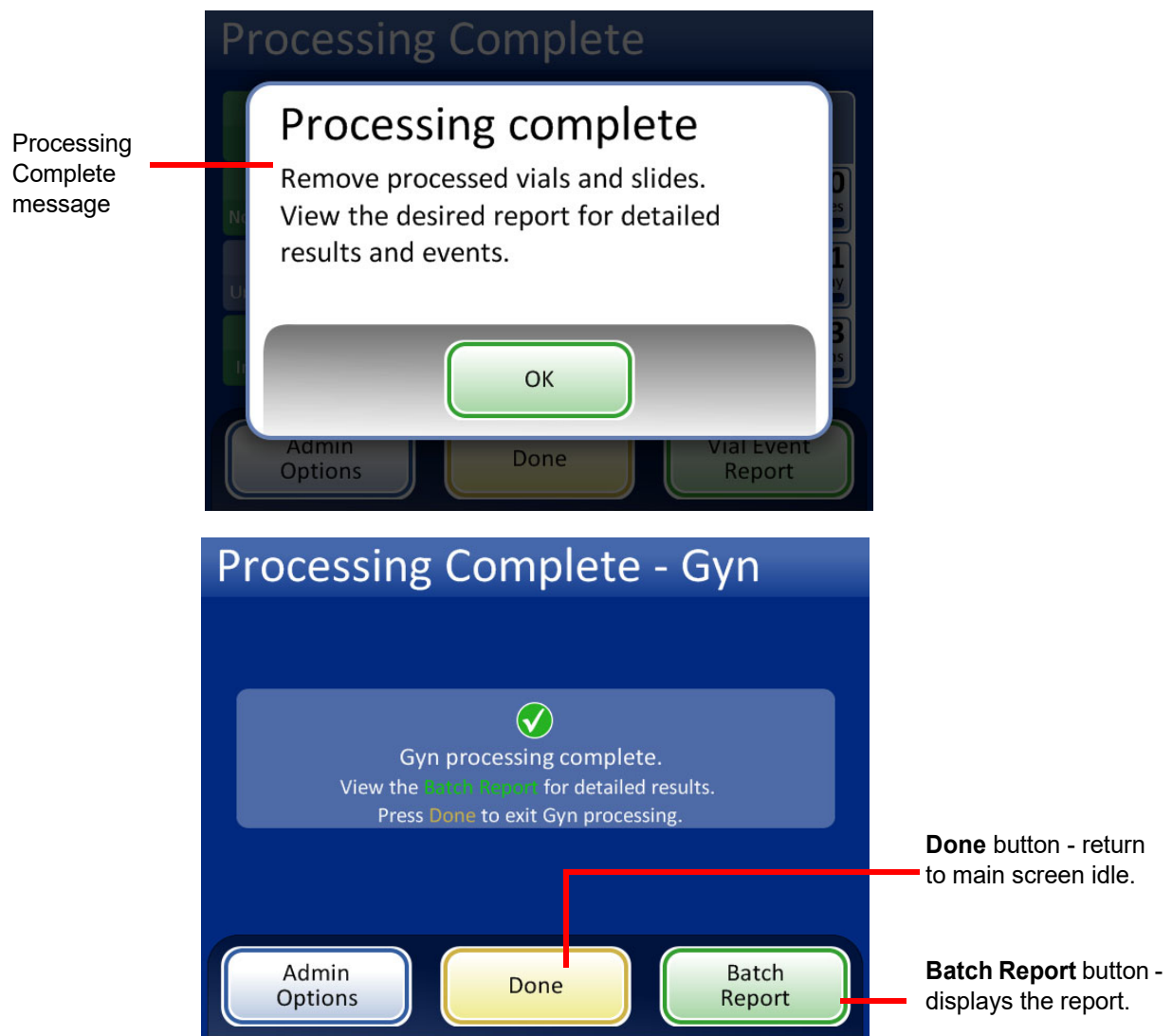

**Figure 6-12 Processing Complete Screen**



SECTION  
C

BATHS SCREEN

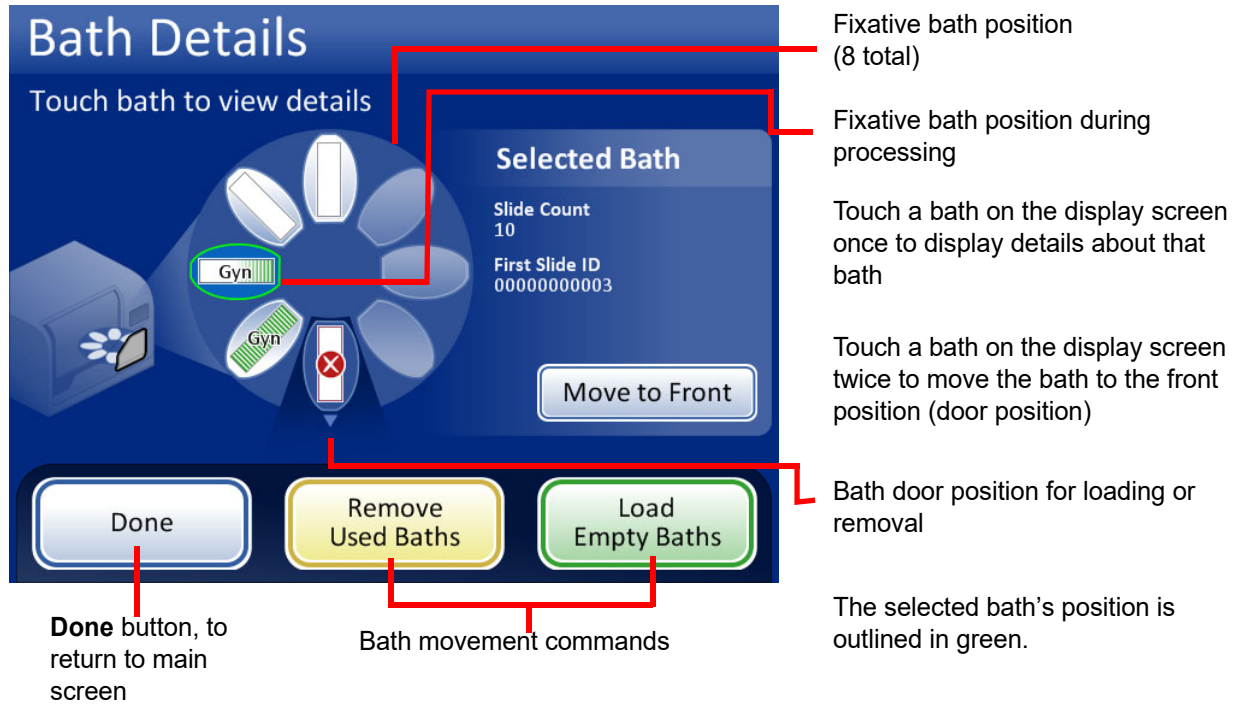

Figure 6-13 Baths Screen

**Fixative Bath Status**

The baths compartment has room for eight fixative baths. The processor continuously monitors the status of each bath position. The different status conditions are shown in Figure 6-14. The processor also provides details about the slides in a selected bath:

Slide count - The processor keeps track of the quantity of slides deposited in the slide rack in the selected bath.

First Slide ID - The ID of the first slide in the slide rack for the selected bath is displayed.

# 6

## USER INTERFACE

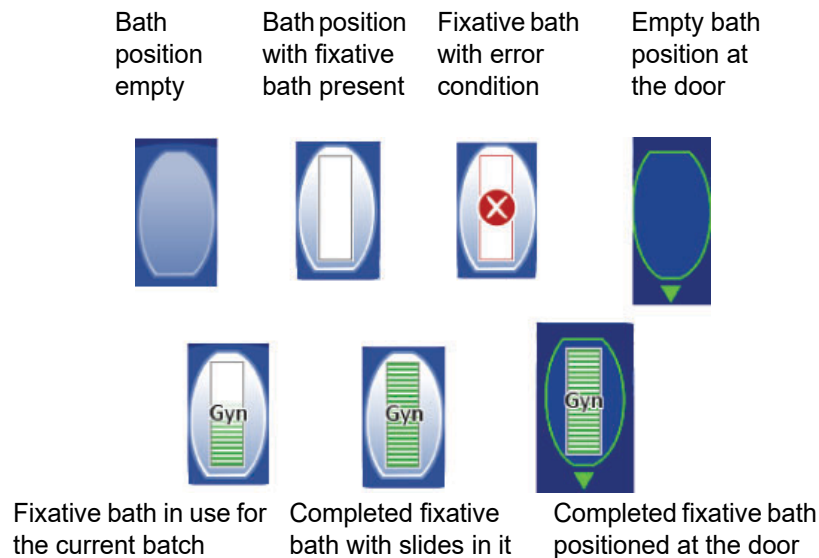
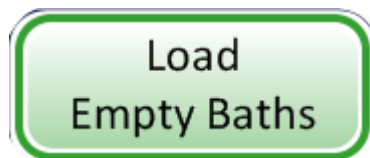

**Figure 6-14 Fixative Bath Status - Gyn Slides as Example**

### Baths Movement Commands



**Move to Front** - to move a fixative bath to the door, either touch the **Move to Front** button with the bath selected, or double-touch the position it occupies on the screen display. The system locks the door and moves the position in front of the door. When the door unlocks, it may be opened and the fixative bath removed.



**Load Empty Baths** - To load one or more fixative baths into the bath compartment, make sure the door is closed and press the **Load Empty Baths** button. The system locks the door and moves an empty bath position in front of the door. When the door unlocks, open it and slide the fixative bath with staining rack into the position. Close the door. The compartment rotates to the next empty position and then unlocks the door. Continue in this manner until the desired number of baths are loaded. Press the **Done** button when all baths are loaded.

**Note:** Be sure to remove the bath's evaporative cover before placing it into the processor.

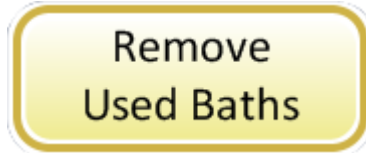

**Remove Used Baths** - to remove all completed fixative baths that are on board the instrument, press the **Remove Used Baths** button. The door locks and a completed bath is moved to the door. The door unlocks. Remove the bath and close the door. The door will lock and the next bath is delivered to the door and the door unlocks. Continue in this manner until all baths are unloaded. Press the **Done** button when the last bath is removed.

# 6

## USER INTERFACE

### SECTION D

## ADMINISTRATIVE OPTIONS

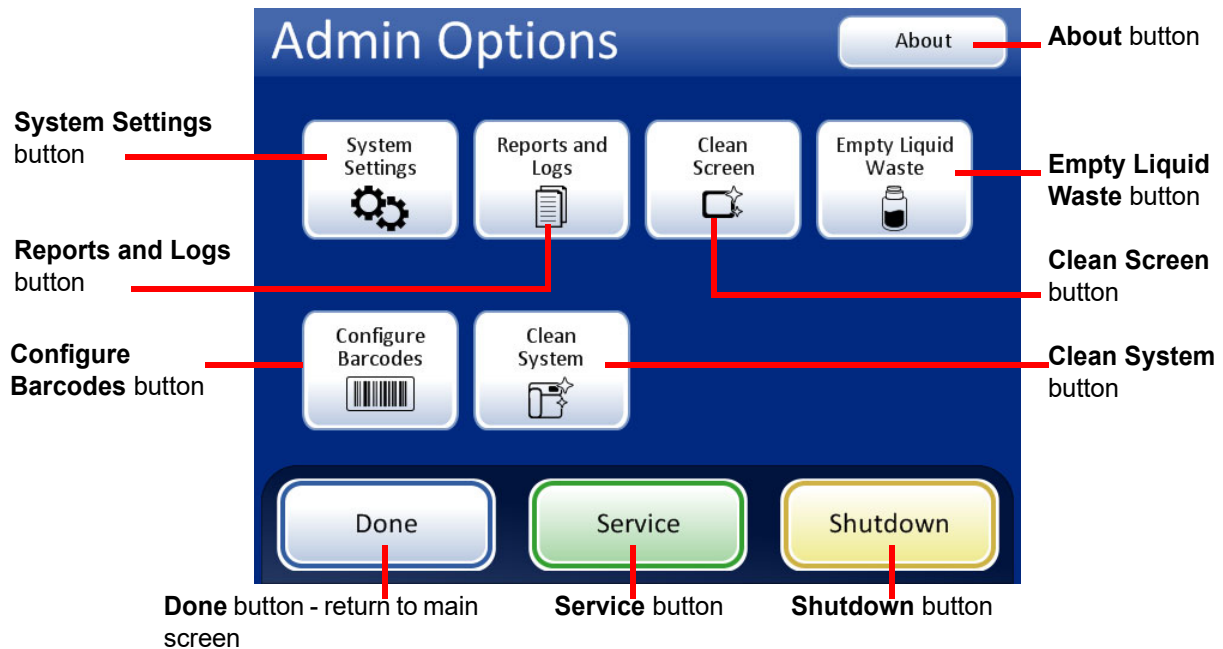

**Figure 6-15 Administrative Options Screen**

The Administrative Options screen allows user interface with the processor outside of processing samples. From this menu, the operator may:

- Apply or change system settings
- View system logs or print or save them to a USB device
- Disable the touch screen for cleaning
- Empty the liquid waste bottle
- Configure the rules that the processor uses to check vial IDs and slide IDs
- Move components into position for routine maintenance
- Shut down the instrument
- A Service button is available for Hologic service personnel usage and it is password-protected.



### **About Button**

Press the **About** button to display the serial number for the instrument as well as the software version information. The information displays for several seconds and then the Admin Options screen returns.



## USER INTERFACE

### System Settings

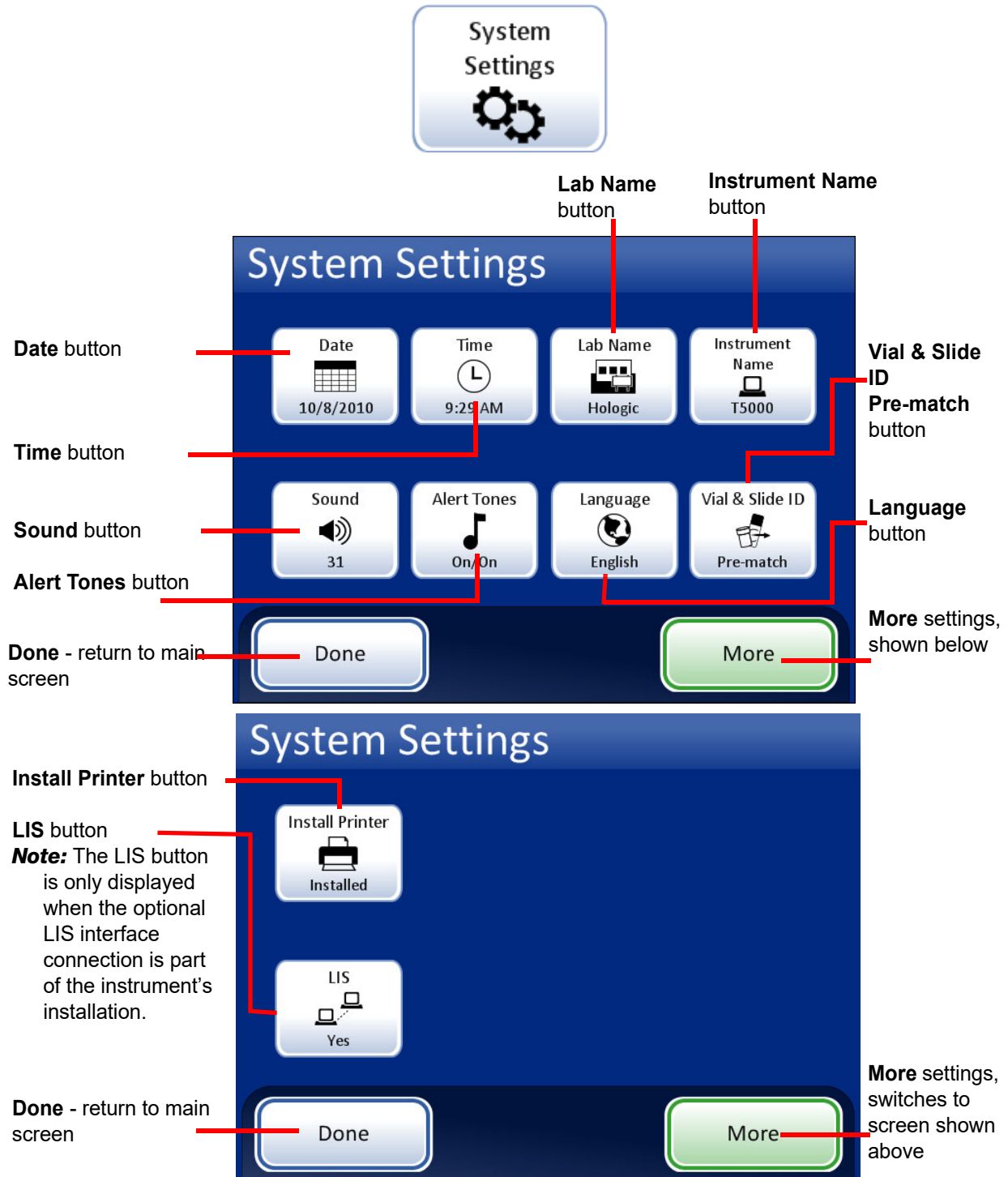

Figure 6-16 System Settings Screens

**Set date**

**Date** button shows current setting.

**Figure 6-17 Set Date Button**

To change the date (day, month or year) touch the up/down button for that field until the desired value is displayed. Press the **Save Changes** button to return to the System Settings screen. Press **Cancel** to cancel changes and revert to the previous setting. See Figure 6-18.



**Figure 6-18 Edit Date Screen**

**Note:** Depending on which language has been selected, the order of the month and day on the display may change to reflect customary usage.

# 6

## USER INTERFACE

### Set time

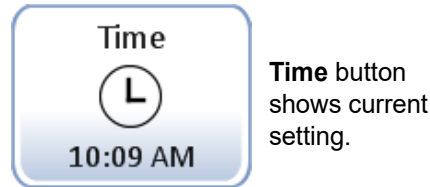

**Time** button shows current setting.

**Figure 6-19 Set Time Button**

To change the time (hour, minute, meridian), touch the up/down button for that field until the desired value is displayed. For the meridian, press the AM or PM button, as appropriate. Press the **Save Changes** button to save and return to the System Settings screen. See Figure 6-20.

**Note:** Depending on which language has been selected, the clock on the display may change from 12 hour to 24 hour, to reflect customary usage.

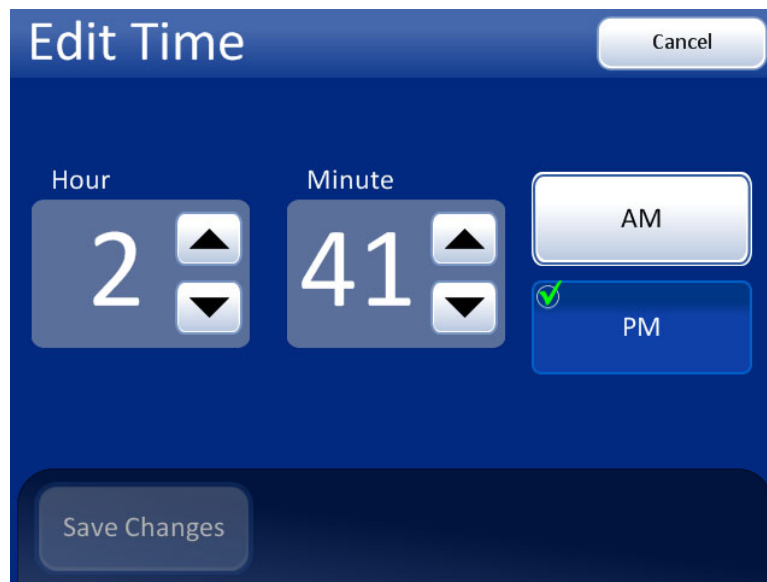

**Figure 6-20 Edit Time Screen**



**Lab name**

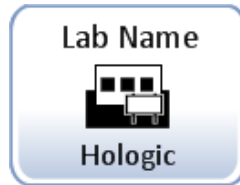

**Lab Name** button shows current setting.

**Figure 6-21 Set Lab Name Button**

To enter or edit a name for the facility at which the instrument is located, press the **Lab Name** button. Press the letter buttons to enter a name, up to 20 characters long. See Figure 6-22. To create a capital letter, press the **Shift** button and then press the letter. With the next letter, the system reverts to lowercase. Use the **Space** button for a space and the **Delete** button to remove entered letters.

Press the **abc/123** button to display a keypad screen to enter numbers and characters. Use the **Alt** key to enter characters on the top row. Switch between keyboard and keypad as often as desired before saving changes.

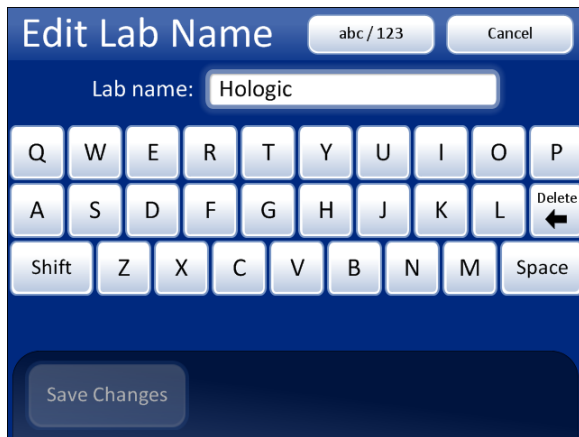

**Keyboard Display**

**Shift** for a capital letter

**Delete** to remove entries

**abc/123** to display numbers and characters

**Cancel** to return to System Settings screen. Reverts to previous entry (if any)

**Save Changes** to save the entry and return



**Numbers and Characters Display**

Use **Alt** for characters on the top row

**Delete** to remove entries

**abc/123** to display keyboard

**Cancel** to return to System Settings screen. Reverts to previous entry (if any)

**Save Changes** to save the entry and return to System Settings screen

**Figure 6-22 Edit Lab Name Keyboard and Keypad Screens**



## USER INTERFACE

### Instrument name



**Instrument Name** button shows current setting.

**Figure 6-23 Instrument Name Button**

To enter or edit a name for the ThinPrep 5000 processor, press the **Instrument Name** button. Press the letter buttons to enter a name, up to 20 characters long. See Figure 6-24. To create a capital letter, press the **Shift** button and then press the letter. With the next letter, the system reverts to lowercase. Use the **Space** button for a space and the **Delete** button to remove entered letters.

Press the **abc/123** button to display a screen to enter numbers and characters. Use the **Alt** key to enter characters on the top row. Switch between keyboard and keypad as often as desired before saving changes.

Press the **Save Changes** button to save and return to the System Settings screen.



**Figure 6-24 Edit Instrument Name Screen**

**Set sound**

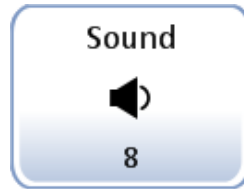

**Sound** volume button shows current setting.

**Figure 6-25 Sound Volume Button**

Audible alert tones can be set to signal batch completion and error condition. The volume of the audible alert tones may be increased or decreased using the Sound setting.

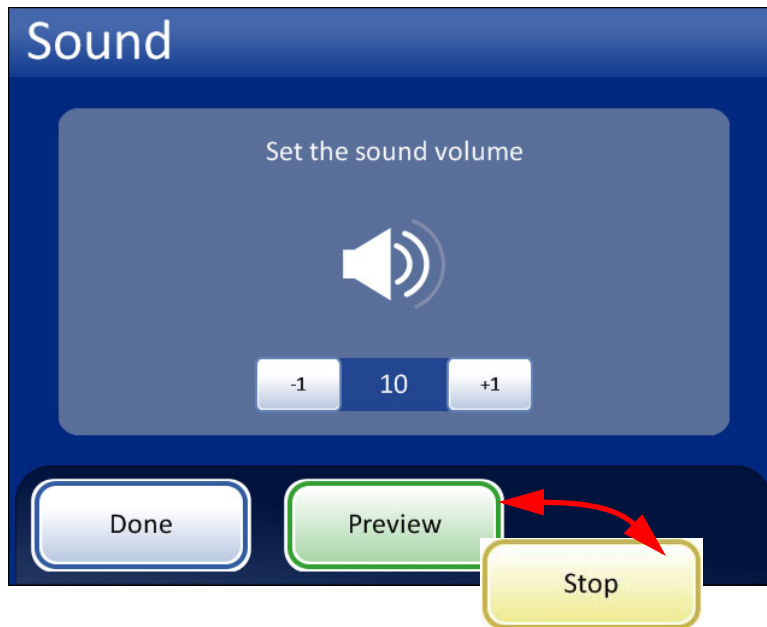

**Sound volume**  
Decrease  
Increase

**Done** - Save setting adjustment and return to System Settings screen

**Preview** - Press this button to hear the sound at the current volume. The button becomes a **Stop** button, which is pressed to cease the volume test.

**Figure 6-26 Sound Screen**

Press the **-1** button repeatedly to decrease the volume. Press the **+1** button repeatedly to increase the volume (0 to 31). Test it by pressing the **Preview** button to hear the sound. It will repeat until the **Stop** button is pressed. Continue to adjust and preview the sound volume until it is satisfactory. Press the **Done** button to save the setting and return to the System Settings screen.

# 6

## USER INTERFACE

### Alert tones



**Alert Tones** button shows the current setting.

**Figure 6-27 Alert Tones Button**

Alert tones are audible alarms that sound upon batch completion or during an error condition. Three sounds are offered for each. Select a tone or select the option to turn off any audible alarm for each condition.

**Note:** The volume of the tones is adjusted by the Sound screen. See the previous section.

Having differentiated tones makes it easier to know if the instrument has completed a batch or needs attention. In a setting that might have multiple machines, the different tones can help identify them.



Alert tones for batch completion

Alert tones for an error condition

Turn the option on, and then select a tone. Press the sound icon to hear the tone.

**Figure 6-28 Alert Tones Screen for Batch Completion and Error Condition**

When a batch completes, the alert tone will sound once.

When an error condition occurs, the alert tone will sound and then repeat every few seconds. The error message window will have a **Silence Alarm** button that can be pressed to turn the alarm off. (Figure 6-29.)

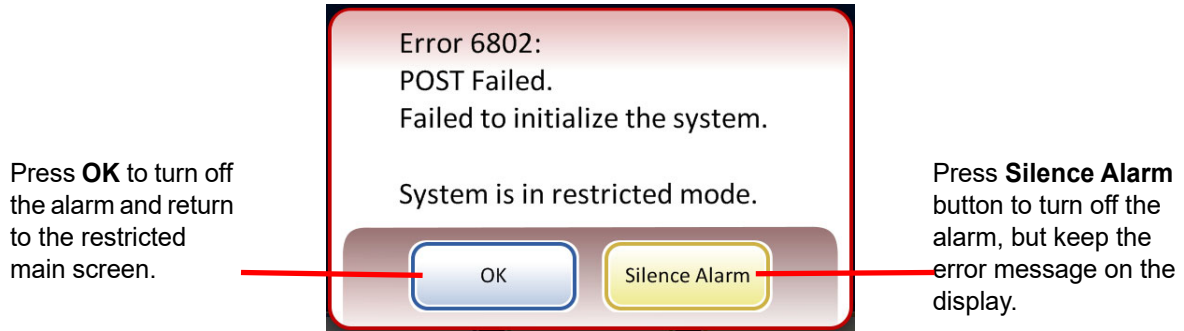

**Figure 6-29 Silence Alarm Button**

**Language**

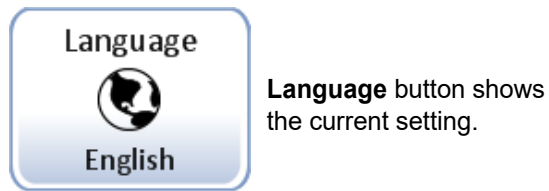

**Figure 6-30 Language Button**

Press the **Language** button to select the language that is displayed on the user interface and on the reports.

# 6

## USER INTERFACE



**Figure 6-31 Select Language Screen**

Select a locale for the language. This will apply customary time and date format for that region to the language.

Press the **Save Changes** button to immediately apply the selected language and locale to the system.

### Vial & slide ID pre-match



The **Pre-match** button shows the current setting.

**Figure 6-32 Vial & Slide ID Pre-match Button**

If **Vial & Slide ID pre-match** is selected the system will check the match between each vial/slide ID set in the carousel before beginning to process the batch.

If any of the vial/slide IDs do not match, a dialog box appears, listing the carousel positions of the discrepant vial/slide IDs. See Figure 6-33.

Press **Stop Processing** to cancel the batch and unlock the doors so that the mismatches can be corrected. The window will remain so that the vials and slides can be easily found.

Press **Continue Processing** to proceed with the batch. The vial/slides that are mismatched will not be processed.

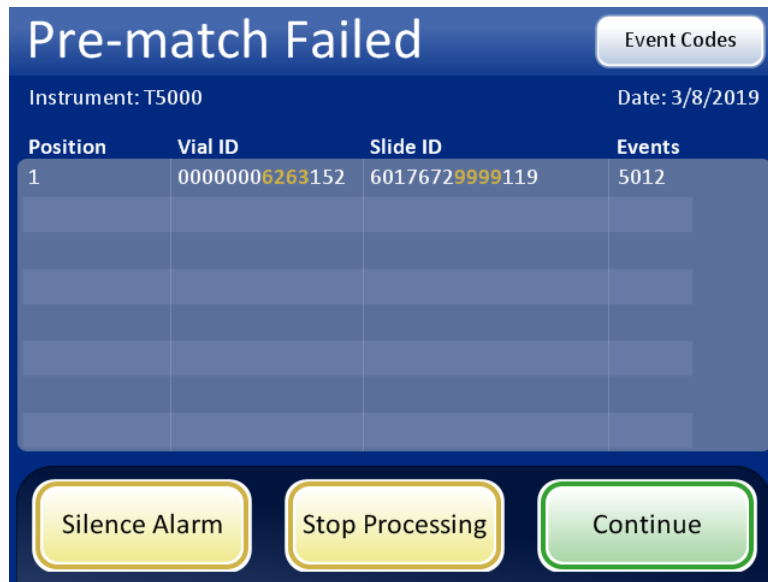

**Figure 6-33 Pre-check Failed Screen**

If **Vial & Slide ID pre-match** is not selected the system will check the match between each vial and slide set as it gets to them during processing. A mismatch of the IDs will cause the system to skip the vial and proceed to the next vial that has a matching slide ID.

**Install printer**



**Install Printer** button shows the current setting.

**Figure 6-34 Install Printer Button**

If a network printer is installed as part of your system, this function will search the network for its presence and connect to it at the time of setup. If a printer is not installed, or is unavailable to the system, a message will display that a printer could not be found. See Figure 6-35.

# 6

## USER INTERFACE

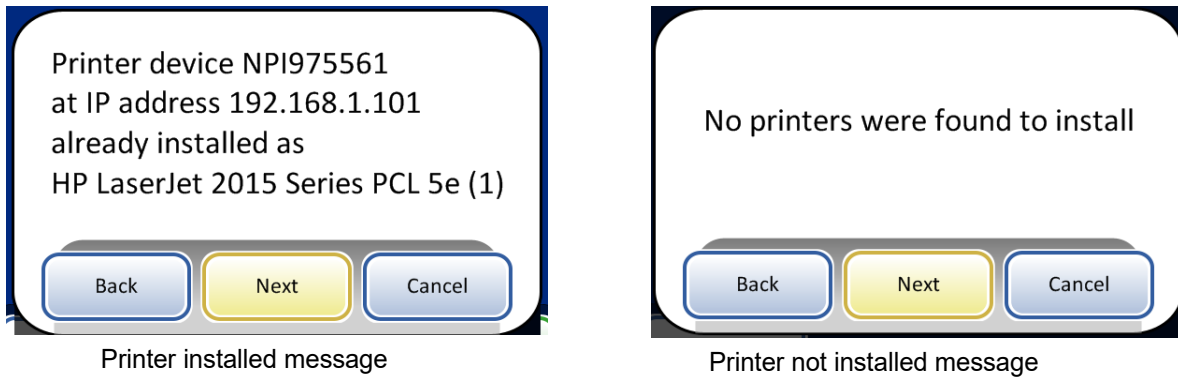

**Figure 6-35 Install Printer Messages**

**Note:** Multiple instruments may be connected to a single printer.

### Configure Barcodes



The ThinPrep 5000 processor compares the vial ID with a slide ID. The Configure Barcodes option establishes the ways that the processor will compare the ID information.

The Configure Barcodes settings are a series of questions about how sample vials are labeled when the vials are prepared for processing and a series of questions about how a slides are labeled in your laboratory.

**Note:** Some barcode configuration options described in this operator’s manual may not appear on the screen display for an instrument. The screen display only shows the options available for that particular instrument. For example, ThinPrep 5000 processors with a particular scanner installed cannot read 2-D barcodes on vial labels, and a particular scanner reads a maximum of five types of 1-D barcodes in vial labels.

The Configure Barcodes settings require that a portion of the information in a vial ID is also used on a slide label. The vial ID can be the same ID that is used on a slide. The slide ID must be a minimum of 5 characters and a maximum of 64 characters, but the format used for the slide ID adds its own requirements. For example, in the OCR: Imager format, the slide ID must be 14 characters. Generally,



the 2-D barcode formats can use more characters in the slide ID than the 1-D barcode or OCR formats.



**Figure 6-36 Configure barcodes screen**

There are separate sections for configuring the vial ID and the slide ID. In each section, information about the IDs must be entered. Each section ends with a screen with a Test Configuration or Test Settings button that lets the instrument scan example labels from a vial and/or slide to check that the ThinPrep 5000 processor is configured to read the ID labels used in your lab. The screen displays are designed to guide the operator through the sequence of steps to configure all of the barcode information. The sequence of steps is different if the slide IDs are exactly the same as the vial IDs than if the slide ID and vial ID only share a portion of their IDs. Each of the steps is described below.

### **Configure Vial ID**

The ThinPrep 5000 processor can be set up to read vial IDs as 1-D barcodes or 2-D barcodes.

The vial label must be in one of six 1-D barcode symbologies supported (Code 128, Interleaved 2 of 5, Code 39, Code 93, Codabar or EAN-13/JAN) or in one of the two 2-D barcode symbologies supported (DataMatrix or QR Code). No OCR vial label formats may be used.

# 6

## USER INTERFACE

Select 1-D barcode or 2-D barcode, and then select the type(s) of barcodes used for vial IDs at your facility.



**Figure 6-37 Configure Vial ID barcode type(s)**

**Note:** For best performance, select only the barcode type(s) that are used for vial IDs in your laboratory, and do not select barcode types that are not used in your lab.

The ThinPrep 5000 processor can be set up to use the entire vial ID as the slide ID, or it can be set up to recognize a portion of the vial ID for use in the slide ID.

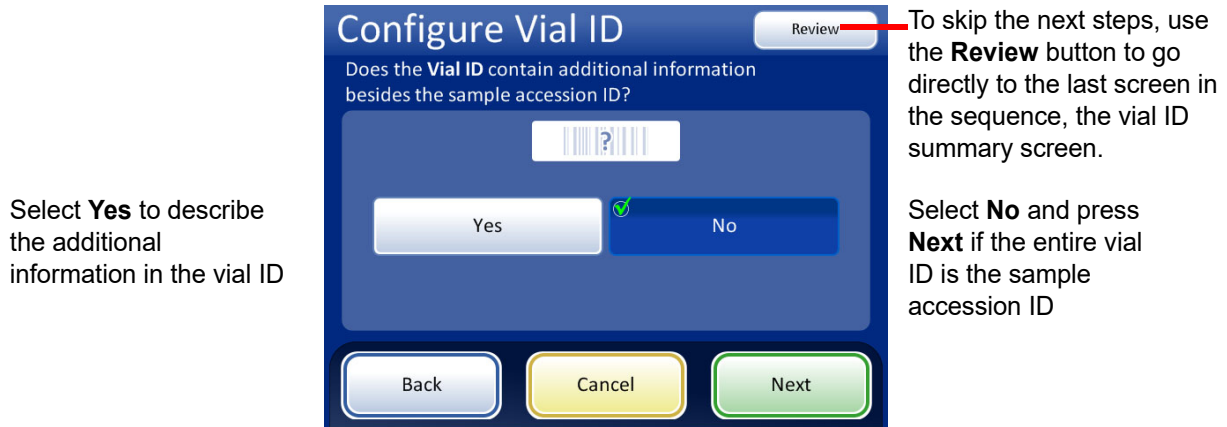

**Figure 6-38 Additional information in the vial ID besides the sample accession ID**

If the vial ID contains additional information besides the sample accession ID, configure the ThinPrep 5000 to recognize where the accession ID is within the vial ID.

**Note:** The accession ID in the vial ID is the portion of the vial ID that is used to configure the slide ID. See “Configure Slide ID” on page 6.34 for more information.

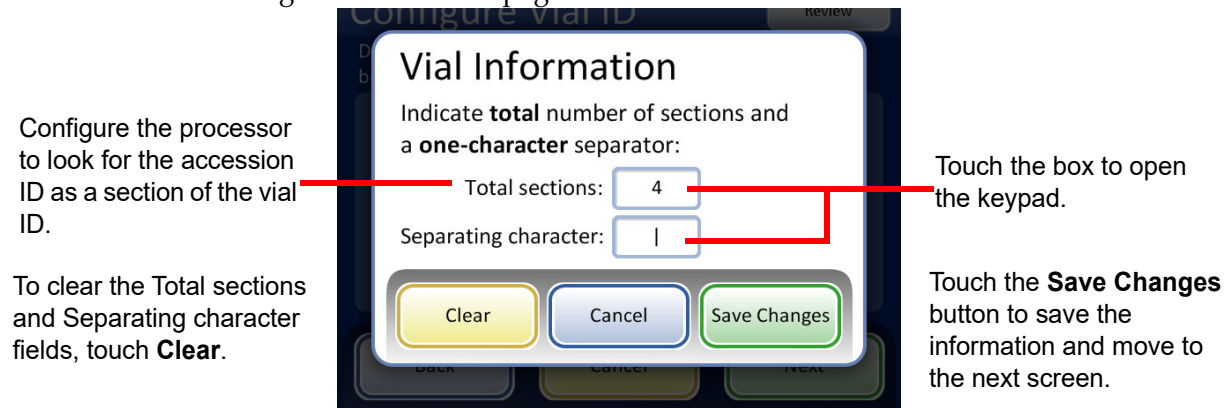

**Figure 6-39 Vial information screen**

Enter the total number of sections and a one-character separator. The total number of sections must be between two and four. For example, if a vial ID always starts with data that is not the accession ID, the ThinPrep 5000 processor can be configured to consider the vial ID as two segments: “Field 1” and the accession ID.

Touch the box to the right of the text to open the keypad. Enter the number or character and press **Done** to return to the Vial Information screen. Press the **Save Changes** button to save and return to the Configure Vial ID screen. The Configure Vial ID screen now displays the number of sections.

# 6

## USER INTERFACE

Touch the position of the section where the accession ID is. In this example, the vial ID starts with the accession ID and has three additional fields. In this example, the accession ID and the three additional fields are separated by a “|” (vertical line) character.

The screen display shows the number of sections and the position of the accession ID within the vial ID.

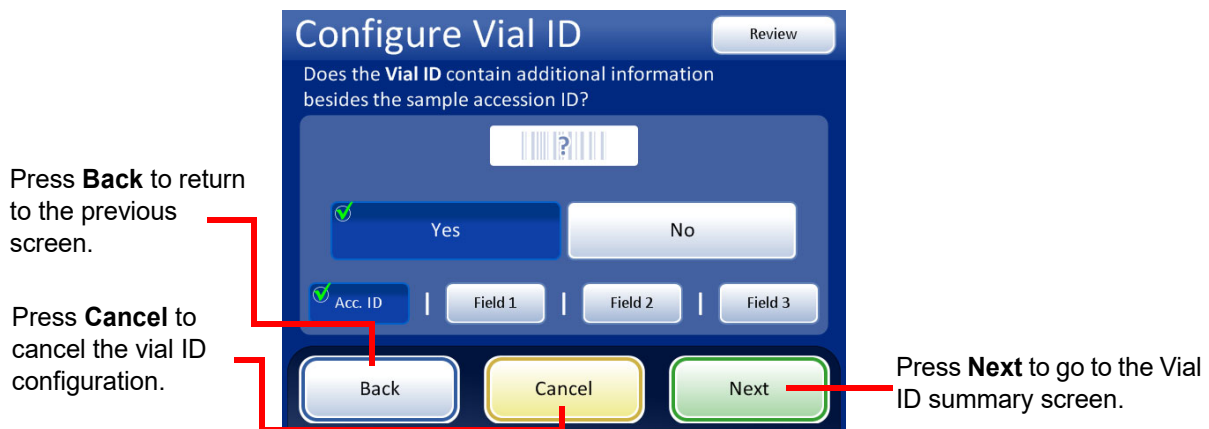

**Figure 6-40 Accession ID and additional information within the vial ID.**

Review the summary of the vial ID configuration. To save the configuration, press Save Changes. To change a setting, use the Back button. To check that the vial ID configuration matches vial IDs in your laboratory, press the Test Settings button.

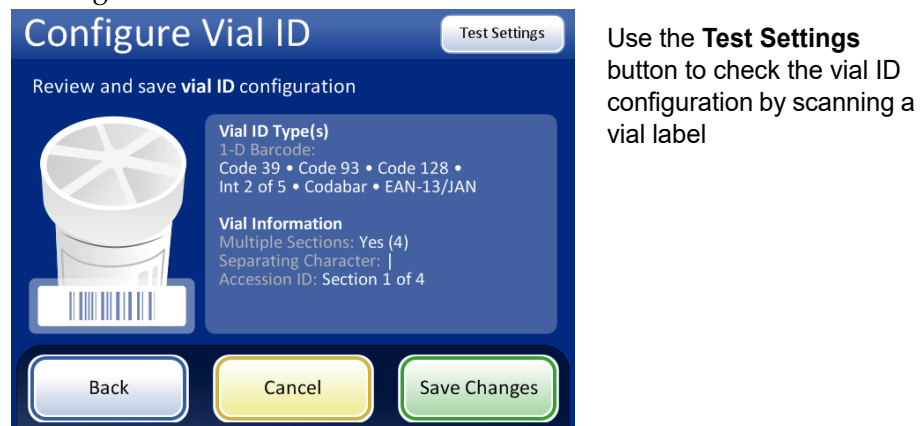

**Figure 6-41 Configure vial ID summary screen**

To test the vial ID configuration, use a labeled vial. Place the labeled vial into slot 1 of the input carousel. Close the doors and press Continue to scan.

The instrument removes the vial from slot 1 of the carousel and scans the vial ID to check that the scanned ID matches the vial ID barcode configuration set up on the instrument.

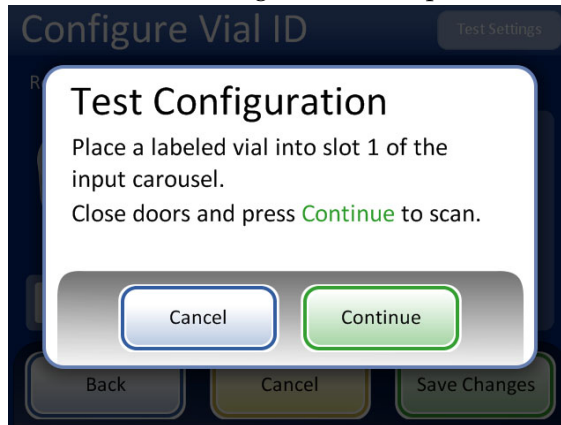

Successful Vial ID configuration. The vial ID configuration information matches the vial label that was scanned. In this example, the vial ID has an accession ID is “60” and there are two additional fields in the vial ID besides the accession ID. This configuration matches a vial printed with “60|7672999|9” on the vial label.

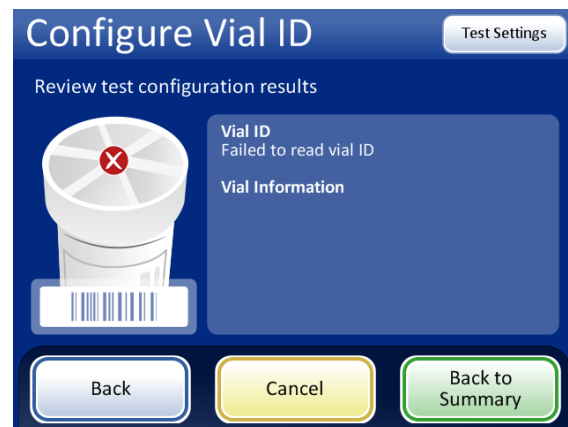

If the vial ID on the vial does not match the criteria configured for the vial ID, the screen display reports that the instrument failed to read the vial ID. Correct the vial ID on the label or correct the vial ID configuration before processing samples.

**Figure 6-42 Test vial ID settings**

When the vial ID is properly configured, return to the summary screen and save the changes.



## USER INTERFACE

### Configure Slide ID

Configure the type of barcode(s) used on the slide labels so that the ThinPrep 5000 processor recognizes the vial ID and slide ID from other information that may be printed on the labels. A barcode or OCR format must be used for the slide ID.

Slide labels may be printed and applied or directly printed or etched onto the slide, but make sure the contrast is sufficient for the scanner to read the label.

### OCR: Imager slide IDs

The format is always numeric characters only, 7 digits over 7 digits. This must be used if slides are being processed for use on the ThinPrep<sup>®</sup> Imaging System Imaging Station.

OCR Imager format must be 14-digits long in two rows, 7 digits over 7 digits, with the patient ID being 11 digits and a 3-digit CRC at the end. If the length is between 5–11, zeroes are prefixed as needed to form an 11-digit number. If the length is 12 with a leading zero, it is accepted by removing the leading zero. The font must be 12 point OCR-A. Numbers only, no alpha characters.

**Note:** For OCR Imager format, '9999' as the last 4 digits before the CRC are reserved for field service use. Slide IDs with those reserved numbers are removed from the patient database during a service visit, so do not use that sequence.

### OCR Non-Imager slide IDs

OCR Non-Imager format must be between 5 and 14 digits. Numbers only, no alpha characters.

### Barcode slide IDs

Slide barcode labels may be 1- or 2-dimensional; see the table below for any restrictions required.

**Table 6.2: Slide Restrictions Based on Vial Barcode Symbology Used**

1-D Code 128	All printable ASCII 128 characters are supported. The barcode width varies with content. Max. of 8 alphas or 14 digits will fit on a slide. Mixing will shorten the max. length.
1-D EAN-13/JAN	Supported characters are 0–9. The code must be 13 digits.
1-D Codabar (NW7)	Supported characters are - + \$ / : . and digits 0–9. A maximum of 9 characters will fit on a slide.
1-D Interleaved 2 of 5	Only digits are supported. A maximum of 14 digits, including an optional check digit, will fit on a slide.
1-D Code 39	Supported characters are A–Z, 0–9, - + . \$ / % 'space' Maximum of 6 characters will fit on a slide.
1-D Code 93	All printable ASCII 128 characters are supported. A maximum of 8 characters will fit on a slide.
2-D QR Code	All printable ASCII 128 characters are supported.
2-D DataMatrix	All printable ASCII 128 characters are supported. A maximum of 14 characters is supported.

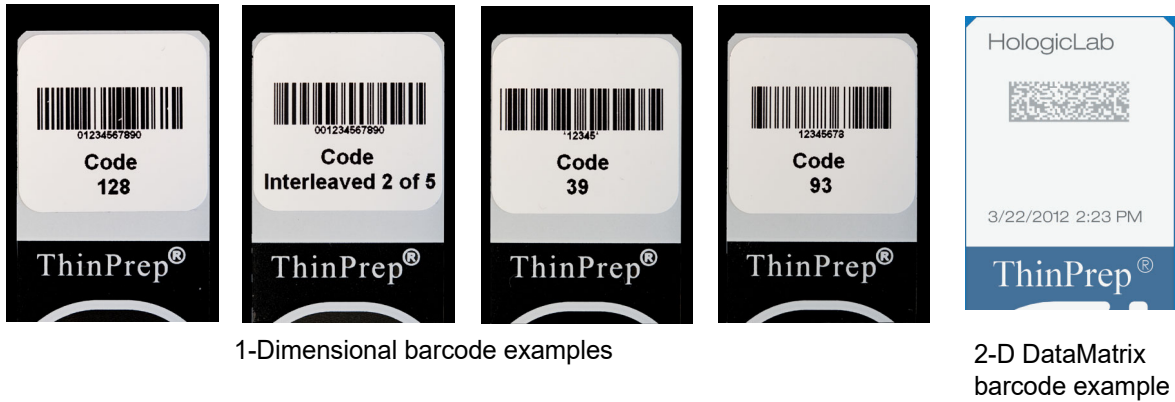

**Figure 6-43 Examples of How Barcodes Fit onto a ThinPrep Slide**

Touch the ID type to select it: 1-D Barcode, 2-D Barcode, OCR: Imager, or OCR: Non-Imager



**Figure 6-44 Specify the pre-labeled Slide ID type**

Press **Next** to continue.

# 6

## USER INTERFACE

For 1-D barcodes, touch an ID type to select it.

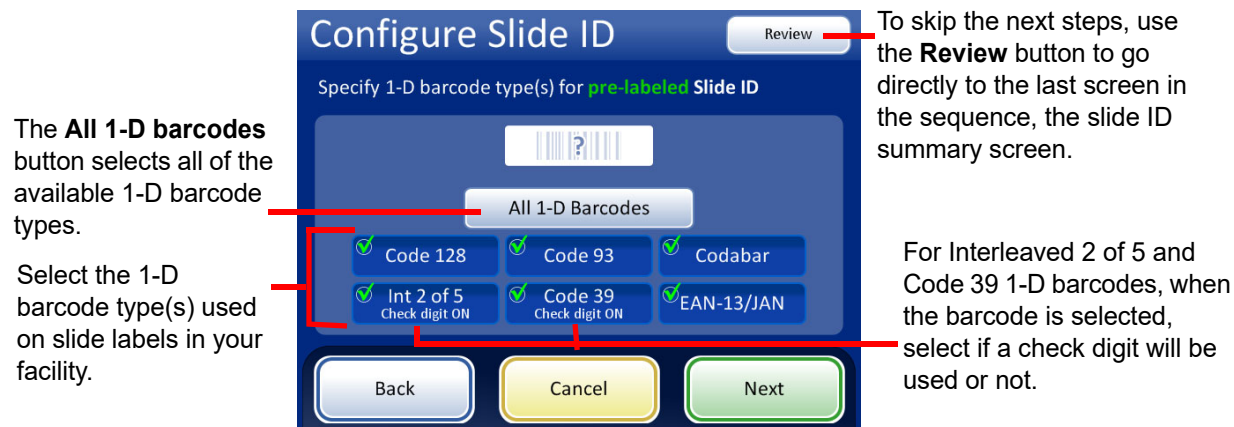

**Figure 6-45 Specify the 1-D barcode type(s) for pre-labeled Slide IDs**

Press **Next** to continue.

For 2-D barcodes, touch an ID type to select it.

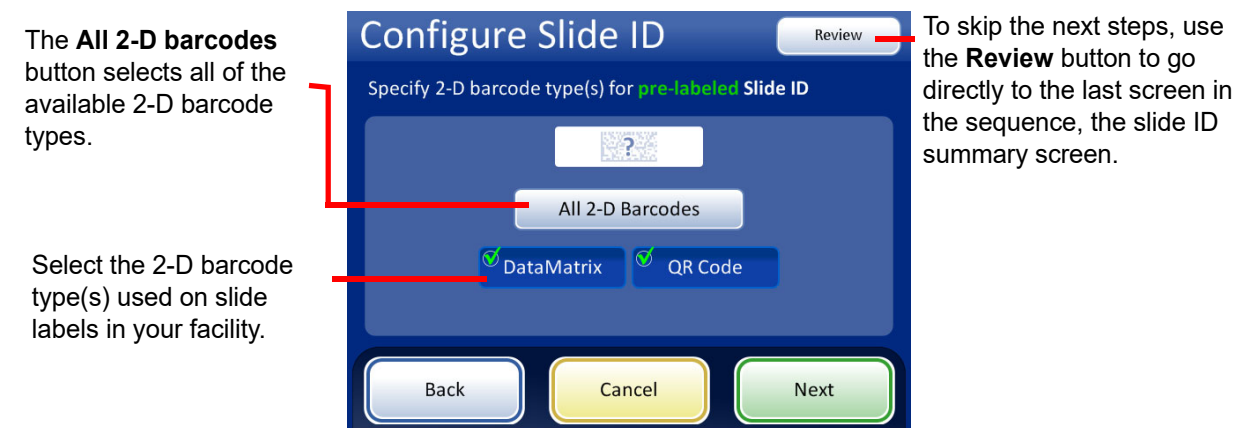

**Figure 6-46 Specify 2-D barcode type(s) for pre-labeled Slide IDs**

Press **Next** to continue.

The slide ID and the vial ID can be identical, or they can differ. The slide ID and the vial ID must share a unique portion of their IDs. Specify whether they are identical or where the slide ID and vial ID differ so that the ThinPrep 5000 processor recognizes a match between the vial ID and slide ID



and distinguishes the vial ID and slide ID from other information that may be printed on the vial label and/or slide label.

If all of the vial's accession ID (vial ID) is used in the slide ID, select **Entire ID**.

If only a segment of the vial's accession ID (vial ID) is part of the slide ID, select **Segment of ID** and then specify where that segment starts and finishes.

If all of the slide ID matches the vial's accession ID (vial ID), select **Entire ID**.

If only a segment of the slide ID is the vial's accession ID (vial ID), select **Segment of ID** and then specify where that segment starts and finishes.

**Figure 6-47 Matching between Vial ID and Slide ID**

If the vial ID contains additional information that is not part of the slide ID, indicate how to identify the segment of the vial ID to use for matching vial IDs and slide IDs.

If the slide ID contains additional information that is not part of the vial ID, indicate how to identify the segment of the slide ID to use for matching the vial IDs and slide IDs.

The steps for configuring the instrument to recognize a segment of the vial ID and the slide ID are the same. Refer to "Segment of ID" below.

Configure both the way that the vial ID matches the slide ID and the way that the slide ID matches the vial ID.

### Segment of ID

These instructions describe how to specify how a segment of a vial ID matches a slide ID. The instructions are the same for specifying how a segment of a slide ID matches a vial ID.

1. Touch the **Segment of ID** button.
2. Indicate where, in the vial ID, the segment that is used on the slide ID starts.  
If the first character of the segment to use in the slide ID is the first character of the vial ID, leave the "Start at position" field blank.



## USER INTERFACE

If the starting point is a certain position in the vial ID, such as the fifth character, use the “Start at position” setting.

- A. Touch the empty box to access the keypad.
- B. Use the keypad to enter the number that represents the position of the character which is the start of the segment of the vial ID used in the slide ID, such as “5” for the fifth character.

If the starting point of the segment of the vial ID used in the slide ID is a certain character, touch the triangle next to “Start at position” to see the “Start at character” field.

- A. Touch the name **Start at character** to select it.
- B. Touch the empty box to access the keypad.
- C. Use the keypad to enter the character that starts the segment of the vial ID used in the slide ID. This character is treated like a boundary, and this character is not included when the segment of the vial ID is used in other areas of the Configure Barcodes settings.
- D. Press **Done** to close the keypad.

### 3. Indicate where, in the vial ID, the segment that is used on the slide ID ends.

If the end of the segment to use in the slide ID is the end of the vial ID, leave the “Segment length” field blank.

If the ending point of the segment of the vial ID used in the slide ID is always the same number of characters from the starting point of the segment, use the “Segment length” field.

- A. Touch the empty box to access the keypad.
- B. Use the keypad to enter the character that ends the segment of the vial ID used in the slide ID.

If the ending point of the segment of the vial ID used in the slide ID is a certain character, touch the triangle next to “Segment length” to see the “End at character” field.

- A. Touch the name **End at character** to select it.
- B. Touch the empty box to access the keypad.
- C. Use the keypad to enter the character that ends the segment of the vial ID used in the slide ID. This character is treated like a boundary, and this character is not included when the segment of the vial ID is used in other areas of the Configure Barcodes settings.
- D. Press **Done** to close the keypad.

Press **Save Changes** to save the details.

The Configure Slide ID screen shows a summary of the pre-labeled Slide ID setting. To test that the settings for the pre-labeled slide ID configuration are correct for your facility, press the Test Settings button.



Use the **Test Settings** button to check the vial ID and slide ID configuration by scanning a vial label and scanning a corresponding slide label.

**Figure 6-48 Configure slide ID - summary screen**

To test the slide ID configuration, use a labeled vial and the labeled slide that goes with it. Place the labeled vial and slide into slot 1 of the input carousel. Close the doors and press **Continue** to scan.

The instrument moves the vial in slot 1 of the carousel and scans the vial ID. The instrument removes the slide from slot 1 of the carousel and scans the slide ID. The test checks that the vial ID scanned matches the vial ID configured, that the vial ID scanned matches the slide ID scanned, and that the slide ID scanned matches the slide ID configured on the instrument.

The test of the configuration generates two pieces of information for the vial ID and two for the slide ID.

- Vial ID - The entire accession ID from the vial is shown, and the segment of that vial ID that matches the slide ID is shown as the “Formatted ID”.
- Slide ID - The entire accession ID in the slide ID is shown, and the segment of the slide ID that matches the vial ID is shown as the “Formatted ID”.
- Chain of Custody - This checks that the formatted ID segments of the vial ID and slide ID match.

# 6

## USER INTERFACE

The screen display shows the vial ID that was scanned, the slide ID that was scanned and the section of the vial ID and slide ID that match.



Successful slide ID configuration for pre-printed slides. The vial ID and the slide ID in this example have the segment “9999” in common, which can be configured as the segment starting after the eighth position and ending after 4 characters.

If the vial ID and/or slide ID do not match their configuration settings, or if the specified segment of the slide ID and vial ID do not match, a red “x” appears in the test configuration results. Correct the vial ID and/or slide ID configuration settings before processing samples.

**Figure 6-49 Test slide ID settings**

When the slide ID is properly configured, return to the summary screen and save the changes.

**LIS (Laboratory Information System)**

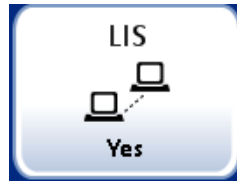

LIS button shows the current setting.

**Figure 6-50 LIS Button**

If your system is equipped with the optional LIS interface, select whether batch reports are automatically sent to the server or not. See Figure 6-51.

Select **Yes** in order to copy batch reports to the server. Select **No** if batch reports are not to be copied.

**Note:** Batch reports are stored in system memory for two months and purged as new ones are generated. If your configuration includes the optional LIS interface, reports are *also* stored indefinitely on the NAS until your system administrator purges them.

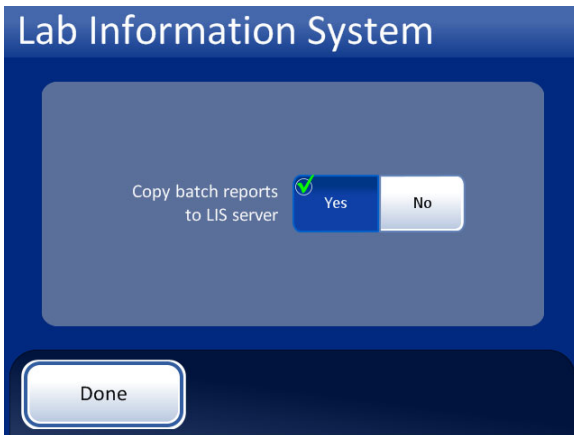

Batch reports will be copied to the NAS for access via the LIS server.

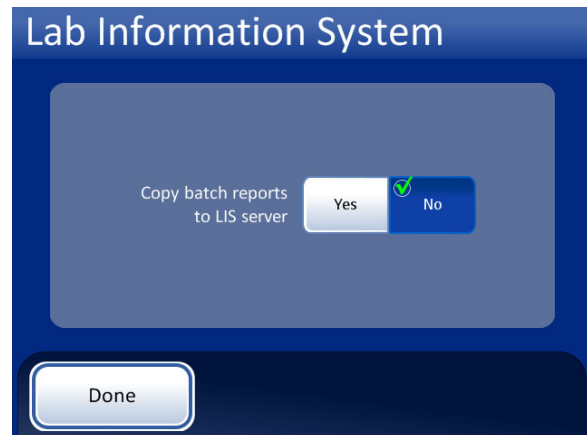

Batch reports will not be copied to the LIS server.

**Figure 6-51 LIS Yes/No**

## Reports and Logs



**Figure 6-52 Reports and Logs Button**

The Reports and Logs interface presents system information in three forms:

- **System Events** - a log of all system errors excluding UPS power status events or sample preparation errors that do not interfere with the operation of the instrument. The record of errors is retained for three years; errors older than three years are purged.
- **Batch Reports** - displays the success or failure of sample processing for each carousel processed.
- **Usage Details** - indicates the number of slides successfully created to date, by sequence type.

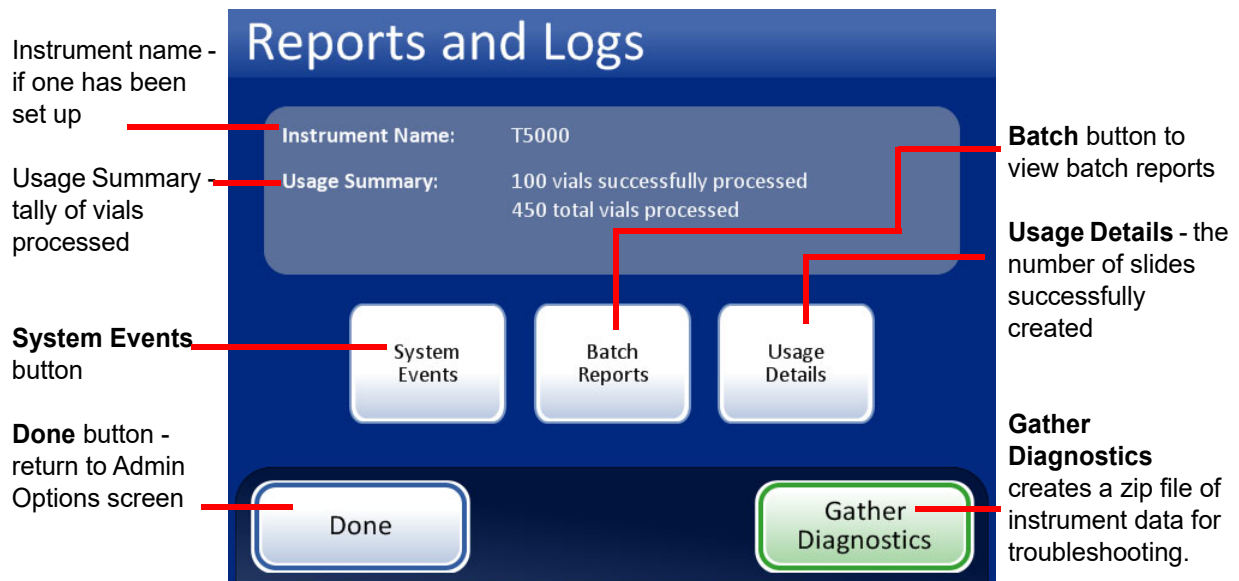

**Figure 6-53 Reports and Logs Screen**

**System events**



**Figure 6-54 System Events Button**

The System Events screen displays all of the error conditions encountered during sample processing. A system event is an error condition that the instrument is not capable of recovering from without user intervention.

**System Events** Event Codes

Instrument name: Instrument: T5000 Date: 7/16/2010

List of system events:

- Event ID
- Date/Time
- Usage Count (total of all samples run to date)

Event	Date/Time	Usage Count
6802-CM551	7/7/2010 10:48 AM	630
6802-CM551	7/7/2010 10:46 AM	630
6802-CM551	6/30/2010 3:56 PM	322

Event Codes button displays an event code list

Save to USB

Print report (if optional printer is present)

Done button - return to Reports and Logs screen

Done Save to USB Print

**Figure 6-55 System Events Screen**

The list of system events includes the event code, the date and time of the error and the usage count - a tally of all samples processed on the instrument at the time of the event.

The **Event Codes** button displays a list of error codes that have been encountered by the system. (Refer to Chapter 9, Troubleshooting for detailed explanations of error codes.) Figure 6-56 shows an error codes list.

# 6

## USER INTERFACE



**Figure 6-56 Event Codes Screen**

### Batch reports



**Figure 6-57 Batch Reports Button**

The system creates an individual batch report for each carousel processed in the system. A batch can be 1–20 samples in a carousel.

A display will show a list of the reports generated for the last eight weeks, with the most recent at the top of the list. Each individual report is titled by a date and time stamp, generated at the moment the batch completed. Scroll up and down the list using the up and down arrow buttons. Select a report by touching it. See Figure 6-58.



**Batch Reports** Refresh

Select a batch report to view details

Sample Type	Date	Time
Gyn	Tue 9/11/2018	12:00 AM
Non-Gyn	Mon 9/10/2018	5:00 AM
UroCyte	Sun 9/9/2018	9:00 PM
Gyn	Sat 9/8/2018	12:00 AM
Gyn	Fri 9/7/2018	3:00 PM

Done Save All To USB Find Vial By ID

Refresh button

List of batches, titled by date and time

Touch a report to view it.

Scroll through the list of reports.

Done button - return to Reports and Logs screen

Save All to USB button

**Figure 6-58 Batch Reports List**

Touch a report field to select it. The report is displayed on the user interface. See Figure 6-59 and Figure 6-60.

# 6

## USER INTERFACE

Batch Report Sequence: Non-Gyn Start Time: 9/6/2018 1:00 AM  
 Batch status Status: OK End Time: 9/6/2018 3:00 AM

Process summary 2 Vials Processed: 1 OK 1 Event 1 Error

Carousel Pos.	Vial ID	Slide ID	Status
3	ABCDE	ABC123	5002 ❌
2	00002	00002	OK ✅
1	12345	12345	5001 ⚠️

Done Save to USB Print

Event Codes

Press the **Event Codes** button to find a description of the error code

Sample Status:  
 OK = slide made  
 Error = sample error, no slide made  
 Event = slide made, but needs attention (sample dilute for example)

Done button to return to Reports display

**Figure 6-59 A Batch Report Display - Successful Batch**

Batch Report Sequence: Non-Gyn Start Time: 9/6/2018 1:00 AM  
 Status: ❌ 6208 End Time: 9/6/2018 3:00 AM

2 Vials Processed: 1 OK 1 Event 1 Error

Carousel Pos.	Vial ID	Slide ID	Status
3	ABCDE	ABC123	5002 ❌
2	00002	00002	OK ✅
1	12345	12345	5001 ⚠️

Done Save to USB Print

Event Codes

Status ❌ = batch stopped due to system error - the error code is shown.

Press the **Event Codes** button to find the error code number description.

**Figure 6-60 A Batch Report Display - Batch Ended Due to System Error**

**Batch report printout**

The header of every batch report identifies every batch with:

- Date/time stamp, which records the time the batch started and ended
- The names of the lab and the processor (if this is set up in the Settings tab, page 6.22)
- The serial number of the ThinPrep 5000 processor
- The type of process sequence selected for the batch to run

The batch report lists every vial encountered by the system and for each vial, lists:

- The carousel position of the vial
- The vial ID read off of the vial label
- The slide ID read off of the slide label
- Any system events that may have occurred, with the event code and description
- Any vial events that may have occurred, with the event code and description
- Vials processed



**ThinPrep® 5000 Batch Report**

**Start Time:** 10/21/2010 10:15 AM  
**End Time:** 10/21/2010 11:45 AM  
**Lab:** Hologic  
**Instrument:** T5000  
**Serial number:** D002K09DP  
**Sequence:** Gyn  
**Status:** OK

**2 Sample Errors**

Carousel Pos.	Vial ID	Slide ID	Status	Description
1	83668909999150	83668909999150	5010	Insufficient fluid or no filter present
2	79000781178110	79000781178110	5002	Failed to uncap vial

**18 Vials Processed: 16 OK 2 Events**

Carousel Pos.	Vial ID	Slide ID	Status	Description
3	83668809999025	83668809999025	OK	-
4	79000151115002	79000151115002	5000	Sample is dilute
5	08387390999138	08387390999138	OK	-
6	83805969999060	83805969999060	5000	Sample is dilute
7	10019939999083	10019939999083	OK	-
8	10019979999206	10019979999206	OK	-
9	83668729999235	83668729999235	OK	-
		74007569999002	OK	-
		79000151135022	OK	-

**Figure 6-61 Batch Report Example**

To print a report, press the **Print** button (if your processor is configured with a printer).

To save a report as a text file, press the **Save to USB** button. See the next section.

To close a report, press the **Done** button.

**Note:** The system will retain batch reports for eight weeks and then purge them from the database. Should your lab require longer record retention, plan to print or download the batch reports.

**Save a report to USB key**

Refer to Figure 2-4 for USB port locations.

Reports can be saved to a USB key (also known as a thumb drive, flash drive, keychain drive). Insert a key into any of the USB ports.

**CAUTION:** Always use the USB drive provided with the processor. Never use a U3 Smart Drive. While the system is able to write to this device, there is a significant problem if the system is booted with one of these drives inserted in a port. Field service would be required. Note also that the system cannot write data to a write-protected USB key.

When the **Save to USB** button is pressed, the report that is open on the user interface is immediately saved to the USB device as an XML file. A confirmation message displays on the interface. See Figure 6-62.

**Note:** If the system detects that more than one USB port has a USB key inserted, a message via the user interface will prompt you to select which port to send the report to.

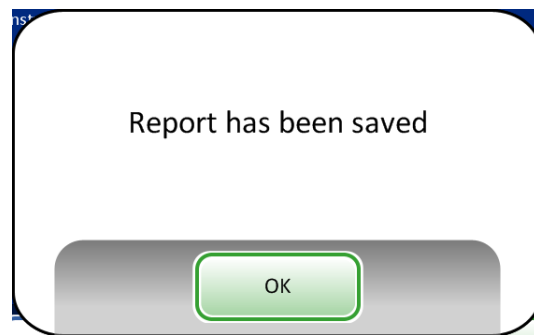

**Figure 6-62 The Report Has Been Saved Message**

The system creates a folder titled T5000Reports on the USB device. Each report is written to there. Reports are automatically named by the convention of “Report type - Processor Name - Date and Time. XML.” This is illustrated below. With each report type, a style sheet file is also created, so that when the report is viewed or printed from any other source, it will look like the report seen on the T5000 interface.

# 6

## USER INTERFACE



**Figure 6-63 Reports Saved to USB**

**Usage details**



**Figure 6-64 Usage Details Button**

 A screenshot of the "Usage Details" screen. The title "Usage Details" is at the top left. Below it, "Instrument: T5000" and "Date: 7/16/2010" are displayed. A table shows sequence types and their counts. At the bottom are three buttons: "Done", "Save to USB", and "Print". Red lines connect labels to specific elements on the screen.
 

Sequence	Success	Total
Gyn	3990	4000
Non-Gyn	158	160
UroCyte	80	80
<b>Total</b>	<b>4228</b>	<b>4240</b>

**Figure 6-65 Usage Details Screen**

The usage details report keeps a tally of the number of slides created to date on the ThinPrep 5000 processor.

The usage history report header identifies:

- The date and time of the report
- The lab name (if one is used)
- The processor name (if one is used)

The usage history report identifies:

The number of slides successfully processed, Gyn (includes Imager slides), Non-Gyn and UroCyte.

# 6

## USER INTERFACE

**Note:** A sample vial that is picked up, uncapped and placed into the dispersion well increments the Total samples run counter. A slide deposited into the fixative bath increments the Successful samples run counter.

For Multiple Slides per Vial mode, a slide picked by the slide gripper increments the Total samples run counter. A slide deposited into the fixative bath increments the Successful samples run counter.

### Gather Diagnostics



**Figure 6-66 Gather Diagnostics Button**

Gather Diagnostics is a function intended for instrument troubleshooting by Hologic Technical Support. It gathers and zips the error history log and other instrument operating information. It is not accessible to operators.

Put a USB device into one of the USB ports and press the **Gather Diagnostics** button.

Select the **Full** or **Quick** option, based on the instructions from Hologic Technical Support.



**Figure 6-67 Select the Option for Gathering Diagnostic Data**





**Figure 6-68 Gather Diagnostics Screen**

The instrument operating information will be gathered into a folder on the USB device titled T5000Logs. There will be three zipped files in the folder. These can be e-mailed to Hologic Technical Support.

### **Clean System**

This is described in Chapter 8, Maintenance.

### **Clean Screen**

This is described in Chapter 8, Maintenance.

### **Empty Liquid Waste**

This is described in Chapter 8, Maintenance.



## USER INTERFACE

This page intentionally left blank.



# Chapter Seven

## Operating Instructions

### SECTION A

### INTRODUCTION

Normal instrument operation consists of loading supplies, starting the batch and unloading the prepared slides and processed sample vials when the batch is complete. A batch report is generated at the completion of each batch. The report indicates the success or failure of processing each vial, as well as any errors encountered. The report may be viewed on the user interface or a hard copy may be printed out, or the report may be saved as a text file to a USB key.

### SECTION B

### MATERIAL REQUIREMENTS

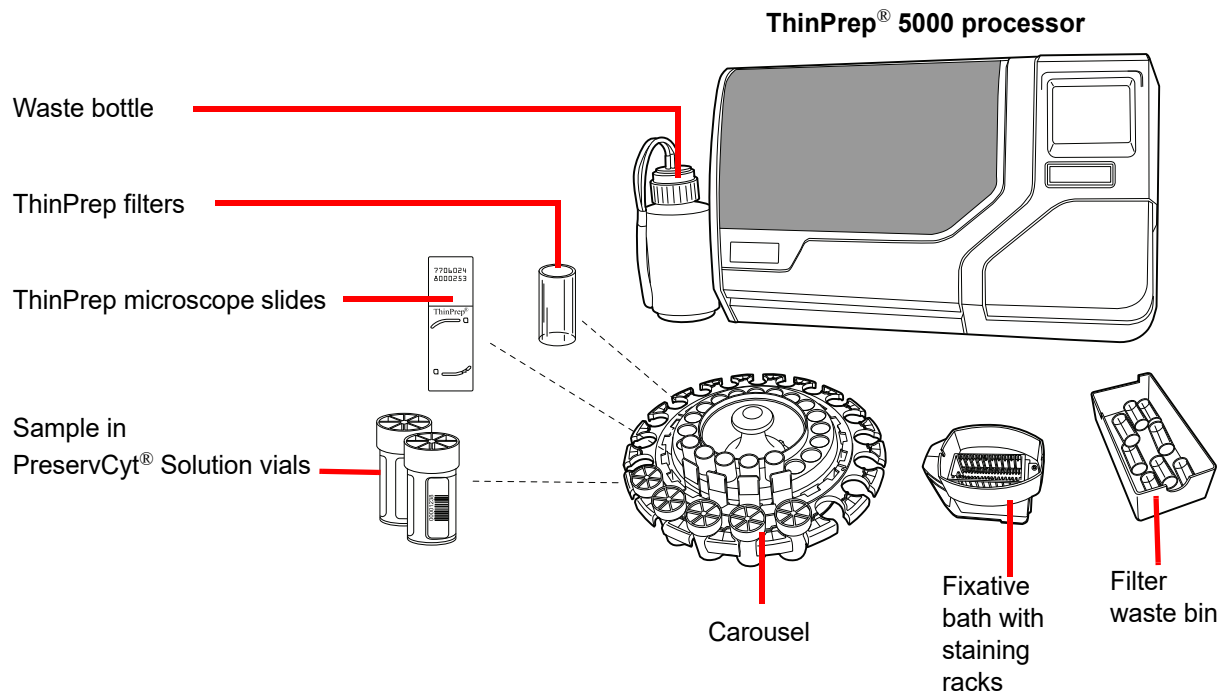

Figure 7-1 Required Materials



## OPERATING INSTRUCTIONS

ThinPrep® **PreservCyt Solution** vial is a plastic vial that contains a methanol-based preservative solution that preserves cells from all body sites. PreservCyt Solution is used for transportation, storage and processing of cellular sample.

- Store PreservCyt Solution with gynecologic sample intended for ThinPrep Pap testing between 15°C (59°F) and 30°C (86°F) for up to 6 weeks.
- Store PreservCyt Solution with non-gynecologic samples intended for cytology between 4°C (39°F) and 37°C (98°F) for up to 3 weeks.

Refer to Chapter 3 for detailed information on PreservCyt Solution.

The **ThinPrep filter** is a disposable plastic cylinder that is open at one end and has a filter membrane bonded onto the other end. The filter membrane has a flat, smooth, porous surface. The pore size differs, depending on the process application, thus there are three filter types for use on the ThinPrep 5000 processor:

- ThinPrep Pap test filters (clear)
- ThinPrep Non-gynecologic filters (blue)
- ThinPrep UroCyt filters (yellow)

The **ThinPrep microscope slide** is a high-quality, pre-cleaned, glass microscope slide with a defined screening area and a large labeling area. The slide is designed specifically for use with the ThinPrep 5000 processor and depending on the process application there are three types of slides:

- ThinPrep microscope slides for use with ThinPrep processors are for gynecologic or non-gynecologic sample processing.
- ThinPrep Imaging System microscope slides for gynecologic slides that will be subsequently imaged on the ThinPrep Imaging System. (They bear pre-printed fiducial marks required for the Imaging System.)
- ThinPrep UroCyt microscope slides for use with the ThinPrep UroCyt urine sample processing. (The slides bear a particularly defined cell spot area for the processing of urine specimens.)

The **carousel** is a plastic tray that holds up to twenty sets of vials, filters and slides.

The **alcohol fixative bath** is a plastic tub that is filled with standard laboratory fixative alcohol (95% reagent alcohol or 95% ethyl alcohol). The bath holds a staining rack, into which the processed slides are automatically deposited.

The **staining rack** is a standard staining rack used for collection and staining of cytologic slides.

The **ThinPrep 5000 Processor Operator's Manual** contains detailed information about the operation, troubleshooting and maintenance of the processor. It also contains information on the solutions and materials required to prepare slides with the ThinPrep 5000 processor.

**Disposable laboratory gloves** — Wear protective clothing in accordance with universal precautions when operating the instrument.

**SECTION  
C****LABELING THE SAMPLE VIALS AND SLIDES**

The ThinPrep 5000 processor scans and matches the sample vial labels with the corresponding slide labels. The slide scanner can read either barcode or OCR formatted labels. (See “Configure Barcodes” on page 6.28 and “Configure Slide ID” on page 6.34 for setting which format the scanner reads.)

**Vial Barcode Label Format**

The sample vial barcode label must meet ANSI X3.182 specifications with a quality of grade B or better. Hologic recommends Code 128, 1-D barcode symbology for the barcode label on the sample vial.

The ThinPrep 5000 processor also supports Interleaved 2 of 5, Code 39, Code 93, Codabar (NW7) and EAN-13/JAN 1-D barcode symbologies.

No OCR vial label formats may be used. With an optional upgrade, the ThinPrep 5000 processor supports DataMatrix and QR Code 2-D barcode symbologies on labels on vials.

Refer to “: Slide Restrictions Based on Vial Barcode Symbology Used” on page 6.34 for detailed description of constraints placed on the ID depending on the slide format used.

For vial labels with a 2-D Data Matrix ECC 200 symbology, the minimum module width is 15 mil. The barcode should have a quiet zone around all four sides of at least one module width. The ThinPrep 5000 processor supports a vial ID of 5 to 64 characters. All printable ASCII 128 characters are supported.

Some ThinPrep vials come from Hologic with 2-D barcodes printed on the vial label. The ThinPrep 5000 processor recognizes that these are not barcodes for vial IDs.

There are two 16-digit numbering schemes that the ThinPrep 5000 processor will not recognize as a vial ID. If your laboratory uses a 16-digit vial ID format, do not use a vial ID in the format 10XXXXXX17XXXXXX, nor the format 01154200455XXXXX.

Use a square 2-D barcode that prints no larger than 9.53 mm (0.375 in.) x 9.53 mm (0.375 in.). This barcode must be printed clearly, not blurry or smudged.

**Adhering Vial Labels**

Place a vial label with a 1-D barcode vertically on the PreservCyt® Solution label, using the edge for alignment, as shown in Figure 7-2. A crooked label, skewed 10 degrees or more from vertical, may not scan properly.

Place a vial label with a 2-D barcode in the lower third of the vial, between 20 mm (0.80 in.) and 5 mm (0.20 in.) from the bottom of the vial, close to but not covering the frosted area of the vial. For the ThinPrep 5000 processor to properly read the 2-D barcode, do not put any other 2-D barcode label on the vial.



## OPERATING INSTRUCTIONS

During application, avoid placing the barcode label over patient information, multiple labels, or on the torque features of the vial. Do not place labels on the vial cap or on the bottom of the vial. Sticking labels on incorrectly can cause a failure to read the barcode or a failure of the instrument removing the vial from the carousel.

The uncovered strip of the sample vial allows you to see the frosted band which indicates the maximum/minimum acceptable fluid fill range for a sample to be run on the processor. Make sure the fluid level is within this range.

Additionally, check to make sure there is no foreign matter in the vial (such as a piece of sample collection device or other non-biologic debris).

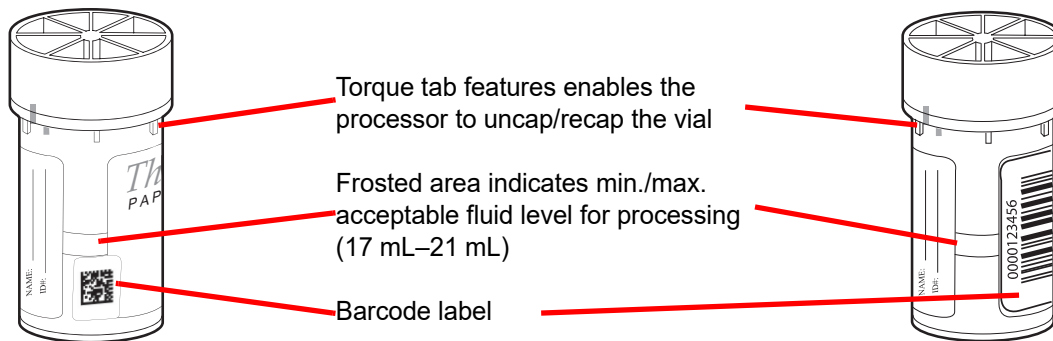

**Figure 7-2 PreservCyt Solution Sample Vial**

### Slide Labeling Requirements

Slides must bear a label with an accession ID that matches the ID on the vial. (Refer to “Advanced processing options” on page 6.5 for disabling slide ID match temporarily.)

### Slide barcode label format

Slide barcode labels may be 1- or 2-dimensional. See Table 6.2 on page 6.34 for any restrictions required. Slide labels may be printed and applied or directly printed or etched onto the slide, but make sure the contrast is sufficient for the scanner to read the label.



**Figure 7-3 Examples of How Barcodes Fit onto a ThinPrep Slide**

The barcode must have a minimum height of 0.22 inch (5.88 mm) and a maximum width no wider than 0.75 inch (19.05 mm).

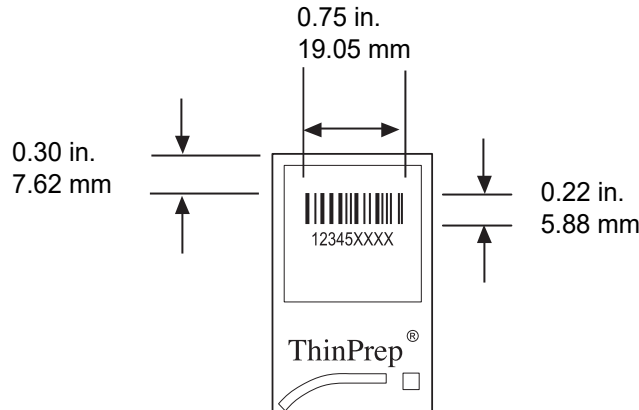

**Figure 7-4 Barcode Slide Label Format**

**Slide OCR label format**

OCR label format must be 14 characters long (which reserves the last 3 characters as check characters). See Figure 7-6.

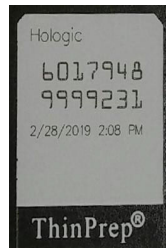

**Figure 7-5 Example of a Laser-printed OCR Label on a ThinPrep Slide**

**Required slide label format for use with the ThinPrep® Imaging System**

For ThinPrep Pap test slides that will subsequently be imaged by the ThinPrep Imaging System Imaging Station, slide labels must be in an OCR, 14 character, 7 digits-over-7 digits format, with the last 3 digits being a CRC number. The font must be 12 point OCR-A. Numbers only, no alpha characters.





## OPERATING INSTRUCTIONS

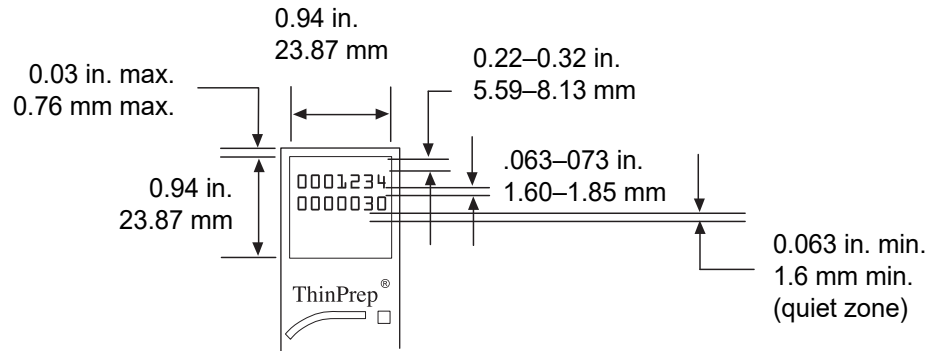

**Figure 7-6 Slide OCR Label Formats**

Slide labels that are applied to the microscope slide must be compatible with staining and coverslipping processes and be xylene-resistant. When adhering the labels, be sure to apply them smoothly to the frosted area of the slide, with no overhang or air bubbles. Labels should be centered side to side. The OCR or barcode IDs must be in an area that the scanner is able to read, as seen in Figure 7-6.

**SECTION  
D**

**LOAD THE THINPREP 5000 PROCESSOR**





**CAUTION:** Prior to loading and operating the ThinPrep 5000 processor, please note that if ancillary testing is to be performed, read and understand the instructions in “OPTIONAL INSTRUCTIONS FOR ANCILLARY TESTING” on page 7.19.

**Load Vials, Filters and Slides into the Carousel**

**CAUTION:** For best slide preparation results, use the correct slide and vial type for the sample type that is processed.

Load the correct filter type and slide type for each vial. (Refer to Table 7.1.) The batch can hold up to twenty samples. If the batch is not fully loaded, the samples do not have to be contiguous within the carousel.

**Table 7.1: Sample/Filter/Slide Configurations**

	ThinPrep		ThinPrep + Imaging	UroCyte
PreservCyt sample	Gynecologic	Non-gynecologic	Gynecologic	Urine for use with Vysis UroVysion molecular testing
Filter	Clear	Blue	Clear	Yellow
Slide	Cell spot arc	Cell spot arc or arc-less	Cell spot arc with fiducial marks	Cell spot circle
				

Load the labeled vials into the carousel. Load the corresponding slide into the slot behind the vial. Load the slide so that the front side (cell spot side) faces outward. **Only handle slides by the edges - never touch the surface within the cell spot area.**

Load the filter into the position behind the vial and slide. Load the filter by grasping the sides of the cylinder. Place it into the position with the membrane end down and the open end up. **Never touch the filter membrane or the inside of the cylinder.**

# 7

## OPERATING INSTRUCTIONS

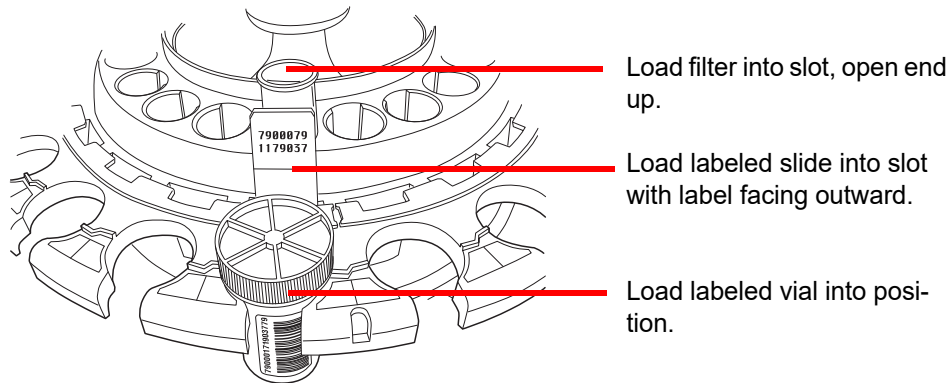

**Figure 7-7 Load Carousel with Vials, Slides and Filters**

**Note:** The filters, slides and vials can be loaded in any order that is convenient for loading (filters then slides then vials), as long as the patient ID labels match up.

A dust cover is available for the carousel, meant to keep the filters and slides clean until they are ready to be processed. It is possible to prepare several carousels in advance and stack them with a dust cover on the topmost carousel. Be sure to remove the dust cover prior to loading the carousel into the instrument.

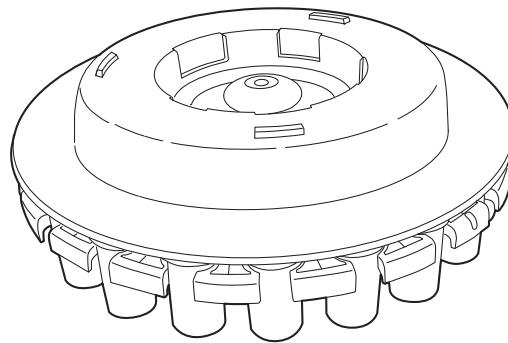
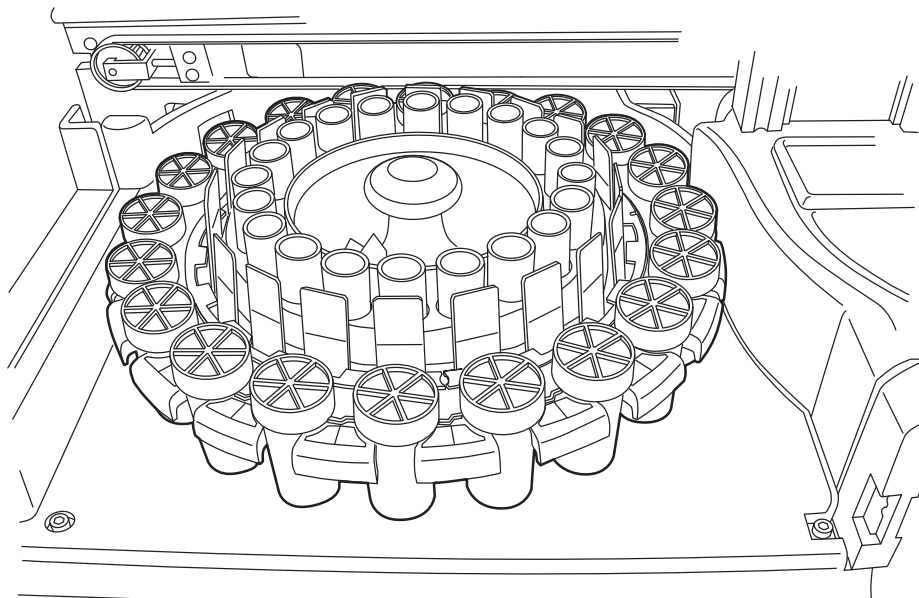

**Figure 7-8 Carousel Dust Cover**

### Load the Carousel into the Processor

Load the carousel into the processor. Open the front door and slide the tray into the center of the processing area. It is properly in place when it stops against the rear wall.

The carousel does not have to be inserted with the number 1 position oriented in a particular way. When the instrument begins processing, it will automatically align the carousel to begin processing at position 1.



**Figure 7-9 Load Carousel into the Processor**

### **Load Alcohol Fixative Bath into the Bath Compartment**

When filling the fixative bath tubs, place an empty staining rack into the fixative bath receptacle.

Orient the rack so that the embossed words on the side that read "UP SIDE" face the handle of the bath. See Figure 7-10. It can be felt to snap into place. It is important that the bath is fully seated.

Fill the tub with alcohol until the top of the staining rack is just submerged, but not so full that the addition of slides will cause the bath to overflow.

If the fixative baths are left on the instrument, this fill level will be sufficiently full to prevent exposure of the cell spot due to evaporation for a period of up to 72 hours.

**Note:** If there is a delay between removing the fixative baths from the instrument and staining and coverslipping the slides, be aware that evaporation of the alcohol is a consideration.

“UP SIDE” faces bath handle

Fill bath with alcohol up to here

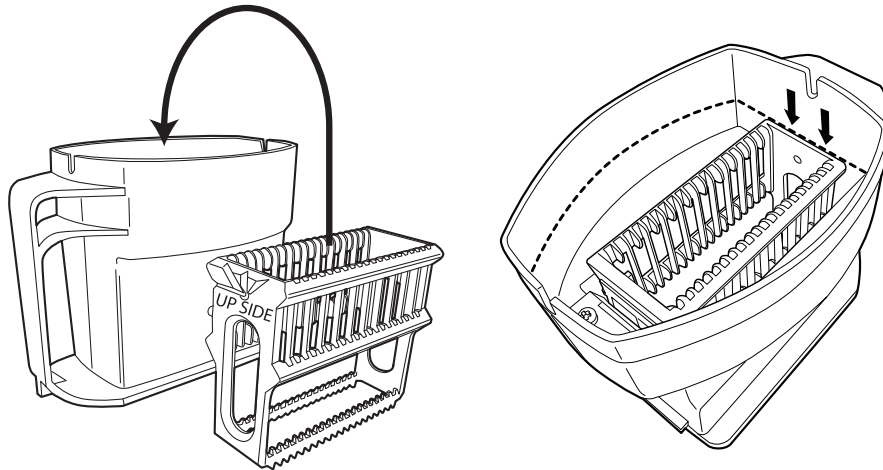

**Figure 7-10 Fixative Bath and Staining Rack**

Open the door to the bath compartment and slide the bath container into the slot until it stops.

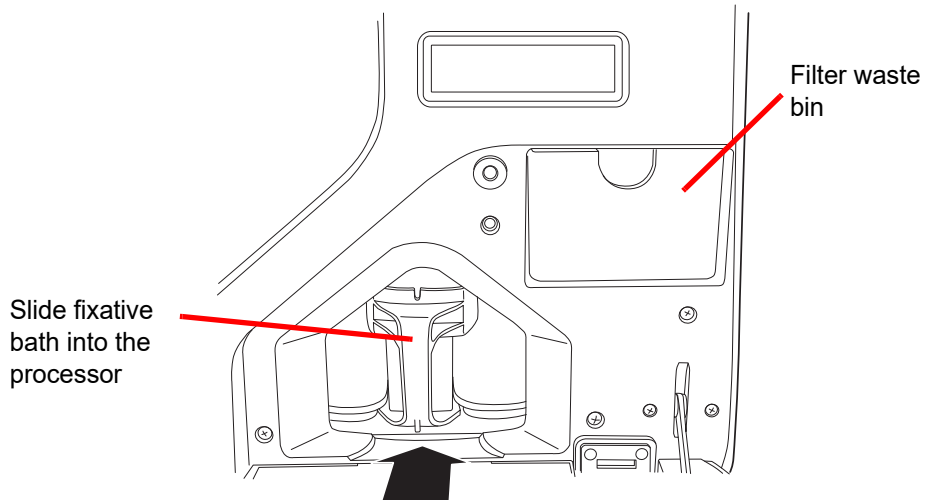

**Figure 7-11 Load Fixative Bath into the Processor**

### Empty Filter Waste Bin

Pull out the filter waste bin and empty it of any used filters that may be present and return the bin to its compartment. The filters may be disposed of as regular waste. See Figure 7-10.

**Note:** The capacity of the waste filter bin is 20 filters. Empty the waste bin prior to running a batch. Close all doors.

SECTION  
E

## SELECT THE SAMPLE PROCESSING SEQUENCE

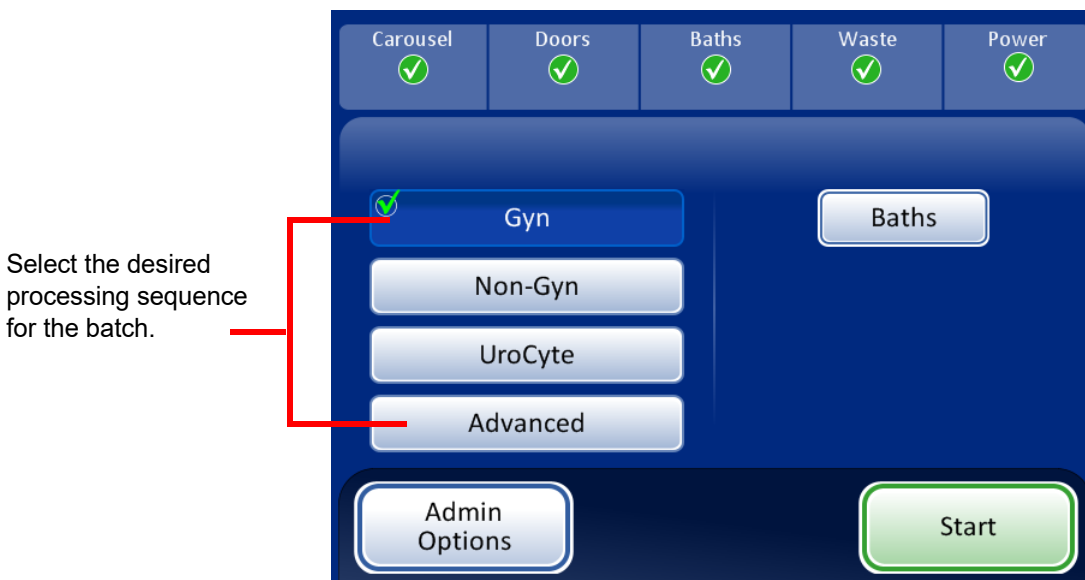

**Figure 7-12 Sample Processing Sequence**

**Gyn** for running a batch of gynecologic samples

**Non-Gyn** for running a batch of non-gynecologic samples

**UroCyte** for use with urine in the Vysis® UroVysion assay

**Advanced** enables selection of:

**Disable Slide ID Match**, which allows one sample to be run with the vial/slide ID match turned off. One vial of any sample type may be processed: gynecologic, non-gynecologic or UroCyte. Refer to “Disable slide ID match” on page 6.5. A “Chain of custody is off” message displays on the screen during processing.

**Multiple Slides per Vial**, which processes a non-gynecologic specimen and extracts from 1 to 10 samples from the same vial. The system will bypass the fluid level too low check when processing multiple samples per vial. Refer to “Multiple slides per vial” on page 6.7.

# 7

## OPERATING INSTRUCTIONS

### SECTION F

### INITIATE A BATCH

When the input carousel has been loaded with labeled sample vials, the appropriate filters and slides, and a fixative bath is ready in the bath compartment, select the sample processing sequence and press the **Start** button (Figure 7-13).



**Figure 7-13 Start Batch Button**

The main door and bath door will be heard to lock. The processor goes through a pre-check and scans for the presence of vials in the carousel. It counts the number of vials, which is displayed on the progress bar.

The batch processing screen displays. See Figure 7-14.

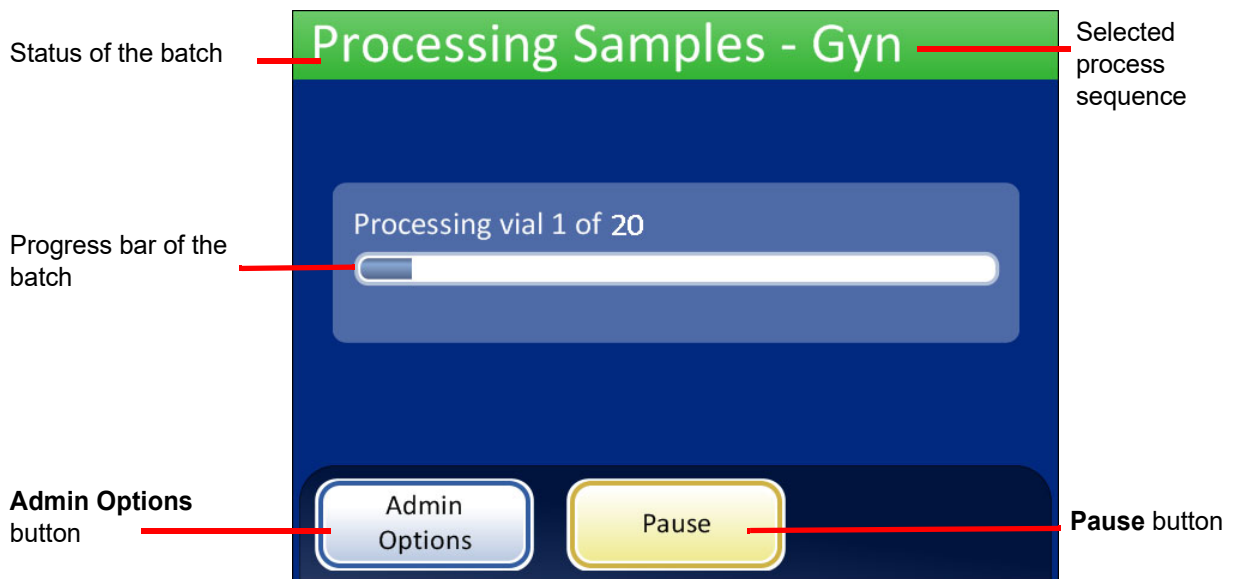

**Figure 7-14 Starting the Batch Screen**

During processing, a progress bar indicates how much of the batch has been completed. It increments during the processing of each vial, as well as to indicate overall batch progress.

If a sample error occurs, the batch continues, but an error indicator is displayed on the batch screen, as shown in Figure 7-15.

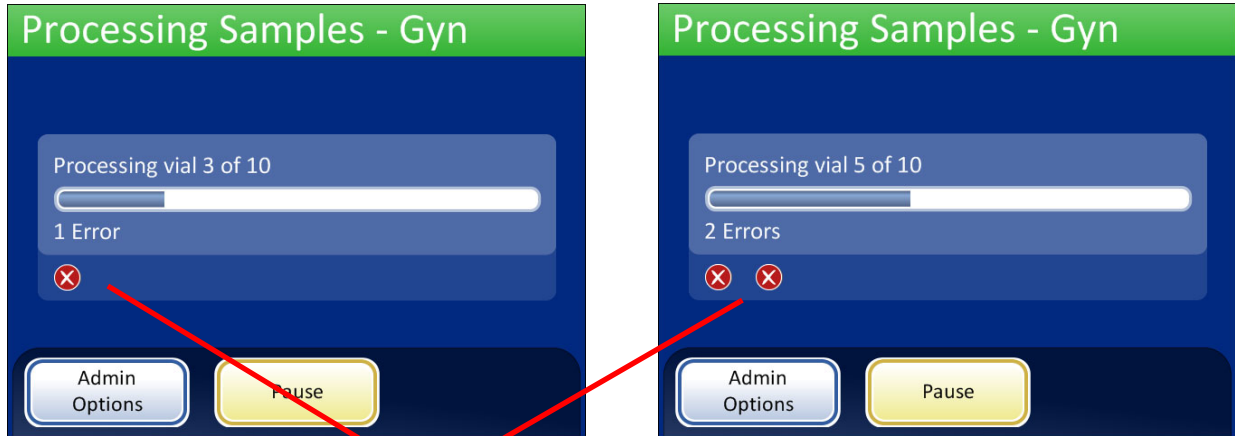

Sample error indicators are displayed on the screen during processing.

**Figure 7-15 Sample Errors During Sample Processing**

**SECTION G PROCESSING SLIDES**

The sequence of events that occurs when a batch is initiated goes in this order:

**Table 7.2: Sequence of Events in Processing a Slide**

	<p><b>Start</b> button is pressed.</p>
	<p>Spin the carousel and count vials.</p> <p><b>Note:</b> If the filter waste bin has not been emptied from the previous run, the Filter Waste Bin Full message will be displayed.</p>



# 7

## OPERATING INSTRUCTIONS

**Table 7.2: Sequence of Events in Processing a Slide**

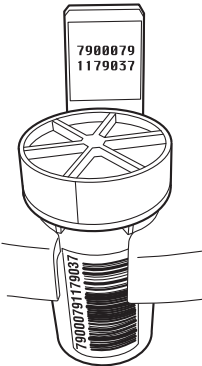
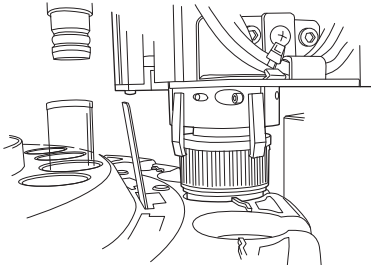
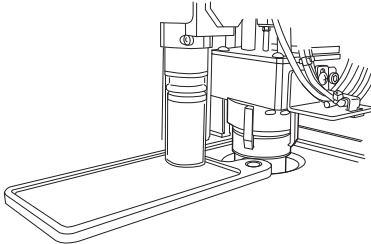
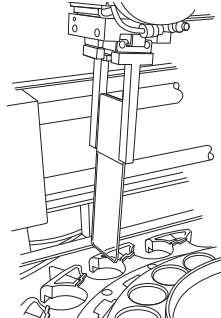
	<p>Check vial and slide IDs. Position carousel for first vial pickup.</p>
	<p>Pick up vial and then filter, and move to dispersion area.</p>
	<p>Place vial into dispersion well and tighten its cap.</p>
	<p>Pick the slide.</p>

**Table 7.2: Sequence of Events in Processing a Slide**

	<p>Spin the vial to disperse the contents.</p>
	<p>Uncap the vial.</p> <p>Introduce filter to vial and perform level sensing to verify min./max. liquid level.</p> <p>Cell collection onto filter</p>
	<p>Rotate slide to horizontal position and place on cell transfer station</p>
	<p>Cell transfer onto slide</p>



## OPERATING INSTRUCTIONS

**Table 7.2: Sequence of Events in Processing a Slide**

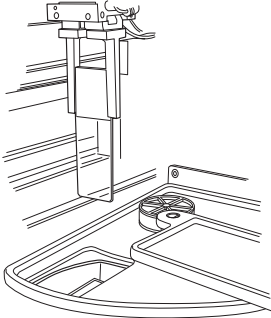
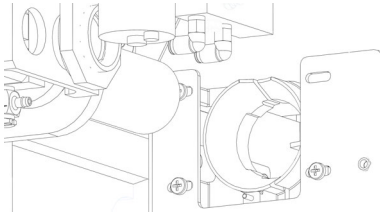
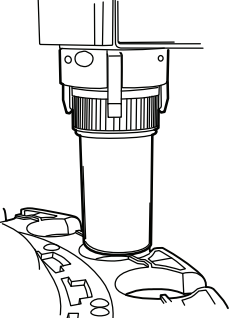
	Deposit slide into fixative bath.
	Puncture and dispose of filter.
	Recap vial. Return vial to carousel.

**SECTION  
H**

### PAUSE A BATCH

A batch may be paused by pressing the **Pause** button.

When the **Pause** button is pressed the system will complete processing the current vial and then pause.

The batch status line will report “Interrupting” as the processor puts items away and parks the mechanisms. Refer to “Pause a Batch” on page 6.10 for complete instruction on interrupting and resuming a batch.

SECTION  
I

## PROCESSING COMPLETE

When a batch has completed processing, the processor returns to an idle state, with a Processing Complete message on the screen. See Figure 7-16. The doors unlock. If an alarm sound has been set for batch completion, it will sound briefly.

Press the **OK** button to acknowledge the message and view the Processing Complete screen.

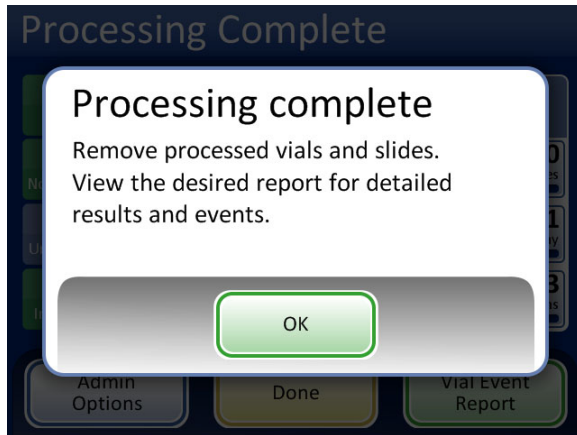

Processing Complete message



**Batch Report** button displays the report.

**Done** button returns to main screen, idle.

**Figure 7-16 Processing Complete Screen**

To view the batch report, press the **Batch Report** button. The report will display, and there is the opportunity to print the report or save it to USB key via that screen. (That can also be done at a later time, using the Reports function in Admin Options.) When the report screen is exited (by pressing the Done button), you return to the Processing Complete screen.

The screen will remain until the operator acknowledges by pressing the **Done** button.



## Batch Report

Carousel Pos.	Vial ID	Slide ID	Status
3	ABCDE	ABC123	5002 ❌
2	00002	00002	OK ✅
1	12345	12345	5001 ⚠️

Batch report, status OK

Carousel Pos.	Vial ID	Slide ID	Status
3	ABCDE	ABC123	5002 ❌
2	00002	00002	OK ✅
1	12345	12345	5001 ⚠️

Batch report, batch ended due to error

Figure 7-17 Examples of Batch Reports

Refer to “Batch reports” on page 6.44 for complete details of viewing, printing and saving batch reports.

### SECTION J

## UNLOAD THE THINPREP 5000 PROCESSOR

### Carousel

Remove the carousel from the processor. The slides that were loaded should now be in the fixative bath, and the filters should be disposed of in the filter waste bin. The sample vials have been returned to the carousel tray after processing. If slides and filters remain in the carousel, carefully match them against any slide or vial event in the batch report and reconcile the identity and disposition of the unprocessed sample.

### Remove Fixative Bath

Carefully remove the fixative bath containing processed slides. If it will not be stained and cover-slipped right away, put the evaporative cover on the bath container.

**SECTION  
K****OPTIONAL INSTRUCTIONS FOR ANCILLARY TESTING**

Testing for certain sexually transmitted diseases (STD) and for Human Papilloma Virus (HPV) in conjunction with cytology may be enabled by the removal of an aliquot of up to 4 mL (Aliquot Removal) from the PreservCyt® sample vial before preparing the ThinPrep Pap test slide.

Laboratory personnel must follow the specific instructions in this section to appropriately remove the desired aliquot volume and prepare the PreservCyt sample vial for the ThinPrep® Pap test. Adherence to these instructions must be maintained to ensure there is no adverse effect on the ThinPrep Pap test result.

Because cytology/HPV testing and STD testing address different clinical questions, Aliquot Removal may not be suitable for all clinical situations. Physicians and other persons responsible for ordering clinical tests should be familiar with the following:

- There is no evidence of degradation of cytology results by Aliquot Removal, however, this cannot be ruled out for all specimens. As with any subsampling step in anatomic pathology, chance misallocation of diagnostic cells may occur but they are very rare. If negative results from the specimen do not fit with the clinical impression, a new specimen may be necessary.
- Aliquot Removal from low-cellularity specimens may leave insufficient material in the PreservCyt sample vial for preparation of a satisfactory ThinPrep Pap test slide.
- Aliquot Removal may leave insufficient material in the PreservCyt sample vial for performance of ancillary testing (e.g., reflexive HPV testing) using the residual specimen following preparation of a ThinPrep Pap test slide.
- Co-collection of separate samples for the ThinPrep Pap test and STD testing may be considered in lieu of Aliquot Removal.
- When opting for concurrent cytologic and STD testing, providers should consider risk and clinical history (e.g., disease prevalence, patient age, sexual history or pregnancy) as well as specimen suitability (e.g., exudates or bleeding) that can impact diagnostic reliability.

Sexually Transmitted Diseases Treatment Guidelines 2002 (Centers for Disease Control and Prevention, MMWR 2002: 51(No. RR-6)) provides clinical guidance for the management and treatment of individual patients, including use of Pap testing.

**It is contraindicated to perform *Chlamydia trachomatis* and *Neisseria gonorrhoeae* testing, using the Roche Diagnostics COBAS AMPLICOR CT/NG Test, if the sample has already been processed using the ThinPrep 5000 processor.**



## OPERATING INSTRUCTIONS

### **Removing an Aliquot (of up to 4 mL) from the PreservCyt Sample Vial prior to Performing the ThinPrep Pap Test**

**Note:** Only one aliquot may be removed from the PreservCyt sample vial prior to performing the ThinPrep Pap test, regardless of the volume of the aliquot (maximum aliquot volume = 4 mL).

**Note:** Good laboratory practices should be followed to avoid introducing contaminants into either the PreservCyt® sample vial or the aliquot. It is recommended to use powder-free gloves and an individually wrapped, disposable pipetting device with an aerosol barrier tip that is sized appropriately for the volume being withdrawn and dispensed. You should not use serological pipettes. In order to minimize the potential for cross contamination, aliquot removal should be performed in an appropriate location outside an area where amplification is performed.

1. Vortex the vial at high speed for 8 to 12 seconds.

**CAUTION:** The desired aliquot must be removed immediately after vortexing the vial to ensure homogeneity of the sample.

2. Carefully remove the vial cap.

3. Using a pipetting device, withdraw an aliquot of up to 4 mL from the vial. Take care to avoid contaminating gloves with solution. If gloves should become contaminated, replace with a clean pair before proceeding to the next specimen.

4. Dispense the aliquot into a suitably sized and labeled polypropylene tube and close tightly to prevent leakage/evaporation.

5. Store the aliquot under conditions appropriate for ancillary test(s). Refer to manufacturer or laboratory instructions for performing ancillary test(s) on the aliquot.

6. Dispose of the pipetting device in accordance with local, state, and federal regulations.

7. Using a new pipetting device, withdraw a quantity of unused PreservCyt Solution from its container that is equal in volume to that of the aliquot removed from the vial in step 3.

8. Transfer the volume of unused PreservCyt Solution to the vial from which the aliquot was removed in step 3.

9. Secure the vial cap. (The line on the cap and line on the vial should meet or slightly overlap.)

10. Dispose of the pipetting device in accordance with local, state, and federal regulations.

11. Refer to the sections in this chapter to complete the ThinPrep® Pap test.





# Chapter Eight

---

## Maintenance

**Table 8.1: Routine Maintenance**

Every Batch	Empty filter waste bin at the start of each batch.
Daily or more	Change fixative every 100 slides or daily, whichever comes first.
Weekly	Clean around the carousel, dispersion area and filter puncture/disposal area.
	Clean slide holder pneumatic suction cups.
As needed	Empty waste bottle.
	Clean the touch screen.
	Clean input carousel and dust cover.
	Change absorbent pads.
	Remove and clean drip trays.

**SECTION  
A**

**DAILY**

### Change Fixative Reagent

The fixative alcohol in any bath should be changed out every 100 slides, or daily, whichever comes first. Consider how your laboratory uses baths in the count to 100. For example, one bath used with 20 slides for 5 batches needs the fixative alcohol changed before the next batch is run (or daily).

- Dispose of fix reagents according to your laboratory’s protocols.
- Clean the fixative bath containers, covers and staining racks according to your laboratory’s protocols.



## MAINTENANCE

### SECTION B

## WEEKLY CLEANING

### Clean System



Use the **Clean System** button in several weekly maintenance activities. The **Clean System** button moves the mechanical arms in the processing area to positions that make them easier to reach for routine maintenance.

1. Touch the **Clean System** button and the display screen guides the operator through the process.
2. Close the doors and press **Continue**. Keep the doors closed while the instrument is moving parts.
3. When the screen display says, "Follow instructions in manual for cleaning," open the door(s) and perform the routine maintenance cleaning tasks. Refer to "Clean Around Carousel And Dispersion Areas" on page 8.4 and "Clean Slide Holder Pneumatic Cups" on page 8.5.
4. In this state, the vial/filter transport arm and the slide transport arm can each move freely along their tracks. Gently slide the arms to positions convenient for cleaning the various parts of the instrument.

The mechanisms in the filter waste area move toward the processing area to make them easy to reach for cleaning.

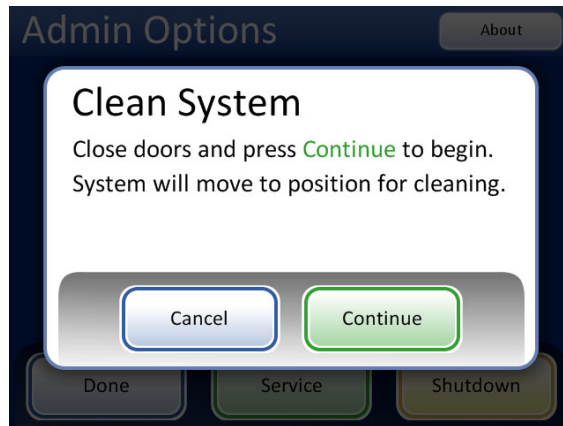

The Clean System feature allows the slide transport arm and the vial/filter transport arm to slide freely for access during maintenance

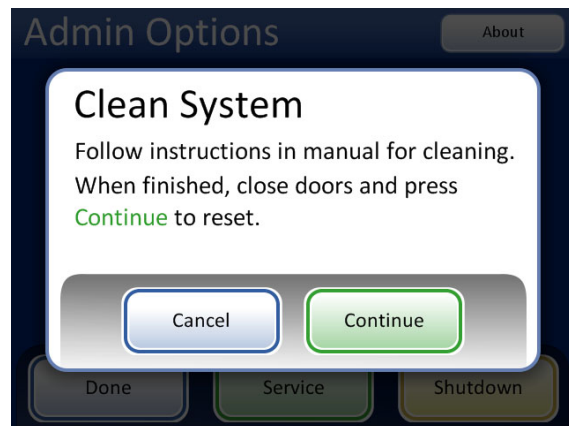
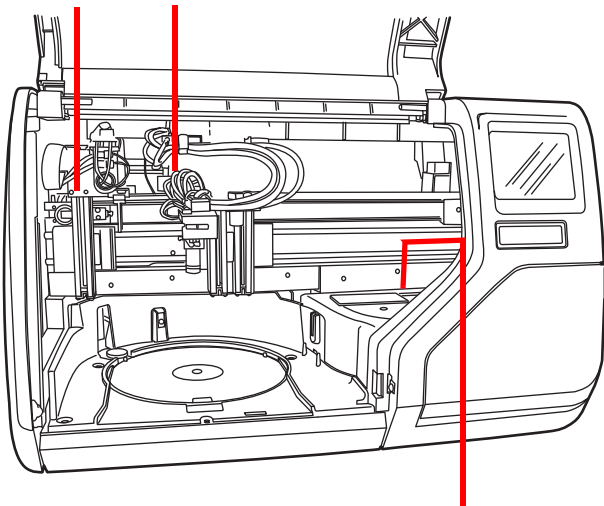

The mechanisms in the filter waste area move towards the processing area.

**Figure 8-1 Clean System**

5. When you are finished cleaning, close the doors and touch the **Continue** button. The instrument resets the mechanisms.
6. Press **Done** to return to the Admin Options screen.

### Clean Around Carousel And Dispersion Areas

On a weekly basis, remove the carousel and clean around the bottom of the processing area, using deionized water and lint-free towels. Do not dislodge the carousel sensors, but do keep the area around them clean and make sure nothing blocks them. See Figure 8-2.

Use the Clean System feature to help move instrument mechanisms out of the way. See “Clean System” on page 8.2.

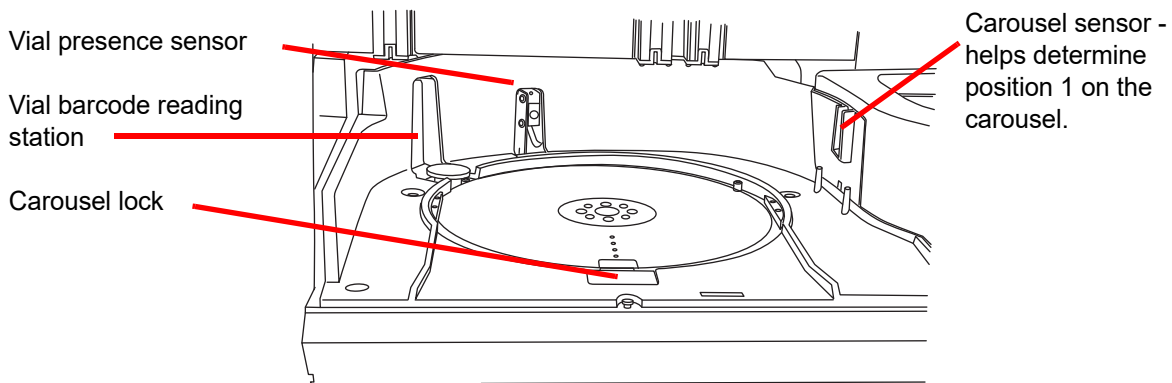

**Figure 8-2 Carousel Sensors**

Clean around the dispersion well and the evaporative cover over the fixative bath.

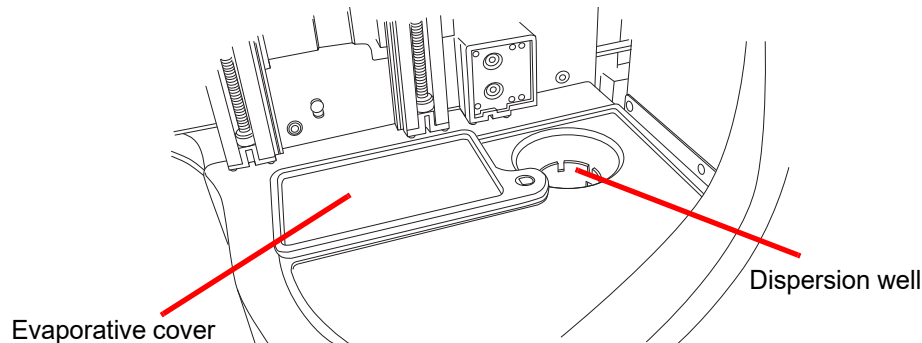

**Figure 8-3 Clean Dispersion Well Area**

If there is buildup of residue from PreservCyt Solution on the filter plug, around the filter puncture point area and other surfaces surrounding the filter waste area, use a cloth or swab soaked with 70% alcohol to dissolve any crust and clean away precipitate. See Figure 8-4.

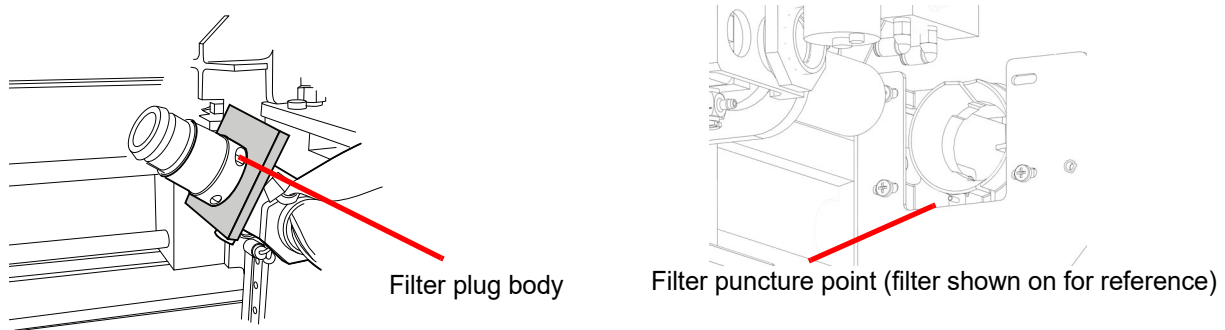
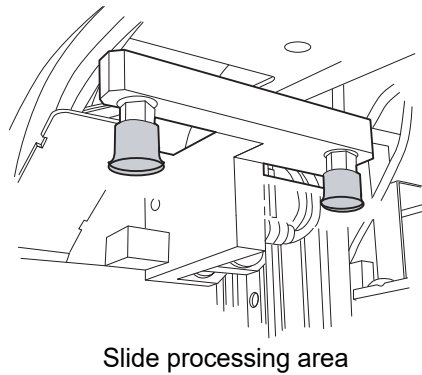

**Figure 8-4 Clean Filter Plug and Filter Puncture Area**

**Clean Slide Holder Pneumatic Cups**

A lint-free cloth soaked with de-ionized water may be used to wipe down the surfaces of the slide holder cups. Be sure to let the suction cups dry (5–10 minutes) before attempting to process slides on the instrument.

Use the Clean System feature to help move instrument mechanisms out of the way. See “Clean System” on page 8.2.



**Figure 8-5 Clean Slide Holder Pneumatic Suction Cups**

# 8

## MAINTENANCE

### SECTION C

## EMPTY THE WASTE BOTTLE

Waste resulting from sample processing is routed to and stored in the waste bottle.

The instrument senses when the waste bottle is full and displays a message to empty the waste (see Figure 8-7). Or the waste may be emptied during routine maintenance of the instrument.

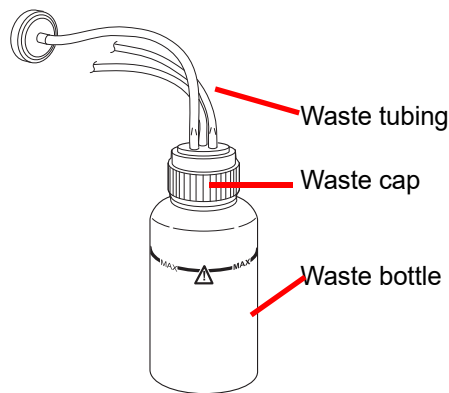

**Figure 8-6 Waste Bottle**

### Emptying the Waste Bottle

From the Admin Options screen, press the **Empty Liquid Waste** button. Then touch the **Continue** button to allow the system to vent the waste bottle, so that the cap can easily be removed.

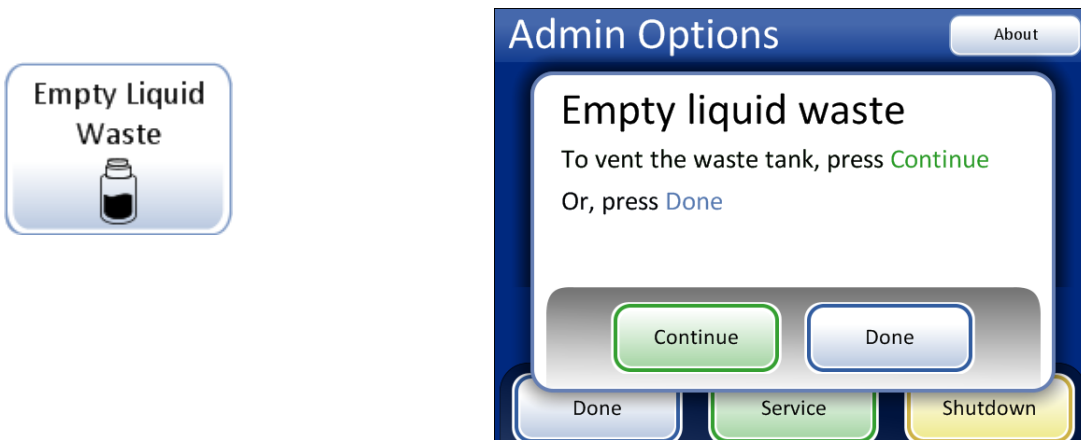

**Figure 8-7 Empty Liquid Waste Button and Message**

The system can be heard to vent, which depressurizes the waste bottle. It takes about 10 seconds.

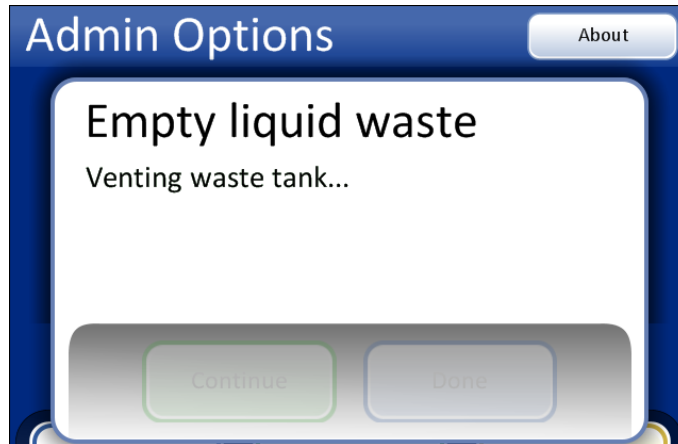

**Figure 8-8 Venting the Waste Bottle**

A message prompts for the operator to dispose of the waste according to the instructions in this manual. Figure 8-9.

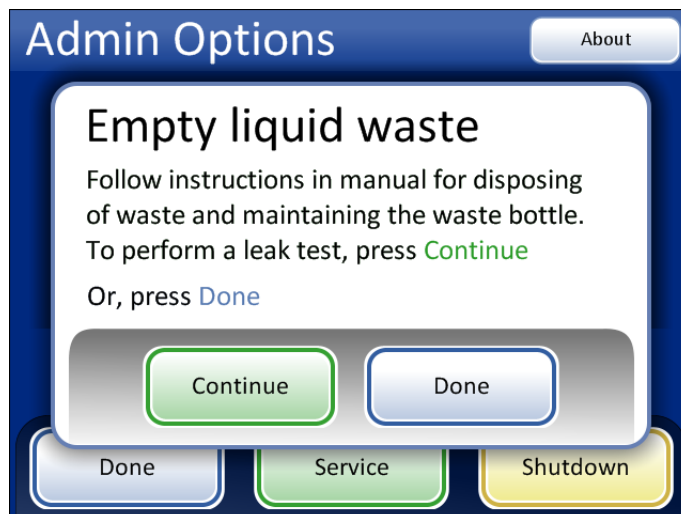

**Figure 8-9 Empty and Maintain the Waste Bottle**

1. To remove the waste cap, rotate the waste cap with one hand while holding the waste bottle in place with the other hand.
  - If the waste tubing becomes dislodged from the waste cap during this process, reconnect the tubing before continuing.

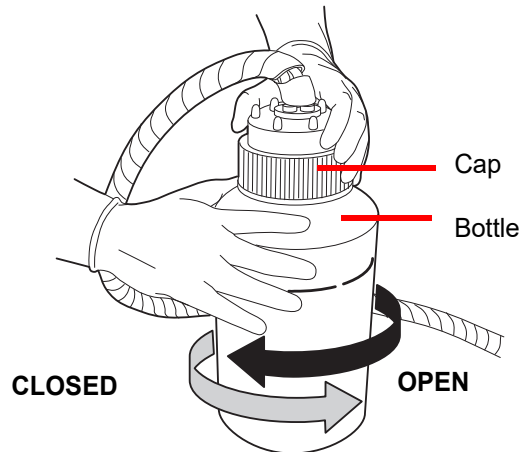

**Figure 8-10 Opening/Closing the Waste Bottle**

**WARNING:**

Hazardous Waste

Toxic Mixture

Flammable Liquid and Vapor

2. Place the transport cover onto the waste bottle for transporting to the waste disposal area.
3. Dispose of the liquid waste from the waste bottle according to your laboratory guidelines. Dispose of all solvents as hazardous waste. Follow state, local, provincial and federal or county guidelines. As with all laboratory procedures, universal precautions should be followed.
4. Before reattachment, inspect the O-ring seal on the inside of the waste cap for debris. See Figure 8-11.
  - If debris is present, clean the seal with water using a lint-free wipe.
  - Apply a thin layer of vacuum grease to the O-ring.

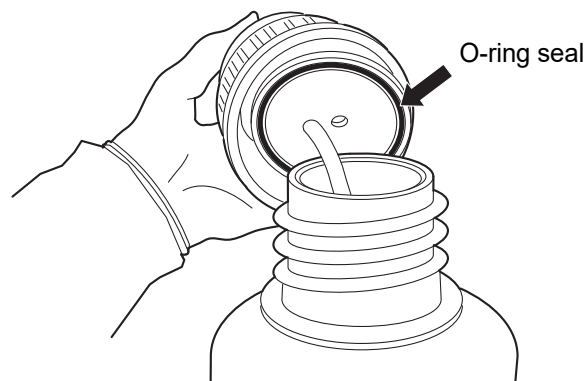

**Figure 8-11 Inspect Waste Bottle O-Ring Seal**



5. Return the waste bottle back to its original location and retighten the waste cap onto the bottle.
  - Verify that the waste cap is firmly tightened and confirm that the waste tubing is not pinched or twisted.

Press the **Next** button to perform a leak test. It also measures the fluid level to verify that the waste bottle has been emptied. This repressurizes the waste bottle and checks that the system can hold pressure. See Figure 8-12.

**Note:** The leak test **MUST** be run after emptying the bottle.



**Figure 8-12 Waste System Leak Test**

Press the **Done** button when complete.

### Waste Bottle Connection

The waste bottle will be connected to the system at the time the instrument is installed. However, if the waste bottle and the tubing harness should be removed entirely (for overall replacement, replacement of the waste filter, cleaning, etc.) the following steps describe connecting the tubing correctly.

1. The waste bottle should be placed at the same height or below the ThinPrep 5000 processor. Do not place the waste bottle above the instrument.
2. Ensure that the waste bottle cap is tightly secured. The waste bottle must rest in an upright position. Do not allow the waste bottle to lay on its side.
3. Locate the three waste bottle connections at the rear of the ThinPrep 5000 processor. See Figure 8-13. Ensure that the buttons of the connectors are in the down/inward position.

# 8

## MAINTENANCE

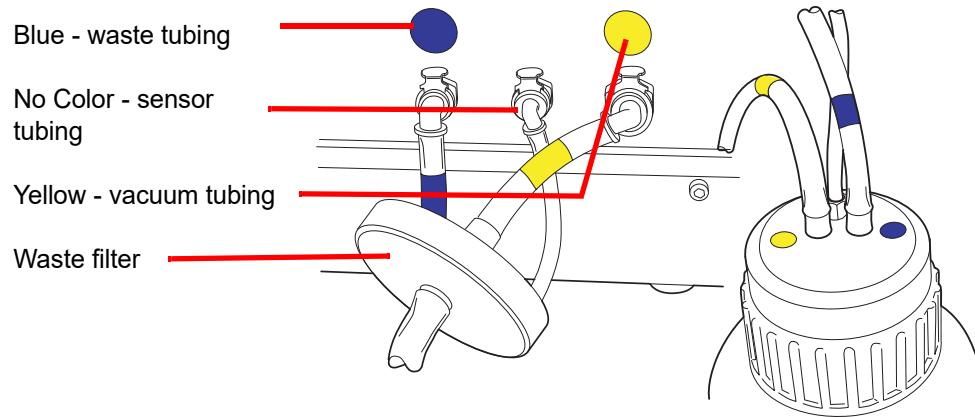

**Figure 8-13 Waste Bottle Tubing Connections**

4. Connect the color-coded waste tubing connectors to the corresponding connectors located in the rear of the instrument. When the proper connection has been established, the buttons on the connectors pop up/outward with a click sound. The L-shaped connector should be pointed downward.
  - Yellow = vacuum
  - Blue = waste
  - No Color = pressure sensor

**CAUTION:** Do not mismatch tubing connections. This may result in damage to your processor.

### SECTION D

## CLEAN THE TOUCH SCREEN

As needed, clean the user interface touch screen with a lightly dampened lint-free cloth. From the Admin Options screen, press the **Clean Screen** button, Figure 8-14.

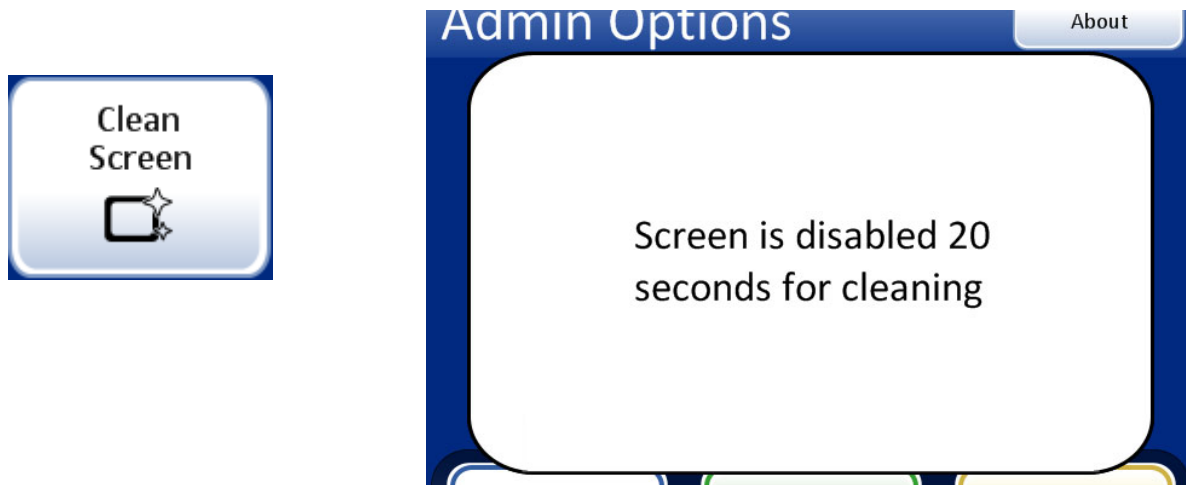

**Figure 8-14 Touch Screen Disabled for Cleaning**

The system disables the touch screen for 20 seconds so that the screen may be cleaned without inadvertently activating buttons or having to power off the instrument.

**SECTION  
E**

## **CLEAN INPUT CAROUSEL AND DUST COVER**

### **Input Carousel**

As needed, clean the input carousel by wiping it down with soap and water. Allow it to dry thoroughly before using it.

### **Dust Cover**

Wipe down the carousel dust cover with a clean cloth and soap and water.

# 8

## MAINTENANCE

### SECTION F

## CHANGE ABSORBENT PADS

There are two absorbent pads on the ThinPrep® 5000 processor that absorb drips that may result from processing. One is located at the base of the filter plug, and the other is on the top of the evaporative cover over the fixative bath carousel. See Figure 8-15.

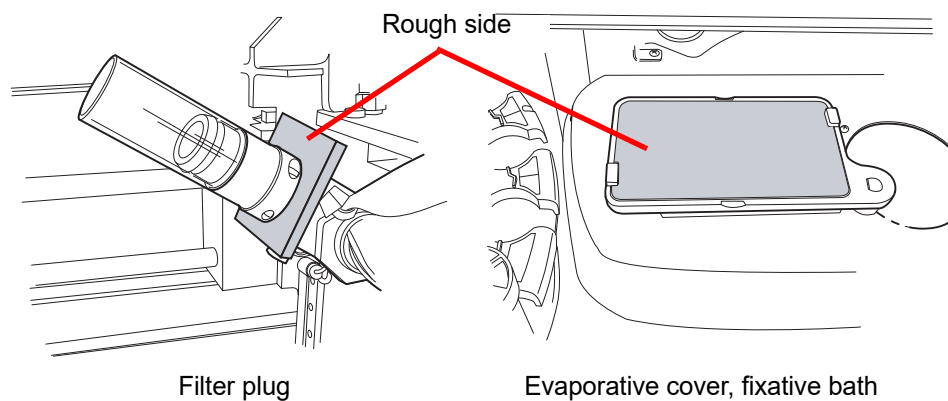

**Figure 8-15 Absorbent Pads**

Use the Clean System feature to help move instrument mechanisms out of the way. See “Clean System” on page 8.2.

Replace the pads once a year, or as desired. The pads can be disposed of as regular waste, unless they are dripping wet, then dispose of as hazardous waste.

When the pads are replaced, notice that one side is rough and absorbent and one side is smooth and finished. The rough side should face outward to catch any drips.

Refer to Ordering Information for ordering pads.

On a more frequent basis if desired, the pads can be washed and returned to the instrument. Clean with soap and water. Or soak in a diluted bleach rinse followed by a 70% alcohol rinse.

SECTION  
G

## REMOVE AND CLEAN DRIP TRAYS

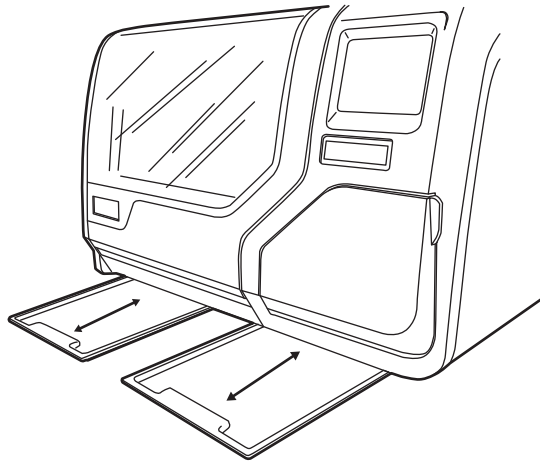
**Figure 8-16 Drip Trays**

Two plastic drip trays are located on the underside of the ThinPrep 5000 processor. They slide all the way out for inspection and cleaning.

Wash them down with soap and water. Allow them to dry thoroughly before returning them to the processor.

# 8

## MAINTENANCE

### SECTION H

## REPLACING THE USER ACCESSIBLE FUSES

**WARNING:** Instrument Fusing.

There are two user-accessible fuses located on the rear of the instrument, just above the power cord module (Figure 8-17). If the instrument fails to operate, the fuses can be replaced as outlined below. Hologic Field Service can replace the fuses as needed.

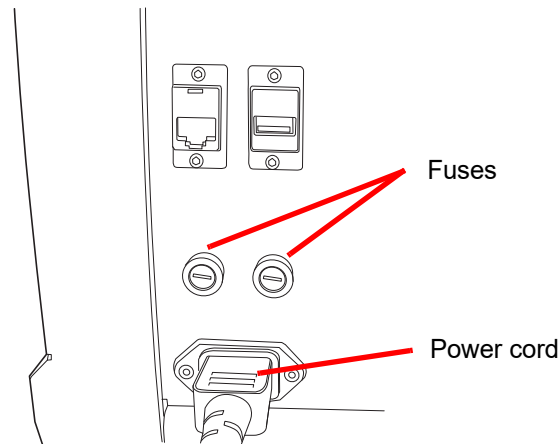

**Figure 8-17 Location of User Accessible Fuses**

1. Make sure the power switch is in the OFF position.
2. Remove the power cord from the receptacle on the instrument.
3. Using a small, flat-head screwdriver, turn each fuse head counterclockwise 1/4 turn. The fuse, which is slightly recessed in the fuse holder when latched, will pop forward slightly when it has been turned far enough to be released from the catches.
4. Pull the fuses out of the receptacles. They may be discarded as regular waste.
5. Insert two new 15A/250V 3AB SLO-BLO fuses (P/N 53247-015).

**Note:** Hold the fuse by the metal ends.

6. Using the flat-head screwdriver, press each fuse cover into the receptacle while turning clockwise 1/4 turn. The fuse can be felt to engage with the catches and it will be slightly recessed into the fuse holder.
7. Reattach the power cord to the instrument.
8. Turn the instrument power switch ON.

If the instrument fails to operate, contact Hologic Technical Support.





## MAINTENANCE

This page intentionally left blank.





# Chapter Nine

---

## Troubleshooting

### SECTION A

#### GENERAL

There are three categories of error/status that the system can generate:

- Sample Processing Errors
- User Correctable Batch Errors
- System Errors

### SECTION B

#### SAMPLE PROCESSING ERRORS

At the conclusion of batch processing, sample errors are reported on the batch report. Sample errors occur when a sample vial is being processed. They are “sample specific” and usually only affect the sample vial being processed. A slide is not made and the operator must resolve the event and process the vial in another batch.

The error only appears on the batch report. It will not be recorded in the error log.

When a sample processing error occurs:

- If a vial has been picked up, the system will return it to the input carousel.
- If a filter has been picked up, it will be disposed of.
- If a slide has been picked up but not used, it will be returned to the input carousel.



## TROUBLESHOOTING

**Table 9.1 Sample Processing Errors**

Error	Description	Possible Cause	Corrective Action
<b>5000 - Sample Is Dilute</b>	This error message indicates the entire sample was utilized in preparing the slide. This message is only a notification; the slide is processed and may be adequate.	This is usually caused by a low concentration of cells in the sample. This message usually indicates a problem with the sample that was collected, rather than an issue with the instrument and its mechanisms.  <b>Note:</b> A slide is made from the sample vial.	Gyn slides - If the slide is satisfactory for screening purposes, no further action is necessary.  If the slide is inadequate, follow laboratory procedure for reporting unsatisfactory specimens.  Non-gyn slides - If there is additional sample material available, make another slide with more cells if possible.
<b>5001 - Sample Too Dense</b>	The sample is too dense for the instrument to make a satisfactory slide.	The sample is too dense for the instrument to make a satisfactory slide.	This is for Non-gyn samples only. Shake or vortex sample for 8–12 seconds. Then dilute sample by 20:1. Place 1 mL of sample into a new PreservCyt Solution vial and process again.
<b>5002 - Failed to Uncap Vial</b>	The vial could not be uncapped. The sample was not processed and a slide was not made.	Vial cap is screwed on too tight. Mechanical failure prevented uncapping of the vial Damaged vial cap	Check the vial and cap. Make sure the plastic over wrap has been removed from the vial. Loosen and retighten the cap and process again. Replace with new vial cap.

**Table 9.1 Sample Processing Errors**

<b>Error</b>	<b>Description</b>	<b>Possible Cause</b>	<b>Corrective Action</b>
<b>5003 - Failed to Read Vial ID</b>	The barcode on the vial could not be read or is an invalid format. The sample was not processed and a slide was not made.	<p>The barcode label is missing, damaged, or printed at poor quality..</p> <p>The barcode label is not applied to the vial properly.</p> <p>Wrong type of barcode was applied.</p> <p>Failure of the barcode reader</p>	<p>Examine the barcode label to see if it is missing, damaged, or printed poorly. Replace, if necessary (refer to “Adhering Vial Labels” on page 7.3).</p> <p>Examine the barcode label and ensure it is the correct format. (Refer to “Configure Barcodes” on page 6.28.)</p> <p>Make sure nothing is blocking the vial barcode reading station (see Figure 8-2).</p> <p>Contact Technical Support if the problem persists.</p>
<b>5004 - Failed to Read Slide ID</b>	The slide ID could not be read or is an invalid format. The sample was not processed and a slide was not made.	<p>No slide present.</p> <p>Slide present with missing or damaged label.</p> <p>System setting for OCR/Barcode label conflicts with the type of label on the slide.</p> <p>Mechanical misalignment or failure of the reader.</p>	<p>Make sure a slide is present and is labeled correctly. (Refer to “Adhering Vial Labels” on page 7.3.)</p> <p>Check the slide label setting on the instrument to see if it matches the type of slide label being used. Refer to “Configure Barcodes” on page 6.28.</p> <p>Make sure nothing is blocking the slide ID reader (see Figure 8-2).</p> <p>Contact Technical Support if the problem persists.</p>



## 9 TROUBLESHOOTING

**Table 9.1 Sample Processing Errors**

<b>Error</b>	<b>Description</b>	<b>Possible Cause</b>	<b>Corrective Action</b>
<b>5005 - Failed to tighten vial cap</b>	The vial could not be tightened prior to the dispersion step.	Damaged vial cap.  Mechanical failure prevented tightening of vial cap.	Check the vial and cap. Make sure the cap does not have broken cap ridges. Replace a damaged vial cap with a new vial cap.  With an undamaged vial cap, loosen and retighten the cap and process again.
<b>5006 - Slide Not Found</b>	A slide is not sensed in the slide gripper when attempting pickup. The sample is not processed and no slide is made.  <b>Note:</b> This error is only valid when using an Advanced sequence process - 'Disable Slide ID Match' or 'Multiple Slides per Vial'.	Slide not present in carousel slot  Slide leaning out of position in carousel slot  Mechanical misalignment or failure of the slide gripper	Confirm that a slide is present in the carousel and that it is in position.  Attempt to reprocess the sample. Contact Technical Support if the error persists.
<b>5007 - Invalid Vial ID</b>	Barcode on the vial is not a valid format.	Vial ID is in the wrong format to become an OCR slide ID.  The barcode configuration for the vial ID does not match the vial IDs used in your laboratory.	Check and correct the Vial ID barcode configuration on the instrument.  Use and pass the Test Settings test prior to running samples. Refer to "Configure Barcodes" on page 6.29.
<b>5008 - Invalid Slide ID</b>	Barcode on the slide is not a valid format.	Barcode data on the slide is too long or too short.  The barcode configuration for the slide ID does not match the slide IDs used in your laboratory.	Check and correct the Slide ID barcode configuration on the instrument.  Use and pass the Test Settings test prior to running samples. Refer to "Configure Barcodes" on page 6.29.

**Table 9.1 Sample Processing Errors**

<b>Error</b>	<b>Description</b>	<b>Possible Cause</b>	<b>Corrective Action</b>
<b>5009 - Duplicate Vial ID</b>	A sample vial has the same ID as one that has already been processed in the batch. The vial with the duplicate ID will not be processed.	<p>Multiple vials were labeled with the same ID number.</p> <p>The vial ID barcode configuration is not set up to correctly identify the section of the vial ID label that is the accession ID.</p>	<p>Check the sample IDs and confirm that they are duplicates. A slide was only made from the first vial.</p> <p>The patient information must be checked and reconciled for both vials. Relabel the second vial and reprocess.</p> <p>Correct the vial ID barcode configuration on the instrument. Refer to "Configure Vial ID" on page 6.29</p>
<b>5010 - Insufficient Fluid or Filter Not Present</b>	The vial does not contain enough fluid to process properly. (17 mL is the minimum required volume.) The sample was not processed and a slide was not made.	<p>Filter not present</p> <p>The vial leaked.</p> <p>Pneumatic system error</p> <p>Preparation error resulting in not enough fluid</p> <p><b>Note:</b>See "OPTIONAL INSTRUCTIONS FOR ANCILLARY TESTING" on page 7.19 for aliquot removal instructions.</p> <p><b>Note:</b>This check is not performed when using multiple slides per vial sequence processing.</p>	<p>Make sure a filter is present and loaded correctly, with the open end up.</p> <p>Examine the vial to make sure it is not leaking. Place sample into another vial if it is damaged.</p> <p>Check the fluid level in the vial. Add PreservCyt Solution if the level is below the frosted line on the vial. Do not overfill beyond the frosted line. Reprocess the sample.</p>



## 9 TROUBLESHOOTING

**Table 9.1 Sample Processing Errors**

Error	Description	Possible Cause	Corrective Action
<b>5011 - Excessive Fluid</b>	When introducing the filter into the vial, the system detects the fluid level too early. (21 mL is the maximum allowed volume.) There is too much fluid in the vial. The sample was not processed and a slide was not made.	Too much fluid in the vial Pneumatic system error	Examine the vial and see if the level of the fluid is above the frosted line on the vial. If it is necessary to reduce the sample volume to between 17 mL and 21 mL, save any excess fluid in an appropriate container. Reprocess the vial.
<b>5012 - Vial/Slide ID Mismatch</b>	The vial and slide IDs were both successfully read, but did not match. The sample was not processed and no slide was made.	Slides placed in wrong carousel slot  Incorrect labeling of slides or vials  The slide ID barcode configuration is not set up to correctly identify the section of the vial label that is the accession ID for the sample.	Examine the vial and slide IDs to confirm they do not match.  See if the slide has been filed in the wrong slot on the carousel. (Look at subsequent IDs, in case the mistake was perpetuated within the carousel.)  Reconcile the patient information with the correct ID. Relabel, if necessary.  Correct the slide ID barcode configuration on the instrument. Refer to "Configure Slide ID" on page 6.34
<b>5013 - End of Vial or Filter Not Present in Multiple Slides per Vial</b>	The entire sample was consumed during the advanced process sequence 'Multiple Slides per Vial'. This error only occurs during Multiple Slides per Vial mode, which does not check for fluid level or dilute sample. The slide was processed, but should be checked for adequacy.	Filter not present  All fluid in the vial was consumed.  Pneumatic system failure	Make sure a filter is present. If Multiple Slides per Vial mode is being used, there is not enough sample to process the desired number of slides. Examine the vial to see if it is empty.

**Table 9.1 Sample Processing Errors**

<b>Error</b>	<b>Description</b>	<b>Possible Cause</b>	<b>Corrective Action</b>
<b>5014 - IDs on Vial and Slide Could Not Be Read</b>	Failure to read both vial and slide IDs. The sample was not processed and no slide was made.	<p>Labels not present, damaged, or printed at poor quality.</p> <p>Mechanical failure of ID readers</p>	<p>Examine the vial barcode label to see if it is missing, damaged, or printed poorly. Replace, if necessary (refer to “Adhering Vial Labels” on page 7.3).</p> <p>Make sure a slide is present and is labeled correctly. (Refer to “Slide Labeling Requirements” on page 7.4.)</p> <p>Examine the vial and slide labels and ensure they are the correct format. (Refer to “Slide barcode label format” on page 7.4.)</p> <p>Make sure nothing is blocking the vial barcode reading station or the slide reader (see Figure 8-3).</p> <p>Contact Technical Support if the problem persists.</p>
<b>5015 - Duplicate Slide ID</b>	<p>Multiple slides were labeled with the same ID number.</p> <p>The vial with the duplicate will not be processed.</p>	<p>Multiple slides were labeled with the same ID number.</p> <p>The vial ID and/or slide ID barcode configuration is not set up to correctly identify the section of the vial label that is the accession ID and recognize it on the slide ID.</p>	<p>Check the sample IDs and confirm that they are duplicates. A slide was only made from the first vial.</p> <p>The patient information must be checked and reconciled for both vials.</p> <p>Relabel the second slide and reprocess.</p> <p>Correct the slide ID barcode configuration on the instrument. Refer to “Configure Slide ID” on page 6.35.</p>





## TROUBLESHOOTING

**Table 9.1 Sample Processing Errors**

<b>Error</b>	<b>Description</b>	<b>Possible Cause</b>	<b>Corrective Action</b>
<b>5017 - Obstruction in Vial</b>	Filter meets resistance when moving into the vial.	Possible object left in vial such as collection device	Examine the vial to see if there is a foreign object in it.
<b>5018 - Failed to Place Vial in Dispersion Cup</b>	The vial could not be inserted properly into the dispersion well. The sample was not processed and a slide was not made.	<p>Possible obstruction in the dispersion well.</p> <p>Possible obstruction on the bottom or side of the vial, such as too many labels.</p> <p>Misshapen vial cap on the vial.</p>	<p>Check the dispersion well and remove the obstruction.</p> <p>Re-label the vial.</p> <p>Reprocess the vial.</p>
<b>5100 - Processing Error</b>	--	--	If the error persists, contact Technical Support.
<b>5101 - Processing Error</b>	--	--	If the error persists, contact Technical Support.
<b>5102 - Processing Error</b>	--	--	If the error persists, contact Technical Support.
<b>5104 - Processing Error</b>	--	--	If the error persists, contact Technical Support.
<b>5105 - Pneumatic Error</b>	--	--	If the error persists, contact Technical Support.

**Table 9.1 Sample Processing Errors**

<b>Error</b>	<b>Description</b>	<b>Possible Cause</b>	<b>Corrective Action</b>
<b>5106 - Processing Error</b>	A processor timeout error, usually caused by a leak or other pneumatic error condition. The sample was not processed and no slide was made.	Leak around the filter plug assembly  Punctured filter membrane  Occluded filter membrane  Sensor line pinched or open Pneumatic error	Check to see that nothing is interfering with the filter plug and that the filters are loaded correctly.  Check to see if the sample vial contains a portion of the collection device or other foreign matter that might puncture the filter.  Contact Technical Support if the problem persists.

SECTION  
C

## BATCH PROCESSING ERRORS

Batch processing errors are errors that the system is capable of recovering from with user intervention. The errors occur during the processing of a batch. When the system encounters a batch error condition, the batch halts (terminates, or pauses, depending on the cause) and signals the error via a message on the user interface and by sounding the audible alarm, if it is enabled. Some errors may be detected at the start of a batch, which will stop it from commencing.

The error only appears on the batch report. It will not be recorded in the Error Log.

**Table 9.2 Batch Processing Errors**

Error	Description	Possible Cause	Corrective Action
<b>4000 - No Empty Tubs</b>	No empty fixative baths are present. Baths containing one or more slides are present. The batch will not start.	An empty fixative bath was not loaded.  Sensor failure in detecting empty tubs  A tub was loaded with one or more slides in it.	At least one bath with no slides must be present for a batch to begin. If at least one bath is present and this error occurs, contact Technical Support.
<b>4001 - No Vial Detected (Multiple Slides per Vial mode)</b>	The system did not detect a vial in slot 1 of the carousel when starting a Multiple Slides per Vial batch. The batch will not start.	Vial not loaded in slot 1 of the carousel Sensor malfunction	Refer to "SELECT THE SAMPLE PROCESSING SEQUENCE" on page 7.11 for running the multiple slides per vial sequence. If at least one vial is present and this error occurs, contact Technical Support.
<b>4002 - Extra Vials Detected (Multiple Slides per Vial mode)</b>	The system detected more than one vial when starting a Multiple Slides per Vial batch. The batch will not start.	More than one vial is in the carousel. Sensor malfunction	Make sure there is a vial in slot 1 of the carousel. No other vials may be loaded into the carousel.
<b>4004 - Extra Vials Detected (Disable Slide ID Match mode)</b>	More than one vial was detected when the system started a batch in Disable Slide ID Match mode. The batch will not start.	More than one vial is in the carousel.  Sensor malfunction	Refer to "SELECT THE SAMPLE PROCESSING SEQUENCE" on page 7.11 for running the Disable Slide ID Match sequence.

**Table 9.2 Batch Processing Errors**

<b>Error</b>	<b>Description</b>	<b>Possible Cause</b>	<b>Corrective Action</b>
<b>4005 - No Vials Found</b>	No vials were detected while starting a batch. There must be at least one vial to start a batch.	No vials are in the carousel.  Sensor malfunction	At least one vial must be in the carousel to start a batch. If at least one vial is present and this error occurs, contact Technical Support.
<b>4006 - Slide Not Detected at Drop Off</b>	The system could not detect the presence of a slide in the fixative bath after putting one there. The batch terminates.  <b>Note:</b> This error only occurs if the first slide deposited into the bath is not detected.	Fixative bath did not have a staining rack in it to hold the slide.  Failure of the slide sensor	Inspect the fixative bath to see if a slide was deposited into it and if there is a staining rack to hold it. Add a staining rack if it is not present.  Contact Technical Support if a staining rack and slide are present.
<b>4007 - No Slide Detected in First Position (Multiple Slides per Vial mode)</b>	A slide was not detected at position 1 of the carousel when the batch was beginning. The batch will not start.  <b>Note:</b> Only the first slide is detected in this mode. The subsequent number of samples processed out of the vial is not counted. The process sequence is over when no more filters and slides are detected, or when the vial is too empty for the system to process another slide.	A slide was not placed into slot 1 of the carousel prior to starting the batch.  Sensor failure	Place a slide into slot 1 of the carousel. If a slide is in position 1 and this error occurs, contact Technical Support.



## 9 TROUBLESHOOTING

**Table 9.2 Batch Processing Errors**

<b>Error</b>	<b>Description</b>	<b>Possible Cause</b>	<b>Corrective Action</b>
<b>4008 - Vial Not Successfully Uncapped (Multiple Slides per Vial mode)</b>	<p>Failed to uncapp the vial during the batch</p> <p><b>Note:</b>This is a batch error in Multiple Slides per Vial mode since there is only one vial used in this process sequence. In normal processing, this is a sample error (5002) since the system can go on to the next sample.</p>	<p>Vial cap is screwed on too tight.</p> <p>Mechanical failure prevented uncapping of the vial.</p>	<p>Check the vial and cap. Make sure the plastic over wrap has been removed from the vial. Loosen and retighten the cap and process again. If the error persists, contact Technical Support.</p>
<b>4009 - Positive Tank Pressure</b>	<p>Positive tank failed to reach transfer pressure.</p> <p>(Pressure within the filter required for cell transfer from the filter membrane to the microscope slide did not occur.)</p>	<p>The filter might be punctured or defective.</p> <p>The system has a pressure leak.</p>	<p>Check that the filters are not defective. Reprocess the vial.</p> <p>If the error persists, contact Technical Support.</p>
<b>4010 - Bad Fluid Level (Multiple Slides per Vial mode)</b>	<p>Fluid level is incorrect (MSVP mode).</p>	<p>The system detected that the initial fluid level in the vial was more than the maximum of 21 mL or below the minimum of 17 mL.</p>	<p>Check that the fluid level in the sample vial is between 17 mL and 21 mL when initiating processing in the multiple slides per vial mode.</p>
<b>4011 - Batch Processing Error</b>	<p>The system has encountered a positive pressure problem during cell transfer. A slide was not made.</p>	<p>The filter might be punctured or defective.</p> <p>The system has a pressure leak.</p>	<p>Check that the filters are not defective. Reprocess the vial.</p> <p>If the error persists, contact Technical Support.</p>

**Table 9.2 Batch Processing Errors**

<b>Error</b>	<b>Description</b>	<b>Possible Cause</b>	<b>Corrective Action</b>
<b>4012 - Empty Liquid Waste Tank</b>	The liquid waste tank is full and should be emptied. A batch cannot be started until this has been performed.	The system detected the waste tank was full via a pressure measurement.	Empty the liquid waste tank (refer to “Emptying the Waste Bottle” on page 8.6). The leak test <b>MUST</b> be run after emptying the waste tank.  If the message occurs and the tank is empty, run the leak test. If the leak test passes, attempt to run a batch. If the leak test fails, contact Technical Support.
<b>4051 - Invalid Slide ID (3 in a row)</b>	Three consecutive occurrences of an invalid slide ID	Barcode data on the slide is too long or too short.  The barcode configuration for the slide ID does not match the slide IDs used in your laboratory.	Use and pass the Test Settings test prior to running samples. Refer to “Configure Barcodes” on page 6.28.
<b>4052 - Failed to Read Slide ID (3 in a row)</b>	Three consecutive occurrences of a failure to read slide ID	No slides present.  Slides present with missing or damaged label.  Mechanical misalignment of the reader	Check and correct the Slide ID barcode configuration on the instrument.  If slides are present and labeled, contact Technical Support.

SECTION  
D

## SYSTEM ERRORS

System errors are errors that the ThinPrep 5000 processor is not capable of recovering from without user intervention. The current batch terminates and the system attempts to create a batch report. A system error is an error that will most likely require field service assistance. A user may choose or be instructed to restart the system. The error is reported to the error log.

### Clearing a System Error

When a system error has been detected, the system will usually:

- Attempt to recap the vial and attempt to deposit a slide in a fixative bath
- Move mechanisms out of the way, release the input carousel lock, unlock the doors and return to an idle state.
- Display the error message and sound the audible alarm, if enabled (see Figure 9-1.) The system attempts to recover (a minute or less).

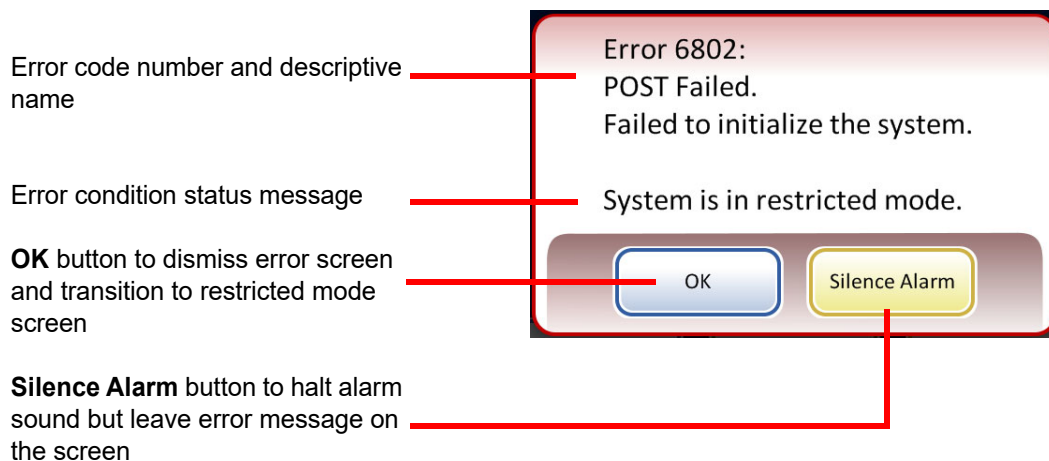

**Figure 9-1 System Detected an Error**

If the system cannot recover, it attempts to move the mechanisms out of the way, turns off the transport arm motors so the operator can easily move the slide and filter transport arms and releases the input carousel so that it can spin freely. The doors unlock for user access.

### Restricted Mode

If the instrument cannot fully recover from an error condition, the application will transition to restricted mode. This allows the operator to access some functions, but the system cannot process samples until the error is resolved. After acknowledging the error message, the user interface

displays the **Admin Options** screen. The **Reports** button is available, where you can review or download the Error History report (which will have captured the error code). The **Service** access button is available if the system cannot recover and requires a service visit. The **Shutdown** button is available, in order to restart the instrument, which usually clears a system error.

**CAUTION:** Do not restart the instrument with a USB key in any of the ports.



**Figure 9-2 Restricted Mode Admin Options Screen**

To recover from an error requiring shutdown, press the **Shutdown** button.

Wait for the computer to turn off (wait until the touch screen interface goes blank). Then turn off the power switch on the right side of the instrument. After a few seconds of the power being fully off, turn the processor on again and let it boot up. The main screen should be displayed when the system is ready to process.

If the restricted mode screen appears, contact Technical Support.

### Clear Media

For some system errors, a “Clear media” message dialog may display. This prompts the operator to check the mechanisms along the processing path to remove a filter, vial or slide that may have been left in process. The display provides buttons that will release the holding pressure on those media for removal. Each button must be pressed before the message box will close. See Figure 9-3.

**Note:** The media will drop as soon as the pressure is released. Hold the item before pressing the button so it won't fall.



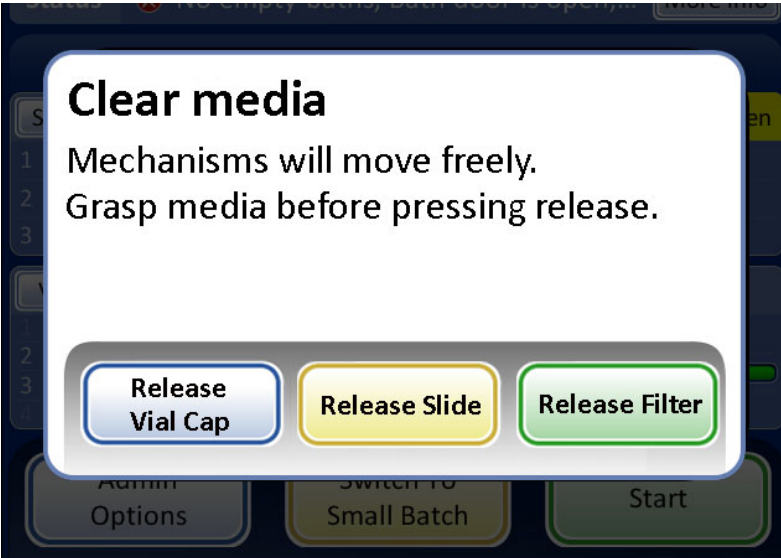

**Release Vial Cap** will open the fingers of the vial gripper to drop the vial cap.

**Release Slide** will release the slide gripper fingers to let go of the slide and release the suction vacuum of the slide holder cups at the cell transfer area.

**Release Filter** vents the filter plug, so that the filter may be pulled off.

**Figure 9-3 Clear Media Screen**

It may be difficult to view and reach the filter or vial cap. Gently slide the filter/vial transport arm to the middle of the processing area to access the media. The slide transport arm may be moved in the same way.

### Release Filter

The filter plug keeps a slight pressure in the filter once it has been picked, to keep it from dropping. To remove a filter that is left on the filter plug, press the **Release Filter** button. Then gently pull the filter off.

**CAUTION:** Never forcibly remove a filter from the filter plug without releasing the system pressure, as damage to the instrument could occur.

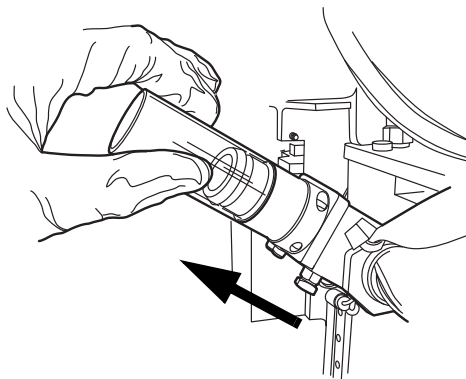

**Figure 9-4 Release Filter**

## Release Vial Cap

The vial gripper fingers remain closed in an error condition, so that a vial will not drop. Move the vial transport arm toward the middle of the instrument and then press the **Release Vial Cap** button to open the gripper and retrieve the vial. See Figure 9-5.

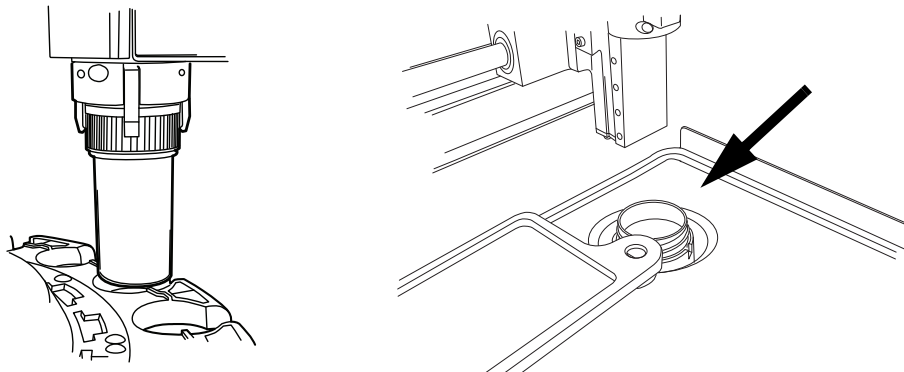

**Figure 9-5 Release Vial, Check Dispersion Well**

**Note:** Often just the vial cap is in the mechanism. Carefully check the dispersion well and retrieve the vial, if necessary. Manually recap the vial. See Figure 9-5.

## Release Slide

**Note:** Locate where the slide is before pressing the release button.

A slide might be located in the slide gripper of the slide transport arm. The slide grippers remain closed after picking a slide until it has been handed off to the slide holder of the cell transfer area. To release the slide from the gripper, press the **Release Slide** button.

The slide may be left on the suction holders of the cell transfer area. When the **Release Slide** button is pressed, the suction vacuum is released.

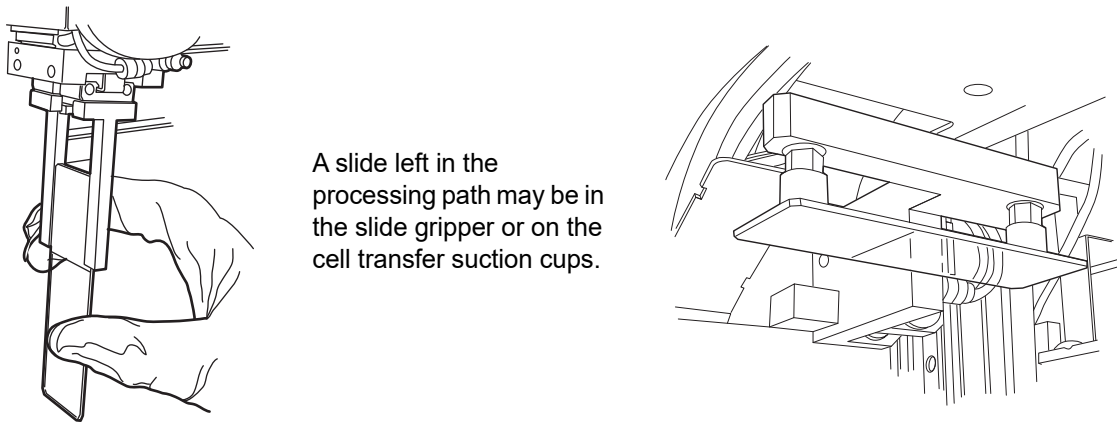

A slide left in the processing path may be in the slide gripper or on the cell transfer suction cups.

**Figure 9-6 Release Slide**



## System Error Code

A system error has a two-part error code associated with it. The first four digits represent the error category and the following characters represent the status of the particular electromechanical device at the time the fault occurred. See Figure 9-7.

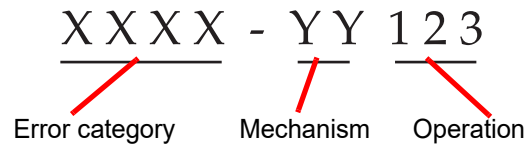

**Figure 9-7 System Error Code**

The error codes will be logged in the Error History report. The report displays the last 100 errors, but keeps up to 3 years' worth in the system database.

In most cases, the "Clear media" dialog box will display. Check that the mechanisms are clear and begin a new batch.

If an error is persistent, contact Technical Support.

### **6000 series - Slide Handling Errors**

### **6100 series - Database Errors**

### **6200 series - Filter and Vial Handling Errors**

### **6300 series - Pneumatic Errors**

### **6400 series - Input Carousel Errors**

(This includes main door lock/unlock errors)

### **6500 series - Output Carousel Errors**

(This includes output door lock/unlock errors)

### **6700 series - UPS Errors**

### **6800 series - Machine/General Errors**

## 10. Staining and Cover slipping

## 10. Staining and Cover slipping

# Chapter Ten

---

## Staining and Coverslipping

### SECTION A

### GENERAL

Following is a description of *recommended guidelines* for fixation procedures, staining protocols, and coverslipping methods.

**Note:** There is wide variation among laboratories in fixation, staining, and coverslipping methods employed for cytologic specimens. The thin layer characteristics of ThinPrep® processor-prepared slides allow precise assessment of the effects of these differences in protocols and allows the laboratory personnel to optimize their methods by following the general guidelines provided in this section. These guidelines are recommendations and should not be considered absolute requirements.

### SECTION B

### FIXATION

The ThinPrep 5000 processor deposits completed slides into a staining rack immersed in a fixative bath that contains 95% reagent alcohol or 95% ethyl alcohol. Use the following procedure to fix ThinPrep microscope slide preparations.

- **Gyn slides:** ThinPrep microscope slides should be fixed for at least 10 minutes prior to staining.
- **For Gyn slides intended for use with the ThinPrep® Imaging System:** ThinPrep microscope slides should be fixed for at least 10 minutes prior to staining. If the slides must be shipped to another site prior to staining, CellFyx™ Solution fixative must be applied.

**Note:** No other spray fixative has been validated for use with the ThinPrep Imaging System. Contact Hologic Customer Service for ordering. See the instructions for use that come with the fixative solution.

**Note:** If the slides are being prepared for use with the ThinPrep Imaging System, please refer to the Image Processor Operator's Manual first.

# 10

## STAINING AND COVERSLIPPING

- **Non-Gyn slides:** ThinPrep microscope slides should be fixed for at least 10 minutes prior to staining or application of fixative spray.

**Note:** Some non-gyn slides will drop into a dry bath or PreservCyt Solution, depending on the type being run.

Change the fixative every 100 slides, or once per day, whichever comes first.

### SECTION C

## RECOMMENDED STAINING GUIDELINES

Staining times are different for ThinPrep-prepared slides in comparison to conventional preparations and should be adjusted accordingly.

- Use graded concentrations of alcohol (50% or 70%) to lower the potential for osmotic shock or possible cell shedding during staining.
- The use of mild bluing solutions and dilute acid baths will optimize nuclear staining and minimize possible cell shedding. Hologic recommends the use of a dilute Lithium Carbonate solution, or Ammonium Hydroxide solution as the bluing solution.
- Avoid the use of strong salt solutions, like *Scotts Tap Water Substitute*.
- Bath solution heights should completely cover the slides to reduce the chance of cell shedding during staining.
- For optimal results, slides should be agitated for at least 10 dips in each bath.

Below are the maximum concentrations to be used for the following solutions during the staining process:

Hydrochloric acid (HCl) 0.025%

Lithium Carbonate (bluing) baths 10mg per 1 liter<sup>1</sup>

Acetic acid 0.1%

Ammonium Hydroxide 0.1%

For Gyn slides intended for use with the ThinPrep Imaging System, consult recommended staining protocols found in the ThinPrep Stain User's Manual.

1. Refer to Bales, CE. and Durfee, GR. *Cytologic Techniques* in Koss, L, ed. *Diagnostic Cytology and its Histopathologic Basis*. 3rd Edition. Philadelphia: JB Lippincott. Vol. II: pp 1187–1260 for details

**Table 10.1: Hologic Staining Protocol**

	<b>Solution</b>	<b>Time*</b>
1.	70% Reagent Alcohol	1 minute with agitation
2.	50% Reagent Alcohol	1 minute with agitation
3.	Distilled H <sub>2</sub> O (dH <sub>2</sub> O)	1 minute with agitation
4.	Richard-Allan Hematoxylin I	30 seconds with agitation
5.	Distilled H <sub>2</sub> O (dH <sub>2</sub> O)	15 seconds with agitation
6.	Distilled H <sub>2</sub> O (dH <sub>2</sub> O)	15 seconds with agitation
7.	Clarifier (0.025% glacial acetic acid)	30 seconds with agitation
8.	Distilled H <sub>2</sub> O (dH <sub>2</sub> O))	30 seconds with agitation
9.	Bluing Reagent (10mg LiCarb/1L)	30 seconds with agitation
10.	50% Reagent Alcohol	30 seconds with agitation
11.	95% Reagent Alcohol	30 seconds with agitation
12.	Richard-Allan Cytology Stain	1 minute with agitation
13.	95% Reagent Alcohol	30 seconds with agitation
14.	95% Reagent Alcohol	30 seconds with agitation
15.	100% Reagent Alcohol	30 seconds with agitation
16.	100% Reagent Alcohol	30 seconds with agitation
17.	100% Reagent Alcohol	30 seconds with agitation
18.	Xylene	1 minute with agitation
19.	Xylene	1 minute with agitation
20.	Xylene	3 minutes with agitation
21.	Mount per your laboratory's protocol	

\*Time may vary with laboratory preference.

# 10

## STAINING AND COVERSIPPING

### SECTION D

### COVERSLIPPING

Each laboratory should evaluate their choice of coverslip and mounting media to ensure compatibility with ThinPrep slides.

Hologic also recommends that 24 mm x 40 mm or 24 mm x 50 mm glass coverslips be used. Plastic coverslip material used with automated coverslipping instrumentation is also acceptable.

If you are staining and coverslipping for ThinPrep Imaging System slides, please see the Image Processor Operator's Manual first.





## Chapter Eleven

---

### ThinPrep Pap Test Training Program

#### SECTION A

#### OBJECTIVE

The ThinPrep Pap Test Training Program was developed by Hologic to assist laboratories in the conversion process from the conventional Pap smear to the ThinPrep Pap test. Hologic offers information, support and training for the conversion process, including communicating the change to the clinician, cytopreparatory training, ThinPrep Pap test morphology training and guidelines to assist with training the entire cytology staff in the laboratory.

#### SECTION B

#### DESIGN

Morphology Training is designed to communicate the differences between the conventional Pap smear and the ThinPrep Pap test. The participants use a series of slide modules to familiarize themselves with a spectrum of normal and abnormal cytological entities on ThinPrep Pap test samples.

This program is based on a cumulative learning process. Interpreting the morphologic criteria of ThinPrep Pap test samples requires review and application of cytology skills and knowledge. A systematic approach allows for frequent assessment of an individual's understanding of the ThinPrep characteristics. The training program incorporates both pre- and post-tests in order to assess learning progress.

The training begins with the ThinPrep morphology lecture, which is designed to familiarize the participants with the microscopic presentation of cervical samples prepared using the ThinPrep System. The format summarizes the morphologic features common to specific diagnostic entities described in *The Bethesda System for Reporting Cervical/Vaginal Cytologic Diagnoses*<sup>1</sup>.

Following the introductory lecture, a module of known ThinPrep Pap test cases are reviewed by all participants. This module presents a wide variety of diseases and disease states and provides the participant a base reference for the full range of the diagnostic categories to be encountered. Review of "look-alike" cases is also included. Through the use of the ThinPrep Gyn Morphology Atlas, which highlights common diagnostic entities and their differential diagnoses, participants will begin to recognize key look-alike entities on ThinPrep slides and the criteria that can be used in their proper classification.



## THINPREP PAP TEST TRAINING PROGRAM

A series of modules of unknown ThinPrep Pap test cases is used to assess the ThinPrep screening and interpretive skills of each participant. Participants are required to screen and diagnose each set of cases and record their results on the provided answer sheet. Once complete, the cases and correct responses are reviewed individually by each participant.

A final set of unknown ThinPrep Pap test slides is provided. This final set of slides is modeled after current CLIA guidelines and will be scored by Hologic-designated personnel. Successful completion of these slides is necessary to receive a certificate of completion.

CLIA Proficiency Test Program standards are used as guidelines in establishing pass/fail scoring criteria. Individuals receiving a 90% or better on the Final Assessment are qualified to screen/interpret ThinPrep Pap test cases, and to begin training additional cytotechnologists and pathologists in their laboratory under the supervision of the laboratory Technical Supervisor, if needed. Participants of the training program receiving less than 90% on the Final Assessment would require remedial training in their individual laboratories. This training involves the screening/diagnosing of an additional ThinPrep Pap test slide module provided by Hologic and requires a score of 90% or better to complete Hologic's ThinPrep Pap Test Training Program.

### **Cytology Staff Training**

Hologic supports cytology staff training by providing information and resources, such as slides, answer sheets, and online educational material, for use by the lab in training additional staff. The laboratory Technical Supervisor is ultimately responsible for ensuring adequate training for individuals prior to screening and interpreting ThinPrep Pap test cases.

## SECTION C

### BIBLIOGRAPHY

1. Nayar R, Wilbur DC. (eds). *The Bethesda System for Reporting Cervical Cytology: Definitions, Criteria, and Explanatory Notes*. 3rd ed. Cham, Switzerland: Springer: 2015

**Service Information**

**Service Information**

# Chapter Twelve

---

## Service Information

### **Corporate Address**

Hologic, Inc.  
250 Campus Drive  
Marlborough, MA 01752 USA

### **Business Hours**

Hologic's business hours are 8:30 a.m. to 5:30 p.m. EST Monday through Friday, excluding holidays.

### **Customer Service**

Product orders, which include standing orders, are placed through Customer Service by phone during business hours at 1-800-442-9892 Option 5 or 508-263-2900.

Orders can also be faxed to the attention of Customer Service at 508-229-2795.

### **Warranty**

A copy of Hologic's limited warranty and other terms and conditions of sale may be obtained by contacting Customer Service at the numbers listed above.

### **Technical Support**

For questions about ThinPrep® 5000 processor issues and related application issues, representatives from Technical Support are available by phone 7:00 a.m. to 7:00 p.m. EST Monday through Friday at 1-800-442-9892 Option 6 or 508-263-2900.

Service contracts can also be ordered through Technical Support.

### **Protocol for Returned Goods**

For returns on warranty-covered ThinPrep 5000 processor accessory and consumable items, contact Technical Support.

Service contracts can also be ordered through Technical Support.



## SERVICE INFORMATION

This page intentionally left blank.

Ordering Information

Ordering Information

# *Chapter Thirteen*

---

## Ordering Information

### **Mailing Address**

Hologic, Inc.  
250 Campus Drive  
Marlborough, MA 01752 USA

### **Remittance Address**

Hologic, Inc.  
PO Box 3009  
Boston, MA 02241-3009 USA

### **Business Hours**

Hologic's business hours are 8:30 a.m. to 5:30 p.m. EST Monday through Friday, excluding holidays.

### **Customer Service**

Product orders, which include standing orders, are placed through Customer Service by phone during business hours at 1-800-442-9892 Option 5 or 508-263-2900.

Orders can also be faxed to the attention of Customer Service at 508-229-2795.

### **Warranty**

A copy of Hologic's limited warranty and other terms and conditions of sale may be obtained by contacting Customer Service at the numbers listed above.

### **Protocol for Returned Goods**

For returns on warranty-covered ThinPrep® 5000 processor accessory and consumable items, contact Technical Support.



**Table 13.1: Supply Items for the ThinPrep 5000 Processor**

<b>Item</b>	<b>Description</b>	<b>Order Number</b>
Absorbent pad, filter plug	Package of 4 absorbent pads	71920-001
Absorbent pad, evaporation cover	Package of 4 absorbent pads	71921-001
Fixative bath	Bath container plus cover, package of 1	71917-001
Staining rack	Staining racks, case of 10	51873-001
Waste bottle	Waste bottle plus cap	70028-001
Input carousel	Package of 1 input carousel	ASY-11049
Dust cover	1 dust cover for input carousels	71918-001
ThinPrep 5000 Operator's Manual	1 replacement manual	MAN-06024-003
Vortexor	1 vortexor	*
15A/250V 3AB SLO-BLO fuses	Replacement fuses	53247-015

*\* Order number depends upon specific power requirements for each country. Contact Hologic Customer Service.*

**Table 13.2: Supplies for the ThinPrep Pap Test (Gynecologic) Application**

Item	Description	Order Number
ThinPrep Pap Test Kit	Materials for 500 ThinPrep Pap Tests <b>Contains:</b> 500 Vials of PreservCyt Solution for use with the ThinPrep Pap Test  500 ThinPrep Pap Test Filters (Clear)  500 ThinPrep Microscope Slides  500 Collection Devices  <b>Configured with:</b> 500 Broom-like Collection Devices  500 Cytobrush/Spatula Collection Devices	          70096-001          70096-003
ThinPrep Pap Test Kit (for use with the ThinPrep Imaging System)	Materials for 500 ThinPrep Pap Tests <b>Contains:</b> 500 Vials of PreservCyt Solution for use with the ThinPrep Pap Test  500 ThinPrep Pap Test Filters (Clear)  500 ThinPrep Imaging System Microscope Slides  500 Collection Devices  <b>Configured with:</b> 500 Broom-like Collection Devices  500 Cytobrush/Spatula Collection Devices	          70662-001          70662-003
ThinPrep Pap Test Physician Office Kit	<b>Contains:</b> 500 Vials of PreservCyt Solution for GYN  <b>Configured with:</b> 500 Broom-like Collection Devices  500 Cytobrush/Spatula Collection Devices	          70136-001          70136-002

**Table 13.2: Supplies for the ThinPrep Pap Test (Gynecologic) Application**

Item	Description	Order Number
ThinPrep Pap Test Laboratory Kit	<b>Contains:</b> 500 ThinPrep Pap Test Filters (Clear)  500 ThinPrep Microscope Slides	70137-001
ThinPrep Pap Test Laboratory Kit (for use with the ThinPrep Imaging System)	<b>Contains:</b> 500 ThinPrep Pap Test Filters (Clear)  500 ThinPrep Imaging System Microscope Slides	70664-001
Broom-Like Collection Devices Kit	<b>Contains:</b> 500 Broom-like Collection Devices (20 bags of 25 devices)	70101-001
Cytobrush/ Plastic Spatula Kit	<b>Contains:</b> 500 Cytobrush/Spatula Collection Devices (20 bags of 25 device pairs)	70124-001

**Table 13.3: Supplies and Solutions for Non-Gynecologic Applications**

Item	Description	Order Number
PreservCyt Solution	20 mL in a 2-oz. vial 50 vials/box	0234005
	946 mL in a 32-oz. bottle 4 bottles/box	0234004
CytoLyt Solution	946 mL in a 32-oz. bottle 4 bottles/box	0236004
	30 mL in a 50-mL centrifuge tube 80 tubes/box	0236080
	30 mL in a 120-mL cup 50 cups/box	0236050
Dispenser Pump	1 Pump for CytoLyt quart (32 oz.) bottle Dispenses approximately 30 mL.	50705-001
Non-Gyn Filters (Blue)	Box of 100	70205-001
ThinPrep UroCyte® System Kit	100 ThinPrep UroCyte filters (Yellow) 100 UroCyte microscope slides 2 PreservCyt vial 50-packs 4 bottles of CytoLyt Solution (946 mL in a 32-oz. bottle)	71003-001
ThinPrep UroCyte Filters (Yellow)	100 filters per tray	70472-001
ThinPrep UroCyte Microscope Slides	100 slides per box	70471-001
ThinPrep UroCyte PreservCyt Cups	50 cups per case	70991-001
ThinPrep UroCyte Urine Collection Kit	12 kits per case	70474-001
Arc-less slides (for IHC stains)	Box, 1/2 gross	70126-002



## ORDERING INFORMATION

This page intentionally left blank.





## Index

### A

- absorbent pad
  - evaporation cover 8.12, 13.2
  - filter plug 8.12, 13.2
- Administrative Options 6.16
- advanced processing options 6.5
- alert tones 6.24
- aliquot removal 7.19
- ancillary testing 7.19

### B

- barcode label format
  - slide 7.4
  - vial 7.3
- batch complete 6.12, 7.17
- batch processing errors 9.10
- baths 6.13, 7.9
- bleach 2.3
- bloody specimens (non-gyn) 5.23

### C

- carousel 7.8
  - ordering 13.2
  - sensor 8.4
- carousel sensors 8.4
- change fixative reagent 8.1
- clean screen 8.10
- clean system 8.2
- clear media 9.15
- clearances 1.10



## INDEX

- COBAS AMPLICOR™ CT/NG Test 7.19
- Collection
  - Broom-like device 4.3
  - broom-like device 13.4
  - Endocervical brush/Spatula device 4.4, 13.4
- collection media 5.4
- configure barcodes 6.28
  - accession ID 6.31
  - segment 6.37
  - test vial ID configuration 6.33
  - vial ID 6.29
- configure vial ID 6.29
- configure barcode
  - test settings 6.39
- coverslipping 10.4
- Customer Service 12.1, 13.1
- CytoLyt Solution 3.5, 13.5
  - composition 3.5
  - handling/disposal 3.6
  - packaging 3.5
  - stability 3.5
  - storage requirements 3.5
- CytoLyt Solution wash 5.12

## D

- date 6.19
- dimensions 1.10
- Disable Slide ID Match processing mode 6.5
- Disposal
  - consumables 1.17
  - instrument 1.18
- DiThioThreitol (DTT) procedure 5.16
- drip trays 8.13
- dust cover, carousel 7.8
- dust cover, ordering 13.2





## *E*

empty liquid waste tank 6.3, 8.6, 9.13  
Environmental 1.10

## *F*

filter waste bin 7.10  
fixation 10.1  
fixative bath status 6.13  
fixative bath, ordering 13.2  
fluid specimens  
    collection 5.3  
    preparation 5.17  
FNA specimens  
    collection 5.3  
    preparation 5.14  
fuse 1.11  
    ordering 13.2  
    replacing 8.14

## *G*

gather diagnostics 6.52  
glacial acetic acid 4.6, 5.23  
gynecologic sample preparation 4.1

## *H*

hazards 1.12

## *I*

installation 2.1  
Intended use (ThinPrep 5000 Processor) 1.2



## L

lab name 6.21

leak test 8.9

### Load

baths 6.14

carousel 7.8

filters, slides, vials 7.7

fixative bath 7.9

lubricant 4.2, 4.5

## M

### main screen

during processing 6.9

processor idle 6.2

maintenance schedule 8.15

### material safety data sheet

CytoLyt Solution 1.18

PreservCyt Solution 1.18

move bath to door 6.14

moving the processor 2.2

### mucoïd specimens

collection 5.3

preparation 5.15

Multiple Slide per Vial processing mode 6.7

## N

non-gyn filters 7.2, 13.5

non-gyn sample prep troubleshooting 5.22

non-gyn sample preparation 5.1

## O

OCR label format 7.5



operator's manual, ordering 13.2

## P

pads, absorbent 8.12  
pause a batch 6.10, 7.16  
power 1.11, 2.4  
power off 2.6  
power on 2.4  
power on self-test 1.12  
power switch 2.5  
PreservCyt Solution 3.1, 13.5  
    antimicrobial properties 3.3  
    composition 3.1  
    packaging 3.1  
    stability 3.2  
    storage requirements 3.1  
process sequence 6.4, 7.11  
processing complete 6.12, 7.17

## R

release filter 9.16  
release slide 9.17  
release vial 9.17  
remove baths 6.15  
reports and logs 6.42  
reprocessing protocol, gyn 4.6  
restart the system 9.18  
restricted mode 9.14

## S

safety data sheet  
    CytoLyt Solution 3.6  
    PreservCyt Solution 3.4



## INDEX

- sample is dilute 9.2
- sample processing errors 9.1
- save a report to USB key 6.48
- segment of ID 6.37
- serial number label 1.14
- shutdown
  - extended 2.6
  - normal 2.6
- slide ID format
  - 1-D barcode 6.36
  - 2-D barcode 6.36
  - barcode restrictions 6.34
  - OCR Non-Imager 6.34
  - OCR-Imager 6.34
- slide label
  - requirements 7.4
- slide label format
  - barcode position 7.5
- slide label format for Imaging 7.5
- sound 6.23
- specimen collection, gyn 4.3
- staining 10.2
- staining rack 7.9
- staining racks, ordering 13.2
- status indicators 6.3
- symbols used on the instrument 1.13
- system cleaning 8.2
- system error code 9.18
- system errors 9.14

## T

- Technical Support 12.1
- ThinPrep Pap Test 1.2
- ThinPrep Pap Test filters 7.2, 13.3
- ThinPrep Pap Test kit 13.3
- time 6.20



touch screen, cleaning 8.10  
troubleshooting 9.1

## U

unload  
    carousel 7.18  
    fixative bath 7.18  
UPS 2.1  
urine specimens  
    collection 5.4  
    preparation 5.17  
UroCyte collection kit 5.20  
UroCyte filters 7.2, 13.5  
UroCyte specimens 5.19  
usage details 6.51  
USB ports 2.5

## V

vial label  
    placement 7.4  
vial labels 7.3  
    barcode labels 7.3  
voltage 1.11

## W

Warnings, Cautions, Notes 1.12  
waste bottle 2.3, 8.6, 8.9  
waste bottle, ordering 13.2  
weight 1.10, 2.2



## INDEX

This page intentionally left blank.

# Labeling the Sample Vial

## ThinPrep® 5000 Processor

### Proper Labeling



Plastic over wrap is completely removed.



Barcode label: vertical, smooth, aligned with PreservCyt® Solution label

### Incorrect label placement

can cause a failure to read the barcode or a vial handling error.



**Do not...**

- place labels on the bottom of the vial
- place labels on the vial cap



**Avoid...**

- placing multiple labels on top of each other
- placing the barcode label over patient information
- wrinkles and peeling
- placing labels on the torque features of the vial



©2020 Hologic, Inc. All rights reserved. This guide is designed to be used in conjunction with, but not to replace, the ThinPrep® 5000 Processor Operator's Manual. As with all laboratory procedures, universal precautions should be followed. Prior to using the ThinPrep® 5000 Processor, the operator must be trained by Hologic personnel and be familiar with the full operating instructions, including any warnings, contraindications and safety information. Contact your local Hologic representative or, in Canada, call Technical Support at 1-800-442-9892.

# Setup Guide

## ThinPrep® 5000 Processor

### Load Alcohol Fixative Baths into the Instrument

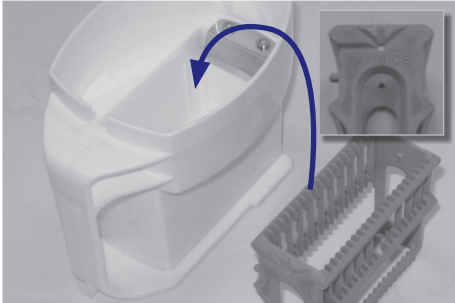

**Place...**  
the empty staining rack into empty fixative bath receptacle.  
On the rack, the words "UP SIDE" face the handle of the bath.



**Push...**  
the rack down past the point of slight resistance.  
Feel the rack snap into place.  
The rack must be fully seated.

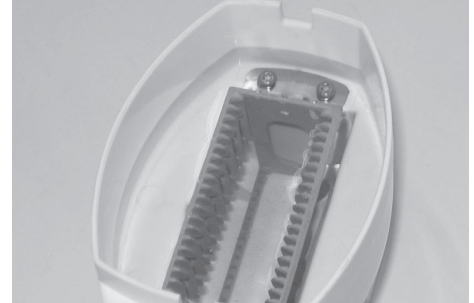

**Fill...**  
the bath with alcohol to the top of the staining rack.

### Empty the Filter Waste Bin

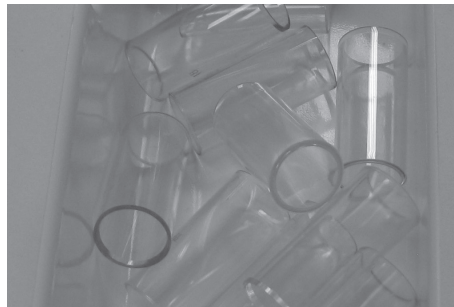
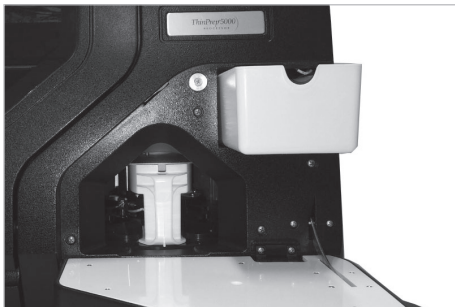

### Load the Carousel into the Processor



**Load filters...**open end up  
**Load vials and slides.** Slide labels face out.  
Vial and slide IDs match.

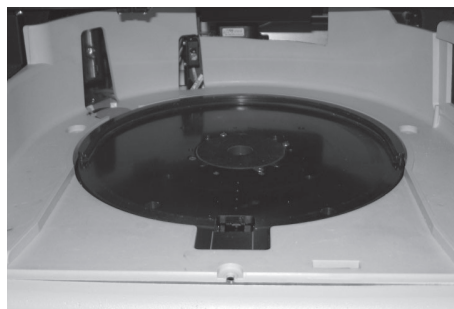

**Place...**  
the carousel flat, and slide it under the U-shaped collar, all the way to the rear wall.

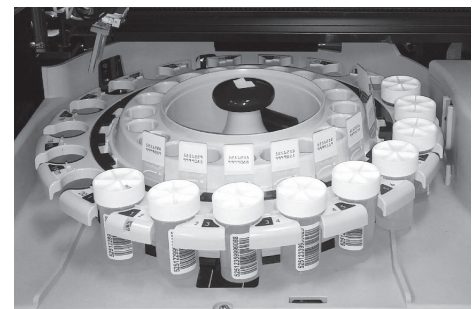

©2020 Hologic, Inc. All rights reserved. This guide is designed to be used in conjunction with, but not to replace, the ThinPrep® 5000 Processor Operator's Manual. As with all laboratory procedures, universal precautions should be followed. Prior to using the ThinPrep® 5000 Processor, the operator must be trained by Hologic personnel and be familiar with the full operating instructions, including any warnings, contraindications and safety information. Contact your local Hologic representative or, in Canada, call Technical Support at 1-800-442-9892.



# Maintenance

## ThinPrep® 5000 Processor

### Every Batch

Empty the filter waste bin

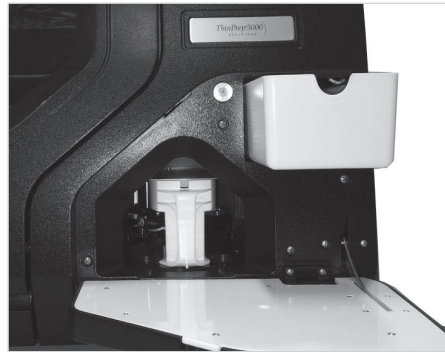

### Daily

Change fixative

Record maintenance activities

**ThinPrep® 5000 Processor Maintenance**

Maintenance Schedule for the Month/Year: *April 2014* Instrument # *T5-1*

	Daily or more	Weekly			As Needed				
	Change Fix Reagent every 100 slides or daily	Empty Filter & Slide Waste Bins	Clean Carousel, Dispersion Areas page 8.2	Clean Pneumatic Suction Holders page 8.3	Empty Waste Bottle page 8.4	Clean Touch Screen	Clean Carousel and Dust Cover	Change Absorbent Pads page 8.9	Remove and Clean Drip Trays page 8.10
1	AB 4.1.2014	AB 4.1.2014	AB 4.12014	AB 4.1.2014	AB 4.1.2014	AB	AB 4.1.2014		
2	AB 4.2.2014								
3	AB 4.3.2014								
4	AB 4.4.2014								
5	AB 4.5.2014								
6	AB 4.6.2014								
7	AB 4.7.2014							AB 4.7.2014	AB 4.7.2014

# Maintenance

## ThinPrep® 5000 Processor

### Weekly

**Clean around carousel and dispersion areas**

Lint-free towel and deionized water

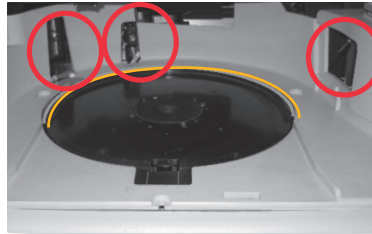

Carousel area



Dispersion area

**Clean around the filter plug and filter puncture area**

Cloth or swab and 70% isopropanol

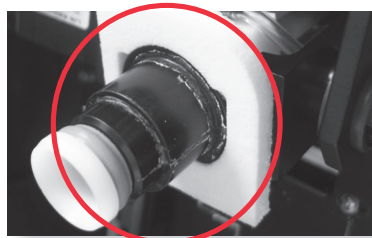

Filter plug

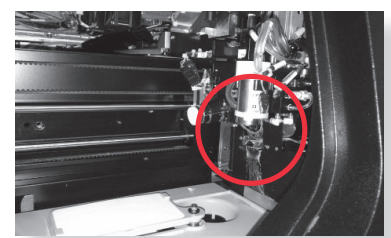

Filter puncture area

**Clean the slide holder pneumatic cups. Let dry.**

Lint-free towel and deionized water

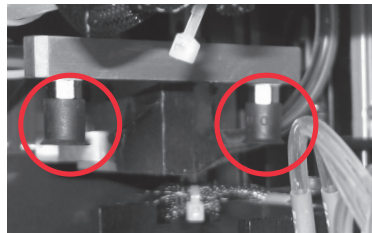

Processing area

### As Needed

Refer to the ThinPrep® 5000 Processor Operator's Manual for information on these additional maintenance activities:

- Emptying the waste bottle
- Cleaning the touch screen
- Cleaning the carousel and the dust cover
- Removing and cleaning the drip trays
- Changing the absorbent pads

# Error Recovery Guide

## ThinPrep® 5000 Processor

### Clear Media—Filters



**Move...**  
the filter transport arm, gently, toward the middle of the processing area for easier access.

Release Filter

**Press the button...**  
on the touch screen.

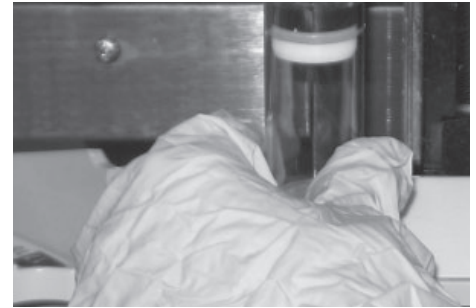

**Gently remove...**  
the filter off the filter plug.  
Do not use force.

or

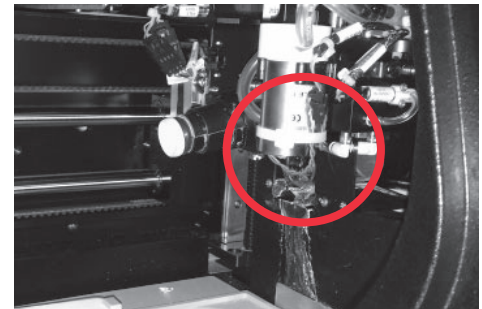

**Check...**  
the filter stripper bracket, and remove the filter, if present, from the filter stripper.

In most cases, following the “Clear Media” steps will resolve the error. If an error is persistent, contact your local Hologic representative with the complete error code. Report the complete error code because, for some errors, the first four digits represent the error category, and the remaining characters represent additional information about the mechanisms involved and their actions at the time of the error.

©2020 Hologic, Inc. All rights reserved. This guide is designed to be used in conjunction with, but not to replace, the ThinPrep® 5000 Processor Operator’s Manual. As with all laboratory procedures, universal precautions should be followed. Prior to using the ThinPrep® 5000 Processor, the operator must be trained by Hologic personnel and be familiar with the full operating instructions, including any warnings, contraindications and safety information. Contact your local Hologic representative or, in Canada, call Technical Support at 1-800-442-9892.

# Error Recovery Guide

## ThinPrep® 5000 Processor

### Clear Media—Vials

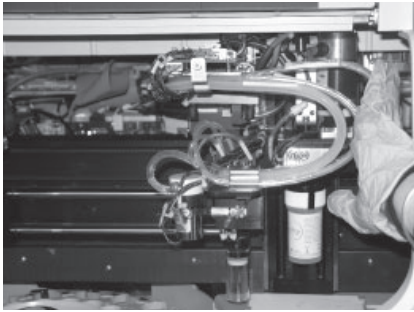

**Move...**  
the vial transport arm, gently, to the middle of the processing area for easier access.



**Hold...**  
cap and/or vial in the fingers of the vial gripper.

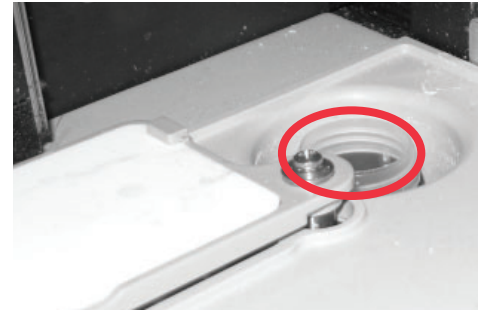

**Remove...**  
any vial from the dispersion well.



**Press the button...**  
on the touch screen and the cap will drop.

**Recap...**  
the vial manually.

### Clear Media—Slides



**Move...**  
the slide handling arm, gently, toward the middle of the processing area for easier access.

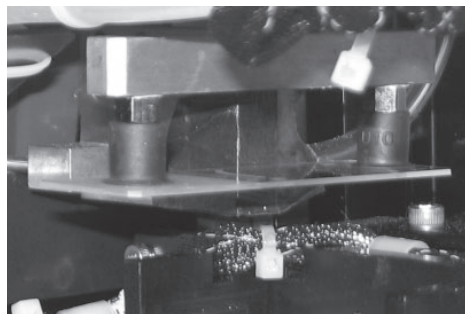

**Check two locations for a slide:**  
1. Slide holder cups  
2. Slide gripper fingers

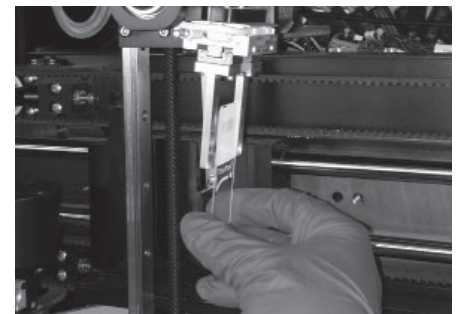

**Hold...**  
the slide so it does not fall.

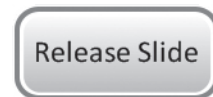

**Press the button...**  
on the touch screen and the slide will drop.

Each button on the Clear Media screen must be pressed before the message box will close.

# Hologic® ThinPrep® 50000 Processor Operator's Manual



Hologic, Inc.  
250 Campus Drive  
Marlborough, MA 01752 USA  
+1-508-263-2900  
[www.hologic.com](http://www.hologic.com)

MAN-06024-003 Rev. 002