



User Companion

Selenia[®]

Digital Mammography System

Selenia[®]

Digital Mammography System

User Companion

For Software Version 3.4

Part Number MAN-02621

Revision 001

May 2012

Technical Support:

USA: +1 877 371 4372

Europe: +32 2 711 4690

Asia: +852 37487700

All Other: +1 781 999 7750

HOLOGIC[®]

Corporate Headquarters

35 Crosby Drive,
Bedford, MA 01730-1401 USA
Tel: +1 781 999 7300
Sales: +1 781 999 7453
Fax: +1 781 280 0668
www.hologic.com

Europe (EU Representative)

Hologic NV
Leuvensesteenweg 250A
1800 Vilvoorde, Belgium
Tel: +32 2 711 4680
Fax: +32 2 725 2087



Refer to the corporate website for more facilities worldwide.

© Copyright Hologic 2012. All rights reserved. Printed in USA. This manual was originally written in English.

Hologic and the Hologic Logo are trademarks or registered trademarks of Hologic, Inc. Other trademarks registered or used by Hologic and its divisions and subsidiaries in the United States and other countries include: Affirm, Dimensions, DSM, FAST Paddle, HTC, MIMS, M-IV, MultiCare, SecurView, Selenia, Smart Paddle, StereoLoc, TechMate, and Trident. Solaris, Sun, Sun Blade, Sun Ultra, and Ultra are trademarks or registered trademarks of Sun Microsystems, Inc. in the United States and other countries. Microsoft and Windows are trademarks or registered trademarks of Microsoft Corporation in the United States and other countries. Any other product and company names mentioned herein are the trademarks or registered trademarks of their respective owners.

Table of Contents

List of Figures _____ **xi**

List of Tables _____ **xiv**

How to Start Up and Shut Down the System _____ **1**

1.0 Quick Reminder for System Startup in "Sleep" Mode 1
 2.0 Quick Reminder for System Startup when Completely Off 1
 3.0 How Should I Turn Off the System at the End of the Day? 1
 4.0 How Do I Turn the System Completely Off? 2
 5.0 How Do I Start Up the TechMate™ if It Is Turned Off? 2

Acquisition Workstation Q and A _____ **3**

1.0 How Can I Switch Users? 3
 2.0 What Are the AEC Modes I Have Available for Use? 3
 3.0 What Exactly is TEC (Tissue Exposure Control)? 3
 4.0 What Must I Know to Acquire Images on Patients with Implants? 4
 4.1 Method One—Imaging Patients with Implants Away From the Nipple 5
 4.2 Method Two—Imaging Patients with Implants Near the Nipple 6
 4.3 Method Three—Imaging Patients with Dense Tissue Next To the Implants 7
 4.4 Method Four—Imaging Implant Displaced Views 7
 4.5 How Should I Perform Implant Procedures? 8
 4.6 When I Print Implant Images, What Adjustments Might I Need to Make? 9
 5.0 Hints for a Localization Procedure 10
 6.0 What is the Recommended Exposure Technique for a Specimen? 10
 7.0 How Can I See Which Patients Are on the CD in the Drive? 11
 8.0 What Must I Do when I Get a Paddle Message? 11
 9.0 How Can I Send Images to an Output after the Procedure Is Completed? 12
 10.0 How Do I Edit the Patient Information on Selenia, and PACS? 13
 10.1 Correct the Information at the Acquisition Workstation 13
 10.2 Resend the Corrected Images to the Outputs 14
 11.0 What if I Reject an Image, but Then Change My Mind? 15
 11.1 Scenario #1 15
 11.2 Scenario #2 16
 11.3 Scenario #3 16
 12.0 What are the Quality Control Tests We Have to Perform? 17
 13.0 Quality Control Hints—Acquisition Workstation 17
 13.1 What Is the Best Way to Organize the Weekly Quality Control? 17
 13.2 How Can I Be Sure My Weekly Quality Control "Patient" Is Not Deleted? 17
 13.3 Can I Run the Repeat/Reject Analysis from an Office Computer? 18
 13.4 Can I Save Repeat/Reject Analysis as a Shortcut on a Computer's Desktop 18
 13.5 How Should I Empty the Reject Bin, and How Often Should I Do It? 19

13.6	Hints for the Flat Field Calibration Test	20
13.7	Hints for the Artifact Evaluation Test	21
13.8	Hints for the Phantom View and SNR/CNR Tests.....	21
The User Interface		23
1.0	Details about Login, Logout, and Shutdown	23
1.1	Startup Wait Time	23
1.2	System Messages	23
1.3	How to Log Out or Shut Down	24
1.4	Using the Emergency Off Switches.....	26
2.0	The Select a Patient Screen.....	27
3.0	Patient Demographic Database Organization.....	28
3.1	Available Databases	28
3.2	Available Patient Lists	29
3.3	The Acquisition Workstation Local Database	29
3.4	Acquisition Workstation Local Database and Modality Worklist Provider Interactions.....	30
4.0	Working with the Databases	30
4.1	Using the Bar Code Scanner.....	30
4.2	Querying the Modality Worklist Provider.....	31
4.3	Searching Local Exams—Acquisition Workstation Local Database.....	34
4.4	Searching Patient Data on a System Without a Worklist.....	37
5.0	Choose a Procedure	38
6.0	Patient View Screen	39
6.1	Patient View Screen Options	40
6.2	Selecting Exposure Modes	41
6.3	TEC Exposure Mode	42
6.4	AEC Exposure Mode.....	43
6.5	Select the Output	46
6.6	Implant Present - Patient View Screen	46
7.0	Acquiring Images.....	47
8.0	Working with Images	47
8.1	Preview Image	47
8.2	Comments	48
8.3	Implant Present.....	49
8.4	Zoom/Pan	49
8.5	ROI.....	50
8.6	Measurement	51
8.7	Magnification	51
8.8	Window/Level	52
8.9	Cropping.....	52
8.10	Accept or Reject Images	52
8.11	Accept a Rejected Image	53
9.0	Working with Images After They Are Accepted.....	56
9.1	Send the Images to the Output Devices	56
9.2	Patient View Screen with Thumbnails	57

9.3	Exposure Taken Using an Incorrect Icon	57
9.4	Close a Procedure.....	62
10.0	Additional Actions on the Patient View Screen	63
10.1	Add a View to the Procedure	63
10.2	Remove Unexposed Views Button	64
10.3	Edit Patients and Procedures	64
10.4	Non-Imaging Mode Button	67
10.5	Simulate Capture Button	69
10.6	Review Button	69
11.0	Clinical Procedures.....	69
11.1	Manual Mode	70
11.2	TEC Mode	71
11.3	AEC Mode.....	72
12.0	Performing a Screening Procedure.....	73
12.1	Select Patient, Procedure, Output, and Exposure Techniques	73
12.2	Set Up the Gantry	74
12.3	Position the Patient.....	74
12.4	Acquire the Image and Complete the Procedure	75
13.0	Working with Specimens.....	76
14.0	Performing a Localization Procedure	76
14.1	How to Use the Standard Crosshair Device.....	77
14.2	How to Use the Magnification Crosshair Device	78
15.0	Accepting and Storing the Image	78
16.0	Optional Workflow Operations	79
17.0	Main Menu Functions	79
17.1	Main Menu with No Selected Patient	79
17.2	File Menu>Exit	80
18.0	Edit Menu	80
18.1	Standard Setup Screens.....	80
18.2	Set Technique Defaults Screen	81
18.3	View Order Editor	81
18.4	User Setup— Add or Edit a User.....	82
18.5	Set Up Outputs.....	83
18.6	Data Storage (Using Outputs).....	88
19.0	Admin Menu	92
19.1	Image/Spool Management.....	92
19.2	Protect Patients.....	96
19.3	Manage Queues.....	97
19.4	Eject.....	100
19.5	Import.....	100
19.6	Retrieve Priors	102
19.7	MPPS Status.....	105
19.8	Test Patterns	106
19.9	Available Disk Space	107
20.0	Info Menu.....	107

System Hardware Details	109
1.0 System Power Controls	109
1.1 Acquisition Workstation Circuit Breaker	109
1.2 Gantry Circuit Breaker	110
1.3 Uninterruptible Power Supplies (UPS)	110
2.0 Controls and Displays	111
2.1 Compression Device Controls and Displays	111
2.2 Dual Function Footswitches	111
2.3 C-Arm Controls	112
3.0 Operator Radiation Shield	116
4.0 Background for the VOS Switch on the Mobile Selenia	116
The Manager Functions	117
1.0 User Identification	117
1.1 User Assignments	117
2.0 Main Menu Functions	118
3.0 Edit Menu—Mgr Level	120
3.1 View Order Editor	120
4.0 Admin Menu Functions—"mgr" User Level	121
4.1 Spool Management	122
4.2 Set Date and Time	128
4.3 Delete Patients	129
4.4 Reclaiming	130
4.5 Reject Management	131
4.6 Log Backup	136
4.7 Paddle Configuration	137
5.0 Info Main Menu Function	138
6.0 ALARM Function	138
7.0 Repeat/Reject Reports Options Available from the Browser	138
7.1 Administrative Reporting	138
7.2 Accessing the Report from Any Computer on the Network	139
7.3 Change Password	140
7.4 Reject Analysis Report	141
Troubleshooting	143
1.0 Alarm Types and System Messages	143
1.1 Category One Alarm Functions	144
1.2 Category Two Alarm Functions	147
1.3 Category Four Alarms	149
2.0 Tables of Messages and User Actions	149
2.1 Category One Alarms	149
2.2 Category Three Alarms	151
2.3 Category Two Alarms	152
2.4 System Message Information	161
3.0 Software Troubleshooting	163

4.0	Worklist Problems	165
4.1	Unknown RIS Code	165
4.2	Conflict Between Data in the Modality Worklist and Local Database.....	166
4.3	Resolving Patient Data Conflicts.....	167
Index	<hr/>	169

List of Figures

Figure 1: AEC Imaging Used for Breasts with the Implant Away From the Nipple.....	5
Figure 2: Implants Near the Nipple Require Manual Exposure Techniques	6
Figure 3: Image Implant Completely Displaced View with a Manual AEC Sensor Position	7
Figure 4: Image Implant Partially Displace View with a Manual AEC Sensor Position.....	7
Figure 5: Compression Release Set at Manual	10
Figure 6: The Review Button	15
Figure 7: Rejected Images	15
Figure 8: The Info Screen	20
Figure 9: Sign Out Button	24
Figure 10: Exit from Acquisition Station Dialog Box	24
Figure 11: Power Off the Computer Dialog Box.....	24
Figure 12: Confirm Exit from Program	25
Figure 13: Panel Power Dialog Box	26
Figure 14: Waiting for Link	27
Figure 15: Initial Select a Patient Screen with No Patient Information	27
Figure 16: Select a Patient Screen Options.....	28
Figure 17: Fields Used to Filter a Query to the Modality Worklist.....	31
Figure 18: Results of the Patient Query	32
Figure 19: List of Patients From the Today's Worklist Query	32
Figure 20: Selected Patients Appear in the Local Database, Local Exams Screen.....	34
Figure 21: Selecting an Existing Patient from a Search List	35
Figure 22: Typing a Patient Name in the Search Field.....	35
Figure 23: Select a Patient Screen.....	36
Figure 24: List is Too Long	36
Figure 25: No Patients Matching Query Message	37
Figure 26: Search for a Patient in a System Without a Worklist.....	37
Figure 27: Choose a Procedure	38
Figure 28: Patient View Screen Panes	39
Figure 29: Patient Views Options	40
Figure 30: Exposure Modes	41
Figure 31: Accepting TEC Techniques	42
Figure 32: TEC with Techniques Accepted	42
Figure 33: Override Mode	43
Figure 34: AEC Modes—Choices That Must be Made by the Technologist.....	43
Figure 35: AEC Exposure Adjustment Setting on Screen.....	45
Figure 36: No Outputs Warning	46
Figure 37: Image Preview Screen.....	47
Figure 38: The ROI Statistics Information on the Preview Screen	50
Figure 39: Changing the Window/Level Settings.....	52
Figure 40: The Accept Button.....	52
Figure 41: Review Dialog Box Showing Two Rejected Images.	54
Figure 42: Accept Rejected Image.....	55
Figure 43: Send Accepted Image to Outputs	55

Figure 44: Set Rejected Button.....	56
Figure 45: Send Accepted Image to Outputs.....	56
Figure 46: Patient View Showing Acquired Image	57
Figure 47: Patient View Screen’s Close Procedure button	62
Figure 48: A Finished Standard Screening Procedure	62
Figure 49: Patient Views Screen with Icon(s) for Scheduled Views.....	63
Figure 50: Results of Adding Another Procedure	65
Figure 51: Selecting Two Procedures in the Choose a Procedure Screen.....	66
Figure 52: Non-Imaging Mode Button.....	67
Figure 53: Non-Imaging Screen	68
Figure 54: Non-Imaging Dialog Box Warning	68
Figure 55: Rotate the Crosshair Device Out of the X-ray Field.....	77
Figure 56: Edit Menu	80
Figure 57: View Order Editor.....	81
Figure 58: Edit Users Dialog Box	82
Figure 59: Add a New User	82
Figure 60: Edit User Profile.....	82
Figure 61: Edit Outputs Dialog Box.....	84
Figure 62: New Output Name Dialog Box	84
Figure 63: New Name in Edit Outputs Dialog Box.....	85
Figure 64: Adding Devices	85
Figure 65: Configuring the Output Device(s)	86
Figure 66: Choose Output.....	88
Figure 67: No Output Selected	88
Figure 68: Invalid Media Alert.....	90
Figure 69: CD-R Alert.....	91
Figure 70: Admin Menu	92
Figure 71: Image Management Resend Options.....	93
Figure 72: Resend Confirmation	94
Figure 73: Repreview Screen	94
Figure 74: Protecting Patients.....	96
Figure 75: Protect Confirmation.....	96
Figure 76: Manage Queues Suspend Job Spooler button	98
Figure 77: Delete Selected Jobs in a Queue.....	99
Figure 78: The Import Dialog Box	100
Figure 79: Import Progress Dialog Box.....	101
Figure 80: Retrieve Priors Screen	103
Figure 81: Results of the Retrieve Priors Query.....	104
Figure 82: Image Import Started	104
Figure 83: Query Retrieve Import Successful Dialog Box	104
Figure 84: Search too Broad Dialog Box.....	105
Figure 85: Query Retrieve Errors dialog Box	105
Figure 86: Test Patterns Dialog Box.....	106
Figure 87: Image Queued Dialog Box	106
Figure 88: Acquisition Workstation Circuit Breaker	109

Figure 89: Gantry Circuit Breaker.....	110
Figure 90: Compression Device	111
Figure 91: The Dual Function Footswitch	111
Figure 92: AWS Radiation Shield	116
Figure 93: Value Console Radiation Shield	116
Figure 94: Edit Menu.....	120
Figure 95: View Order Editor.....	120
Figure 96: Admin Menu for the Mgr Logon	121
Figure 97: Choose a New Patient Dialog Box	122
Figure 98: Spool Management Window—One Image Selected.....	123
Figure 99: Repreview Window	125
Figure 100: Spool Management-Delete Image Function	127
Figure 101: Set Date/Time Option in Admin Menu	128
Figure 102: Date/Time Screen.....	128
Figure 103: Delete Patient Window.....	129
Figure 104: Patient Delete Error Dialog Box	129
Figure 105: Delete Selected Patients Dialog Box.....	129
Figure 106: Hard Drive Reclaimed	130
Figure 107: Hard Drive Full Alarm	131
Figure 108: Reject Management Window—(Resend is Shown)	131
Figure 109: Repreview Tab on Reject Management Screen	133
Figure 110: Reject Spool Full Alarm	134
Figure 111: Reject Management—Resend a Rejected Image.....	135
Figure 112: Log Backup—First Dialog Box	136
Figure 113: Log Backup—Second Dialog Box.....	136
Figure 114: Log Backup—Third Dialog Box	136
Figure 115: Log Backup—Fourth Dialog Box	137
Figure 116: Paddle Configuration Dialog Box	137
Figure 117: Info Screen.....	138
Figure 118: Log on to the Browser.....	139
Figure 119: Administrative Reporting Options	139
Figure 120: Change Password.....	140
Figure 121: Criteria for Reject Analysis	141
Figure 122: Location of Alarms by Type.....	143
Figure 123: Category One Alarm Dialog Box	144
Figure 124: AEC Error Message—Below Minimum	145
Figure 125: AEC Error Message—Above Maximum	146
Figure 126: Alarm Icon.....	147
Figure 127: Alarm Dialog Box.....	148
Figure 128: System Messages	149
Figure 129: Acquisition Workstation Circuit Breaker.....	163
Figure 130: Unknown RIS Code.....	165
Figure 131: Conflict Between the Worklist and Local Database.....	166
Figure 132: Sample Dialog Box: Add a New Procedure.....	166
Figure 133: Worklist Patient Conflict Dialog Box.....	167

List of Tables

Table 1: AEC Modes	3
Table 2: Exposure Techniques for Implants Near the Nipple.....	6
Table 3: Recommended Exposure Techniques for an Implant Near the Nipple.....	8
Table 4: AEC Mode— Available Selections.....	43
Table 5: Incorrect View Selection Changes.....	60
Table 6: Main Menu Functions with No Procedure Chosen.....	79
Table 7: Setup Choices.....	80
Table 8: Set Technique Default Choices.....	81
Table 9: Main Menu Functions by User (Patient/Procedure Not Selected).....	118
Table 10: Main Menu Functions by User (Patient/Procedure Selected)	118
Table 11: The Edit Menu for mgr Logon.....	120
Table 12: The Admin Menu for Mgr Logon	121
Table 13: Alarm Messages	149
Table 14: Image Processing Error Messages.....	151
Table 15: Category Two Alarms	152
Table 16: System Messages	161
Table 17: Software Troubleshooting.....	163

Chapter 1

How to Start Up and Shut Down the System

1.0 Quick Reminder for System Startup in "Sleep" Mode

1. Move the trackball to wake the system up.
2. In the Login dialog box enter reboot for the user name and password. Wait for the system to start up. The Logon dialog box appears.
3. Enter your Operating System user name *tech* or *mgr* (case sensitive).
4. Click the **OK** button or press the **Enter** key.
5. Enter the Operating System password (case sensitive) in the next dialog box.
6. Click the **OK** button or press the **Enter** key. Click the **Dismiss** button only if the system was in "Sleep" mode.
7. In the Login to System dialog box, click the down arrow and select your name in the list.
8. Click the Password field and enter your password (case sensitive).
9. Click the **OK** button or press the **Enter** key.

2.0 Quick Reminder for System Startup when Completely Off

1. Press the **On** button to start the system. The green LED Power On indicator illuminates.
2. Wait for the computer to start up. Do not click the Dismiss button in the Launch dialog box. Go to Step 3 above.

3.0 How Should I Turn Off the System at the End of the Day?

1. Click **File** (upper left of main screen), then select **Exit**.
2. Click the *Log out of the computer* option, and then click the **Yes** button.
3. Click the **Yes** button in the second "Exit from acq. station" dialog box. If a message appears that spool jobs are waiting, wait until the jobs are finished. The Logout Confirmation dialog box appears. It warns your current session will not be saved. Do not be concerned about this message.
4. Click the **OK** button. The OS Login dialog box appears. The unit enters a "Sleep" mode.

4.0 How Do I Turn the System Completely Off?

1. Click **File>Exit**.
2. Click the *Power off the computer* option.
3. Click **Yes**. If a message appears that spool jobs are waiting, wait until they are finished.
4. Click the **OK** button at the Logout Confirmation dialog box, "Are you sure you would like to power off the computer?" The green LED power indicator turns off.

5.0 How Do I Start Up the TechMate™ if It Is Turned Off?

1. To start up the TechMate, press the **power** button on the right side of the front cover.
2. Enter **scr** in the User name field, then click the **Return** button.
3. A "Technologist Workstation is loading" message appears.
4. The User login screen appears after the software loading is complete.

Chapter 2 Acquisition Workstation Q and A

1.0 How Can I Switch Users?

Click the **Sign Out** button. The Login to System dialog box appears.

The new user then selects their name from the Identify Yourself drop down list and enters their password. They are signed in.

2.0 What Are the AEC Modes I Have Available for Use?

There are three AEC modes: Auto-Time, Auto-kV, and Auto-Filter. These modes allow various levels of user control of the Automatic Exposure Control techniques:

Table 1: AEC Modes

AEC Mode	Filter Parameter	kV Parameter	mAs Parameter
Auto-Time	User selected	User selected	Determined from a scout exposure
Auto-kV	Filter is not selectable. Moly tube uses Mo filter. Tungsten tube uses Rh filter.	Determined from compression thickness and look-up table	Determined from a scout exposure
Auto-Filter	Determined from compression thickness and table	Determined from compression thickness and look-up table	Determined from a scout exposure

3.0 What Exactly is TEC (Tissue Exposure Control)?

Tissue exposure control (TEC) exposure mode is designed to take advantage of the imaging characteristics of the Selenia® FFDM system, which has significantly higher detective quantum efficiency and wider exposure latitude compared to a conventional screen-film mammography system.

When the TEC exposure mode is enabled, the Selenia system uses two parameters to compute the optimal x-ray exposure technique: (1) the compressed breast thickness, and (2) the estimated breast tissue density. The compressed breast thickness is automatically read by the Selenia compression paddle system. The mammography technologist estimates the breast tissue density, and sets the breast density control to one of the following three choices: FATTY, NORMAL, and DENSE. The computed x-ray exposure techniques (kV, filter, and mAs) are displayed on the Selenia acquisition display. Once the mammography technologist accepts the displayed exposure techniques, the Selenia system will change from STANDBY to READY, and an image can be acquired instantly.

TEC mode is an advanced MANUAL exposure mode. The mammography technologist always has the option to override the computed exposure techniques, simply by manually changing one of the exposure parameters (kV, mAs, or filter). After the computed exposure techniques are accepted or changed by the mammography technologist, the Selenia system no longer automatically re-calculates the exposure parameters. The TEC mode can be enabled again by changing the breast tissue density control, or by releasing and re-applying breast compression.

4.0 What Must I Know to Acquire Images on Patients with Implants?

The wide dynamic range of the digital detector on Selenia systems allows more flexibility in selecting techniques for imaging implants. However, image processing does not always produce optimal results. When all factors work together, digital images of implants contain more diagnostic information and are far superior to screen-film images.

Image processing on the system uses special algorithms to detect an implant on a digital mammogram. A key element contributing to the success of this algorithm is the use of correct exposure techniques. Although the digital detector may forgive mistakes in imaging techniques, the right exposure range is still necessary to acquire optimum images. The following sections provide guidance and recommendations to optimize the task of imaging patients with implants.

Compressing breast tissue that contains an implant is challenging to the technologist and the patient. Compression is important and adequate compression must be used when imaging patients with implants. Large variations of compressed thickness between the implant and the rest of the breast tissue may prevent image processing from correctly identifying the implant region.



Note

Always manually position the AEC Sensor when using AEC to image patients with implants. (If you use Auto AEC position, the system will place an AEC sensor under the densest portion of the breast; in a case with implants this will always be under the implant.)

4.1 **Method One—Imaging Patients with Implants Away From the Nipple**

The following figure demonstrates a breast with ample tissue in front of the implant. The Selenia AEC system may be used in this case to select the exposure techniques more accurately because there is enough breast tissue for AEC imaging. You can use the Auto-Filter mode and move the AEC sensor manually to the middle of the breast tissue area.

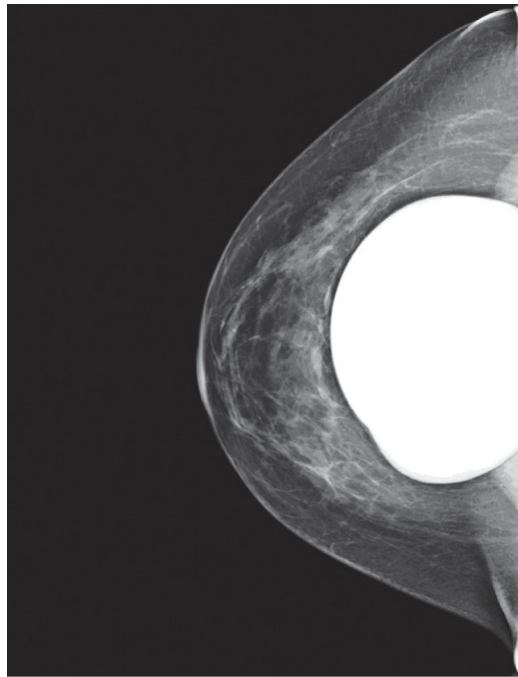

Figure 1: AEC Imaging Used for Breasts with the Implant Away From the Nipple

4.2 Method Two—Imaging Patients with Implants Near the Nipple

The next figure shows minimal breast tissue around the implant. When there is a small amount of breast tissue in front of the implant, the Selenia AEC can not be used accurately because there is not enough breast tissue to use AEC. Part of the implant can interfere with the AEC sensor. In this case use the Manual exposure techniques instead of AEC.

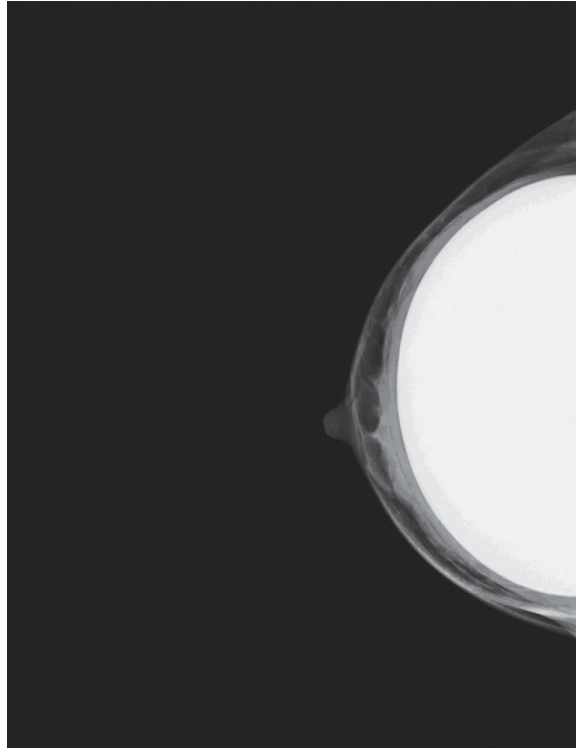

Figure 2: Implants Near the Nipple Require Manual Exposure Techniques

The two tables shown below provide the exposure techniques which apply to patients with implants that fall under this category. Do not use the exposure techniques in these tables to acquire images of patients without implants or to acquire implant displaced views. These exposure techniques were created only for imaging implants with minimal tissue around the implant.

Table 2: Exposure Techniques for Implants Near the Nipple

Selenia with Tungsten X-ray Tube			Selenia with Molybdenum X-ray Tube		
Thickness (cm)	kV	mAs	Thickness (cm)	kV	mAs
Less than 4 cm	28	100	Less than 4 cm	28	60
4 cm to < 6 cm	28	120	4 cm to < 6 cm	28	100
6 cm to < 8 cm	28	150	6 cm to < 8 cm	28	160
8 cm to 10 cm	28	150	8 cm to 10 cm	28	200
More than 10 cm	28	180	More than 10 cm	28	240

4.3 Method Three—Imaging Patients with Dense Tissue Next To the Implants

When a very dense area is next to the implant, the image processing can detect this dense area as an extension of the implant.

When a dense area next to the implant appears unexposed and part of the implant, the following actions can correct the condition and improve the image quality of the dense area:

- When you acquire the image of the implant with METHOD 1, switch to the Auto-Time AEC mode and increase the kV exposure technique by 2 kV. Adjust the manual position of the AEC sensor, if necessary.
- When you acquire the image of the implant with METHOD 2, keep the same mAs and increase the kV exposure technique by 2 kV.

4.4 Method Four—Imaging Implant Displaced Views

The figures below shows the implant completely or partly displaced from the imaging area. The Implant Displaced views are equivalent to normal views even though a small part of the implant remains visible in the image. Use the Selenia AEC (for example, Auto-Filter) to acquire these views. You should use a manual AEC sensor position to acquire implant displaced views to avoid interference from part of the implant still being present.

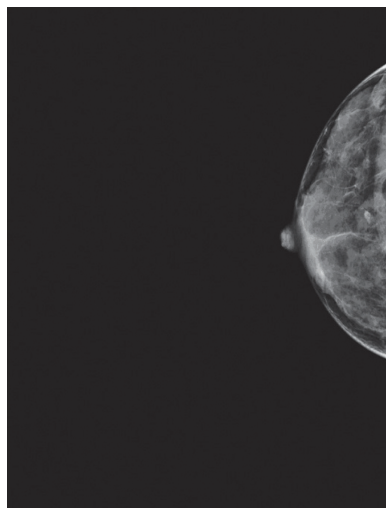

Figure 3: Image Implant Completely Displaced View with a Manual AEC Sensor Position

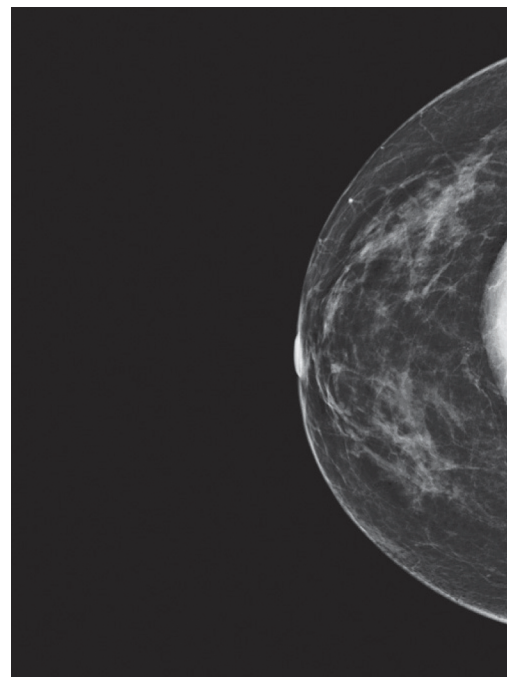

Figure 4: Image Implant Partially Displace View with a Manual AEC Sensor Position

4.5 How Should I Perform Implant Procedures?



Note

Never use AUTO AEC sensor mode when imaging implants. AUTO AEC mode puts an AEC sensor under the densest part of the breast. In a case with implants, this part is always under the implant. When imaging patients with implants with AEC, always use a manual position for the AEC Sensor location.

1. Select the **Screening Mammogram w/Implants** procedure from the drop-down list. Check the **Implant Present** box above the views. Leave this box checked for all views.
2. Position and compress the breast correctly for an augmented breast.
3. Acquire the full implant view:
 - a. *Method One*—If the implant is away from the nipple, use Auto-Filter and manually move the AEC Sensor to the middle of the breast tissue.
 - b. *Method Two*—If the implant is near the nipple, use a Manual exposure technique for the full implant view. Refer to the charts below for recommended exposure techniques to acquire an image of an implant near the nipple. The **Exposure Index** will be very low, but you do not need to be concerned. The exposure index is measured under the implant.

Table 3: Recommended Exposure Techniques for an Implant Near the Nipple

Selenia with Tungsten X-ray Tube			Selenia with Molybdenum X-ray Tube		
Thickness (cm)	kV	mAs	Thickness (cm)	kV	mAs
Less than 4 cm	28	100	Less than 4 cm	28	60
4 cm to < 6 cm	28	120	4 cm to < 6 cm	28	100
6 cm to < 8 cm	28	150	6 cm to < 8 cm	28	160
8 cm to 10 cm	28	150	8 cm to 10 cm	28	200
More than 10 cm	28	180	More than 10 cm	28	240

- c. *Method Three*—If the full implant preview includes a dense area next to the implant, re-acquire the image:
 - If you used Method One, switch to Auto-Time and increase kV by 2 kV. Adjust the manual sensor if necessary.
 - If you used Method Two, keep the same mAs and increase the kV by 2 kV.

4. Perform implant displaced views with AEC.
 - a. If the implant is in the field of view, place the photocell beyond the implant to avoid photo timing through the implant.
 - b. If the implant can be almost completely displaced from the imaging area, use Auto-Filter.
 - c. If a small part of the implant appears in the imaging area, use a manual sensor position.



Note

If you forget to check the **Implant Present** box on the Patient View screen, you may check the box on the Preview screen then click the **Reprocess Image** button at the bottom of the Preview screen.

4.6 When I Print Implant Images, What Adjustments Might I Need to Make?

Printed images of the full implants can appear flat or dark if sent to printer as a normal mammogram. The following adjustments may be required.

1. After the case is finished, select **Admin>Image/Spool Management**.
2. Find the case. Click all of the full implant views.
3. Click the **Resend selected image(s)** button.
4. Select your printer as the Output.
5. You can adjust the **Contrast/Density** for your printer. Change the contrast or density with the radio buttons. This change is only temporary for the images you are printing now.
6. Click the **Resend** button. A message appears which indicates how many images were resent.
7. Click the **OK** button.
8. Click the **Close** button when the printing is completed.

5.0 Hints for a Localization Procedure

The Localization procedure has additional steps not needed in other clinical procedures. See *Performing a Localization Procedure* on page 76 for the procedure.

- If a paddle other than the Localization paddle will be used, you must turn off the Automatic Compression Release. See *Standard Setup Screens* on page 80.

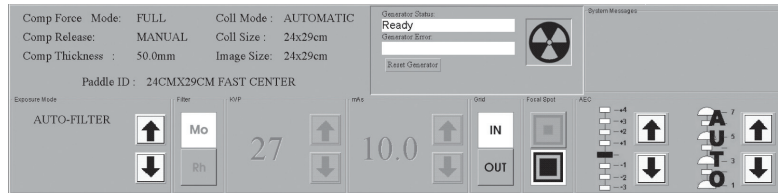

Figure 5: Compression Release Set at Manual

- After closing the Standard Setup window, confirm that Manual Release has been activated by checking the settings in the lower left hand part of screen.
- Upon completion of the Procedure, change the Compression Release back to automatic if this is the default. Confirm Automatic Release is activated by checking the settings.
- Remove the face shield.
- To add views, click the **Add View** button before you begin the exam. (Be aware, any additional view is automatically highlighted, so make sure you scroll back to the beginning of your procedure and highlight the first view).
- Take the scout image using Auto-Filter.
- Do not use Auto AEC position. Use manual position 2 or 3.
- If doing a magnification needle localization attach the magnification stand and magnification crosshairs.
- Remember to move the crosshair device or dial the crosshairs out of the field before you acquire the scout image.

6.0 What is the Recommended Exposure Technique for a Specimen?

Refer to the user manuals for the procedure.

- Position the specimen as close to the chest wall edge as possible.
- Always use a spot paddle.
- Use the magnification stand if desired.
- Take an exposure using the **Manual technique, 25 kVp, and 26 mAs.**

7.0 How Can I See Which Patients Are on the CD in the Drive?

Select **Admin>Import**, and the patient name is listed in the dialog box.



Note

The CD-RW is very sensitive. Do Not press the **Eject** button while the system reads from or writes to the disk.

Check Jobs in Queue to confirm no jobs are waiting to be sent before selecting **Eject** from the Admin menu.



Note

Do not use stick-on labels on a CD.

8.0 What Must I Do when I Get a Paddle Message?



This message appears if you have an incomplete paddle shift.

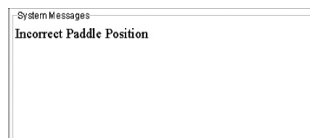

This message appears if your Smart Paddle™ is in the wrong position for the selected View.

The system will not acquire an image if the paddle is not installed in one of the three positions. The paddle position must match the selected View. Move the paddle to the correct position and the message clears.

9.0 How Can I Send Images to an Output after the Procedure Is Completed?

See the *Instructions for Use* for directions and *Send the Images to the Output Devices* on page 56 for additional details.



1. Click **Admin>Image (or Spool) Mgmt** and select the patient. All the thumbnails in that procedure will be displayed.
 - Click an individual thumbnail to see the available information regarding this particular view (displayed in the upper right portion of the window).
2. Click the **Resend** tab and either click the **Resend All Images** button, or select images and click the **Resend Selected Images** button.
3. Choose the Output from the drop down list.
4. Click the **Resend** button.

10.0 How Do I Edit the Patient Information on Selenia, and PACS?

- The best place to change the patient information is on the HIS/RIS before any information is sent to the Selenia. If the images are acquired and sent to the PACS, change the information at the PACS. Change Patient Information at the Selenia application as a last resort.



Note Some RIS systems eliminate the ability to change these errors at the Selenia.

- If the error involved exposing two patients under the same name, it may be necessary to read the first patient at the diagnostic review workstation, then delete the patient study before sending the second set of edited images, because of the information in the DICOM header.
- Because you can cause a mismatch of information when the Selenia images are sent to PACS, work with your HIS/RIS administrator before you make any changes to the patient information at the Selenia.
- You can only change the demographics for a procedure on the Acquisition Workstation. Demographics cannot be changed once the procedure is reclaimed.
- Be sure the incorrect images are still on the Acquisition Workstation before you delete them from the PACS.
- If incorrect images are already accepted and sent to Outputs, prior to sending corrected images you must:
 - At the SV:** Sign on to the SVDX as **delete** and delete that patient study.
 - At the PACS:** Contact your PACS Administrator and alert them to delete the incorrect study or advise another corrective measure.

10.1 Correct the Information at the Acquisition Workstation

These are some additional hints to change the information on the Patient View screen.

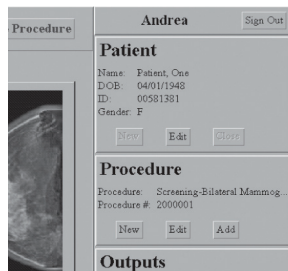

- In the Patient View screen under Patient (right side of screen) click the **Edit** button.
- If the Accession Number is also incorrect, click the **Edit** button under Procedure (right side middle of figure) and make the correction in that dialog box.
- Close the procedure.

10.2 Resend the Corrected Images to the Outputs

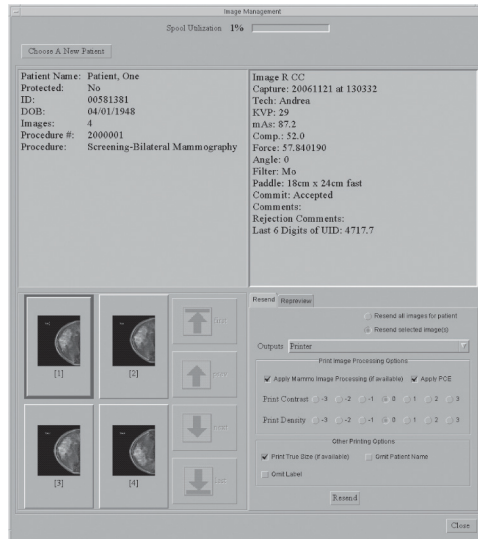

1. Click **Admin>Image (or Spool) Mgmt.**
2. Display the patient and click the **Repreview** tab.
3. Select and save each of the original images. (Follow the procedure in the *Instructions for Use.*) There should now be eight thumbnails (assuming there were four in the original study).
4. Click all of the last four thumbnails (these are the corrected views) and resend them. After you confirm that the new images have been sent, you may (at *mgr* level) go back into Spool Mgmt and delete the four images labeled incorrectly.

11.0 What if I Reject an Image, but Then Change My Mind?

11.1 Scenario #1

- The first image is taken and rejected.
 - The second image is taken and rejected (worse than the first).
 - You'd like to un-reject one of the images.
1. Click the **Review** button. A dialog box opens in the upper left of screen with tabs for all the views taken.

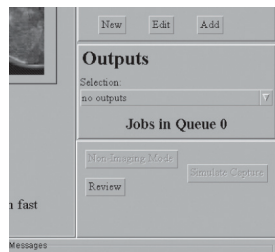

Figure 6: The Review Button

2. Click the Tab of interest [ex: RCC] to see all the rejected images for that view.

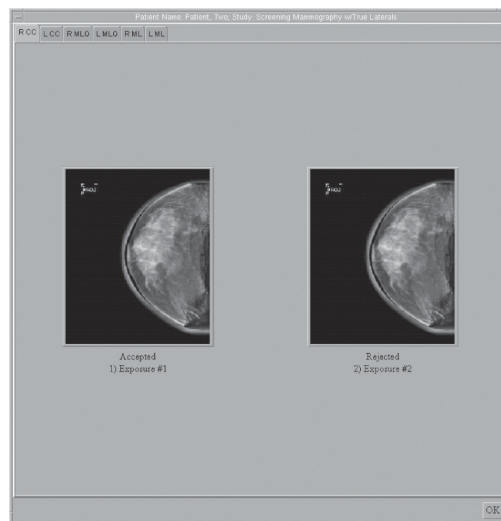

Figure 7: Rejected Images

3. Click the image that you want to Accept.
4. When the preview image appears, click the **Set Accepted** button.
5. To send to the selected Output, see instructions in Scenario #3.
6. Click the **OK** button to close the Review dialog box.

Only one Accepted image can be housed under one view icon at any one time.

11.2 Scenario #2

- The first image is taken and rejected.
 - The second image is taken and Accepted (sent to outputs when accepted).
 - You'd like to un-reject the first image and add it to the study.
1. Click the **Review** button (right side of screen, underneath Jobs in Queue, *figure The Review Button* on page 15). A dialog box opens in the upper left of screen with tabs for all the views taken.
 2. Click the Tab of interest [ex: RCC]. There are 2 images, 1 Rejected, 1 Accepted.
 3. Click the **Accepted** image.
 4. Wait for the preview image to appear, click the **Set Rejected** button.
 5. When the Image Rejection Information dialog box opens, check the appropriate reason.
 6. Click the **Reject** button.
 7. Now there are 2 rejected images. Click the first Rejected image.
 8. When the preview image appears, click the **Set Accepted** button.
 9. To send to the selected Output, see instructions in Scenario #3.
 10. Click the **OK** button to close the Review window.

11.3 Scenario #3



Note

Any image that was rejected prior to the Close Procedure are not sent to CAD. These images may be sent to CAD using the Scenario #3 instructions.

To use this method you must be signed in at the *mgr* level.

1. Click **Admin**.
2. Click **Reject Management**.
3. Click **Choose a New Patient**.
4. Select **Patient Name** tab, in the Patient Name field type in the patient's name. Click **Search**.
5. Select the patient.
6. Click the rejected images you want to send to an output.
7. Select **Resend**.
8. Click either **Resend All Images** for patient or **Resend Selected Images**.
9. Choose the Output from the drop down box.
10. Click **Resend**.
11. Click **Close**.

12.0 What are the Quality Control Tests We Have to Perform?

Refer to the current Selenia Quality Control Manual for the Quality Control Tests you must perform.

These tests, from the ACR Mammography Quality Control Manual, must still be performed:

- Visual Checklist
- Viewboxes and Viewing Conditions
- Compression Force

13.0 Quality Control Hints—Acquisition Workstation

13.1 What Is the Best Way to Organize the Weekly Quality Control?

Every month you should create a new "patient" for Weekly Quality Control.

1. Under Patient, click the **New** button.
2. For the patient info:
 - For the last name enter: WEEKLY Quality Control
 - For the first name enter: CURRENT MONTH (Jan, Feb, etc....)
 - For the ID, DOB, and Accession Number: Enter the current date (numbers only).



Note

If you have more than one Acquisition Workstation, you should add the room number to the patient ID field.

3. At the Procedure Description, choose **Tech Quality Control procedure** from the drop down menu.
4. Confirm **Weekly Quality Control** is the default.
5. Click the **Accept** button.

13.2 How Can I Be Sure My Weekly Quality Control "Patient" Is Not Deleted?

Make sure you Protect your Weekly Quality Control patient.

1. Select **Admin>Protect Patient**; search and select the current Weekly Quality Control patient.
2. Click the **Protect** button, and click the **Yes** button in the dialog box.
3. Click the **Close** button to close the Protect Patient dialog box.

13.3 Can I Run the Repeat/Reject Analysis from an Office Computer?

Setting up an office computer for Repeat/Reject Analysis

1. Get the IP Address of the Selenia system from Hologic™ personnel or your IT Group.
2. At the Office Computer, log on to the Internet Explorer or your internet provider.
3. Enter the web address:
Example: http://121.7.32.4.10:8080
http:// [the IP address]:8080)
4. Click the **Return** button.
5. The login screen displays.
6. Login with user name: admin (case sensitive, lower case).
7. Click the **Logon to the System** option. Click **Repeat/Reject**.
8. Select the To/From dates and select the technologist. Select the Type (Report).
9. Click **Submit**. The report is compiled.
10. Once the report finishes, click the **Print** button to print the report using the browser's print button.
11. Exit from the Browser when you are done to maintain security.

13.4 Can I Save Repeat/Reject Analysis as a Shortcut on a Computer's Desktop

1. Right click the login page, then, click **Favorites**. The computer prompts you for a link name.
2. Enter Selenia Repeat-Reject (and the Room # if there are multiple rooms).
3. Once the favorite is saved, click **My Favorites**.
4. Highlight the Selenia Repeat/Reject web link you just saved.
5. Right click to display the dialog box.
6. Click **Send To** and another dialog box displays.
7. Click **Desktop (create a shortcut)**. A shortcut to the Selenia Repeat/Reject Analysis Report displays on the computer's Desktop.

13.5 How Should I Empty the Reject Bin, and How Often Should I Do It?

Running the Reject report monthly gives the site better control, but it must be performed at least quarterly.

1. You must be signed on as mgr to perform this task.
2. Click **Admin>Reject Management**.
3. Click **Rejected Image Report**.
4. Click **Search**. If message displays, "There are too many results. Please refine your search," you must narrow the search:
 - a. Enter the Operator's (Technologist's) Name. This is their user name for the system, which may be their initials.
 - b. Click the **Search** button.
5. Click the first item in your Search Results.
6. Click the **Delete** Tab.
7. Click the **Delete All for Patient** button.
8. When Confirm Operation box appears, click the **Yes** button.
9. Click the **Rejected Image Report** button.
10. Click the **Search** button again.
11. Click the first item in your Search Results.
12. Follow step 7 to step 11 until you have deleted all rejected images.
13. If you entered the operator's name, you must enter the next operator's name and delete all of their images. Follow these steps until you have deleted all rejected images for all technologists.
14. Click the **Close** button (bottom right) to close the Choose an Operator dialog box.
15. Click the **Close** button (bottom right) to close the Reject Management dialog box.

13.6 Hints for the Flat Field Calibration Test



Note

Clean the detector and acrylic block before Calibration.



Figure 8: The Info Screen

1. Follow Instructions printed on the screen.
2. To check the Detector Temperature, click **Info>About the Acquisition Station**.
3. On the left side of the Info screen, midway down, look for Temperature. This is the current detector temperature.
4. If the current detector temperature is not within normal temperature range, between 20 and 37 degrees Celsius, delay the calibration test until it is within normal temperature.



Note

If you do this test in the middle of the day, wait at least 30 minutes after the last patient to start the calibration procedure.

5. Click **OK** to close the screen.

13.7 Hints for the Artifact Evaluation Test

- Select the weekly QC patient and for Outputs select QC Artifact Evaluation.
- Put a CD in the CDRW drive if you store your QC on a CD.
- To use the Zoom/Pan, either hold down the right button and move the trackball/mouse or hold down the left button when the cursor is in the thumbnail and move the trackball/mouse.

13.8 Hints for the Phantom View and SNR/CNR Tests.

- For Outputs, select QC Phantom.
- If there is an **SNR** button, these are calculated for you automatically.
- If there is no **SNR** button, use the logs and worksheets in the QC manual to record your values and calculate your results, then record them on the QC forms from the Quality Control manual.

Chapter 3

The User Interface

This chapter contains additional information about the User Interface available to all users. The first part is organized in the order you might use the system. The next part has suggestions and hints for clinical procedures. The last part has details about using the menu functions and additional information about functions available on the screens.

1.0 Details about Login, Logout, and Shutdown

When the system is started, the computer performs internal startup tests. If the system detects a fault condition during the internal checks, a message displays and startup is suspended until the problem is remedied. When the startup tests are complete, the Sun Operating System login dialog box is displayed.

Users must log in to the Sun Operating System and to the Selenia Application software separately.

1.1 Startup Wait Time

After login into the Operating system, the application starts and a **Launch** dialog box alerts you that the digital detector is warming up and to wait before starting any clinical procedures. The alert does not restrict use of the system before the warm-up time expires.

The temperature of the Selenia Detector is critical for image quality. To stabilize its temperature, the detector should be on for at least 1 hour (warm up) before patient exposure.

- If the system has been off longer than 30 minutes, wait until the message no longer displays before acquiring images for clinical purposes.
- If the system has not been off longer than 30 minutes, click **Dismiss**.

1.2 System Messages

The System Message area displays system status and communication between the detector and the Acquisition Workstation (AWS). The displays in the message area are very important when restarting the system after using one of the Emergency Stop Switches (discussed later in this chapter.)



Note

When the application starts, the system evaluates the last calibration date. If the date exceeds the calibration period, an error message appears and use of the unit is restricted until it is calibrated. No patient procedures can be performed. Refer to the **QC Manual** for Calibration procedures.

1.3 How to Log Out or Shut Down

You can exit the software application to log out, change users, or shut the system down. The dialog box for changing users is available as a button on the main application screen or from the File Menu (**File > Exit**).



Figure 9: Sign Out Button

This **File>Exit** dialog box presents options for shutting down or restarting the system, logging out of the Application, or changing users. Select the option you want and click **Yes**. Click **No** to close the dialog box and remain signed on. The options are discussed in the sections that follow.

After making your selection, follow the on-screen prompts.

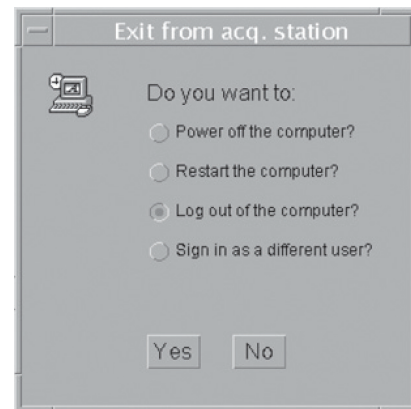

Figure 10: Exit from Acquisition Station Dialog Box

1.3.1 Power off the Computer

This option shuts down the system.

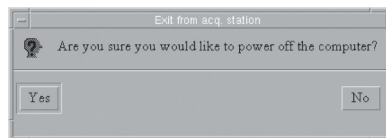

Figure 11: Power Off the Computer Dialog Box

An additional dialog box asks if you are sure you want to power off the computer. Click **Yes** or **No**. To restart the shutdown system, press the Acquisition Workstation **On** button.



Caution:

Do not use a circuit breaker or Emergency Off switch as a routine method to turn off the Selenia.



Caution:

Never turn off the Acquisition Workstation or Value Console Circuit Breaker except in emergency. The circuit breaker can turn off the Uninterruptible Power Supply (UPS) and risk data loss.

1.3.2 Restart the Computer

This option reboots the system. After the reboot you must log on to the OS and Acquisition Workstation software. Use this selection for troubleshooting purposes.

1.3.3 Log Out of the Computer

This option exits the Acquisition Workstation application and the OS.

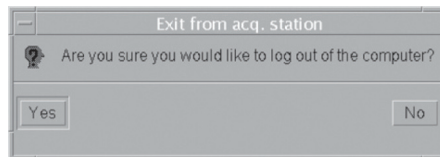

Figure 12: Confirm Exit from Program

A dialog box questions if you want to continue to log out of the Acquisition Workstation. After you log out, you can shut down the computer, or a new user can log in at a different user level. The next user must log on to the OS first, then the Acquisition Workstation software.

Use this at night to allow auto shutdown/startup. In the morning, log in by typing reboot for the user name and password. When the system restarts, log in normally.



Note

Reboot the Acquisition Workstation's computer daily to resync system communication.



Note

If a message appears that spool jobs are waiting, choose if you want to go ahead and log off or wait until the jobs are finished. (The spool picks up again later.) Hologic strongly suggests allowing the jobs to complete before shutting down.

1.3.4 Sign In as a Different User

This option signs out the current technologist without changing the OS logon. A new technologist signs in with the same OS access level. This works the same way as clicking the Sign Out button.

1.4 Using the Emergency Off Switches

There are three Emergency Off switches on the Selenia, one on either side of the Gantry and one on the Acquisition Workstation. Do not use the Emergency Off switches for routinely turning off Selenia. They only affect the Gantry and should be used only in an emergency.

1.4.1 Use the Emergency Off Switch

1. Press any Emergency Off switch. The power to the Gantry is immediately removed.
2. If the emergency occurred during a Patient Exam and the patient is compressed, use the handwheels to manually release the patient.

1.4.2 Restart the System After Activating the Switch

1. Turn the Emergency Off switch one-quarter turn clockwise.
2. When the Power Panel dialog box displays, "**Communication with the generator is lost**," examine the Emergency Off Switches and the circuit breaker.



Caution:

Do not close this dialog box by using the X in the upper corner.

3. Click **Cancel** if the Gantry is already on.
4. If the Gantry is off, and the Emergency Off Switches and the circuit breaker are set correctly, click **OK** to restart the Gantry.
5. Click **OK** again when the "**Link established with generator**" dialog box appears.

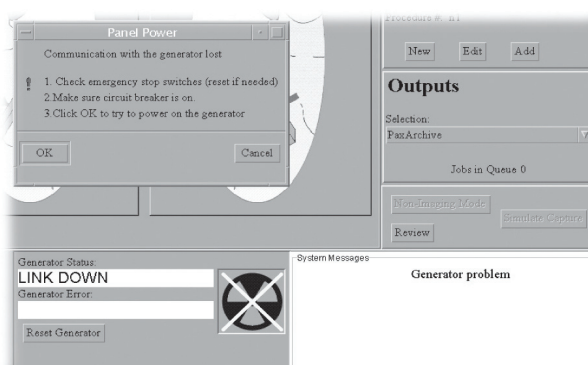

Figure 13: Panel Power Dialog Box

If the dialog box reappears:

1. Observe the Gantry status before you respond to the Panel Power dialog box.
2. If the Gantry displays are *On*, click **Cancel**.
3. If they are *Off*, click **OK**.
4. After you click **OK**, a new dialog box, "**Waiting for link to be established with generator**," is displayed.



Caution:

Do not close this dialog box by using the X in the upper corner.

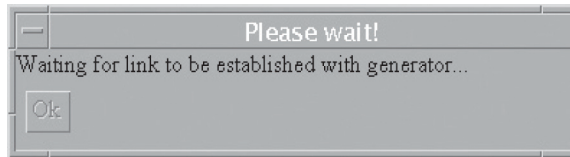

Figure 14: Waiting for Link

5. Once a link is established, the message changes to "Link established with generator" and an OK button is enabled.
6. Select OK as soon as this is enabled.



Note

It may be necessary to click Reset Generator after clicking OK if the Generator Problem message isn't cleared.

2.0 The Select a Patient Screen

This screen appears when the application first loads.

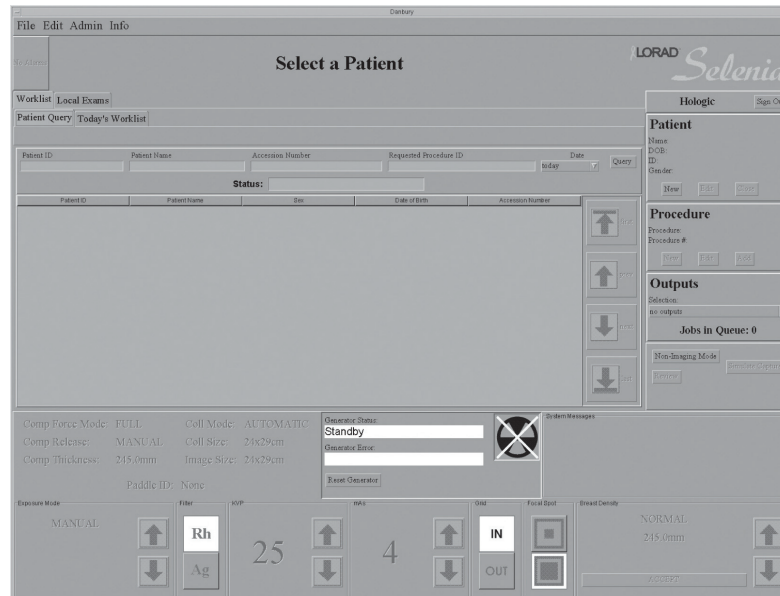

Figure 15: Initial Select a Patient Screen with No Patient Information

This chart diagrams the choices available on the Select a Patient screen.

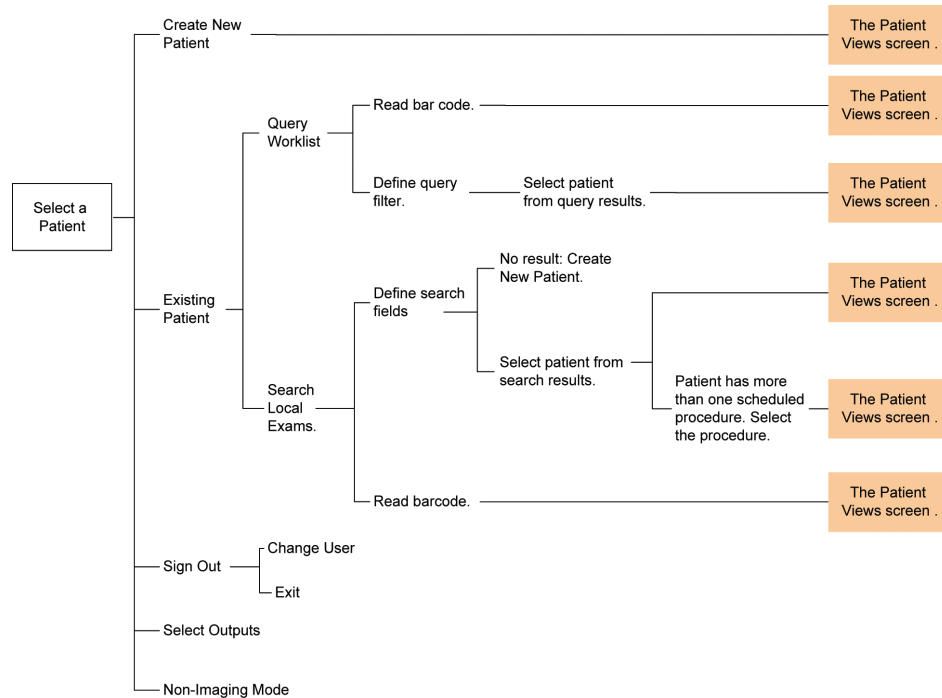

Figure 16: Select a Patient Screen Options

The screen enables you to select a patient from existing databases or create a new patient. This section covers additional details about working with the system databases.

3.0 Patient Demographic Database Organization

3.1 Available Databases

The Selenia Acquisition Workstation has a local database on the workstation computer that stores the patient and image data. The Selenia system also can be configured to have a network connection to a Modality Worklist Provider. This provider can be queried for scheduled patients and their procedures. This process creates a Modality Worklist. Selecting patients from the worklist adds them to the local database.

The Selenia can be configured to communicate with other systems over a network or as an independent unit. When connected to a network, Selenia can query a Modality Worklist Provider, such as a RIS (Radiology Information System) or PACS, for a list of scheduled patients, and the Local Exams (the local database stored on the Acquisition Workstation’s computer).



Note

The Modality Worklist is a list of scheduled exams, typically maintained by a RIS (Radiology Information System) or PACS. For the Modality Worklist to be operational, this feature must be installed and configured for your specific Modality Worklist Provider.

When Selenia is not connected to a Modality Worklist Provider, the local database can be queried for local exams. If your system is not connected to any PACS or RIS system, there are not any Worklist or Local Exams tabs.

3.2 Available Patient Lists

Selenia can display the following types of patient lists:

1. A list of patients resulting from an "On Demand" query to a Modality Worklist Provider (RIS or PACS).
2. A list of patients in the local database. This list includes:
 - Local Exams.
 - Patients entered locally using the **New Patient** button. These patients include completed and uncompleted exams.
 - Uncompleted patient exams that were originally part of a query to a Modality Worklist Provider.

3.3 The Acquisition Workstation Local Database

The local database provides an automatic means to identify patients and temporarily store information about acquired studies so that the output from the Acquisition Workstation is as accurate and complete as possible.

Patient identification involves three functions of the Acquisition Workstation:

- Acquiring Patient demographic information
- Storing Patient demographic information in a local database
- Identifying the Patient and associating the correct demographic information with that Patient upon examination

3.4 Acquisition Workstation Local Database and Modality Worklist Provider Interactions

When the system is configured with a Modality Worklist Provider (MWP), which is typically part of a RIS or a PACS, Patient Demographic information may be obtained from it. There are three basic interactions between the Acquisition Workstation and the Modality Worklist (MWL SCP) functionality:

- **Local Worklist:** The purpose of the Local Worklist is to cache the worklist items obtained from the MWL by the query function. It represents a snapshot of the MWL SCP's worklist obtained by the MWL query. The Local Worklist is distinct from the Local Database, and may contain information that is not included in the Acquisition Workstation information for a given Patient.
- **Local Database:** The Acquisition Workstation maintains its local database with the sole purpose of completely and correctly identifying acquired images. The Local Database is updated from a worklist item when a worklist record is selected.
- **Synchronization:** The Acquisition Workstation synchronizes the Local Worklist and the Local Database when you select a worklist item(s). At Synchronization time, if the information from the selected worklist is found to be inconsistent with the local database, you are given the option of resolving the inconsistencies via a dialog box showing both Local and Worklist data. Inconsistencies are not resolved automatically.

For help with Worklist Problems, see *Worklist Problems* on page 165.

4.0 Working with the Databases

4.1 Using the Bar Code Scanner

The Acquisition Workstation supports a single bar code scanner that identifies a Patient already in the Worklist or the local database. Scanning a barcode automatically generates a query to match the Patient ID or Accession Number (whichever is configured). It queries whichever database is selected before the barcode is scanned.

4.2 Querying the Modality Worklist Provider

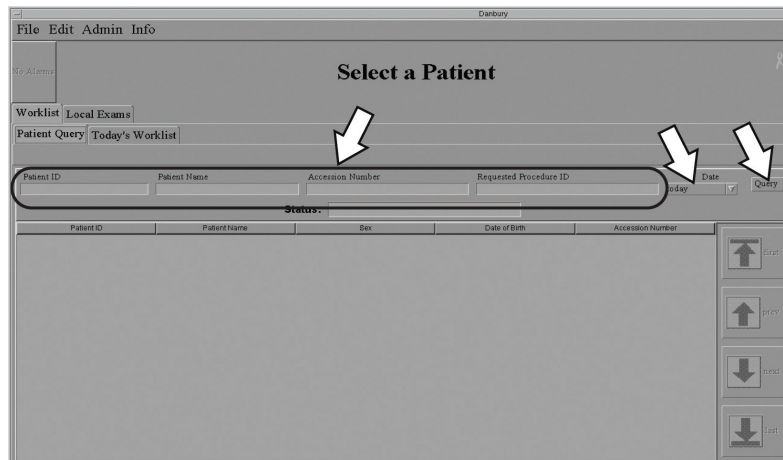

Figure 17: Fields Used to Filter a Query to the Modality Worklist

To query for a Patient from the Modality Worklist Provider:

1. Click the **Worklist** tab.
2. To input the query information:
 - a. Bar Code Scanner—scan the patient ID barcode. The patient’s scheduled procedure displays and the patient is added to the local database.
 - b. Keyboard—one or more fields may be used to query the Modality Worklist Provider. Enter the information and click **Query** or press **Enter**. The search results display on the screen.

A sample query for a patient scheduled for today’s date (enter into the appropriate field):

- The patient’s name:
- Patient ID:
- Accession Number:
- Requested Procedure ID:
- From the Date drop-down menu select **today**.

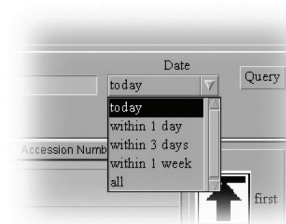



Figure 18: Results of the Patient Query

- If you changed the date from the 'today' default, you can click **Today's Worklist** tab to display today's appointments.
- The Patients who are scheduled for today and meet the criteria you specified display on the screen.

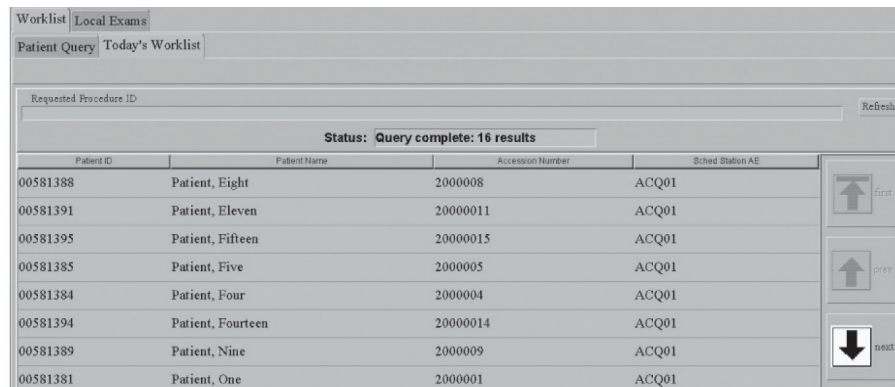
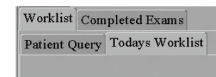

Figure 19: List of Patients From the Today's Worklist Query

3. Select the patient to open their procedure.
4. If your search for a single match with a patient ID or Accession Number is successful, the patient's Procedure opens automatically.

4.2.1 Additional Query Information and Hints

- Typing partial information for the patient name assumes a wildcard character at the end of the name.



Note

You can use the asterisk (*) character as a wildcard character to broaden your search. For example, entering R*ph would display Patients named Randolph and Rudolph. If you are using the wildcard character, make sure you include at least one other character (that is, don't enter only an asterisk) to avoid listing all Patients or Procedures, which might take several minutes to complete.

- One or multiple fields may be used as search criteria.
- You can enter a partial name and press Enter on the keyboard to initiate the search (no need to click the **Query** button).
- Limit the query to a date range using the today drop-down field and selecting a date range.
- Most Worklist Providers require exact matching on Patient ID and Accession Number fields and are case sensitive.
- Names are stored in the database as LAST^FIRST^MIDDLE. You must include the caret (^) character between the name parts (for example, DOE^J).

4.2.2 Using the Patient Query feature

The resulting list displays Patients who met the criteria. The number of results is in the Query pane and the data appear in the **Patient List**. To scroll through a list longer than one screen, use the arrows on the right of the screen. Depending on the criteria you selected, patients who are not scheduled for today may be in this list.

4.2.3 Querying Modality Worklist Connections

In sites with a Modality Worklist Provider, select the **Worklist** tab (if it is not already highlighted) to query the MWP.

4.2.4 Using the Today's Worklist Feature

If you did not use the 'today' date query, you can list the appointments for today by clicking on the **Today's Worklist** tab. (If you used the 'today' date query, the results are the same.)

Click the Patient name in the list to add their data to the local database (Local Exams) and open their procedure.

4.3 Searching Local Exams—Acquisition Workstation Local Database

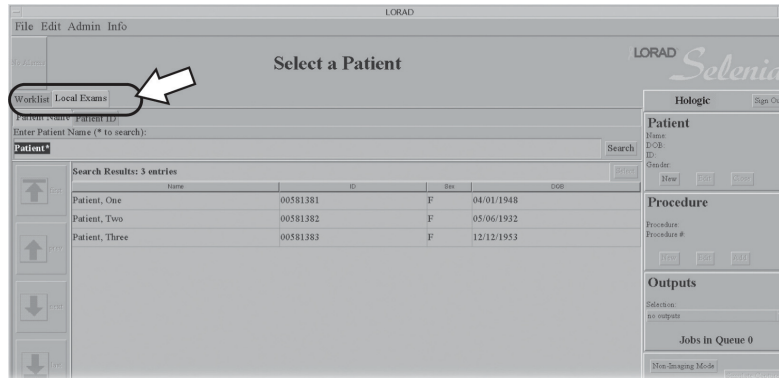

Figure 20: Selected Patients Appear in the Local Database, Local Exams Screen

Patients and related information are kept temporarily, storage space availability permitting, in the local database to save having to re-enter information for a recently x-rayed Patient.

4.3.1 How Patients are Added to the Local Database

The Acquisition Workstation Local Database acquires a Patient/exam entry by:

- **Manual Creation:** Creating a new Patient/exam at the Acquisition Workstation.
- **Modality Worklist:** The selection of a worklist item from a list of items obtained by querying a DICOM Modality Worklist Service Class Provider (MWL SCP).

4.3.2 Search the Local Exams

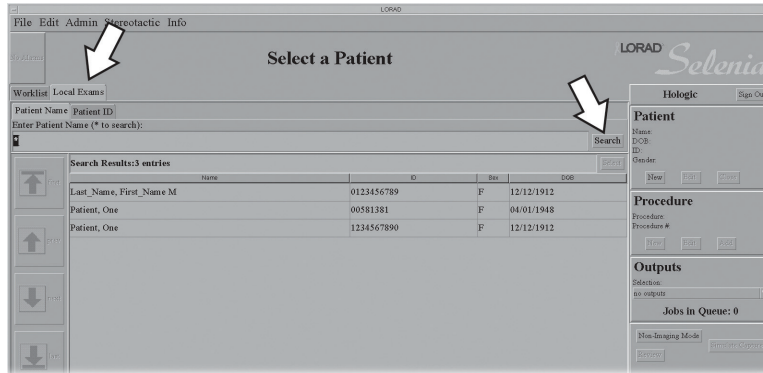

Figure 21: Selecting an Existing Patient from a Search List

- To search for a Patient in the Local database:
 - Click the **Patient Name** or **ID** tab. Enter the Name or ID in the Search box and either click **Search** or press **Enter**.
 - Enter part of a name or ID number and click **Search**. If you are not typing the first part of the ID, you must put an asterisk in the beginning of the name or ID to stand for the part that you did not enter.

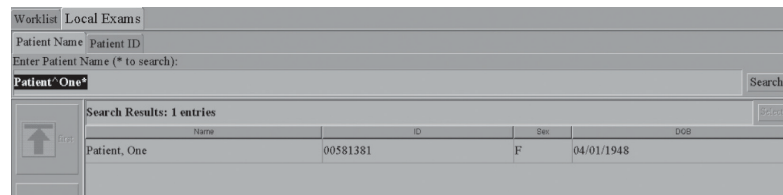

Figure 22: Typing a Patient Name in the Search Field

The system searches its local database for the Patient or Procedure ID and displays the list of patients matching the search criteria.

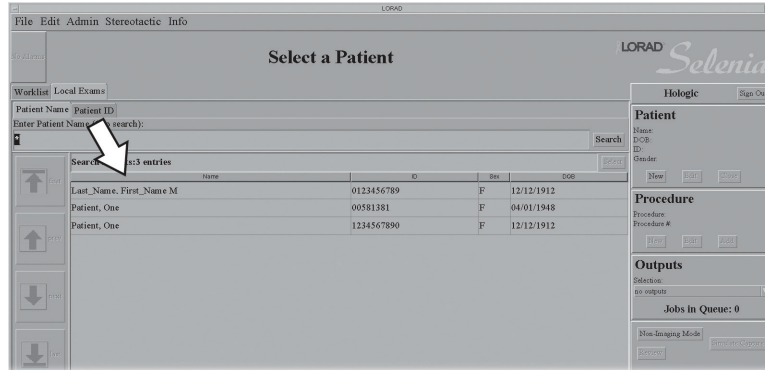

Figure 23: Select a Patient Screen

2. Select the Patient in the list:
 - Their procedure opens in the Patient Views screen.
 - If the Patient has more than one Procedure scheduled, the Choose a Procedure Screen displays with a list of their procedures.

4.3.3 If the List Is Too Long

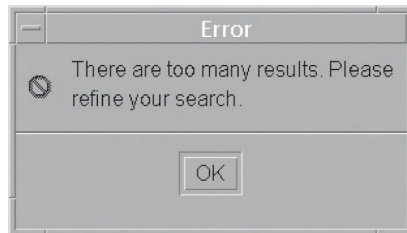

Figure 24: List is Too Long

If your results give a very long list, you may get an error message. Include more of the name or ID number and try searching again. If the list is long, you can search for an exact name or Patient ID.

1. Select the appropriate tab.
2. Enter a name, or partial name or partial ID in the field to the left of the **Search** button.
3. Click **Search**. The resulting list contains only those Patients that meet the requested criteria.
4. Select the Patient you want from the shorter list.

4.3.4 Guidelines for Entering Names in a Search

Note the following guidelines when entering names:

- Names are stored in the database as LAST^FIRST^MIDDLE. You must include the caret (^) character between the name parts (for example, DOE^J*).
- Because names are stored in the format LAST^FIRST^MIDDLE, to search for the first name Jane you must use an asterisk (for example, *Jane).
- Search entries are not case sensitive; you can enter upper or lower case letters.

4.3.5 Patient Not Found

If there is no match, the No Patients Matching Query dialog box appears.

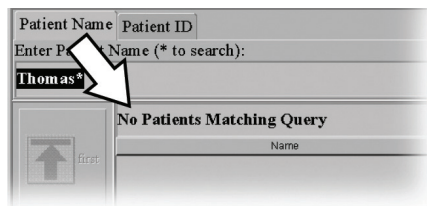

Figure 25: No Patients Matching Query Message

4.4 Searching Patient Data on a System Without a Worklist

The Acquisition Workstation Local database contains the demographic information for un-reclaimed Patients examined on this system, and selected patients from the Worklist Patient Query. The Worklist/Local Exams tabs do not exist if your system is not configured for a Modality Worklist Provider.

1. Select the **Patient Name** or **Patient ID** tab, enter the information to search for, and click **Search**. The search results are listed. The arrows on the left side of the screen assist in scrolling through the list.

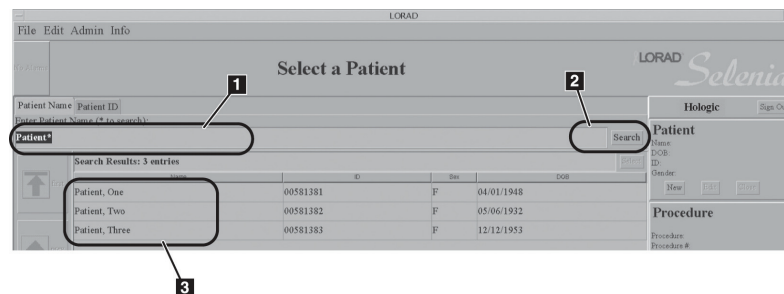

Figure 26: Search for a Patient in a System Without a Worklist

2. Select the Patient from the list. The patient's procedure displays in the Patient View screen.

5.0 Choose a Procedure



Note

A Procedure ID tracks a Procedure (series of images). This ID relates the images to a particular Procedure and Patient.

This option only appears when the patient has more than one scheduled procedure.

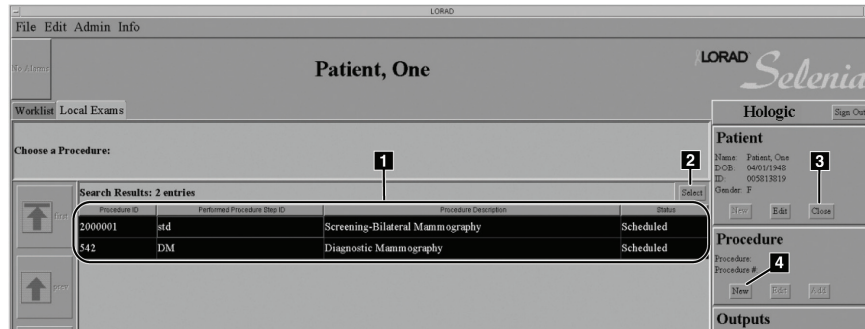

Figure 27: Choose a Procedure

Figure Legend

1. List of Procedures for a Patient with more than one scheduled Procedure.
2. **Select** Button to open the procedures you have selected.
3. **Close** Button to close the Patient without opening any Procedure.
4. **New** Button to schedule a new Procedure.

6.0 Patient View Screen

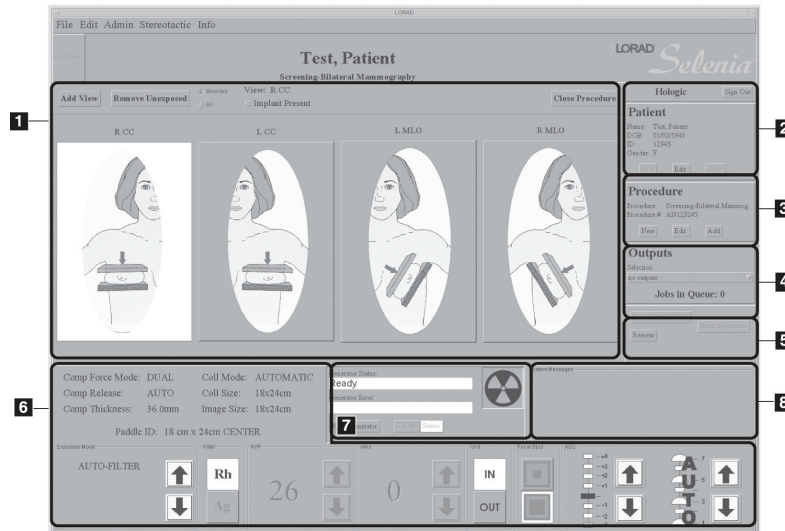

Figure 28: Patient View Screen Panes

Figure Legend and section where discussed:

1. Patient View Icons Pane, Implant Present: *Implant Present* on page 49
2. Patient Pane, **Edit** button: *Edit Patient Data* on page 64
3. Procedure Pane
 - **New** button: *Add a New Procedure to an Existing Patient* on page 64
 - **Edit** button: *Add a New Procedure to an Open Patient* on page 65
 - **Add** button: *Add a New Procedure to an Open Patient* on page 65
4. Outputs Pane: *Select the Output* on page 46
5. **Special Mode** Buttons
 - **Non-Imaging Mode** button: *Non-Imaging Mode Button* on page 67
 - **Simulate Capture** button: *Simulate Capture Button* on page 69
 - **Review** buttons: *Review Button* on page 69
6. Exposure Information and Techniques Pane: *Selecting Exposure Modes* on page 41
7. Generator Pane
 - Generator Status: *Acquiring Images* on page 47
 - Generator Error Message: *Generator Related Alarms* on page 146
 - **Reset Generator** button: *Digital Image Receptor Related Alarms* on page 146
8. System Messages Pane: *Tables of Messages and User Actions* on page 149

6.1 Patient View Screen Options

This chart diagrams the choices available on the Patient View screen.

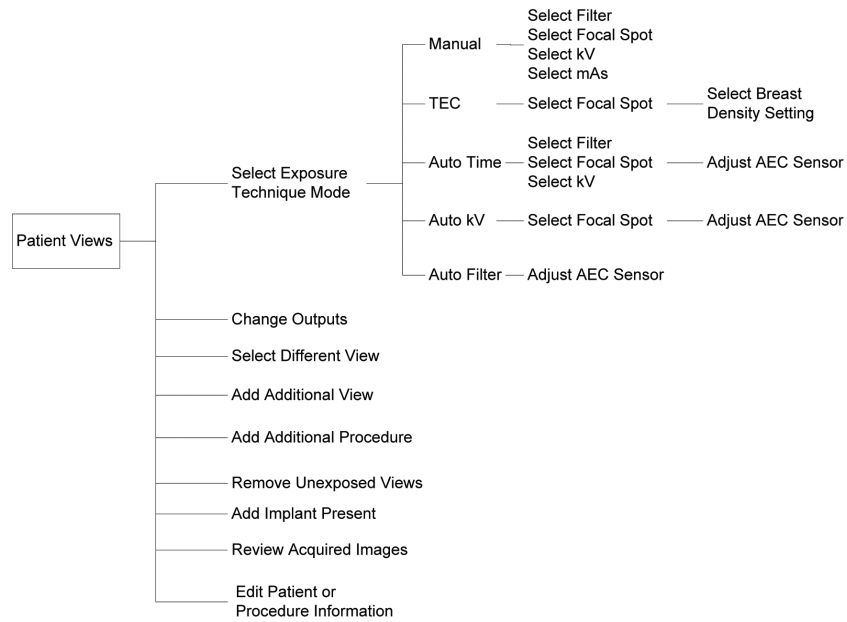

Figure 29: Patient Views Options

The next step in the normal workflow is to select an exposure mode for the procedure.

6.2 Selecting Exposure Modes

Selenia functions in these Exposure Modes:

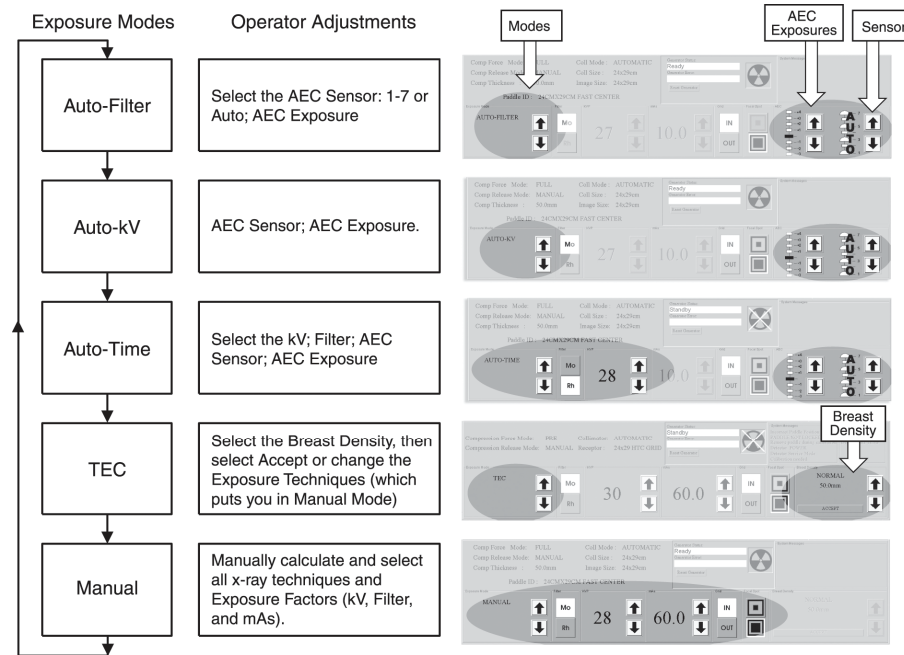

Figure 30: Exposure Modes

To choose the mode, click the up/down arrows in the Exposure Mode pane (the lower far-left box). The exposure defaults for that mode appear to the right in the pane. For more information about setting defaults, see *Set Technique Defaults Screen* on page 81.

Use the trackball or the function keys to change Exposure techniques.



Note

Changing the mode resets all Exposure Techniques to the defaults for that mode.

6.3 TEC Exposure Mode

The Gantry reads the compressed breast thickness and updates the recommended x-ray exposure parameters for kV, mAs, and filter using the standard reference table. It continues to update and recalculate until you override or accept the techniques.

1. Verify the selections are appropriate and:
 - Either click **Accept**, below the breast thickness (or press **Enter**).
 - Or change the techniques you do not agree with (Override mode).

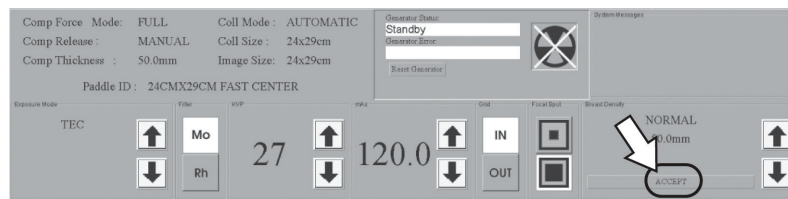

Figure 31: Accepting TEC Techniques

If you agree and click **Accept** in the Breast Density box, the system is in the Accept Mode.

- It stops recalculating the Technique settings.
- It displays "Ready" in the Generator Status message on the screen.
- It is ready to acquire an Image.

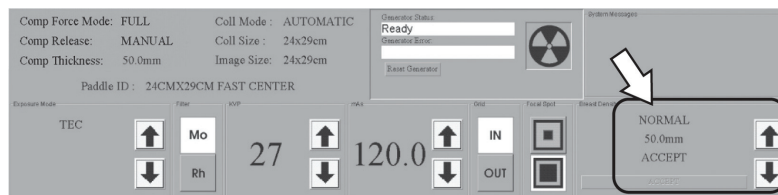

Figure 32: TEC with Techniques Accepted

If you change one or more of the parameters (kV, mAs, or filter), the system enters Override Mode:

- It stops recalculating the Technique settings.
- It displays the Override message on the screen.
- It is ready to acquire an Image.

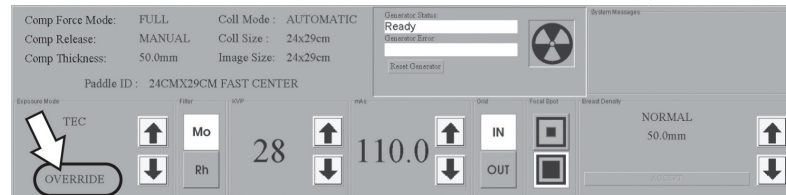

Figure 33: Override Mode

The Mammography unit remains in standby until one of the two modes appears. When the Override message displays, the system is ready to acquire an image

6.4 AEC Exposure Mode

AEC is calibrated to give a set dose for a standard breast (50/50, 4.5 cm thick). During AEC, the kVp is calculated by the set AEC table as a function of compression thickness. The pre-exposure (50 milliseconds) is used to calculate the mAs. During the pre-exposure, the resulting pixel value is evaluated and the appropriate mAs that produces a targeted pixel value is determined.

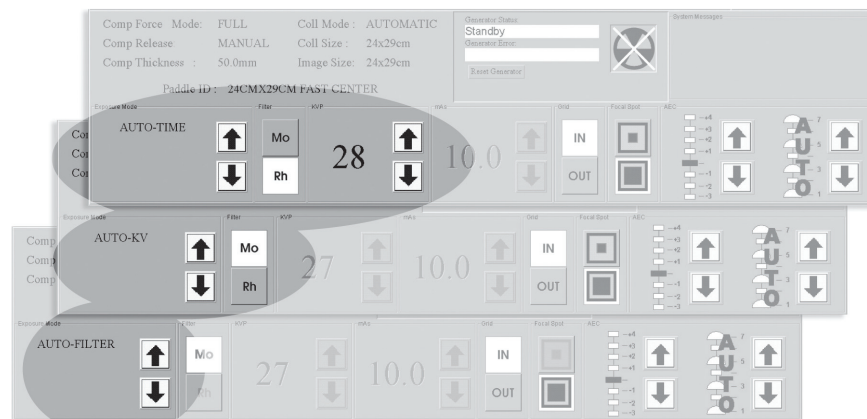

Figure 34: AEC Modes—Choices That Must be Made by the Technologist

Table 4: AEC Mode—Available Selections

AEC Mode	Techniques
Auto-Time	Filter = user selected kV = user selected mAs = calculated from Scout Pulse
Auto-kV	Filter = not selectable (Mo if Mo tube, Rh if W tube) kV = calculated from compression thickness and lookup table mAs = calculated from Scout Pulse
Auto-Filter	Filter = calculated from thickness and lookup table kV = calculated from compression thickness and lookup table mAs = calculated from Scout Pulse

6.4.1 Auto-Time Mode

In Auto-Time mode, select all exposure factors except mAs, and use Auto AEC or select the AEC Sensor Position. Auto-Time terminates the exposure after the AEC circuitry senses a pre-determined amount of radiation. A final mAs value displays after the exposure.

6.4.2 Auto-kV Mode

In Auto-kV mode, the system automatically selects the exposure kV and mAs. Once you select the Focal Spot and the AEC Sensor position or Auto AEC, the system is ready for the exposure. A Final kV, Post-mAs value, and Filter selection displays after the exposure. (The Filter is not selectable; the filter defaults to Mo if the system is configured with a Molybdenum x-ray tube and Rh if configured with the Tungsten x-ray tube.)

6.4.3 Auto-Filter Mode

In Auto-Filter mode, the system automatically selects all the Technique factors. Once you select the AEC Sensor position or Auto AEC, this is a fully automatic operation. The system automatically sets the kV using the lookup table based on the compressed breast thickness and changes the filter type when indicated by the table. A Final kV, Post-mAs value, and Filter selection displays after the exposure.

6.4.4 AEC Exposure Adjustment Settings

If you increase or decrease the targeted pixel value by using the Exposure Adjustment Settings, each step changes the target pixel value by approximately 15% which corresponds to a change in dose of the same magnitude.

The control range is from +4 to -3 to increase or decrease the exposure. Each step corresponds to a 15% change in exposure from the previous step. The calculated mAs increases or decreases with this change and remains until you change it or reboot the system.



Warning:

You increase the patient dose to high levels if you increase the AEC exposure adjustment setting. You increase the image noise or decrease image quality if you decrease the AEC exposure adjustment setting.



Warning:

An increased exposure adjustment leads to a higher dose to the patient. Keep the patient dose as low as practical to get good image quality.

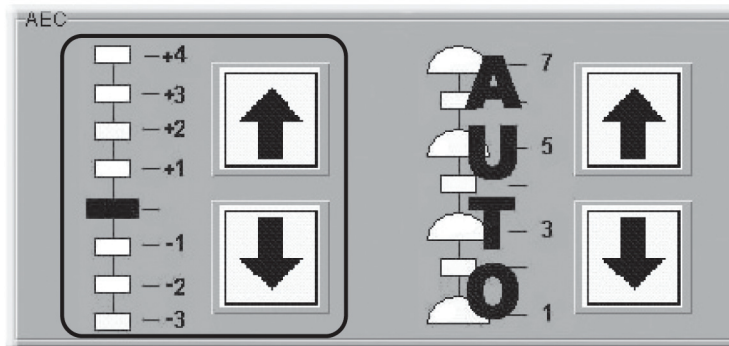

Figure 35: AEC Exposure Adjustment Setting on Screen

6.4.5 AEC Sensor Position Indicator Settings

You can select one of the seven positions to define the area of interest for AEC calculations. You can also select Auto AEC where a larger area is evaluated for the densest areas of the breast, and those are considered for the AEC calculation.



Note Always be aware of the position of the AEC Sensor when making AEC exposures.

Set the AEC Sensor Position after compressing the breast. There are three ways to change the AEC Position selection:

- The buttons on the compression device.
- The AEC Pos key on the keyboard.
- The AEC position arrows on the Acquisition Workstation display.

The displays on the side of the Compression Device and the lower right corner of the screen indicate the position setting.

The AEC Sensor Position has eight available positions.

- Positions 1 through 7 are manual selections, from the chest wall edge (position 1) to the nipple edge (position 7).
- Position 8 (Auto) automatically positions the sensor after sampling, and adjusts the sensor position for the two 1 x 1 cm regions.

The AEC Sensor uses areas of the detector rather than physical radiation sensors used in screen-film systems. There are two types of AEC Sensors. The Fixed AEC Sensor is used when a selection from 1 to 7, corresponding to the markings on the screening paddles, is selected. Manually selected Sensor positions do not change from your selection unless the collimator size decreases. This happens when:

- A smaller compression paddle changes the collimator.
- Shifting a paddle will change it to Auto AEC Position.
- The collimator override is used to select a smaller size.

Then, if necessary, the AEC sensor position moves to just within the field. (This change does not occur when the collimator size increases.)

The Auto AEC Sensor covers a larger area. A detector region, with a size defined by paddle and shift position, is used. This region is divided into approximately 1 cm² areas. Auto AEC positions one sensor beneath the densest part, and the second beneath the next densest area and averages them.

When viewing an AEC Preview, you can display the AEC Sensor area(s) without regard for which method, Manual or Auto Sensor, was used for the exposure. See the *figure AEC Exposure Adjustment Setting on Screen* on page 45.

6.5 Select the Output

To change an Output, select a new output from the drop-down list. When you change the Outputs option, a dialog box appears, informing you of the change. Click **OK**. If you select an output with no destination devices, the dialog box asks if you really do not want any outputs. If this was a mistake, reselect the output. Outputs can be a group of outputs, for example, a diagnostic review workstation and CAD, a combination of printers, and an archive system. For more details about outputs, see *What Must I Know to Acquire Images on Patients with Implants?* on page 4.

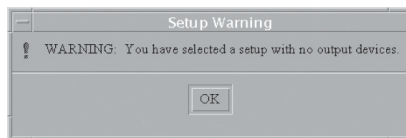

Figure 36: No Outputs Warning



Note

Only accepted Images are sent to the outputs. Rejected Images are sent to a storage area.

6.6 Implant Present - Patient View Screen

If the patient has an implant, select the Implant Present checkbox above the views. All the images are marked as having an implant and Implant Processing is applied to all views until the box is unchecked or you close the procedure.



Note

Select the **Implant Present** box for all Implant views and Implant Displaced (ID) views.



Note

For full Implant views, use either AEC (Auto Filter) or Manual Exposure Modes. For Implant Displaced views, use AEC and manual placement of the AEC sensor. See *What Must I Know to Acquire Images on Patients with Implants?* on page 4.

7.0 Acquiring Images

The system is ready to acquire Images when the Generator Status indicates "Ready" and the X through the x-ray symbol in the Generator Status box is not displayed. The Generator Status Message changes during the X-ray: Boost, Rotor, X-ray On (the high-pitched tone starts), X-ray Off.



Warning:

Do not move the C-Arm while the system retrieves the image.

8.0 Working with Images

You use the Preview Image screen to:

- Evaluate the Exposure Index and the Preview Image
- Add Comments
- Edit the View
- Make enhancements with the Preview tools
- Accept and reject images

8.1 Preview Image

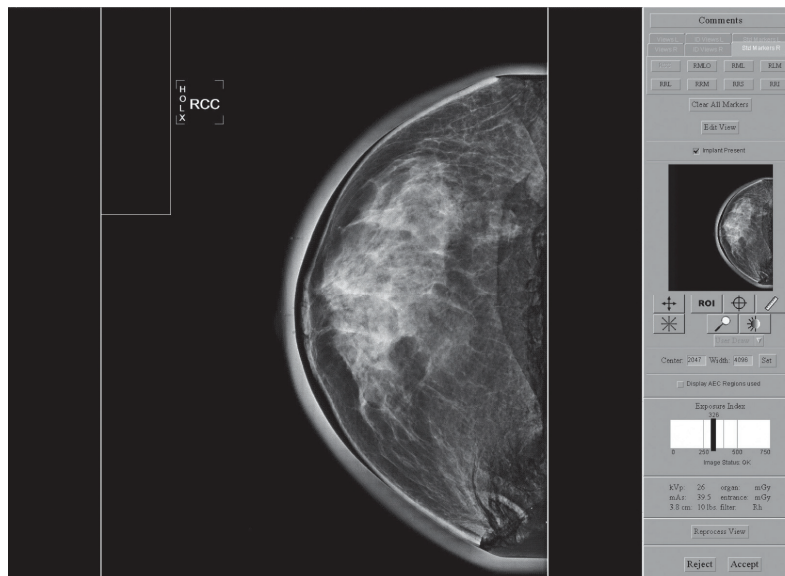

Figure 37: Image Preview Screen

The Acquisition Workstation proceeds into the Preview mode as the image is processed. The Preview Image is a non-diagnostic version of the image with processing applied for confirming anatomy and positioning. The Image pane displays how the image looks at the output device, scaled down 4:1. The Patient Name, ID, and View appear on the top bar of the Preview.

You may apply Window/Level adjustments or use other Preview tools located on the right side of the screen. Any changes to the Window/Level will not be saved to Outputs.

8.1.1 Progressive Preview

Generally, the first preview image is available in a short time for a quick evaluation of positioning. This first preview image updates with an improved preview image, which provides better image quality to evaluate motion or image artifacts.

8.1.2 Film Label Area

The small rectangle in the upper left corner is the film label area and is blank in the Preview. The label box is shown to ensure that there is no anatomy underneath the box, since that is where the label appears if the image is printed.

8.1.3 Digital Markers

A Digital Marker next to the label appears automatically. The technologist's initials are displayed and the chosen View selects the appropriate marker. You can click and drag the marker or change it using the Markers buttons on the Tool Bar.

8.1.4 Hanging Options

Images are presented on the screen as chest wall on the left or right (Dorsal or Ventral.) The graphics in this manual are all in **chest wall on the right** (or Dorsal) mode.

These options can affect how images display on your diagnostic review workstation and should be confirmed with the Vendor.

8.2 Comments

The **Comments** button allows you to enter or modify Image Comments during the Procedure while the Preview screen is open. The exact comment text is copied into the DICOM header of the Acquired Image. The diagnostic review workstation displays any comments. The comments can be printed on film output from the diagnostic review workstation.



Note

Clicking **Clear Comments** removes all of the image's comments.

8.3 Implant Present

A checkbox was available in the Patient View screen to allow you to mark when an implant is present. The Preview screen displays an Implant Present checkbox which you can select or unselect to change the information.

8.3.1 How to Correct Implant Information Before You Accept the Image

If you realize the implant information on an acquired image is incorrect before you Accept the image:

1. Click the **Implant present** checkbox on the Preview Screen.
2. Click the **Reprocess View** button on the bottom of the preview screen. The image is reprocessed and you can then click **Accept**.

8.3.2 How to Correct Implant Information After You Accept the Image

If you realize the implant information is incorrect and you have already accepted the image:

1. Repreview the image by clicking the thumbnail.
2. Select or unselect **Implant Present** on the Preview screen.
3. Click the **Reprocess View** button.
4. Click **Save**. A Send Image to Output dialog box asks you to confirm that you want this image sent to the selected outputs.
 - If you click Yes, images are sent to the selected output(s) group.
 - If you click No, the image can be resent using Image/Spool Management.
5. The incorrect image was sent to the chosen outputs. Corrections must be made and then you must use Image or Spool Management and resend the corrected image. See *Using the Repreview Option* on page 94.
 - If you printed the image, collect and discard the incorrect image.
 - If the image was sent to a diagnostic review workstation, delete the incorrectly processed image.
 - If the image was sent to the PACS, contact the PACS administrator and have them delete the incorrectly processed study.

8.4 Zoom/Pan

Two methods of Zoom/Pan are available: Quick Zoom/Pan and Full Zoom Pan.

8.4.1 Quick Zoom/Pan



When Quick Zoom/Pan is active, a magnification of the Preview Image displays using the entire Preview area. The magnification factor depends on the paddle. The 24 x 30 cm paddle has less magnification than the others. The placement defaults on the centerline of the chest wall. Activation and deactivation of this feature does not affect any crosshairs or line measurements.

8.4.2 Full Zoom/Pan



Full Zoom/Pan is available after the final image is prepared. When Full Zoom/Pan is active, a 70-micron magnification of the Preview Image is shown using the entire Preview area. Each pixel of the image display represents a detector pixel. Activation and deactivation of this feature does not affect any crosshairs or line measurements.

This thumbnail view, seen at the upper right part of the screen, indicates where the magnified view is located in relation to the entire image. You can drag this box to get to where you want to be in the image.

8.5 ROI

The ROI Statistics dialog box shows the:

- Location of the left, top and the width and height of the ROI box in pixel units.
- Minimum and maximum pixel value with in the ROI box.
- Mean, standard deviation, and signal-to-noise ratio (SNR) measurements for the ROI. SNR does not compensate for the DC offset and should not be used for QC.

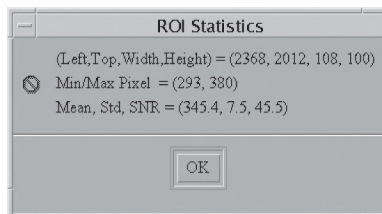



Figure 38: The ROI Statistics Information on the Preview Screen

8.6 Measurement

This feature measures distances on the image.

1. To clear the line, click the '+' at either end of the line.

- Click the **Measurement tool**  to turn Measurement off or to hide the numbers.
- Turning the Measure tool off does not clear the caliper lines. They are automatically cleared when the Preview window is closed.
- Caliper lines are not saved or recalled.
- You can draw multiple lines.

8.7 Magnification

Magnification of the image is available with a short delay after the image appears. The

button labels appear when this option is available. Using the Magnifier , you can view part of the image at 2X the currently displayed resolution.

A full resolution view of a part of the image is available when the Acquisition Workstation receives the entire image. You can also use the magnifier on that full zoom image after locating an area of interest and clicking the magnifier to further magnify that area.

8.8 Window/Level



Note

This operation has no effect on the final processed Image.

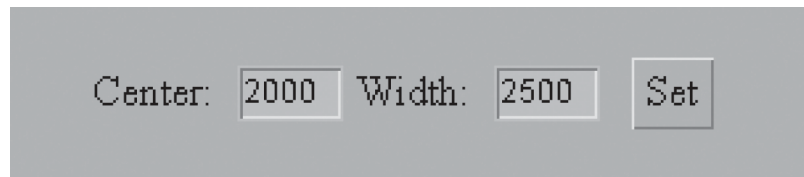

Figure 39: Changing the Window/Level Settings



You can edit the **Window/Level** by clicking in the box you want to change and entering a new number. When you click **Set** the image display changes to the new setting. Double click the image to return to the original setting.

8.9 Cropping

The Acquisition Workstation images are acquired with a collimated x-ray source. When an 18 x 24 cm or smaller paddle is installed with automatic collimation, the system crops the image to 18 x 24 cm. The area outside is not stored. You cannot change cropping. When manual collimation is selected, cropping follows the field.

8.10 Accept or Reject Images

8.10.1 Accept Button Details

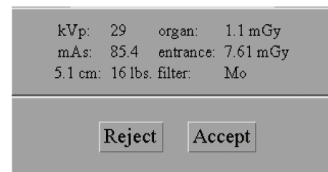

Figure 40: The Accept Button

When you accept the Preview Image:

1. The full resolution image with all associated attributes is marked as accepted in the spool space. Acceptance "freezes" the Acquired Image, and no subsequent action changes any attribute of an Acquired Image. It can be rejected later.
2. The system transmits the image to the selected destination output devices.

8.10.2 The Image Repetition Information Dialog Box

When you have already accepted an image for a view and then acquire and accept a second image for the view, the Image Repetition Information dialog box appears. Except for the choices Body Habitus and Wire Localization, the information collected here goes in the Repeat/Reject report count for the logged in technologist.

Select the reason for the repeat and close the dialog box.

8.10.3 Reject Button Details

To reject an image:

1. Click **Reject**. An **Image Rejection Information** dialog box appears, listing possible reasons for rejection and providing a text field for typing a reason.
2. Select a reason for rejection.



Note

This information is used in the Reject Analysis (required for Quality Control.)

1. Click **Reject** to close the dialog box, or click **Return to Preview** if you decide not to reject the image.
The system moves the image to the Reject Bin.
2. After you reject an image, the Preview closes and you can:
 - Re-acquire the rejected View.
 - Select a different View.
 - Close the Procedure.

An asterisk is displayed next to the view label of any views with a rejected image.

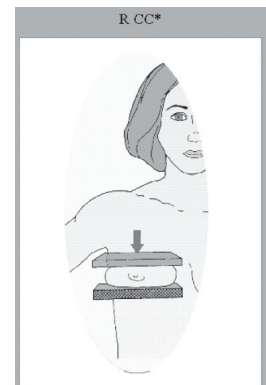

8.11 Accept a Rejected Image

You can reverse the Rejection process at any time. If you reverse the rejection process before the procedure is closed, the change is reflected in the Reject Analysis Report. If you reverse the rejection process after the procedure is closed, the change is not reflected in the Reject Analysis Report.

If you decide that a Rejected Image is better than the following image:

1. Reject the second image following the steps in *Accept or Reject Images* on page 52.
2. In the Patient View screen, click **Review** (below the Outputs box).

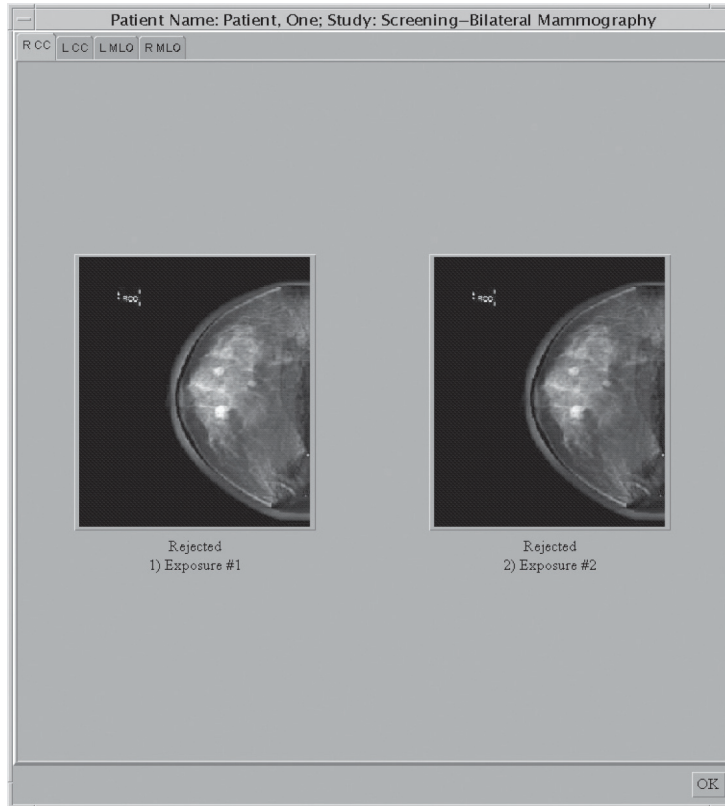
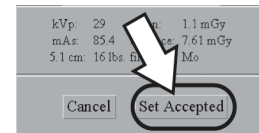

Figure 41: Review Dialog Box Showing Two Rejected Images.

3. In the **Review** dialog box, select the **View** tab for the View. (for example, R MLO).
4. Click the **Rejected Image** thumbnail you now want to accept. A Preview image appears.
5. Click **Comments** if you wish to add or delete comments.
6. Click **OK** to close the **Comments** dialog box.
7. Click **Set Accepted**.
8. Click **OK** to close the **Review** dialog box. The Accepted Image appears as a thumbnail on the Patient View screen.



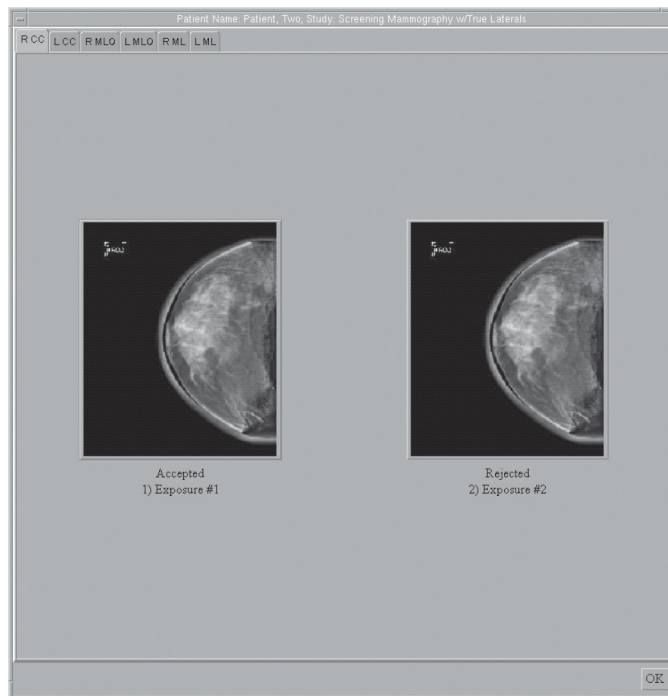

Figure 42: Accept Rejected Image

8.11.1 Sending Accepted Rejected Images to Outputs



Figure 43: Send Accepted Image to Outputs

When you accept a rejected Image, you must confirm that you want this Image sent to the selected outputs.

- If you click **Yes**, Images are sent to the selected output(s) group.
- If you click **No**, the image is not sent. It can be resent using Image/Spool Management at a later time.

8.11.2 Reject an Accepted Image

If you decide to reject the Accepted Image:

1. In the **Patient View** screen, click **Review**.
2. In the dialog box, select the **View** tab for the View you are rejecting.
3. Click the Accepted Image. The Preview screen displays.

4. Click **Set Rejected**. The **Image Rejection Information** dialog box appears.
5. Choose a rejection reason.
6. Click **Reject**. The system reprocesses it and labels this image rejected.
7. Click **OK**. The displayed thumbnail disappears from the Patient View screen.

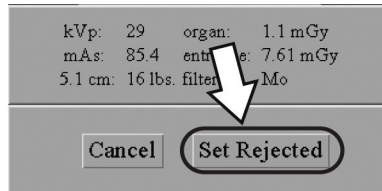

Figure 44: Set Rejected Button



Note

After you reject an Image using this method, it is **not** removed from the outputs destination queues, for example, diagnostic review workstation, or archive. It can be deleted from the queues. See *Manage Queues* on page 97. The Rejected Image is added to the reject analysis bin for tracking purposes.

9.0 Working with Images After They Are Accepted

9.1 Send the Images to the Output Devices

After you accept an image, the Acquisition Workstation sends the image to the destination devices in the selected output. The system makes entries in all queues that are on the output list for the image. If you accept a rejected image, confirm that you want this image sent.



Figure 45: Send Accepted Image to Outputs

If you ignore the warning and acquire images with no output selected, use the Resend function to send those images to an output. The system saves all Acquired Images on the Acquisition Workstation hard drive regardless of the output selection. The system reclaims space in the Image spool only after the Image is successfully sent to all of its output destinations. See *Automatic Reclamation of Hard Drive Space* on page 89, for details.

9.2 Patient View Screen with Thumbnails

After the Image is accepted, a thumbnail view of the Image replaces the icon on the Patient View screen, and the system transmits the Image to its outputs. Click the thumbnail to repreview the image.

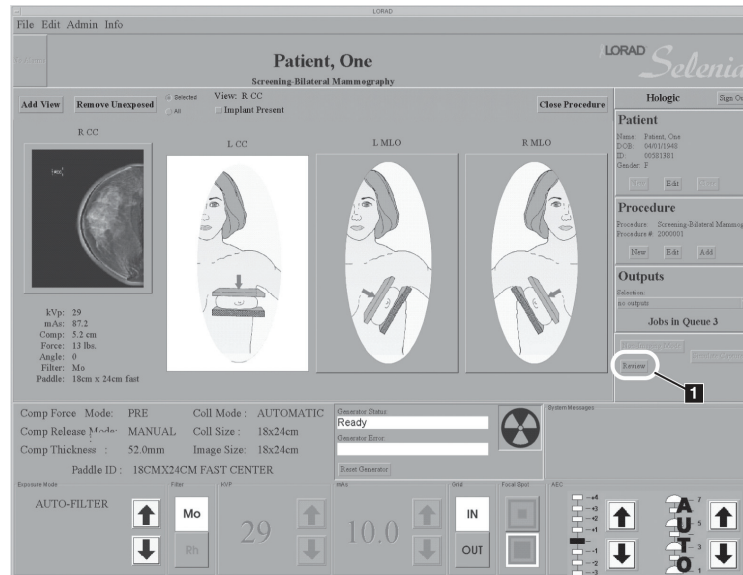

Figure 46: Patient View Showing Acquired Image

9.3 Exposure Taken Using an Incorrect Icon

9.3.1 You Have an Edit View Button



If your Preview screen looks like this in the top right corner and an incorrect view is acquired (e.g., RCC icon highlighted, but patient is positioned for LCC):

- If you *have not* accepted the image:
 - a. Select the **Edit View** button.
 - b. Select the correct view.
 - c. Select **OK**. A corrected thumbnail replaces the incorrect icon. Add another view for the icon that was replaced.

- If you *have* accepted the image:
 - a. Repreview the image.
 - b. Make the view corrections. See *Image/Spool Management* on page 92 for Repreview and Resend directions.

9.3.2 You Do Not Have an Edit View Button

If your Preview screen looks like this in the top right corner and an incorrect view is acquired (e.g., RCC icon highlighted, but patient is positioned for LCC) there are two scenarios to consider:



Scenario One

The mistake is discovered *before* the image is accepted:

1. With the Preview screen displayed, click the **Clear All Markers** button (upper right side of screen); the incorrect marker is removed.
2. Click the correct marker tab.
3. Click the correct marker. A new marker appears on the preview image.
4. Use the table on the following pages as a guide to determine if additional changes are required. These changes may include:
 - Drag the new marker to the bottom of the image. (This is done by putting your cursor on the new marker, then holding the left trackball button down while moving the trackball to move the new marker to the desired area.)
 - Change the Image Laterality (middle right side of screen).
 - Change the Patient Orientation Column.
5. Click the **Accept** button, after the changes have been made.

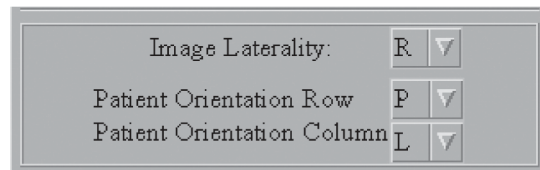

Note

The flipped images do not show on the Acquisition Workstation, but are shown on the SecurView®. They may not show on 3rd party systems.



Note

CCL, CV, RL, RM, TAN, CCID - these views all behave the same as CC.

ML, AT, MLOID - these views all behave the same as MLO.
LMO, SIO - these views all behave the same as LM.

Scenario Two

The mistake is discovered *after* an image once is accepted:

If the error is not corrected before you Accept the image, the system sends the incorrect image to the chosen outputs.

1. Corrections need to be made at the outputs before you resend the corrected image.
 - Printer —Collect incorrectly printed images and discard.
 - SecurView—Log on, user name-delete, click *Administration*, click the patient to be deleted, click the **Delete** button, then click the **Exit** button to close the window.
 - PACS—Contact your PACS administrator to delete the incorrectly marked study.
2. Corrections must be made in Image (or Spool) Management.
3. Select **Admin>Image (or Spool) Management**.
 - a. Search for the patient.
 - b. Click the thumbnail of the image that needs to be corrected.
4. Repreview the image to make the corrections.
 - a. Click the **Repreview** tab then the **Repreview** button.
 - b. Make the corrections as previously indicated in Scenario One.
 - c. Click the **Save** button. This creates an additional thumbnail showing the corrected image.
5. Click the **Resend** tab.
 - a. De-select the image that you have corrected.
 - b. Click the last thumbnail (corrected image), along with any other images that need to be resent.
 - c. Click the **Resend selected image(s)** button.
 - d. Go to Outputs, and select the correct outputs.
 - e. Click the **Resend** button.
 - f. Click the **OK** button in the Resend Confirmation dialog box.
6. Click the **Close** button (bottom right hand corner).
7. A manager can delete the incorrect image. See *Delete Image Function* on page 126.



Note

If there is any doubt of the accuracy of the corrected images, repeat the image.



Note

The correction may only be made if the procedure is still on the Acquisition Workstation.



Note

Be sure the incorrect images are still on the Acquisition Workstation before you delete them from the PACS.

9.3.3 Changing the View Selection

Table 5: Incorrect View Selection Changes

The view you wanted	View icon chosen in error	Change Marker to:	Drag	Image Laterality	Patient Orientation Column
RCC	RMLO	RCC	no	no change	no change
	RLM	RCC	bottom	no change	H
	RFB	RCC	bottom	no change	R
	LCC	RCC	bottom	R	no change
	LMLO	RCC	bottom	R	H
	LLM	RCC	no	R	no change
	LFB	RCC	no	R	L
RMLO	RCC	RMLO	no	no change	no change
	RLM	RMLO	bottom	no change	H
	RFB	RMLO	bottom	no change	R
	LCC	RMLO	bottom	R	no change
	LMLO	RMLO	bottom	R	H
	LLM	RMLO	no	R	no change
	LFB	RMLO	no	R	L
RML	RLM	RML	bottom	no change	H
RLM	RCC	RLM	bottom	no change	R
	RMLO	RLM	bottom	no change	H
	RFB	RLM	no	no change	no change
	LCC	RLM	no	R	L
	LMLO	RLM	no	R	no change
	LLM	RLM	bottom	R	H
	LFB	RLM	bottom	R	R
	RML	RLM	bottom	no change	H
RFB	RCC	RFB	bottom	no change	R
	RMLO	RFB	bottom	no change	H

Table 5: Incorrect View Selection Changes

The view you wanted	View icon chosen in error	Change Marker to:	Drag	Image Laterality	Patient Orientation Column
	RLM	RFB	no	no change	no change
	LCC	RFB	no	R	L
	LMLO	RFB	no	R	no change
	LLM	RFB	bottom	R	H
	LFB	RFB	bottom	R	no change
LCC	LMLO	LCC	no	no change	no change
	LLM	LCC	bottom	no change	H
	LFB	LCC	bottom	no change	L
	RCC	LCC	bottom	L	no change
	RMLO	LCC	bottom	L	H
	RLM	LCC	no	L	no change
	RFB	LCC	no	L	R
LMLO	LCC	LMLO	no	no change	no change
	LLM	LMLO	bottom	no change	H
	LFB	LMLO	bottom	no change	L
	RCC	LMLO	bottom	L	no change
	RMLO	LMLO	bottom	L	H
	RLM	LMLO	no	L	no change
	RFB	LMLO	no	L	R
LML	LLM	LML	bottom	no change	H
LLM	LCC	LLM	bottom	no change	L
	LMLO	LLM	bottom	no change	H
	LFB	LLM	no	no change	no change
	RCC	LLM	no	L	R
	RMLO	LLM	no	L	no change
	RLM	LLM	bottom	L	H
	RFB	LLM	bottom	L	L
LML	LLM	bottom	no	H	
LFB	LCC	LFB	bottom	no change	L
	LMLO	LFB	bottom	no change	H
	LLM	LFB	no	no change	no change
	RCC	LFB	no	L	R

Table 5: Incorrect View Selection Changes

The view you wanted	View icon chosen in error	Change Marker to:	Drag	Image Laterality	Patient Orientation Column
	RMLO	LFB	no	L	no change
	RLM	LFB	bottom	L	H
	RFB	LFB	bottom	L	no change

9.4 Close a Procedure

9.4.1 The Close Procedure Button



Figure 47: Patient View Screen's Close Procedure button

1. Click the **Close Procedure** button or press the **Close Exam** key on the keyboard when you have finished. The Procedure remains open until you specifically close it. The **Patient View** screen's **Close Procedure** button allows you to end the Procedure any time.

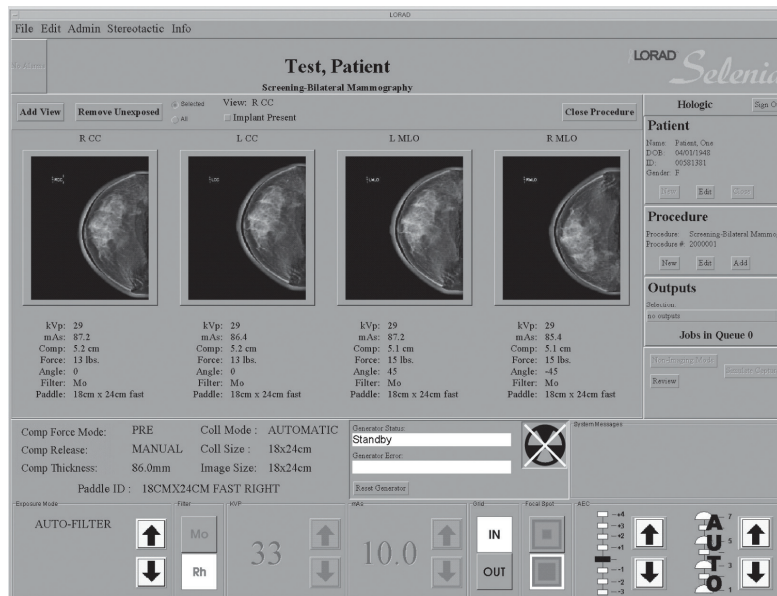

Figure 48: A Finished Standard Screening Procedure

2. If the Procedure is not finished, a dialog box appears. Select **Yes** to close. The Select a Patient screen displays.

9.4.2 Close a Procedure with MPPS Enabled

An optional feature is available for sites with an MPPS Service Class Provider. When this feature is installed, you have three buttons to use to close a procedure:

- **Complete** button: closes the active procedure and its status is labeled completed.
- **Pend** button: closes the active procedure and its status is labeled in progress.
- **Discontinue** button: closes the active procedure and its status is labeled discontinued. Discontinuing a procedure requires a reason.

10.0 Additional Actions on the Patient View Screen

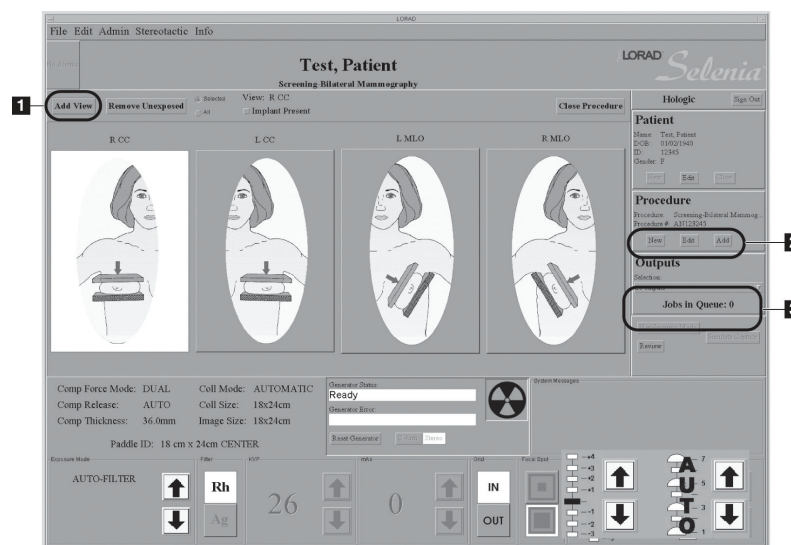

Figure 49: Patient Views Screen with Icon(s) for Scheduled Views

Figure Legend

1. Add View
2. Add or Edit a Procedure
3. Output selection drop-down list

10.1 Add a View to the Procedure

1. Click **Add View**, (see the *Figure Patient Views Screen with Icon(s) for Scheduled Views* on page 63, item 1).
2. In the dialog box, select an additional View(s) from the list of Standard Mammography Views. You can add multiple views by holding the Control key down while clicking.
3. Click **OK** to continue. The new View Icon(s) appears with the other views.
4. Select the new view before acquiring the image.

10.2 Remove Unexposed Views Button

Unused views or procedures are automatically reclaimed, or can be deleted manually with the **Remove Unexposed Views** button. When you click the button you need to select **All** or **Selected** to indicate which views are to be deleted.

10.3 Edit Patients and Procedures

10.3.1 Edit Patient Data

If information about the Patient has changed and needs to be edited:



Note

This procedure only changes the patient information of images in the study not yet taken. Acquired images will have to be resent using **Image Management** and **Resend** after the information is edited. See *Image/Spool Management* on page 92.

Do not edit patient information if using a Modality Worklist. Work with the HIS/RIS administrator to resolve incorrect patient information. See *Image/Spool Management* on page 92.

1. Click **Edit** in the **Patient Box**.
2. Select the field(s) with incorrect or missing information and make changes to the field(s). Use the Tab key or the trackball to move through the fields.
3. Click **Accept**. The dialog box closes and the main screen updates with the new information.



Note

The **Clear** button clears last name, first name, DOB, and age.

4. Verify that the correct changes appear in the screen before acquiring a new image.

10.3.2 Add a New Procedure to an Existing Patient

1. Recall the existing Patient.
2. Click **New** in the *Procedure* box and click **Yes to: Creating a New Procedure will close the current Procedure**. The **New Procedure** dialog box appears.
3. Click the **Accession Number** field. Enter a new **Accession** Number.



Note

The **Clear** button clears the Accession number so you can re-enter it.

4. Select the **Procedure Description** from the drop down list(s).
5. Click **Accept** and then click **Close** in the Patient Pane to close this screen.



Note

If the Patient already has more than one Procedure, you can add a new one directly from the Select a Procedure search screen. Otherwise, when you select the Patient, the scheduled Patient Procedure opens and you must close the Procedure before you can add the new Procedure.

10.3.3 Add a New Procedure to an Open Patient

You can have multiple Procedures open at the same time. This allows you to compare other images to a new image. To add a new procedure when you want the current procedure to remain open:

1. Click **Add** in the **Procedure Box**. The **New Procedure** dialog box appears.
2. Select the **Procedure Description** from the drop down list.
3. Click **Accept**. A new **Procedure** tab appears on the **Patient View** screen above the View icons and you can work with either Procedure.

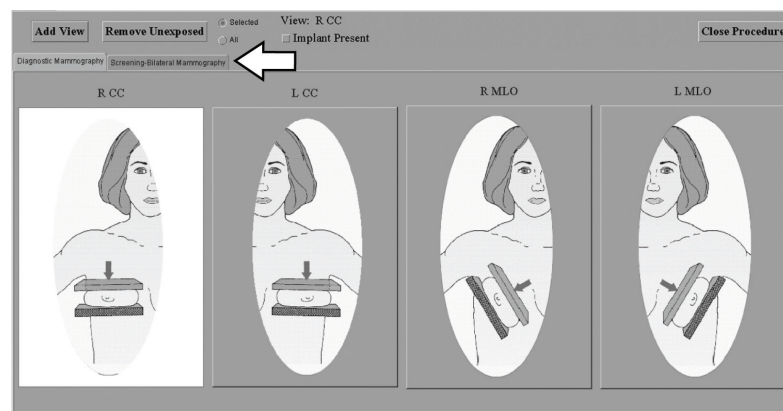

Figure 50: Results of Adding Another Procedure



Note

This new procedure must use the same Accession Number as the currently open procedure. Use the **New** button if this is not your intention. If your facility requires different accession numbers for different procedures you need to use the **New** button. See *Add a New Procedure to an Existing Patient* on page 64. It is not possible to change the Accession Number if you use the **Add** button.

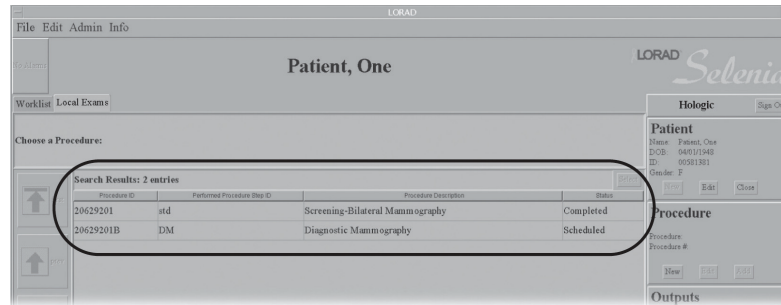

Figure 51: Selecting Two Procedures in the Choose a Procedure Screen

The images can be taken now, or later. If taken later, the two Procedures are treated as separate Procedures in the Choose a Procedure screen. They can both be opened as one by pressing and holding the Ctrl key and clicking each one. Then release the Ctrl key and click **Select**.

10.3.4 Changing Patient Information After Accepting an Image

Once an image has been accepted, it is immediately sent to the selected outputs. If any change to the accompanying information is needed, it must be reviewed, saved, and resent as an additional record and the previous record deleted.

Delete the incorrect image from the following outputs:

- **Printer:** Collect the incorrect printed images and discard them.
- **DRW:** Contact the Diagnostic Review Workstation manager to delete the incorrect image(s).
- **PACS:** Contact the PACS administrator and alert them to delete the incorrect study or advise another corrective measure.

To correct the information at the AWS:

1. At the AWS, click the **Local Exams** tab, then search using the first letters of the last name.
2. When the patient procedure displays on the screen, click **Edit** in the **Patient Pane**.
3. Change the incorrect patient information.
4. Click the **Accept** button.
5. If the **Accession Number** is also incorrect, click **Edit** in the **Procedure** Pane and make the correction.
6. Click the **Close Procedure** button.
7. Select **Admin>Image Mgt.**
8. Search for the patient using the first letters of the last name.
9. Click the **Repreview** tab.
10. Click the first thumbnail.
11. Click the **Repreview** button. The preview image appears.

12. Click the **Save** button.
13. Repeat steps 10 to 12 for the rest of the images in the procedure. There should now be eight thumbnails (assuming there were four in the original procedure.)
14. Click the last four thumbnails (the corrected views).
15. Click **Resend** to all required outputs.
16. After you confirm that the four images have been resent, you may want to go back into Spool Management and Delete the four images that are labeled incorrectly. (You have to be signed in at the manager level to do this.)

10.4 Non-Imaging Mode Button



Figure 52: Non-Imaging Mode Button

Non-Imaging mode allows you to make x-ray exposures without acquiring images. The medical physicist may use it during QC tests to measure the x-ray tube performance without having to wait for Images.

This mode:

- Is not available when you have selected a Patient.
- Deactivates the Image Receptor.
- Allows an x-ray prep/expose cycle to occur while overriding the Patient selection and Image Acquisition sequences.
- Is available to all users

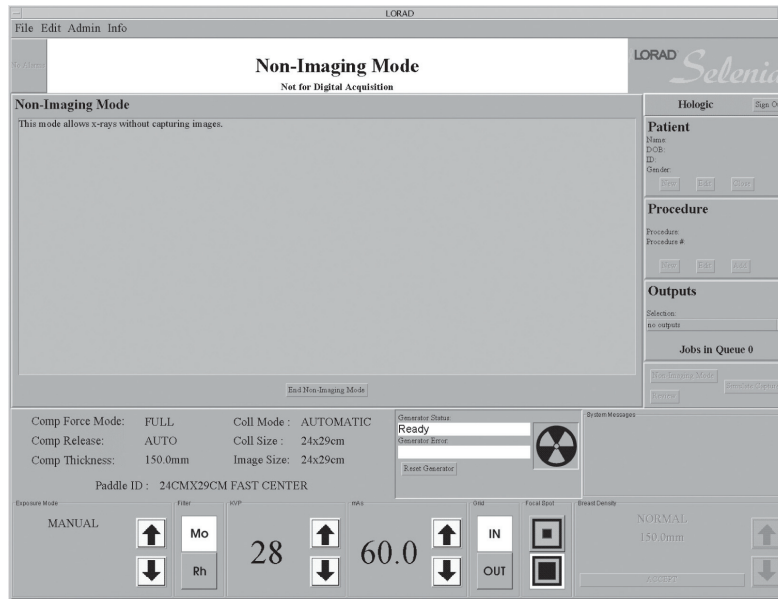

Figure 53: Non-Imaging Screen

When you click **Non-Imaging Mode**, a clear message appears stating that you are entering this mode.



Caution:

Protect the Image Receptor from excessive radiation by covering it with lead while using the Non-imaging mode.

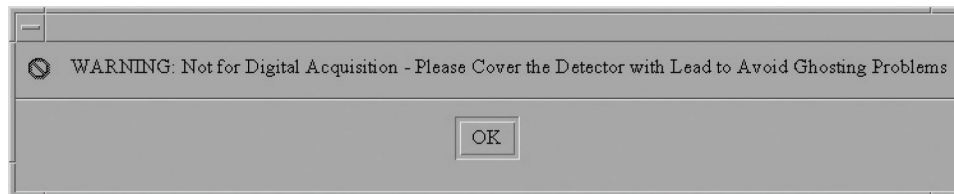

Figure 54: Non-Imaging Dialog Box Warning

To use this button:

1. Click **Non-Imaging Mode**. A Non-Image dialog box appears.
2. Click **OK**. The dialog box closes and the Non-Imaging window appears.
3. Follow the directions in the QC Manual or Service Manual to use the window.
4. Click **End Non-Imaging Mode** when finished.

10.5 Simulate Capture Button

This function is for use by service personnel only.

10.6 Review Button

This button, see the *figure Patient View Showing Acquired Image* on page 57, Item 1, is used for Reject /Unreject. Select the thumbnail to review an image.

11.0 Clinical Procedures

This section provides a suggested Sequence of Operation to acquire Patient Images, but it is not intended as a substitute for conventional clinical training and methodology.

The following three sections provide flowcharts for typical clinical procedures.

11.1 Manual Mode

In the Manual mode, you set all the Techniques. The defaults appear when you choose the View, and then you make any necessary adjustment for the individual exposure.

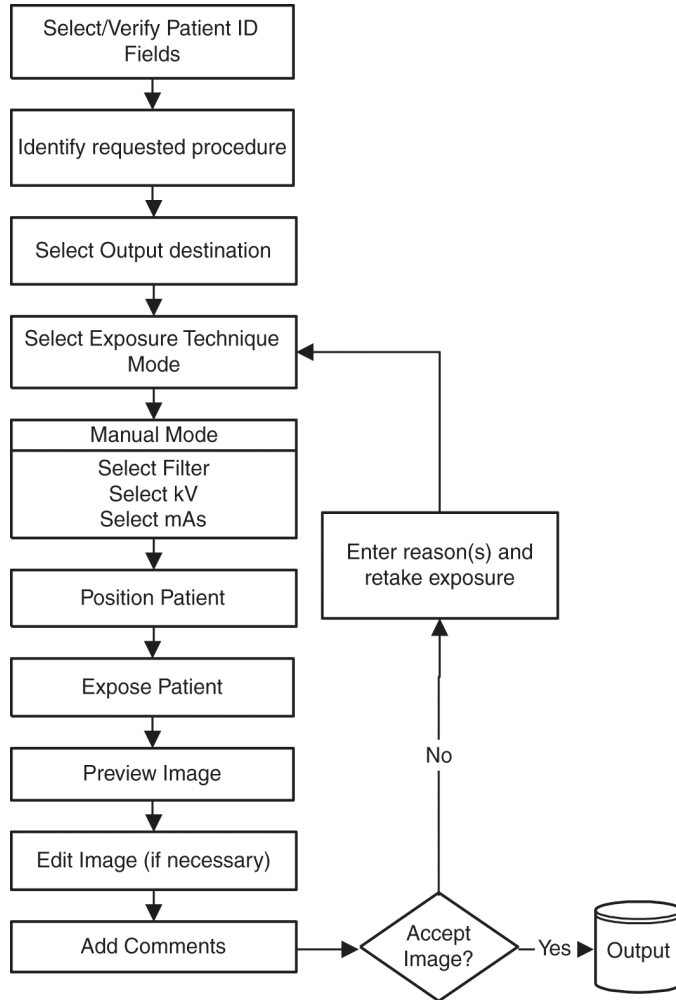

11.2 TEC Mode

A second mode available to you is the Tissue Exposure Control (TEC) Mode. It is an enhanced Manual Exposure Control mode.

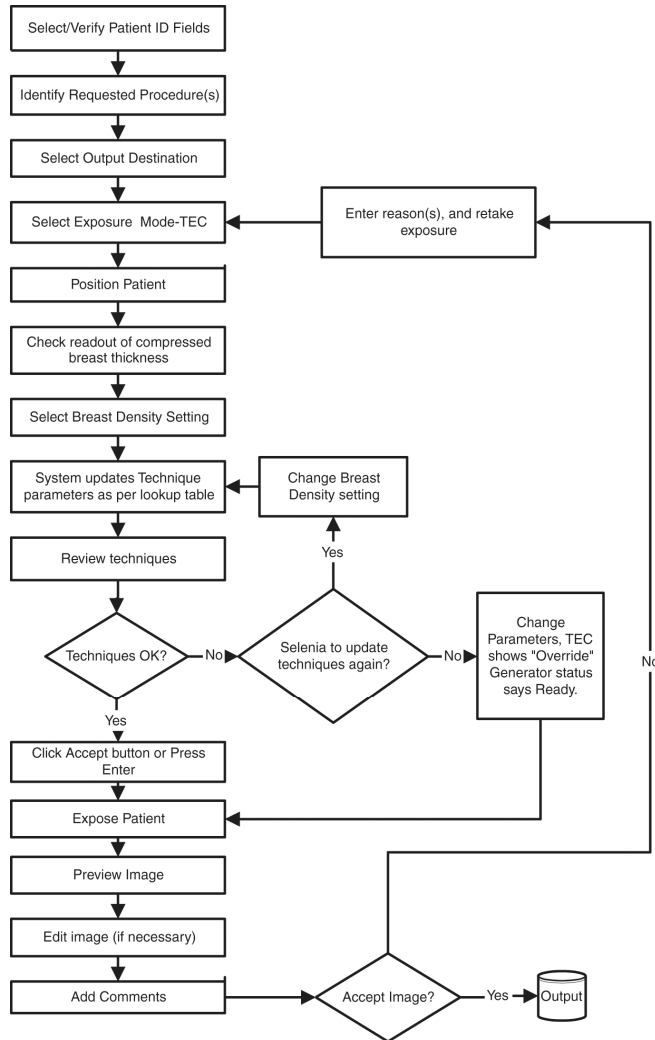

11.3 AEC Mode

The third mode available to the technologist is the Automatic Exposure Mode (AEC).

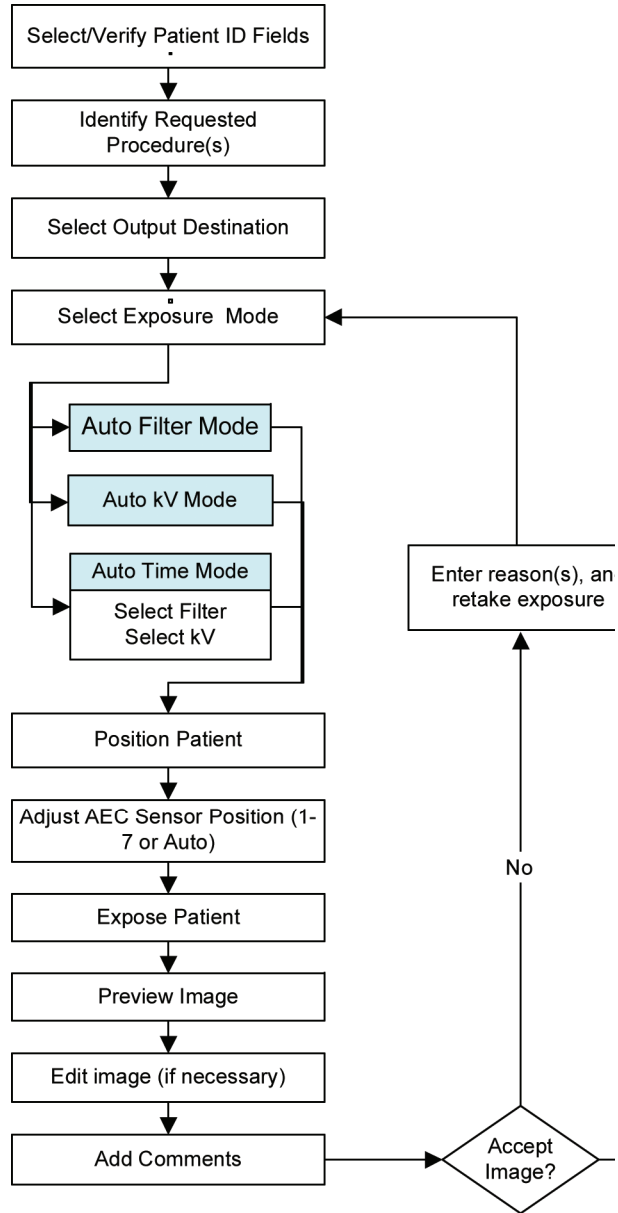

12.0 Performing a Screening Procedure

The Selenia is capable of performing routine screening, diagnostic studies, magnification studies, and localization procedures. Each of these procedures requires some different accessories, but all are performed in the same general sequence of steps. The procedure for selecting the patient and view for a Magnification or Spot procedure is the same as for a Standard Screening. A Localization procedure has additional steps, see *Performing a Localization Procedure* on page 76.

12.1 Select Patient, Procedure, Output, and Exposure Techniques

At the Acquisition Workstation:

1. Select a Patient from the Worklist or local database, or add a new one.
 - If your installation uses Patient or Procedure ID bar codes, use the bar code scanner to scan patient or procedure (accession) records in both the modality worklist and the local database.
 - If your installation does not use bar codes, search the modality worklist.
 - If your installation does not use a network, search the local database records.
 - If the patient is not in the local database, enter patient data using the keyboard.
2. Identify the required Procedure(s).
 - When working with implants, the beginning procedures are the same as a screening except select **Screening Mammogram w/Implants** procedure in **New Procedure** dialog box.
3. Select the Output Destination(s).



Note

If using the CR-RW drive as an output, see CD-RW Drive.

4. Select the first View.
5. Set the Exposure Mode and Techniques.

12.2 Set Up the Gantry



Warning:

The C-Arm movement is motorized.

1. Install the compression paddle for the procedure and any other necessary accessories.
2. Set the C-arm height and rotation angle.



Note

To help with patient positioning, the system memorizes oblique C-arm angles. After making an oblique exposure, the C-arm angle stores in memory. When you rotate the C-arm for the next exposure, the system automatically stops the C-arm at the opposite oblique angle. This is true for the C-arm Rotation switches, and the Gantry Rotation switches if equipped. You may then rotate the C-arm to an angle other than the memorized oblique angle to best accomplish breast positioning.

3. Ensure the light field illuminates the correct area for the installed accessories.

12.3 Position the Patient

1. Use the C-arm height controls to raise or lower the breast platform to accommodate each patient. Do not use any heating source, for example, heating pad, on the image receptor.
2. Use the C-arm Rotation-Release controls to move the tubehead to the required clinical projection angle. Displays on the Gantry show the current angle of the C-arm.
3. Move the patient up to the C-arm.
4. Position the patient as required.
5. Put the arm or hand of the patient on the Patient Handle or at the side of the patient. Inform the patient of the locations of all push button controls and give instructions to avoid contact with any controls.



Warning:

Be aware of the position of the patient's hands and arms relative to the C-arm controls.

6. Compress the breast.
 - Use the footswitch controls to provide hands-free compression control and C-arm height adjustment.
 - Use the light field lamp as necessary to visualize the x-ray field. Position the patient's breast within the illuminated field to ensure total coverage.
 - Apply compression slowly. Use the handwheels to make final compression adjustments.

12.4 Acquire the Image and Complete the Procedure

1. Confirm x-ray equipment parameters and Image Acquisition settings.
 - For full implant views, either AEC (Auto Filter) or Manual Exposure Modes may be used. See *Method One—Imaging Patients with Implants Away From the Nipple* on page 5 and *Method Two—Imaging Patients with Implants Near the Nipple* on page 6.
 - For implant displaced views use AEC and manual placement of the AEC sensor. See *Method Four—Imaging Implant Displaced Views* on page 7.
2. The system is Ready for exposure when:
 - The screen has no "X" across the radiation symbol.
 - The generator status says **Ready**.

If the system does not enter a **Ready** status in 60 seconds, verify that the accessories are correctly installed and the paddle is firmly locked into place.



Warning:

Always follow the safety precautions for x-ray exposures.

3. Press and hold the **X-ray** buttons for the entire exposure.

The Radiation icon on the screen changes from gray to white during this time and the x-ray Indicators by the buttons on the keypads glow yellow.
4. Release the patient.
 - If the compression release is set to manual or you are using a localization paddle, raise the compression device.
 - If the automatic release feature is set, the compression device automatically rises after the exposure.



Warning:

Do not move the C-Arm while the system retrieves the image.

5. Preview the image. Observe the Exposure Index to ensure the exposure is correct.
6. If required, use the Window/Level tool or other Preview options including Image Comments—all available at any time while the Preview screen is active.
7. Accept or Reject the image.
8. Perform the Acquisition cycle as many times as required for the requested Procedure(s).
9. If necessary, add an additional view or procedure.
10. Ensure the patient has safely moved away from the unit when you have taken all the Views.
11. Close the Procedure.

13.0 Working with Specimens

Follow standard procedure with the following considerations:

- Use a Magnification Stand if desired.
- Use a Spot Paddle.
- Bring the specimen as close as possible to the chest wall edge of the detector or stand.
- Use Manual Exposure Mode.

Note that you can use **Admin>Image Management>Resend** to resend to a printer if you need a second image for pathology.



Note

You can use the manual **collimation** button on the tubehead to expose the specimen only. This does not reduce the size of the image, but does mask out all unnecessary space. The minimum cropped size of a Selenia image is 18 x 24 cm. You cannot further reduce the image size for specimens.

14.0 Performing a Localization Procedure



Warning:

The system is configured to disable Automatic Compression Release when a Localization paddle is installed. If you use a paddle other than a Localization paddle during this procedure, you must disable Automatic Compression Release. On the Main Menu, click Edit>Standard Setup and change the Compression Release option from Automatic to Manual. Return this option to Automatic when the procedure is complete.

14.1 How to Use the Standard Crosshair Device

The Localization procedure has additional steps not needed in other clinical procedures.

1. Follow the standard screening procedures to step 3, *Set Up the Gantry* on page 74.
2. Install the Crosshair Device.
3. Change the Compression Release setting to **Manual** if set on Automatic.
 - a. Select **Edit>Standard Setup**.
 - b. Select **Manual** in the Compression Release field. Wait a few seconds before closing the window for the change to take effect.
 - c. Click **Close**.
4. Rotate the Crosshair Device out of the x-ray field before taking the scout image.

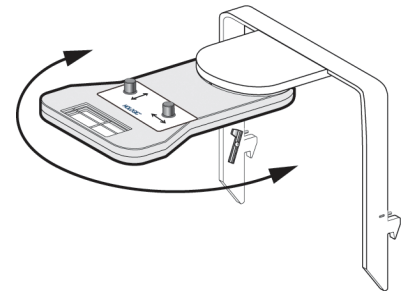

Figure 55: Rotate the Crosshair Device Out of the X-ray Field



Note Auto AEC is not available with localization paddles. Choose AEC position 2 or 3.

5. Take the scout image.
6. Click **Zoom/Pan** in the Preview window to see a magnification using the entire screen.
7. **Pan** the image by dragging with the right trackball button.
8. Click **Crosshair** and then click on the area of interest to display the crosshair lines.
9. Click **Zoom/Pan** button off to see where the crosshairs intersect with the alpha-numeric on the screen. This determines the horizontal and vertical position of the lesion.
10. Move the crosshair device into the field.
11. Turn on the light field lamp.
12. Adjust the crosshair knobs to place the crosshair shadows at the appropriate reference labels on the localization paddle. The intersection of the crosshair shadows on the skin indicates the position of the lesion on the scout image.
13. Note the position on the breast.
14. Move the crosshairs out of the x-ray field.
15. Continue with the Localization Procedure, changing paddles as required.

16. Upon completion of the procedure, change the Compression Release back to automatic if this is the site default.
 - a. Select **Edit>Standard Setup**.
 - b. Select **Automatic** in the **Compression Release** field. Wait a few seconds before closing the window for the change to take effect.
 - c. Click **Close**.
17. Use Standard Screening steps for the Procedure. See *Performing a Screening Procedure* on page 73.

14.2 How to Use the Magnification Crosshair Device

Follow the instructions in *How to Use the Standard Crosshair Device* on page 77 except:

1. Attach the Magnification stand.
2. Attach the Magnification Crosshair Device to the tubehead.
3. Check to make sure the Grid Out and Small Focal Spot are selected.
4. Dial the Crosshairs out of the way before you take the scout shot.
5. Remove the crosshair device after the needle placement when you are ready to continue with the procedure.

15.0 Accepting and Storing the Image

Use the Preview screen to:

1. Inspect for good positioning and proper exposure level.
2. **Accept** or **Reject** the image.
 - If it is acceptable, select **Accept** and wait for the image to appear as a thumbnail on the Patient Procedure screen.
 - If the image has problems (for example, under-exposure, movement) enter **Reject** and the reason it is unacceptable. Repeat the exposure.
 - Note the displayed actual exposure value. If a minimum exposure (250) is not achieved, the image should be rejected.

Accepting an image transfers it to the selected Output device(s).

Rejecting an image stores the image in the **Reject Bin**, and does not send it to the Output destination. All images, Rejected as well as Accepted, appear on the Procedure's **Review** of images. All **Rejected Images** are stored in a log with their reasons for rejection.

For additional information on accepting and storing images, see *Accept Button Details* on page 52.

16.0 Optional Workflow Operations

In addition to the workflows described above, optional operations are available to:

- Open multiple Procedures within a Patient. See *Add a New Procedure to an Existing Patient* on page 64:
- Search by either Patient Name or ID to Open a new Procedure for an existing patient. See *Add a New Procedure to an Open Patient* on page 65.
- Search by either Patient Name or ID to Recall an open Procedure to continue that Procedure. See *Choose a Procedure* on page 38.
- Resend previously acquired Images. See *Image/Spool Management* on page 92.

17.0 Main Menu Functions

Main Menu functions provide the technologist with easy access to non-routine Acquisition Workstation functions. They are always available while the Acquisition Workstation application is running unless a dialog box or Procedure is open.

This section describes additional details about the menus in the order they appear on the screen. If a menu item is not listed, there are no additional hints or descriptions about the item available beyond the information in *Instructions for Use*.

17.1 Main Menu with No Selected Patient

The table below lists the Main Menu functions for the technologist when a Patient Procedure is *not* selected. Once a Procedure is open, the Main Menu functions are not available.

Table 6: Main Menu Functions with No Procedure Chosen

Menu Function	Tech
File	Exit
Edit	Standard Setup
	View Order Editor
	User Setup
	Outputs
Admin	Image Management
	Protect Patients
	Manage Queues
	Eject
	Import
	Retrieve Priors
	PPS Status*
	Calibrate
Test Patterns	

Table 6: Main Menu Functions with No Procedure Chosen

Menu Function	Tech
	DR Device Control
	Available Disk Space
Info	About the Acquisition Workstation

*This only appears when the MPPS Service is installed.

17.2 File Menu>Exit

The **Exit** function provides options for exiting the system if a Patient/Procedure is not displayed. If a Patient/Procedure is open, a dialog box informs you that you cannot Exit while a Patient/Procedure is open. See *How to Log Out or Shut Down* on page 24.

18.0 Edit Menu

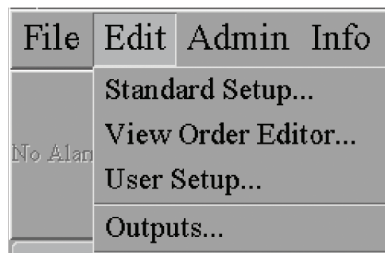

Figure 56: Edit Menu

18.1 Standard Setup Screens

On the Main Menu, click **Edit>Standard Setup** to display a list of startup defaults. The table below lists available options. Hints appear in the lower pane as the cursor moves over the different choices.

Table 7: Setup Choices

Choice	Range of choices
Pre-compression Force	10 - 100%
Full Compression Force	10 - 100%
Compression Force Units	Pounds (lb) or Newtons (N)
Compression Release Mode	Automatic or Manual
Compression Force Mode	Pre, Full, or Dual
Collimator	Automatic or Manual
Default Exposure Mode	Auto-Time, Auto-kV, Auto-Filter, TEC, or Manual
Default Magnification Mode	Auto-Time, Auto-kV, TEC, or Manual
Set Technique Defaults	See <i>Set Technique Defaults Screen</i> on page 81.

18.2 Set Technique Defaults Screen

The last button on the Standard Setup screen, **Set Technique Defaults**, displays the Technique Default Setup screen. Select *Manual* Exposure Mode to start. Remember to set the Magnification modes. Each possible default must be set up.

Table 8: Set Technique Default Choices

Mode	Choices
<i>Manual</i> (and Mag)	Filter, kVp, mAs, mAs Table, Focal Spot (Large or Small)
<i>Auto-Time</i> (and Mag)	Filter, kVp, mAs Table, Focal Spot, AEC Region position, and Density
<i>Auto-kV</i> (and Mag)	Filter not selectable (default is Mo for Moly Tube, Rh for Tungsten), mAs Table, Focal Spot, AEC Region position, and Density setting
<i>Auto-Filter</i> (and Mag)	mAs Table, AEC Region position and Density setting
<i>TEC</i> (and Mag)	Filter, mAs Table, Focal Spot, and Breast Density (Fatty, Normal or Dense)

18.3 View Order Editor

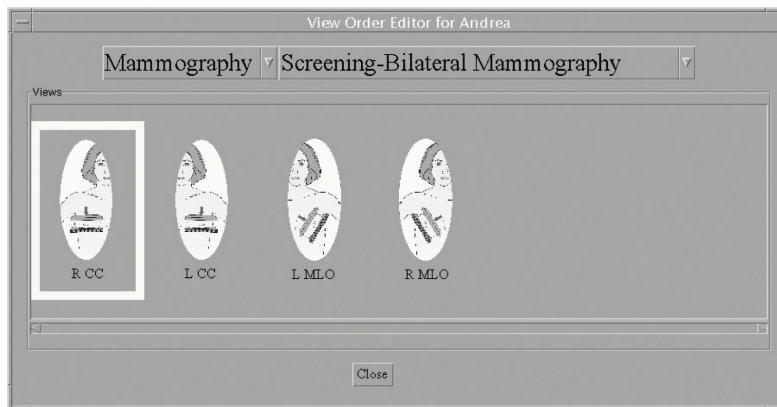

Figure 57: View Order Editor

To set up your individual view order defaults, drag the **View icons** to change their order. Select the procedure from the drop down list. You may set view orders for each Procedure. Click **Close**. Your **View Order** preferences are saved and load each time you log in.

18.4 User Setup—Add or Edit a User

Click **Edit>User Setup**. The **Edit Users** dialog box appears.

A user can only be added or deleted at the same or lower level as the user signed in.

Example:

- *Mgr* can add or delete a mgr or tech user.
- *Tech* can add or delete only a tech, not a mgr.

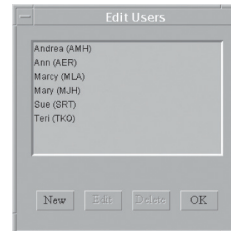

Figure 58: Edit Users Dialog Box

18.4.1 Add a New User

To add a new user:

1. Click **New**.
 2. Enter the requested information in the fields.
 3. Assign a password. The the password must contain at least 6 characters.
 4. Click **Accept** to add the user, or **Cancel** to leave without adding the user.
- The user name appears on the printed images.
 - The initials appear on the electronic image.

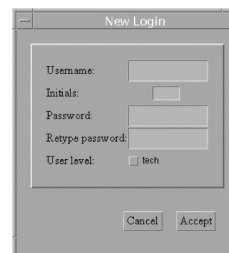

Figure 59: Add a New User

18.4.2 Edit Your Profile

To edit your initials or password:

1. Select your name from the list.
2. Click **Edit**. The **Edit Profiles for <name>** appears.
3. Change the Initials if necessary.
4. Enter your old password.
5. Enter a new password. The the password must contain at least 6 characters.
6. Reenter the new password to confirm it.
7. Click **Accept** to make the change.

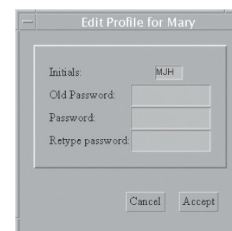

Figure 60: Edit User Profile



Note

You have to enter the password to change the initials.

18.4.3 Delete a User

To delete a user:

1. Select a User in the **Edit Users** dialog box to delete.
2. Click **Delete**.
3. Confirm the deletion in the **Delete?** dialog box by clicking **Yes**, or cancel the deletion by clicking **No**.

18.5 Set Up Outputs

An Output is a pre-defined list of one or more physical output devices, which determines where to send images from the Acquisition Workstation. Outputs are initially created during the installation process. The Output name is used to identify which devices are included in the Output group. Physical devices (for example, Printer archives, diagnostic review workstations, etc.) are supported via Named Virtual Devices. These become the output destinations of the system and can be grouped together or used individually.

The Edit Outputs function adds or removes Outputs. A list of currently available choices appears in the dialog box and you can group destination devices into an output group, add new groups, delete, copy, or edit current ones. The external CD-RW drive and any network connections are setup at installation. They can be combined into additional group outputs.

Outputs are defined using the Edit Outputs Menu. This option enables you to:

- Select output destination(s) and add/subtract them from the output's device list.
- Select devices to be associated with each output destination(s).
- Save the output under a recognizable name.
- Create a new output list using an existing output list.
- Delete an output list.

In the Edit Outputs function, the lists of configured possible output destinations are sorted by device name:

- Archive = PACS and local storage devices
- CDRW = CD-RW
- Physician Display = diagnostic review workstation, technician review workstation, CAD
- Laser Camera = Printer

Other characteristics of output lists are:

- A single named virtual device that appears in multiple output lists has the same configuration in all those lists.
- At least one output list is named "No Outputs" and contains no devices.
- Named virtual devices appear in the Edit Outputs tool's destination list when the service engineer configures the device. An output for the virtual device appears in the output list when the device is added using the Edit Outputs function.



Note

Only Accepted Images are sent to the selected list of outputs. Rejected Images are sent to their own list of output devices and must be removed from the system after being reviewed.

18.5.1 Add a New Output Group



Figure 61: Edit Outputs Dialog Box

1. Select **Edit > Outputs**, and click **New** to add a new Output.

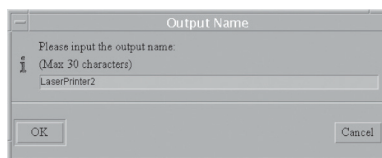

Figure 62: New Output Name Dialog Box

2. Enter the name you want to use for this Output (for example, LaserPrinter2) in the *Output Name* dialog box.

3. Click **OK**. The new name shows up in the *Edit Outputs* dialog box.

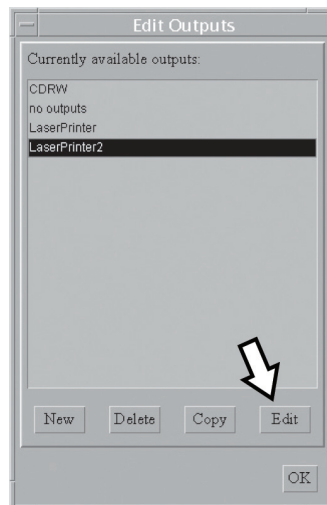

Figure 63: New Name in Edit Outputs Dialog Box

4. Select the new name (for example, LaserPrinter2) in the *Edit Outputs* dialog box, and click **Edit**.

The *Edit Output: <device name>* dialog box appears, with tabs for the four types of outputs. The Device names currently selected are listed in the right column.

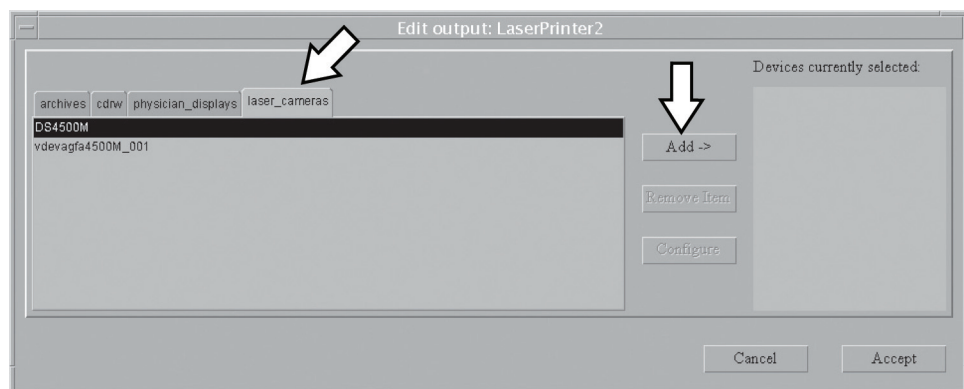

Figure 64: Adding Devices

5. Click the tab of the device type you need to add. The driver(s) for that type of output are listed.
6. Select the device you want to use.
7. Click **Add** in the middle of the box. The device name appears in the right column, *Devices currently selected*.
8. If you want to add an additional output, click the device tab for it.
9. Click the additional device you want to add.

- Click **Add** to move it to the right column. You can add many devices to a group.

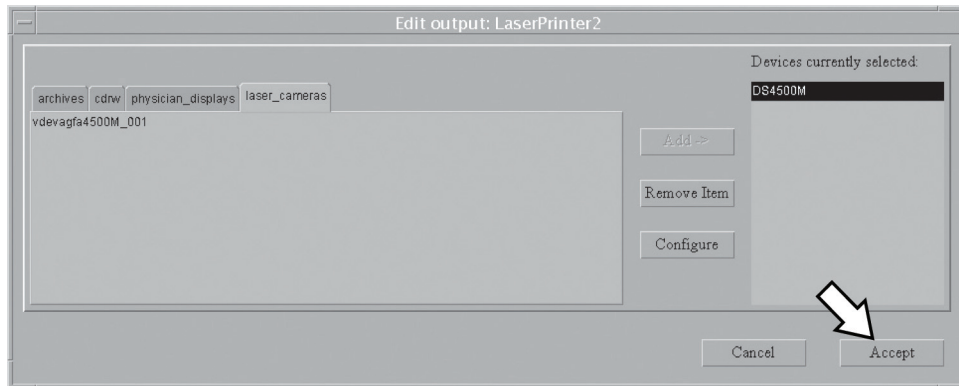

Figure 65: Configuring the Output Device(s)

- Click **Accept** to close the *Edit Output: <device name>* dialog box. The new group name shows up on the *Edit Outputs* dialog box.
- Click **OK** to close the *Edit Outputs* dialog box.

18.5.2 Edit Outputs and Make New Groups

To recombine devices or delete a device from a group:

- Select **Edit > Outputs**.
- Click an Output name(s) that you want to change or recombine.
- Click **Copy**. A dialog box appears.
- Enter the new Output name you want to use for this Output (for example, LaserPrinter3).
- Click **OK**. The new name shows up in the *Edit Outputs* dialog box.
- Select the new name, in this case LaserPrinter3, in the *Edit Outputs* dialog box.
- Click **Edit**. The *Edit Output: <device name>* dialog box appears, with tabs for the four types of outputs. Devices currently part of the group are listed in the right column.
- Click the tab of the device type to add, for example, `laser_cameras`. A list of the driver(s) for that type of device appears.
- Select the device you want to use.
- Click the **Add** button in the middle of the box. The device name appears in the right column, *Devices Currently Selected*.
- If you want to add an additional device, click the tab for it (for example, `cdrw` for a CD-RW drive).
- Click the additional device you want to add.
- Click **Add** to move it to the right column.

14. Click the name of any output in the *Devices Currently selected* column that you do not want in the group and click **Remove Item**.
15. Click **Accept** to close the *Edit Output: <device name>* dialog box.
16. Click **OK** to close the *Edit Outputs* dialog box.

18.5.3 Delete Outputs

To delete an output group name that is no longer needed:

1. Select **Edit > Outputs**.
2. Click the output name(s) that you want to delete.
3. Click **Delete**. The *Delete output?* dialog box appears.
4. Click **Yes** in the *Delete Output?* dialog box. The dialog box closes and the output name is removed from the *Currently available outputs* list.

18.5.4 Output Queues

Actual transmission to a given output device is handled through output queues associated with the device. The following conditions apply to output queues:

- Output queue states are held through shut down cycles.
- Output queues are automatically restarted in the same state as at shutdown.

An Admin Menu function (see *Manage Queues* on page 97) allows you to:

- Cancel jobs from queues (not including active jobs).
- View job status within queues.
- Resend "stopped" jobs. Note that images for problem jobs are not reclaimed.

18.5.5 Using the New Output in the Patient View Window

1. Click the **Outputs** down arrow.
2. Select the new name (for example, LaserPrinter2). A *Setup output devices* dialog box appears informing you that you are changing to the output <name> and listing the virtual device name(s) in the output.

3. Click **OK** to close the *Setup output devices* dialog box.

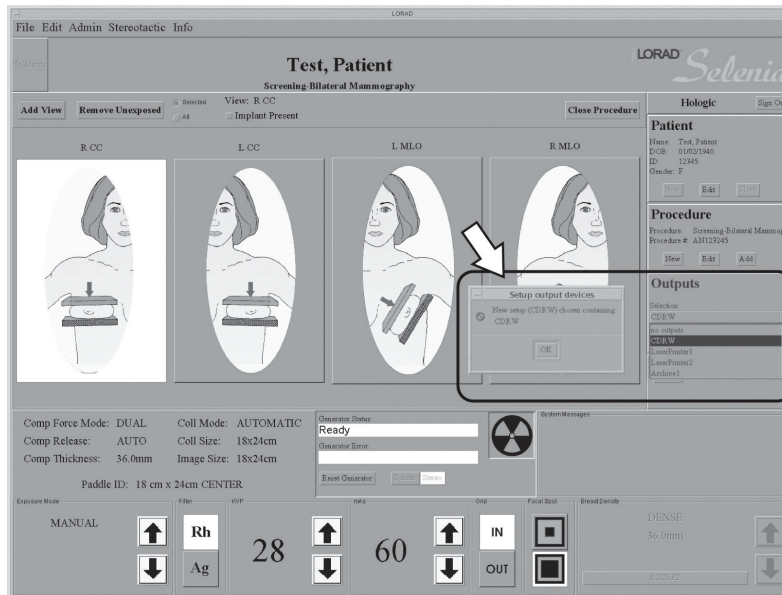

Figure 66: Choose Output

4. Click **OK** to close the *Setup Warning* dialog box.

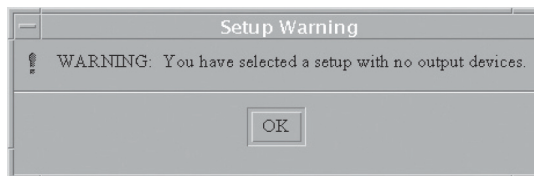

Figure 67: No Output Selected

The "no outputs" option is used by service when they do not need an output. If you choose this option, none of the images you acquire are sent to any other devices.

18.6 Data Storage (Using Outputs)

The Selenia data storage system is comprised of the following subsystem components:

- Acquisition Workstation hard drive (automatic save)—for acquisition, temporary storage, and QA display of the breast images
- CD-RW—for temporary storage of images on removable storage media

The Selenia System can interface with these components:

- Diagnostic Review Workstation—for display of diagnostic quality images
- Film Printer—for printing on high-resolution films
- Network Storage—for storing data, archiving images

The Selenia System, when connected to a network, can store data on many systems and can output to many others. These integrated systems are user selectable and location specific.

If you do not have a connection to a PACS system, you must send the patient information to an approved film printer.

18.6.1 Hard Drive

The Acquisition Workstation computer's hard drive automatically stores the Acquired Images. Select the Main Menu item **Admin>Available Disk Space** to display the available storage space remaining, in units of images, on the system. The capacity of the hard drive, about 50 Images per Gb, depends on the size of the images. A 24 x 29 cm image uses more storage space than an 18 x 24 cm image, so the number of available images is an estimate.

18.6.2 Automatic Reclamation of Hard Drive Space

The system automatically reclaims Hard disk storage space for new Procedures. Reclaiming is a process of deleting existing patient files from the Acquisition Workstation hard drive in order to make room for new patient information. The image reclaimer deletes images from the system when a number of images have accumulated on the system. Once reclamation of images begins, images continue to be reclaimed until the number of images on the system reaches a set number.

Some images are not deleted:

- No Patients are deleted if they have any Images queued to an output device.
- No Images are deleted for Protected Patients.
- No Images queued up on an output device are deleted.
- No Images that are not successfully committed to an archive device are deleted.
- Rejected Images are not automatically deleted.



Caution:

If the disk does not have enough available space, the system does not acquire an image. A message displays the capacity of the disk. Delete unneeded images to restore the disk space.

This message should appear only after messages alerting you that there are too many protected patients or too many images backed up on an output device, and so may be due to a configuration issue that can be corrected by service.

18.6.3 CD-RW Drive

A Compact Disc ReWritable (CD-RW) drive, mounted on the underside of the Acquisition Workstation, is available for temporary storage of images. If you do not have a PACS network connection, you must select an approved film printer as one of the outputs for patient images.

1. To use the CD-RW drive as an output, in the **Output** box of the **Patient View** window, select an output that includes the CD-RW. A **Setup Output Devices** dialog box appears, informing you that you have selected a new setup <name> and giving you the virtual device name for the CD-RW.
2. Open the drive drawer by pressing the **Eject** button on the drive.
3. Write the patient name, ID # and date on the envelope and/or CD. Insert the approved CD-R disk in the drive prior to starting a procedure.

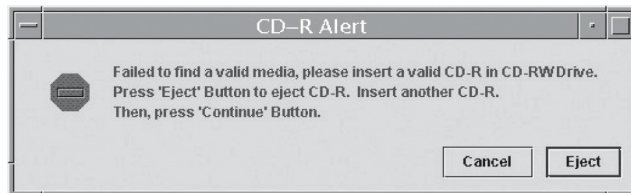

Figure 68: Invalid Media Alert

4. Select the CD-RW as an output, or part of an output group. Acquired images are now sent to the CD as well as to any other output in the group (if any).
5. After the last view is accepted, it takes a few minutes to finish writing the images to the CD (longer for 24 x 30 cm images).
 - Observe the **Jobs in Queue** message in the Outputs pane to tell when all the images are done.
 - You can use **Admin>Manage Queues** to see what is still in the Queues.
6. After the last view is sent, use **Admin>Eject** to eject the CD.

Writing images to a CD takes longer than saving or printing them. You can use the **Image Management>Resend** option and write them after the procedure is finished. This has the advantage of not slowing down the rest of the procedure while you are waiting for the program to write to the CD during Image Acquisition.

To see which patients/views are on a CD, use **Admin>Import**.

The CD-RW drive is also available for importing images from other Selenias recorded on a CD. Use the **Admin>Import** directions for Importing Images.

18.6.4 Change the Disk in the CD-RW Drive

If the disk is near capacity, the message below appears.



Figure 69: CD-R Alert

To change the CD:

1. Click **Eject** on the alert message dialog box and the CD-RW drive drawer opens.
2. Remove the full CD and insert a labeled blank one.
3. Close the drawer. Label the full CD and store it per local requirements.
4. Click **Continue** to save the remaining Images.

If you click **Cancel** and do not change the CD, the system generates an **Alarm** and does not archive the current Image on the CD. It is saved on the hard drive and you can **Resend** it from the **Image Management** function.

18.6.5 Film Printer

The system can send the Image to an optional high-resolution DICOM film printer. Details on the function of the printer depend on the printer. The printer configuration (as with any new printer) is setup by an authorized service engineer. You must add it to the Outputs list.

18.6.6 Network Storage

The system supports retrieval of the archived Images and Procedures. A separate diagnostic review workstation can retrieve the Images. Details on the function of these outputs depend on your specific configuration.

19.0 Admin Menu

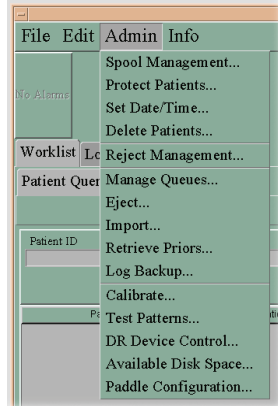

Figure 70: Admin Menu

19.1 Image/Spool Management

This Admin Menu item allows you to:

- Query for Patients whose Images are still within the Image spool.
- Resend selected images in the spool to Output Destination devices. (The system resends Images to the selected output exactly as found in the spool.)
- Repreview an Image; add comments, etc. (which generates a new image file).
- Confirm DICOM storage commitment.

Query details:

- Entering an incomplete string returns all matches to the string.
- Queries are not case sensitive.
- "No entry" or "*" is equivalent to everyone in the Image spool.
- If too many matches are found, the application requires more specific search criteria.
- If no matches are found, the message, "No Patients matching query" is displayed.
- When there are Images for the queried Patient(s) the Acquisition Workstation displays Patient information in a table.

When you have selected a patient to manage, an Image Management screen displays. The upper right pane displays detailed information about the view when you have selected a single view. This information includes the view name, acquisition capture timestamp, technologist, comments, and other data. The lower pane displays thumbnails of all the images of the selected Patient in the order of acquisition.

19.1.1 Using the Resend Options



Figure 71: Image Management Resend Options

1. Select a thumbnail image to resend.
2. The output selected when the image was acquired appears as the default. Confirm the Output is correct. If not, select the Output you want from the drop-down list. The Output change you make here does not affect the Output selection on the main screen.
3. If the selected Output has a printer, the following **Print Image Processing Options** appear. Click the option to select or deselect it.
 - Adjust the **Contrast** and **Density** for printing. Change by clicking another number to increase or decrease.
 - **Print True Size** (if available at the printer).
 - **Apply PCE** (the Peripheral Contrast Enhancement Function uses a special algorithm to enhance the appearance of the mammograms).
 - Omit Patient Name.
 - Omit Label options.
4. Click **Resend**. A dialog box states the number of images resent.

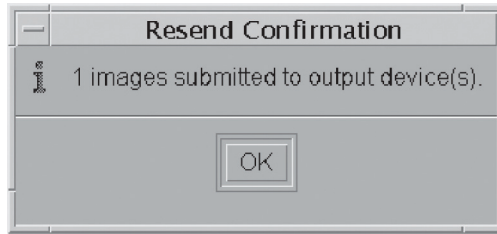

Figure 72: Resend Confirmation



Tip:

You cannot change any Patient or image object information from the resend function. This includes image, LUT modifications and DICOM information such as Patient name spelling, ID, comments, etc. The only way to send new information is to make a new file using the Repreview function, save it, and Resend this new file.

19.1.2 Using the Repreview Option

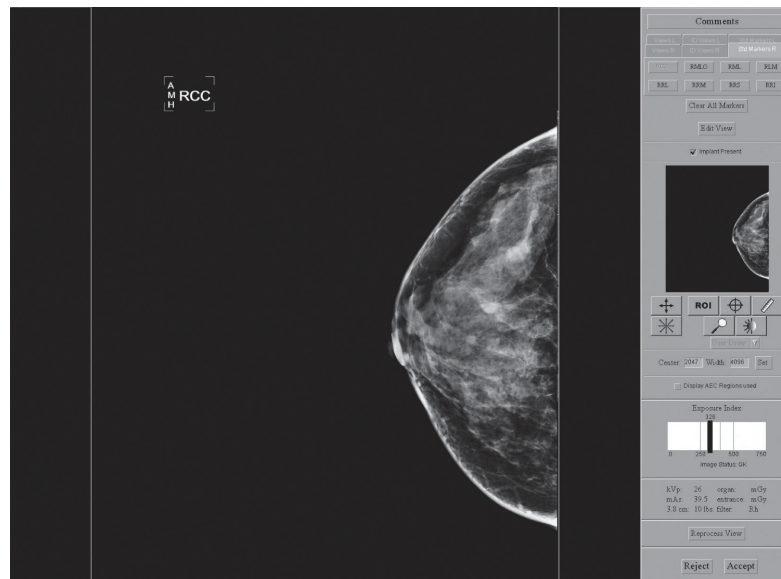

Figure 73: Repreview Screen

1. Select one Image thumbnail that you want to review. Use the arrows to scroll when more than four images are available.
2. Click the **Repreview** tab, then the **Repreview** button.
3. The Repreview screen appears with the same tools as you had in the Preview screen. If you only want to review the Image, click **Cancel** when you are done. If you select a FOR PRESENTATION image, you cannot change the markers and ROI is not available.

4. If you want to create a new file to resend, make any required changes to the markers, comments, or use the **Edit View** button and then click **Save**.
5. Make any necessary changes to the output selection. When the Send Image to Output dialog box displays, click **Yes** to send the images to the selected output group.
6. If you are reprinting, make any necessary changes in the **Contrast** or **Density**.
7. Click **Save**. The **Repreview** screen closes and the **Image Management** screen appears again. You have created a new copy of the original file.



Note

Be careful when resending that you send the newly saved image. The original is still there as a possible selection.

19.1.3 Correcting Incorrect View Selections with an Edit Button

One use for the Repreview function is to correct an incorrect view exposure if the error was not corrected before clicking **Accept**.

1. In the Repreview screen, select the **Edit View** button.
2. Select the correct view.
3. Select **OK**. The incorrect view is replaced with a corrected one.
4. Click **Save** to save the new version with corrected markers and orientation.
5. Select the Resend tab. Deselect the wrong image and select the last new thumbnail.
6. Select the correct output and select the **Resend** button. Click **OK** in the confirmation box and click **Close** to leave the Image Management function.
7. Delete the incorrect image sent to the chosen outputs.
 - If the image was printed, collect and discard the incorrect image.
 - If the image was sent to a diagnostic review workstation, log on and delete the incorrect image.
 - If the image was sent to the PACS, contact the PACS administrator and have them delete the incorrectly marked study.
 - A manager can delete the incorrect image. See *Delete Image Function* on page 126.

If your Preview Screen does not have an **Edit** button and you have accepted the image, see *You Do Not Have an Edit View Button* on page 58.

19.1.4 Other Options on the Image Management Screen

- Query for another Patient by clicking **Choose a New Patient**.
- Close the **Image Management** screen without taking any actions.

19.2 Protect Patients

This menu item protects or unprotects Patient's records on the Acquisition Workstation hard drive. The system cannot automatically reclaim Protected records.

1. Select **Admin>Protect Patients**.
2. Search for the Patient you want to protect and select the Patient from the search results.

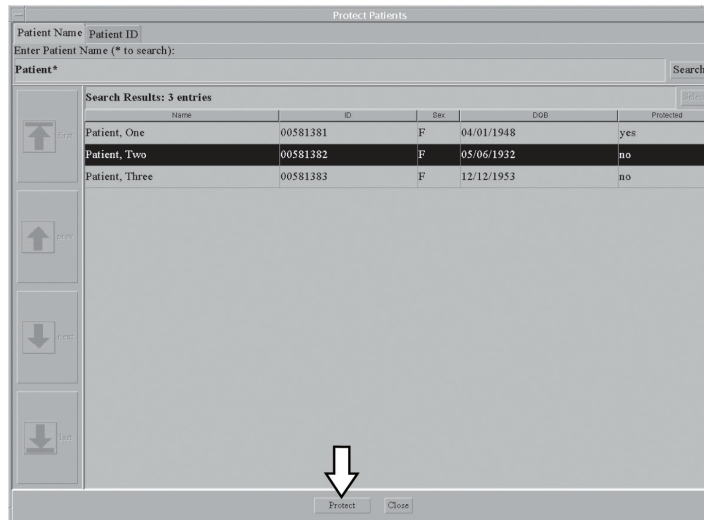

Figure 74: Protecting Patients

3. Click **Protect** at the bottom of the screen. A dialog box appears prompting you to confirm you want to protect the Patient. Select **Yes**.

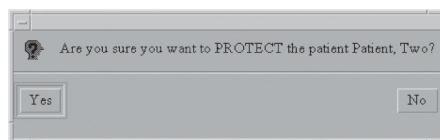

Figure 75: Protect Confirmation

To Unprotect a Patient:

1. When you no longer need to protect a Patient, select **Admin>Protect Patients**.
2. Select the name and click **Unprotect**.
3. Repeat for each patient who no longer needs to be protected.
4. Click **Close** to close the dialog box.



Note

Be sure to **Unprotect Patients** when you no longer need them to avoid filling up the Acquisition Workstation hard drive.

19.3 Manage Queues

Click Admin>Manage Queues to find problem jobs or locate a particular job in the queues.

Actual transmission to any output is handled through Output Queues. Each connected output device is associated with an Output Queue. If a physical device does not accept a job or if the job does not complete successfully, the job may be retried or held as a Problem Job, depending on the reason for the error.

A service configurable number of retries are performed before an alarm is generated. A service configurable number of retransmission attempts occurs after the alarm is generated. Once the alarm condition clears, the alarm must be erased to be cleared.

Jobs may fail because there is either a problem with a specific characteristic of the job (for example, configured LUT not available on the physical printer) or because there is a general problem with the physical device (for example, device is off-line). In order to keep Problem Jobs from clogging an otherwise operational queue with retries, the output queues have two levels of priority. The levels are managed automatically and there is no direct user interaction.

You can view the states of the output queue:

- Waiting—job has not made it to the top of the queue yet.
- Running—job is active.
- Sleeping—Error—job has an unresolved alarm that has continued for a configurable number of retries (see below).
- Stopped—Error—job has a non-recoverable alarm and is not being retried.
- Output queue states are held through shutdown cycles.
- Output queues are automatically restarted in the same state they were in at shutdown.



Note

Images for problem jobs are not reclaimed until the job is removed from the queue.

19.3.1 Job Retry Options

The Acquisition Workstation supports the following job retry actions. The parameters used in the action processing are service configurable, and the factory defaults are listed below.

- Number of failed retries before an alarm is posted (default = 3).
- Initial delay time between retries that occur after the alarm is posted (default = 90 sec.).
- Number of failed retries using the initial delay time (default = 10).
- Final delay time between retries (default = 900 seconds) Note: This feature helps to prevent failed jobs from "clogging" the queue.
- Total number of retries attempted after an alarm has been posted until the job is marked "Stopped," and retries are discontinued.

19.3.2 Available Manage Queues Functions

You have the following functions (see the numbers to the left of the figure below):

1. *A list of available queues.* Different spoolers may have been configured to handle different communication services.

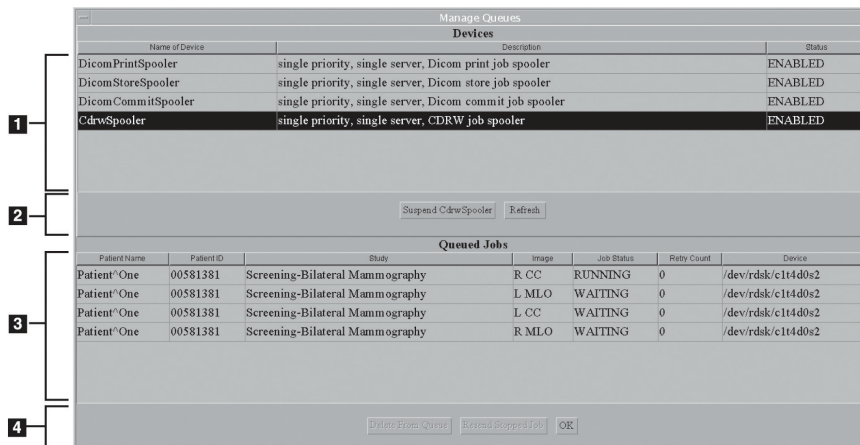

Figure 76: Manage Queues Suspend Job Spooler button

2. *Two buttons under the list of available queues*
 - A **Suspend Job Spooler** button that suspends images from going to the selected queue. This changes the current state from Enabled to Suspended.
 - A **Refresh** button that refreshes the queued jobs list for the selected device.
3. *A scrolling list of queued jobs.* This list identifies all of the jobs in the queue by:
 - Patient Name
 - Patient ID
 - Study
 - Image
 - Job Status: Running, Waiting, Problem, Sleeping
 - Retry Count
 - Device
4. *Selecting an inactive job from the list, activates buttons that allow you to:*
 - Delete a job from the queue.
 - Resend a job, if the job is in the stopped status.

You cannot delete currently Active jobs from the queue, and the **Delete Job** button is not active if you select such a job. If a job is stopped, the **Resend Stopped Job** button becomes active.

You may delete all jobs the system is not currently sending from the queue regardless of who originally queued it.

19.3.3 Using Manage Queues

Click **Admin>Manage Queues** to check for problem jobs or locate a particular image in the queues.

19.3.4 Determine the Status of a Job

- Click the queue you want to view in the Devices list.
 - The jobs in that queue are listed in the **Queued Jobs** list.
 - Their status is in the **Job Status** column.
 - A status of "sleeping" means a job has been retried several times in a row and is currently suspended for an hour or so before retrying.
- Click **OK** when you are finished.

Manage Queues						
Devices						
Name of Device	Description				Status	
DicomPrintSpooler	single priority, single server, Dicom print job spooler				ENABLED	
DicomStoreSpooler	single priority, single server, Dicom store job spooler				ENABLED	
DicomCommitSpooler	single priority, single server, Dicom commit job spooler				ENABLED	
CDRWSpooler	single priority, single server, CDRW job spooler				ENABLED	
<input type="button" value="Suspend CDRWSpooler"/> <input type="button" value="Refresh"/>						
Queued Jobs						
Patient Name	Patient ID	Study	Image	Job Status	Retry Count	Device
Patient One	00581381	Screening-Bilateral Mammography	R CC	RUNNING	0	/dev/rdisk/c114d0s2
Patient One	00581381	Screening-Bilateral Mammography	L CC	WAITING	0	/dev/rdisk/c114d0s2
Patient Two	00581382	Screening-Bilateral Mammography	R CC	WAITING	0	/dev/rdisk/c114d0s2
<input type="button" value="Delete From Queue"/> <input type="button" value="Resend Stopped Job"/> <input type="button" value="OK"/>						

Figure 77: Delete Selected Jobs in a Queue



Warning:

When you select Delete Job, the job is permanently deleted. If you did not send the job, resend it to a storage device later.

19.3.5 Delete (Canceling) a Job

- Click the queue you want to manage in the Devices list.
- Click the **Suspend <name> Spooler** button.
- Select a job from the **Queued Jobs** list, or Ctrl+Click to select multiple jobs. Verify the job(s) you want to delete are selected correctly. There is no "undo".
- Click the **Delete From Queue**—below the list.
- Click **OK** when you are finished.

19.3.6 Resend a Stopped Job

1. Click the queue you want to manage in the **Devices** list.
2. Select a job or jobs labeled 'Stopped' from the **Queued Jobs** list.
3. Verify the job(s) are selected correctly.
4. Click the **Resend Stopped Job** button—below the list.
5. Click **OK** when you are finished.

19.4 Eject



Note

The drive drawer only opens from the menu when there is a disk in the drive.

Click **Admin>Eject** to open the CD-RW drive drawer when there is a disk in the drive. If there is no media in the CD-RW drive, clicking Eject in the menu results in a CD-R alert window informing you there is no media in the drive. Press the button on the CD-RW drive to open the drawer. To close the drive, in either case, press the CD-RW drive button.

19.5 Import

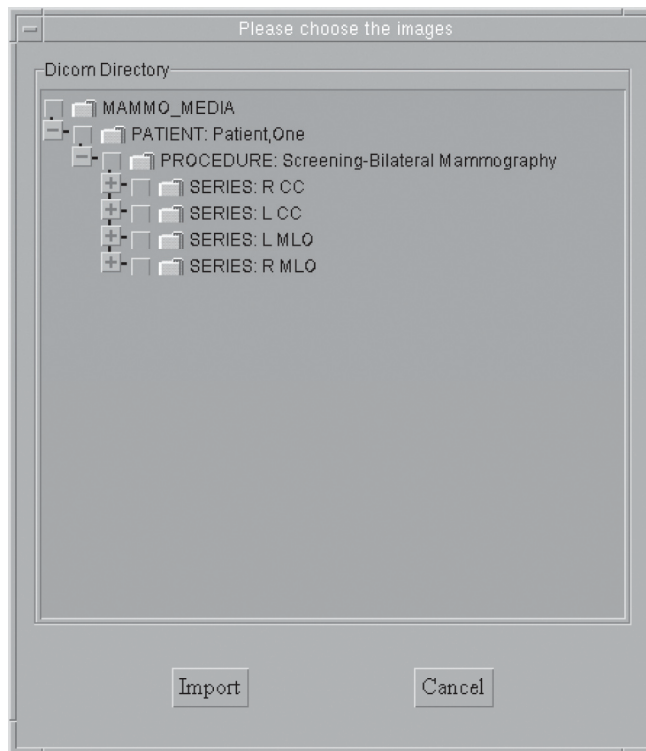

Figure 78: The Import Dialog Box



Note...

Do Not press the **Eject** button on the drive while the system reads from or writes to the disk. It may cause the drive to stall.

Imported images can be reviewed and sent to outputs including store-committing them.

1. With the CD containing the images to import in the drive, select **Admin>Import** to import a DICOM Image file from a CD. A dialog box appears and the system reads the CD in the drive. The Patient's name displays in the list.
2. In the dialog box, find the file(s) you wish to import.
 - Clicking on a "+" opens a list of folders and/or files below.
 - Clicking on the empty box selects the file or folder.
 - Click the file name and a check appears in front of all files you have selected. Alternately, click a folder to see the list of files in the folder. If you click the box in front of the folder, you select all the files in the folder. All checked files are imported.



Tip:

If you have selected a file that you do not want to import, click the check mark again to clear it. Clicking on a folder selects all subfolders below it. Re-clicking on the folder unselects the folder, but does not unselect all the files below it. You have to clear each one.

3. Click **Import**. A dialog box indicates the progress of the import.
4. Click **Cancel** to close the dialog box without importing anything.

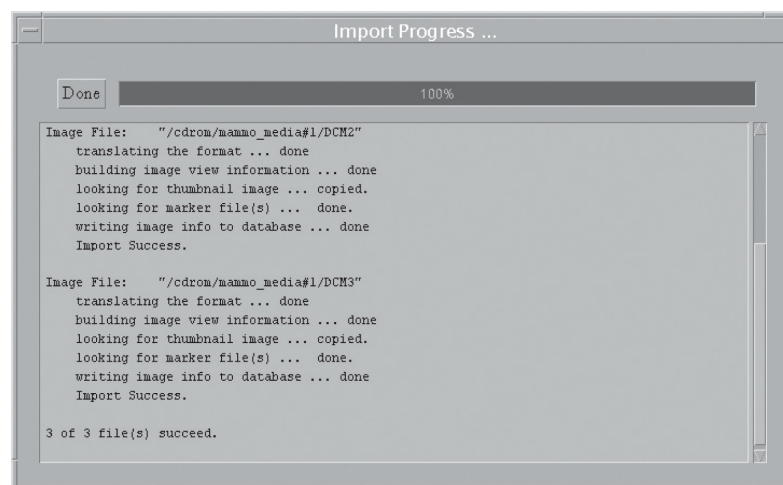

Figure 79: Import Progress Dialog Box

5. The **Import Progress** dialog box indicates the files imported and whether the import is successful or not.

The imported Patient data is available in the **Select a Patient** screen.

19.6 Retrieve Priors

All users have the ability to view prior Images on the Acquisition Workstation if the Images are in the Local Database or stored on the PACS system. Locate Images in the Local Database by clicking on the Local Exams tab and searching for the Patient.

Images on the PACS require an additional step. The Selenia system queries and retrieves the prior Images for a Patient from the PACS system. The program asks you to choose the source if more than one source has been configured.

The system imports Images into the Acquisition Workstation Local Database. Images already on the Acquisition Workstation generate an alarm if you try to overwrite them with the PACS version.

The rules for handling both FOR Processing and FOR Presentation retrieves of the same image are:

1. If the image being retrieved is a for processing image and is already present in its for processing form in the database, you are alerted to the fact that the image is already in the database, and therefore, the import of that image did not occur.
2. If the image being retrieved is a for processing image and the for presentation version is already in the database, you are alerted to the fact that the image is already in the database, and therefore, the import of that image did not occur.
3. If the image being retrieved is a for presentation image and it already exists as a for presentation image in the database, you are alerted to the fact that the image is already in the database, and therefore, the import of that image did not occur.
4. If the image being retrieved is a for presentation image and the for processing version is already in the database, then the data for the for processing version should be discarded and replaced with the for presentation version. The log file notes this replacement activity.
5. After the import is completed, the Patient can be opened using the Completed Exams tab and located like any Patient captured on the Acquisition Workstation. Any import errors are displayed as Alarms.

To Retrieve Priors from the PACS system:

1. Click **Admin > Retrieve Priors**. The **Retrieve Priors** screen appears.
2. Search for the Patient's name in the **Name** field or ID in the **ID** field (wildcards are allowed).

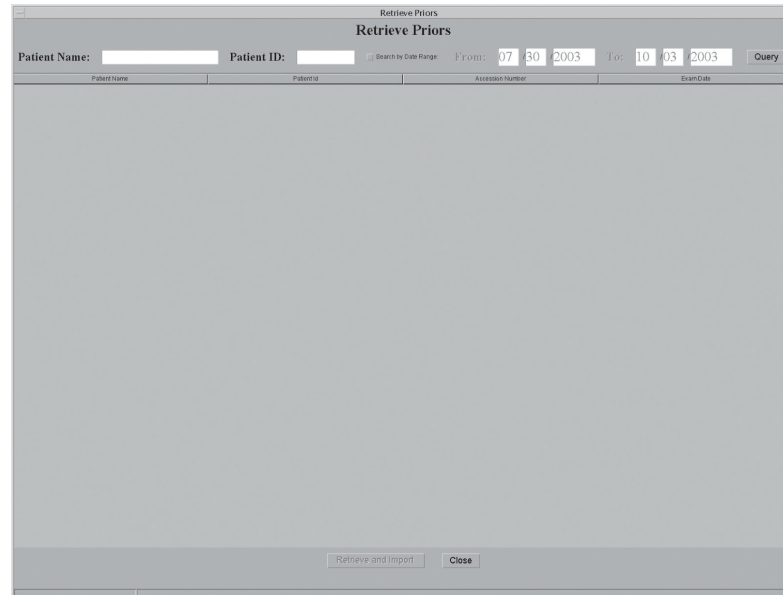

Figure 80: Retrieve Priors Screen

3. After searching the PACS system, the program displays a list of all Patients meeting the query criteria (Number 1, in the figure below). The progress bar on the lower left (Number 2, in the figure below) indicates the system is busy searching.
4. Select the Patient name(s) you want to import. Selecting a Patient activates the **Import** button.
 - You can choose several Patients at once.
 - Clicking a selected Patient deselects them.
 - The title bars allow sorting by field.
5. Click **Retrieve and Import** (Number 3, in the figure below). The PACS system locates the Images and imports them into the Acquisition Workstation Local Database. A dialog box appears and the progress bar indicates the status of the import.
6. Click **OK** to close the dialog box.
7. Click **Close** to close the Retrieve Priors screen and return to the standard acquisition screens while Import operates in the background.

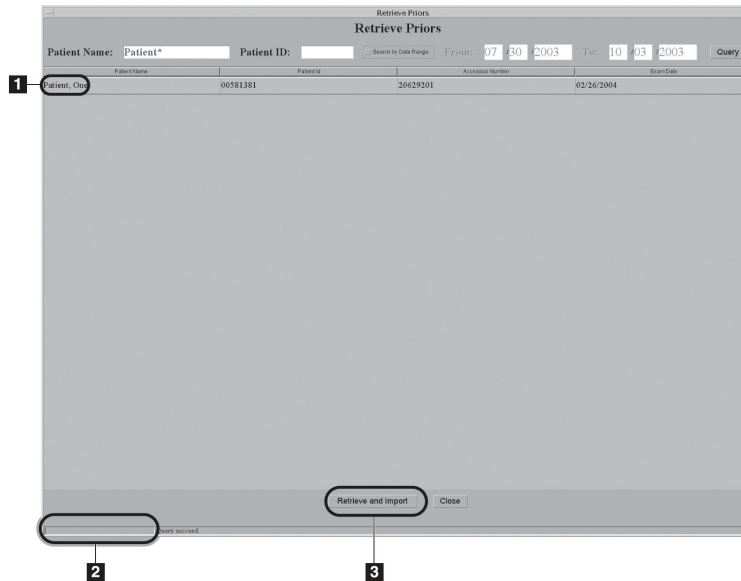

Figure 81: Results of the Retrieve Priors Query

Figure Legend

1. List of Patients
2. Import Progress Bar
3. **Retrieve and Import** Button



Figure 82: Image Import Started

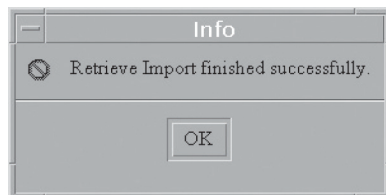

Figure 83: Query Retrieve Import Successful Dialog Box

After the import is completed, you can display the Patient Images using the Local Exams tab in the same method as any Patient Image acquired on the Acquisition Workstation. Alarms display any import errors.

If your query request resulted in more than 50 records, this dialog box appears. Refine your search.

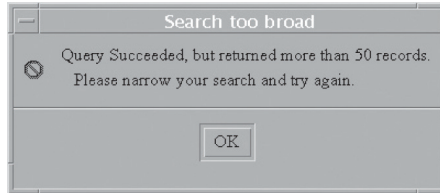

Figure 84: Search too Broad Dialog Box

If there are errors in the results of the query, this error dialog box appears.

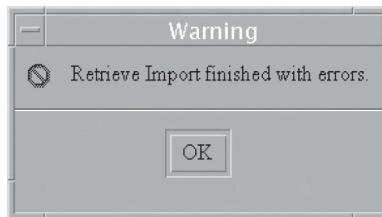

Figure 85: Query Retrieve Errors dialog Box

19.7 MPPS Status

An optional feature available for sites with an MPPS Service Class Provider. When this feature is installed, workflow changes with three close procedure button options instead of one. Adding a procedure and starting a new procedure also have slightly different functionalities.

19.8 Test Patterns

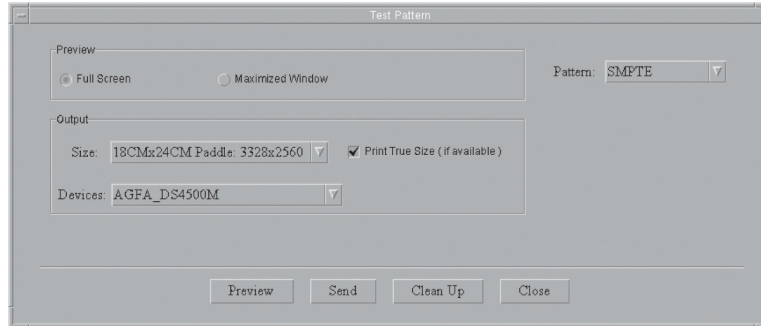

Figure 86: Test Patterns Dialog Box

Selecting **Admin>Test Patterns** displays a **Test Patterns** dialog box. Use Test Patterns for the Laser Printer Test (make different selections for other uses). Refer to the QC manual for details about the test.

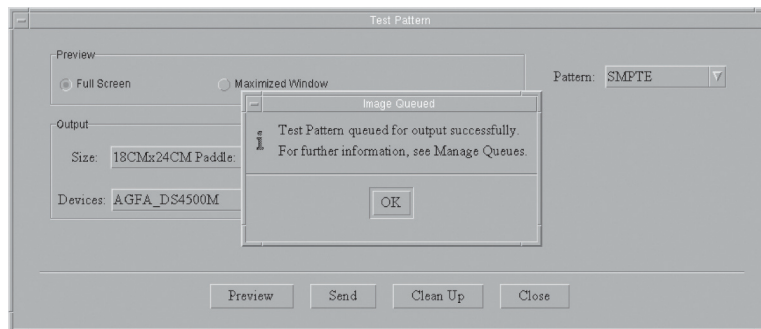

Figure 87: Image Queued Dialog Box

When you send the test pattern to the printer you get an Image Queues dialog box. To see where the image is in the queue, see *Manage Queues* on page 97.

The **Clean Up** button is for use if the system is having problems with disk space or reclamation warnings. Click on it to clean up any files from previous "test pattern sends" before sending the current image.

19.9 Available Disk Space

The available storage space remaining is indicated in units of images. This information is displayed on the window by selecting **Admin>Available Disk Space**. The capacity of the hard drive, about 50 images per Gb, is dependent on the size of the images. A 24 x 29 cm image uses more storage space than an 18 x 24 cm image.

20.0 Info Menu

The Info menu identifies the Acquisition Workstation software version. The screen displays current temperature of the detector, and the temperature, date and time of the last calibration. It also provides the maximum temperature the detector has reached and date and time this occurred.

Chapter 4 System Hardware Details

1.0 System Power Controls

1.1 Acquisition Workstation Circuit Breaker

Location of Circuit Breaker	Detailed Description
	<p>The Acquisition Workstation Circuit Breaker is found on the back of the system behind the shield. The Value Console Circuit Breaker (not shown) is found on the back of the Console. Do not normally turn the circuit breaker off. Use the circuit breaker only in an emergency, because the UPS power is removed and its battery begins to discharge. This can result in data loss.</p> <p>If you use the circuit breaker, wait until the UPS does not make a beep to turn the circuit breaker back On. The system automatically restarts, but the UPS might not respond automatically and then you must reset it.</p> <p>See <i>Uninterruptible Power Supplies (UPS)</i> on page 110 for directions.</p>

Figure 88: Acquisition Workstation Circuit Breaker

1.2 Gantry Circuit Breaker

Location of Circuit Breaker	Detailed Description
 <p data-bbox="380 695 748 722"><i>Figure 89: Gantry Circuit Breaker</i></p>	<p data-bbox="971 401 1427 642">The Gantry circuit breaker is found at the lower right corner of the back panel. It provides overload protection and removes power from the Gantry only. It should be used only to remove power for servicing or in an emergency.</p> <p data-bbox="971 648 1427 1033">Up is On and Down is Off. When the circuit breaker is used to turn off the Gantry, the system needs to be restarted. If the Acquisition Workstation is off, restart the system normally. If a Panel Power dialog box appears on the Acquisition Workstation, follow the procedure in the <i>Instructions for Use</i> to restart the system.</p>

1.3 Uninterruptible Power Supplies (UPS)

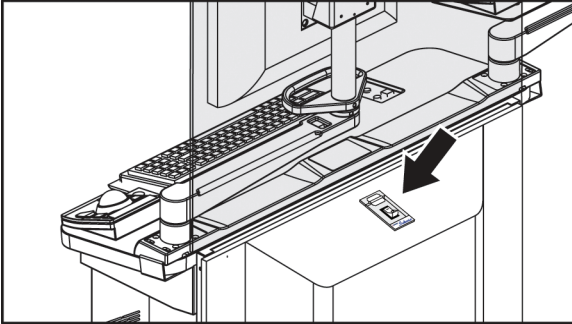
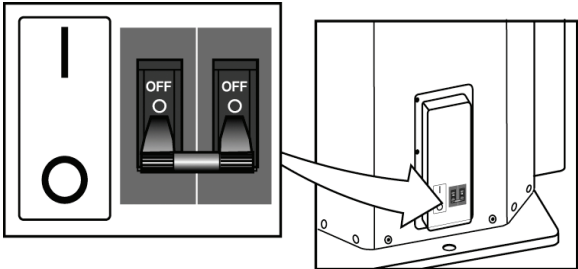
When there is no power to the system, the Value Console or the Acquisition Workstation and TechMate automatically begin to shut down. (For example, if the site has a power failure or if a Main power supply circuit breaker is shut off.) When power is lost, an ordered shutdown begins after approximately two minutes. This shutdown must be allowed to complete before the UPS is turned Off. Then both UPS systems chirp repeatedly and can be shut down until the power is restored. Refer to the *Instructions for Use* manual for UPS directions.

If the Acquisition Workstation or the TechMate does not respond to the **Power** button, its Uninterruptible Power Supply (UPS) may need to be reset.

For example: If power is removed from the Acquisition Workstation (such as power source disconnected or circuit breaker switched off) and then re-applied, the UPS may not automatically respond.

In rare situations the Acquisition Workstation or Value Console computer can become locked up (unresponsive to user input) and must be turned off and restarted. In some cases the UPS can also require a reset.

2.0 Controls and Displays

2.1 Compression Device Controls and Displays

Figure Legend

1. Compression Handwheels.
2. AEC Sensor Position controls.
3. AEC Sensor Position Display.
4. Compression Force Display shows the compression force through the range of 10 lb \pm 1 lb to 67.4 lb (44.5 N to 300 N) in 1 lb (4.4 N) increments. Dashes are shown for force less than 10 lb.
5. Compression Thickness Display shows the thickness between 0 and 15 cm above the image receptor in 0.1 cm increments.

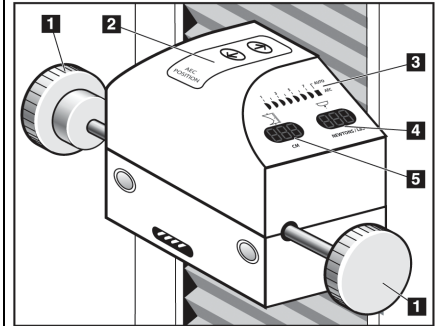

Figure 90: Compression Device

2.2 Dual Function Footswitches



Warning:

Put both footswitches away from the patient and C-Arm area to prevent any accidental footswitch use. When the patient has a wheelchair, put the footswitches away from the area.

The system incorporates two footswitches for C-arm and Compression Up/Down movement. Locate the footswitches for easy access from either side of the C-arm.

Figure Legend

1. C-arm Down
2. C-arm Up
3. Compression Down
4. Compression Up

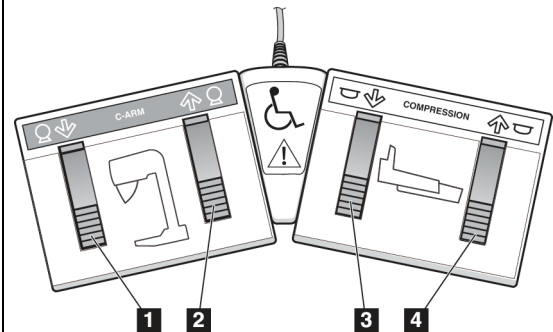
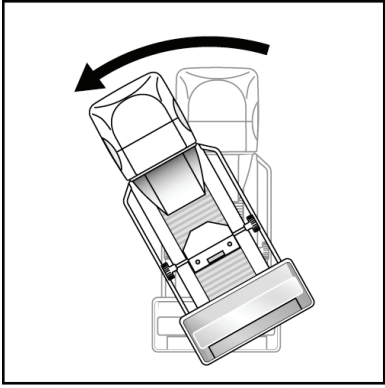
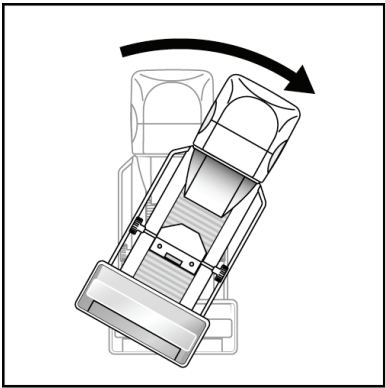
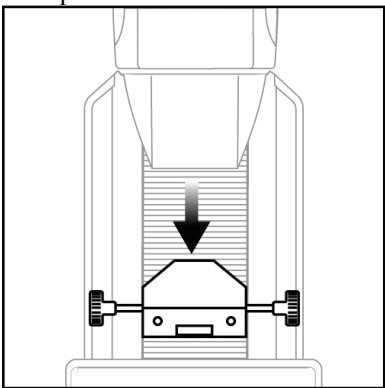
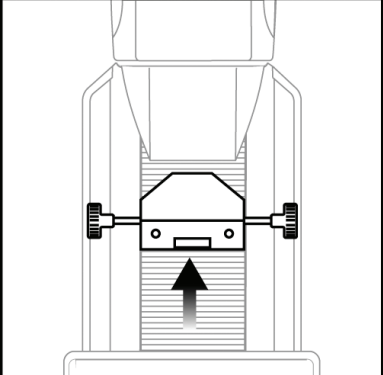
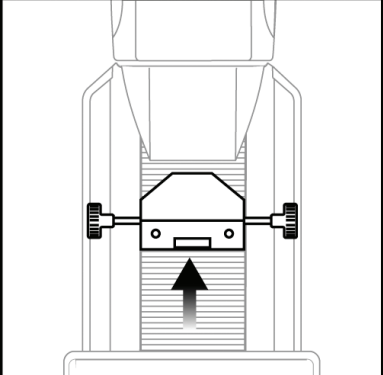
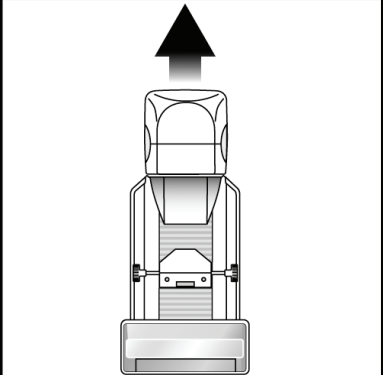
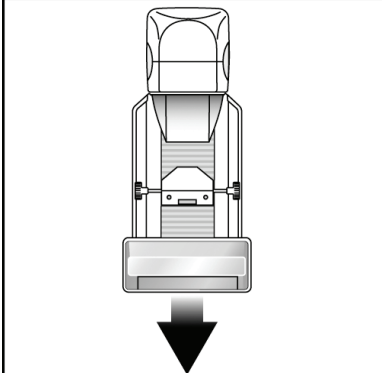
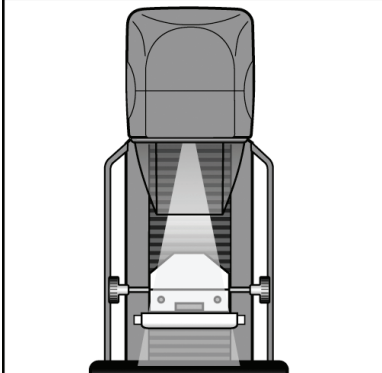
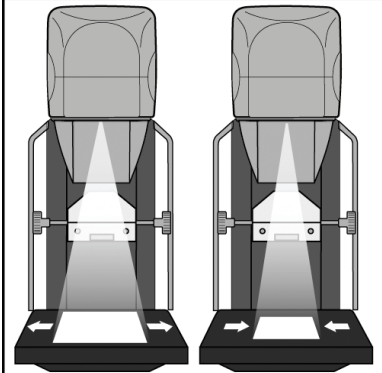

Figure 91: The Dual Function Footswitch

2.3 C-Arm Controls

Function	Detailed Description
<p>Counterclockwise C-arm Rotation</p> 	<p>When you press a C-arm Rotation switch, rotation commences immediately and ceases when you release the switch. Press this button to begin motorized counterclockwise C-arm rotation.</p> <p>C-arm movement is disabled when compression force of 58 N (13 lb) or greater is applied.</p> <p>The C-arm Angle Rotation Displays on the Gantry reflect the changes in rotation. Rotating the C-arm counterclockwise changes the display to a more negative reading.</p> <p>After making an oblique exposure, the C-arm angle is stored in memory . When you rotate the C-arm past 0 degrees for the next exposure, the system automatically stops the C-arm at the opposite oblique angle. When you press a Gantry Rotation switch, rotation commences after a short delay and stops after a pre-programmed amount of travel. Service configures the rotation detent position for the Gantry switches from 10-100 degrees of rotation; the default is 45 degrees.</p> <ul style="list-style-type: none"> • Press and hold a Gantry Rotation switch; audible beeps indicate the C-arm is about to move, then movement starts. Movement stops when the pre-programmed rotation angle is reached • Press the center button and the C-arm moves to the zero degree position.
<p>Clockwise C-arm Rotation</p> 	<p>Pressing a Compression Down button:</p> <ul style="list-style-type: none"> • Engages the compression brake . • Turns on the light field lamp. • Lowers the compression device. <p><i>Note... Once activated, the compression brake remains engaged until compression release is pressed.</i></p> <p>Compression down movement stops:</p> <ul style="list-style-type: none"> • Upon release of the button. • At the compression down force limit. • At the lower compression travel limit.
<p>Compression Down</p> 	

Function	Detailed Description
<p>Compression Up</p> 	<p>Pressing a Compression Up button:</p> <ul style="list-style-type: none"> • Raises the compression device. • <i>Does not</i> release or activate the compression brake. <p>Motorized compression up movement automatically stops:</p> <ul style="list-style-type: none"> • Upon release of the button. • Upon reaching the upper compression travel limit.
<p>Compression Release</p> 	<p>Pressing the Compression Release button:</p> <ul style="list-style-type: none"> • Releases the compression motor brake. <p>Raises the compression device approximately 10 cm.</p> <p><i>Note The system disables all compression release functions when a localization paddle is installed (including automatic compression release, if enabled.) Patient release is available through the compression up functions.</i></p>
<p>C-arm Up</p> 	<p>Pressing this button moves the C-Arm up. Motorized C-arm movement automatically stops upon release of the button or upon reaching the upper C-arm travel limit.</p> <p>C-arm movement is disabled when compression force of 58 N (13 lb) or greater is applied.</p>

Function	Detailed Description
<p>C-arm Down</p> 	<p>Pressing this button moves the C-Arm down. Motorized C-arm movement automatically stops upon release of the button or upon reaching the lower C-arm travel limit. C-arm movement is disabled when compression force of 58 N (13 lb) or greater is applied.</p>
<p>Light Field Lamp</p> 	<p>Pressing the Light Field Lamp button turns on the light field lamp for approximately 30 seconds, permitting you to visualize the x-ray field. The light field lamp automatically turns on whenever a Compression Down button is activated.</p>
<p>Collimator Override</p> 	<p>The Collimator Override button allows the collimator to cycle through the available calibrated x-ray fields. Choice of the collimator mode, Automatic or Manual, is made in Edit>Standard Setup. Press the Light Field Lamp button to visualize the x-ray field, and then press the Collimator Override button. The collimator device moves to another field size and the light field size changes.</p>

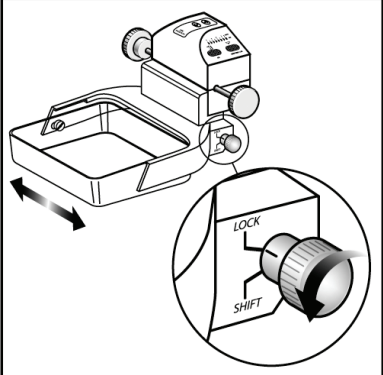
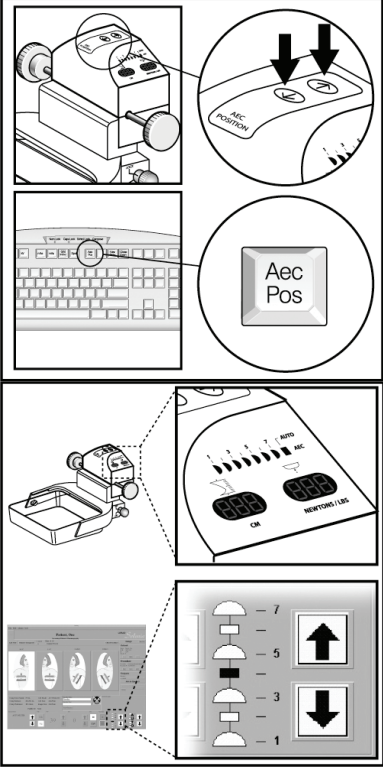
Function	Detailed Description
<p>Smart Paddle System</p> 	<p>Smart Paddles shift ~2.5 cm into a left, center, or right position. While compression is applied, the paddle cannot be unlocked. The collimator is programmed to follow the position of the Smart Paddles.</p> <ol style="list-style-type: none"> 1. Rotate and hold the knob on the side of the paddle to shift the paddle into one of the detent positions. 2. Move the paddle into the correct position. 3. Release the knob to lock the paddle in place.
<p>AEC Position</p> 	<p>Change the AEC Position by:</p> <ul style="list-style-type: none"> • pressing one of the arrows on the compression device top • using a function key at the Acquisition Workstation or Value Console • selecting an up/down arrow on the display <p>The AEC has an Auto setting. Move the AEC position beyond #7 or #1. The Auto position indicator on the compression device illuminates and the Acquisition Workstation display indicates Auto.</p>

3.0 Operator Radiation Shield

The system's radiation shield is permanently mounted on the Acquisition Workstation or the Value Console.

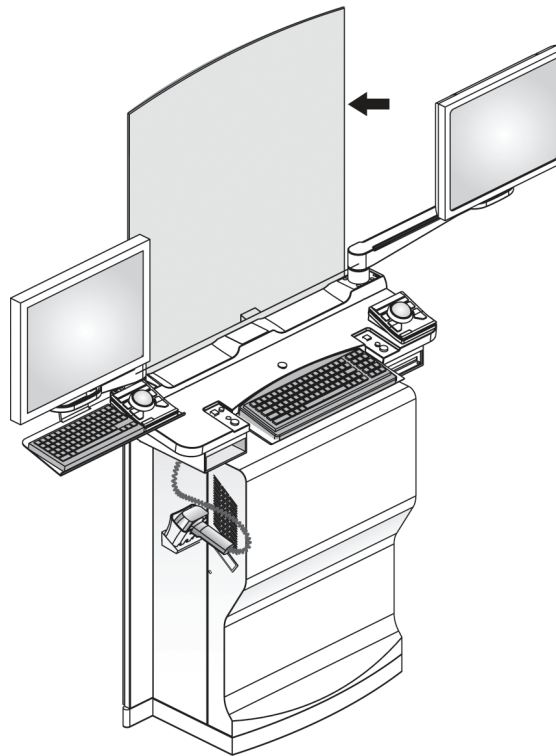

Figure 92: AWS Radiation Shield

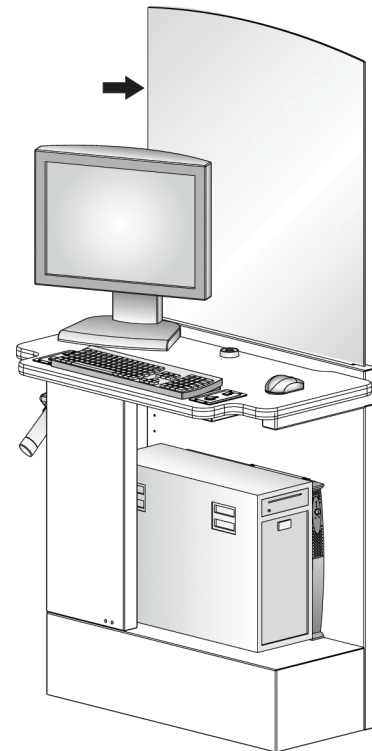

Figure 93: Value Console Radiation Shield

4.0 Background for the VOS Switch on the Mobile Selenia

Switches located in the Gantry limit the C-arm vertical travel to a pre-defined range. When the C-arm reaches its highest or lowest point of normal travel, the switches engage to stop further motion. If the C-arm should travel past the Limit switches (in the event of switch failure or other electrical malfunction), a second switch engages that removes power from the system. A Field Engineer would normally be contacted to repair and restart the Selenia.

In a mobile environment (during transport), it is possible for the C-arm to 'creep' downward and beyond the two Limit switches. If this occurs, the Selenia would be disabled—the lower limit switch would engage, preventing the system from normal start-up. This is not a failure condition that would require a Service Engineer's attention. The Vertical Position Override Switch is used to allow the operator to start the system and raise the C-arm to within its normal working limits.

Chapter 5

The Manager Functions

1.0 User Identification

The Acquisition Workstation first identifies the user at the login process with these Operating System (OS) and User Accounts:

- *tech* - a single x-ray technologist user account, a group log in for all technologist users.
- *mgr* - a manager user account for the Acquisition Workstation system administrator.
- *phys* - a medical physicist user account with special tools for the physicist.

1.1 User Assignments

When logged into the Acquisition Workstation, each individual user views a consistent set of screens saved by the OS for them. The OS user login determines which access level a user has to the Acquisition Workstation functionality. When the OS user is *tech*, *mgr*, or *phys* an Acquisition Workstation **Login to system** dialog box appears.

The manager configures user login information. The Acquisition Workstation maintains both user identity and passwords in a file. The user logs in by selecting from a list of users. The password is typed in and must contain at least six characters. These designators identify the individual who acquired the images.

A user can be assigned more than one OS access level and thus have their application sign-in appear at more than one level. For example, the manager may configure the following user identifications:

- Chief - both *tech* group and *mgr* user
- King - *mgr* group
- Joe - *tech* group
- Mary - both *tech* group and *mgr* user
- Sally - *tech* group
- John - *phys* group

The technologists identified by "Chief" and "Mary" may log in as either the OS user of *tech* or *mgr*. Their IDs appear in the User Identification list in either case. Depending on which OS login they are under, they may perform either normal tech functions or manager functions. The technologists identified as "Joe" and "Sally" only appear when the OS login is *tech*, and they have only normal tech level access to the Acquisition Workstation. The technologist identified as "King" only appears when the OS login is *mgr*, and "King" only has mgr level access to the Acquisition Workstation. The physicist identified as "John" only appears when the OS login level is *phys*.

2.0 Main Menu Functions

The Main Menu functions are always available except when a dialog box is presented. The table below indicates the state of the Main Menu functions for the *tech* and *mgr* OS users when a Patient/Procedure is **not** selected—*italics* indicates that the button is visible but inactive. Your logon level determines the availability of some Main Menu functions.

Table 9: Main Menu Functions by User (Patient/Procedure Not Selected)

Menu Function	Tech	Mgr
File	Exit	Exit
Edit	Standard Setup	Standard Setup
	View Order Editor	View Order Editor
	User Setup	User Setup
	Outputs	Outputs
Info	About the Acquisition Workstation	About the Acquisition Workstation
Alarms	Alarms	Alarms
Procedure Buttons	Sign Out	Sign Out
	Search	Search
	Patient (New/Edit/Close)	Patient (New/Edit/Close)
	Procedure (New/ Edit/Add)	Procedure (New/Edit/Add)
	Outputs	Outputs
	Non-Imaging Mode	Non-Imaging Mode
	Simulate Capture	Simulate Capture
Review	Review	

The **Close** button in the Patient box, active only when you have the Choose a Procedure window displayed, enables you to close the Choose a Procedure window without opening any procedures.

These Main Menu functions are available when a procedure is open. **Bold** indicates operational. *Italics* indicates visible but inactive.

Table 10: Main Menu Functions by User (Patient/Procedure Selected)

Menu Function	Tech	Mgr
File	Exit	Exit
Edit	Standard Setup	Standard Setup
	View Order Editor	View Order Editor
	User Setup	User Setup
	Outputs	Outputs
Admin	Image Management	Spool Management
	Protect Patients	Protect Patients
		Set Date and Time

Table 10: Main Menu Functions by User (Patient/Procedure Selected)

Menu Function	Tech	Mgr
		Delete Patients
		Reject Management
	Manage Queues	Manage Queues
	Eject	Eject
	Import	Import
	Retrieve Priors	Retrieve Priors
		Log Backup
	Calibrate	Calibrate
	Test Patterns	Test Patterns
	DR Device Control	DR Device Control
	Available Disk Space	Available Disk Space
		Paddle Configuration
Info	About the Acquisition Workstation	About the Acquisition Workstation
Alarms	Alarms	Alarms
Procedure Buttons	<i>Sign Out</i>	<i>Sign Out</i>
	Close Procedure	Close Procedure
	<i>Patient (New/Edit/Close)</i>	<i>Patient (New/Edit/Close)</i>
	Procedure (New/Edit/Add)	Procedure (New/Edit/Add)
	Outputs	Outputs
	Non-Imaging Mode	Non-Imaging Mode
	Simulate Capture	Simulate Capture
	Review	Review
	Add View	Add View
	Remove Unexposed	Remove Unexposed
	Implant Present	Implant Present

3.0 Edit Menu—Mgr Level

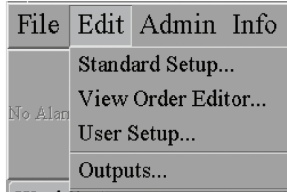

Figure 94: Edit Menu

Table 11: The Edit Menu for mgr Logon

Menu Item	Where item is discussed
Standard Setup	<i>Standard Setup Screens</i> on page 80
View Order Editor	<i>View Order Editor</i> on page 120
User Setup	<i>User Setup—Add or Edit a User</i> on page 82
Outputs	<i>Set Up Outputs</i> on page 83

3.1 View Order Editor

This Edit Menu item is only available to the Mgr login. It sets the site’s default View Order. This is the order the Views appear if they are not reordered by the technologist.

Each technologist can determine their own View order for performing a procedure. If they have set a View order, their setting determines their View order.

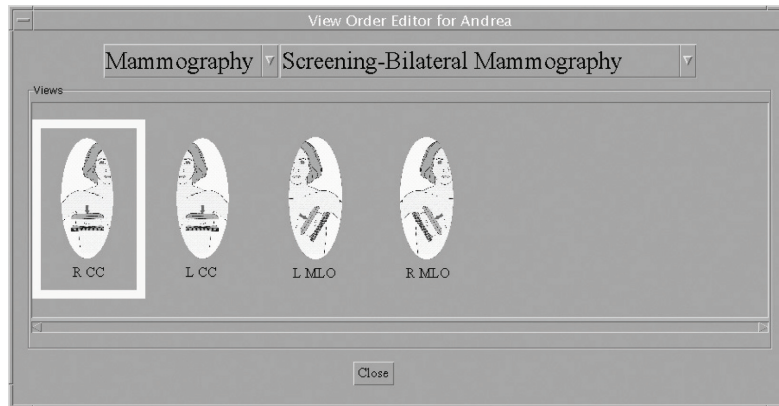

Figure 95: View Order Editor

4.0 Admin Menu Functions—"mgr" User Level

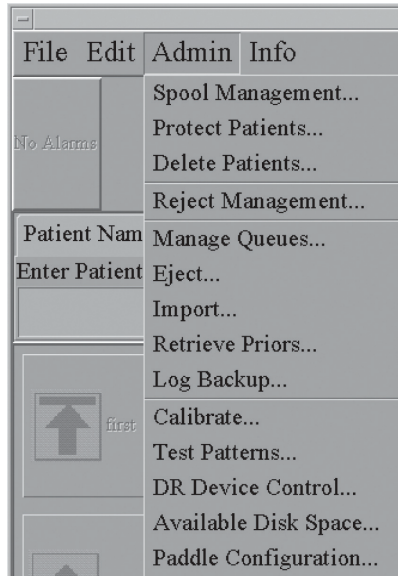

Figure 96: Admin Menu for the Mgr Logon

The Admin Menu items discussed in this section are those only available to the *mgr* login. The table below indicates where each topic on this menu is discussed.

Table 12: The Admin Menu for Mgr Logon

Menu Item	Where discussed
Spool Management	<i>Spool Management</i> on page 122
Protect Patients	<i>Protect Patients</i> on page 96
Delete Patients	<i>Delete Patients</i> on page 129
Reject Management	<i>Reject Management</i> on page 131
Manage Queues	<i>Manage Queues</i> on page 97
Eject	<i>Eject</i> on page 100
Import	<i>Import</i> on page 100
Retrieve Priors	<i>Retrieve Priors</i> on page 102
Log Backup	<i>Log Backup</i> on page 136
Calibrate	QC Manual
Test Patterns	<i>Test Patterns</i> on page 106
Dr. Device Control	Service Use Only
Available Disk Space	Instructions for Use
Paddle Configuration	<i>Paddle Configuration</i> on page 137

4.1 Spool Management

This function changes with the OS logon level. The Spool Management function allows users to manage the image spool space.

- **tech**: resend and repreview images to output devices (labeled "Image Management").
- **mgr**: repreview, resend captured images to output devices, and delete them.

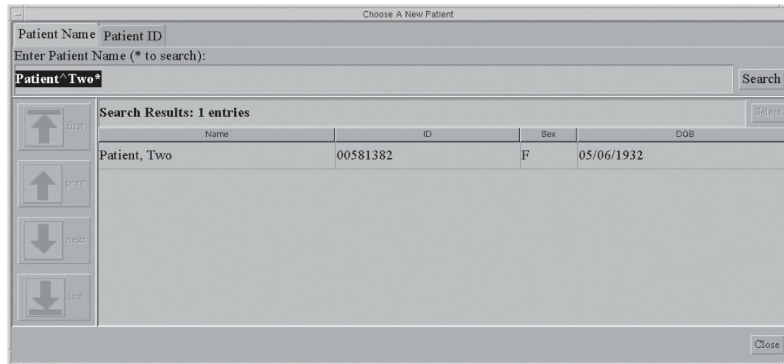

Figure 97: Choose a New Patient Dialog Box

To use Spool Management:

1. Select **Admin>Spool Management**. The **Choose a New Patient** dialog box appears.
2. **Search** for a Patient whose images you want. The query works the same as elsewhere.
3. Select the Patient. The **Spool Management** window appears.



Figure 98: Spool Management Window—One Image Selected

4. Select the image(s) you want to work with. The thumbnails are displayed in the order of acquisition. Use the arrows to scroll if there are more than four views.

If you select a Patient with Rejected Images, you have a thumbnail picture of each of the patient's Rejected Images and demographics. When you click on a thumbnail, information about that view is displayed. See the *figure Spool Management Window—One Image Selected* on page 123.



Note

There is an indication in the upper right pane as to whether or not the archive has committed the View to storage if that function is enabled.

5. Select the tab for the function you want to perform. The details for each function are explained below.
6. Click **Close** to exit Spool Management.

4.1.1 Resend Function

The Resend function allows you to query for Patients whose images are still within the Image Spool and to resend selected images in the spool to Output Destination devices. No Patient or Image object information can be changed from the Resend function. This includes Image or LUT modifications and DICOM information such as Patient Name spelling, ID, Comments, etc. Images are resent to the selected Output exactly as found in the spool.

4.1.2 Printer Contrast and Density

The Print Client in Spool Management applies the Lorad Image Processing algorithm (using the breast density/contrast control parameter) to the Image data as it is sent to the printer.

If a printed film needs to be changed, select Spool Management, and Resend the patient or image. Change the Density and Contrast as necessary for the image. You can resend one or many images, and any changes you make to the Contrast and Density apply to all images you send and only at that time. They are not saved with the images.

4.1.3 What Happens When You Select the Resend Tab

- A list of available outputs becomes active. The default output is the one currently selected in the Patient View Window.
- You can choose to resend all images for the Patient or only selected images.
- Different options are available, depending on the Output(s) selected.
- For example, if you have selected a printer, **Apply PCE** (the Peripheral Contrast Enhancement Function which uses a special algorithm to enhance the appearance of the mammograms) becomes an option.
- A **Resend** button becomes active.

At this point the following functions are also available:

- Query for a New Patient.
- Close Resend without taking any actions.

4.1.4 How to Use the Resend Function

To use the Resend Function:

1. Select a Patient.
2. Click the **Resend** tab.
3. Select the image to Resend or select **Resend All**.
4. Select the **Output**. The Output selected applies only to the Resend function and does not affect Outputs chosen for normal acquisition. Use the **Edit Output** option to add or modify the Outputs.
5. If the selected Output has a printer, the following **Print Image Processing Options** appear. The printing changes are not saved anywhere. Click the option to select or deselect it.
 - Adjust the **Contrast** and **Density** for printing. Change by clicking another number to increase or decrease.
 - **Print True Size** (if available at the printer).
 - **Apply PCE** (the Peripheral Contrast Enhancement Function uses a special algorithm to enhance the appearance of the mammograms).
 - **Omit Patient Name**.
 - **Omit Label options**.

6. Click **Resend**. A dialog box confirms the resend has been performed and the number of images resent. Click **OK**.
7. Click **Close** when you are finished with the **Spool Management** function.

Writing images to a CD takes longer than saving or printing them. For this reason it is usually best to use the Resend option and write them after the procedure is finished. This has the advantage of not slowing down the rest of the procedure while you are waiting for the program to write to the CD during Image Acquisition.

4.1.5 Image Review Function (Also Known as Repreview)

The Image Review function allows you to recall a Patient Image for review and modification. All modifications made during the review are saved with the new image. Additionally, the DICOM tag, Image Type attribute (0008,0008) is set to "DERIVED\SECONDARY." A unique DICOM Image instance UID is created for the image. The image is reclaimed using standard reclaim rules.

You have all the capabilities as in the original Preview (other than reject and accept). The differences from the standard Preview function include:

- The image is not sent to any output devices. If you need to send the image to an output device, use the "resend" function.
- **Save** and **Cancel** buttons are available.

Save creates a new image for the Patient. The original image is not modified in any manner. When you click Save, you save only the changes in markers, orientation and comments. Printer changes are not saved.

Cancel closes the Preview window and displays the Spool Management window.

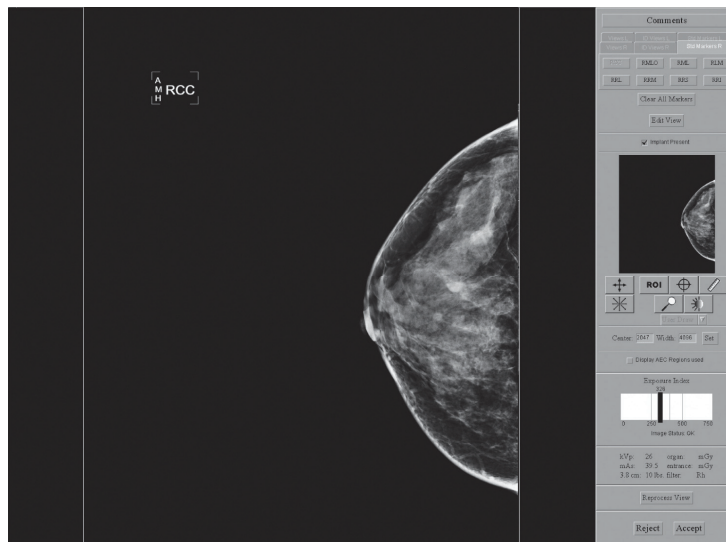

Figure 99: Repreview Window

To use the Repreview Function:

1. Select a Patient from the **Choose A New Patient** list.
2. Select the image to Review.
3. Click the **Repreview** tab.
4. Click **Repreview**. The **Repreview** window appears.
5. Perform the actions and then click either **Save** or **Cancel**.
6. Click **Close** when done with the **Spool Management**.

4.1.6 Archiving Patients with Acquired Images

1. Select **Spool Management** from the Admin Menu.
2. Click **Search** and select the Patient name from the list. The **Review Images** window appears.
3. Click the images you want to resend, or select **Resend all the images**.
4. In the **Setup** window, select any other choices. Select the **Output** for archive.
5. Click **Resend**.
6. Close the **Spool Management** dialog box.

4.1.7 Correcting Incorrect View Selections

The Repreview function is used correct an incorrect view exposure if the error was not corrected before clicking Accept. See *Exposure Taken Using an Incorrect Icon* on page 57.

4.1.8 Delete Image Function

This function allows you to delete all or selected image(s) of a patient from the hard drive. Use this feature to delete incorrect images that are corrected and resent. When you click **Delete**, a dialog box reminds you that the image will be permanently deleted from the Image spool.

To use the **Delete Image** function:

1. Select the image to delete.
2. Select the **Delete** tab.
3. Click **Delete Selected** to choose the Patient Images, or **Delete All for Patient**.

4. Click **Yes** in the **Confirm Operation** dialog box.
5. Click **Close** when done with **Spool Management**.

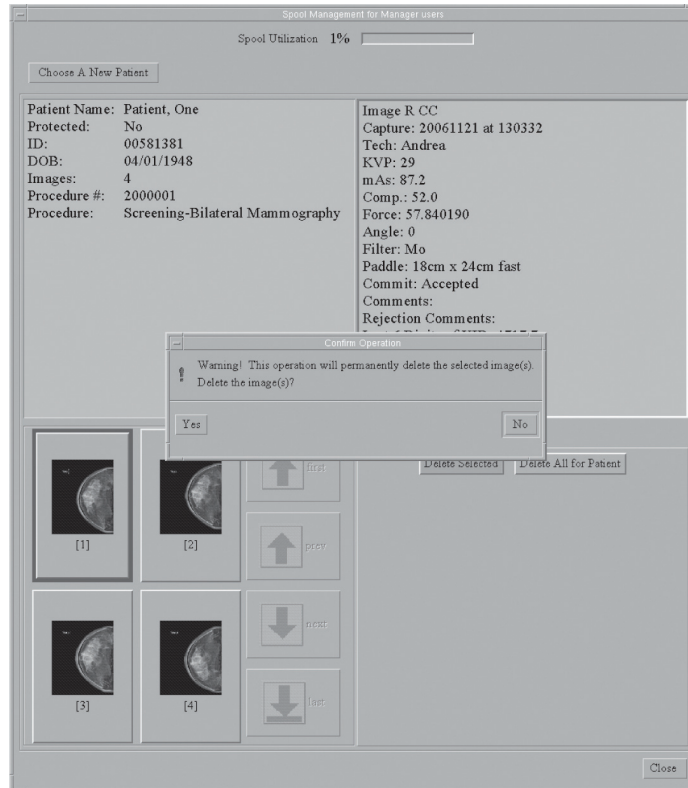

Figure 100: Spool Management-Delete Image Function

4.2 Set Date and Time



Note

The Set Date and Time feature is a manager function.

To set the date and time:

1. Select the Admin tab.
2. Select the Set Date/Time option.

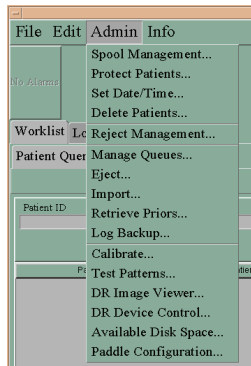

Figure 101: Set Date/Time Option in Admin Menu

3. When the Acquisition Station Date/Time screen displays:
 - Enter the month, day, year in the New Date (MDY) fields.
 - Enter the hour, minutes in the New Time fields.
 - Select AM or PM from the drop-down menu.

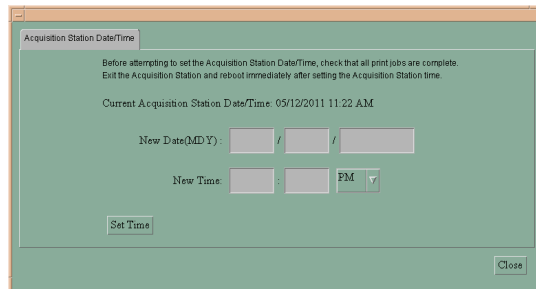

Figure 102: Date/Time Screen

4. Select the **Set Time** button and verify your entries.
5. Select the **Close** button.
6. Restart the system.

4.3 Delete Patients

This option at the *mgr* level allows a manager to delete Patients from the Local Exams and all of the Patients' Images from the Image pool. Successfully exported images and patients are routinely reclaimed, and do not need to be deleted manually.

You can delete a Patient under the following circumstances:

- They have no rejected images in the reject bin.
- All their associated images are successfully exported or deleted from output queues.

To delete a Patient:

1. Select a Patient name from a list, or use the Patient name query to search for the Patient. The **Delete** button activates when a Patient is selected.

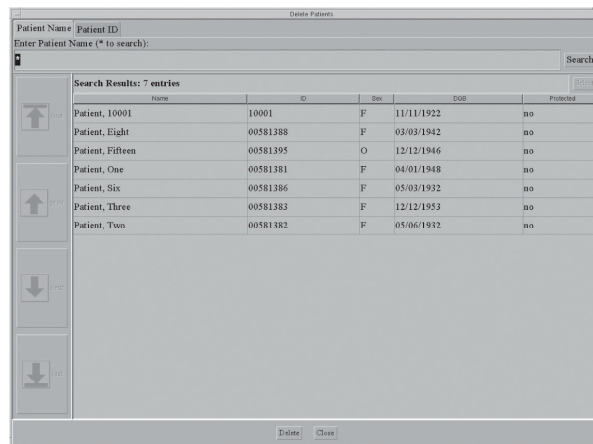

Figure 103: Delete Patient Window

2. Click **Delete**. A dialog box might display reasons why the deletion cannot be performed, or inform you that the patient is protected. If there are protected patients in your selection, a request for confirmation to delete displays. If the message indicates, for example, the Patient has jobs in the reject bin and/or the output queue), the jobs must first be deleted or allowed to pass through the queue. Otherwise, a **Delete Selected Patients and Images** dialog box appears.

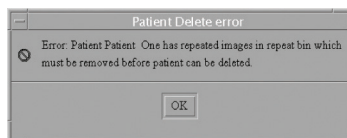

Figure 104: Patient Delete Error Dialog Box

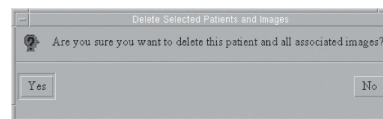

Figure 105: Delete Selected Patients Dialog Box

3. Click **Yes**. The Patient and all related data are deleted.

4.4 Reclaiming



Figure 106: Hard Drive Reclaimed

The Acquisition Workstation computer's hard drive automatically stores the Acquired Images. Information that is successfully sent to other storage is routinely reclaimed from the hard drive in order to make room for new Patient information.

The system automatically reclaims Hard disk storage space for new Procedures using configurable parameters. The image reclaimer deletes images from the system when a number of images (service configurable) have accumulated on the system. Once reclamation of images begins, images continue to be reclaimed until the number of images on the system reaches a lower service configurable number.

The following Reclamation rules use the factory default parameters:

- If there are more than 2000 images on the system, then the 25 oldest images are reclaimed. No Procedure is left with missing images.
- Patients with no images are reclaimed.
- If there are more than 700 Patients, then the 50 Patients (and their images) with the oldest Procedures are reclaimed.

The following is a list of exceptions to these rules:

- No Patients are removed if there are any images queued to an output device.
- No images are deleted for Protected Patients. (Protect a Patient by using the Main Menu function Admin>Protect Patient. Be sure to unprotect them.)
- No images queued up on an output device are reclaimed.
- No images are deleted that have not been successfully printed on film or committed to an archive device, (Archive devices should be set to send commitments).
- Rejected images are not automatically reclaimed. Managers need to periodically remove all Rejected images using **Admin> Reject Management**.



Caution:

If the disk does not have enough available space, the system does not acquire an image. A message displays the capacity of the disk. Delete unneeded images to restore the disk space.



Figure 107: Hard Drive Full Alarm

4.5 Reject Management

This function allows a **mgr** user to manage the Reject Bin. The System Reject Bin provides the following functions:

- Delete Rejected Images
- Display the Reject Bin percentage full
- Select a Patient with Rejected Images and Review the images
- View a report of Rejected Images

A local procedure should be in place for routine examination and removal of Rejected Images, because they are not automatically reclaimed and can fill up the hard drive.



Figure 108: Reject Management Window—(Resend is Shown)

4.5.1 View a Patient's Rejected Images

When you select a Patient with Rejected Images, you have a thumbnail picture of each of the patient's Rejected Images and this information in the upper left pane:

- Patient Name
- If they are protected
- Patient ID
- Patient Birth Date
- Number of images in the Procedure
- Procedure number
- Procedure name

When you click on a thumbnail, information about that view is displayed in the upper right pane:

- Image view
- Date and time of capture
- Tech
- All image and technique information including the paddle used
- If it is Committed
- Comments
- Last six digits of UID

These Tabs allow you to administer the selected patient's images:

- Delete—Delete a selected (or all) image(s) permanently from the Reject Bin.
- Resend—Select an output and re-send a selected image to the output.
- Repreview—View the image

The Rejected Images and the comments are stored in the Reject Bin. DICOM attributes associated with the image and the LUT are held in the Reject Bin in the same manner as Accepted Images.

Proper image evaluation should be performed under the **Repreview** function to ensure effective image evaluation management.

4.5.2 Repreview Rejected Images



Figure 109: Repreview Tab on Reject Management Screen

To repreview rejected images:

1. Select **Admin>Reject Management**
2. Click **Choose a New Patient**.
3. Search for the patient in the **Choose a New Patient** dialog box. The patient's rejected images are displayed in the lower left pane.
4. Click the image you want to review. Image information is in the top of the box.
5. Click the *Repreview* tab, the **Repreview** option button is active. If the **Repreview** button does not display, contact service.
6. Click the **Repreview** button. The Repreview screen appears.
7. Click **Save** or **Cancel** to close the Repreview screen.
8. Click on the **Delete** tab to delete them, or click on the **Resend** tab to resend them to an output and then delete them.
9. Click **Close** to close **Reject Management**.

4.5.3 View Rejected Images Report

There are two different Rejected Images Reports. One on screen where you can see the rejected images, and one in the network browser that presents statistics and can be printed if the computer you are using is connected to a printer. For information on using the printable report, see *Repeat/Reject Reports Options Available from the Browser* on page 138.

When you choose to view the Rejected Images Report, you are able to filter the report to a single technologist, or view all technologists. The report lists the operator name, date, and time for each Rejected Image. Selecting a Rejected Image in the report shows the same information as explained in the previous section, *View a Patient's Rejected Images* on page 132.

To review the rejected images report:

1. Select Admin>Reject Management
2. Click **Rejected Image Report**.
3. Search for a technologist in the **Choose an Operator** dialog box or click **Search** to search for all technologists with rejected images.
4. Select a technologist from the list. The technologist's rejects for the procedure on the date and time listed display on the screen as thumbnails.
5. Click on the **Repreview** Tab to review them. Click on the **Delete** tab to delete them, or click on the **Resend** tab to resend them to an output and then delete them.
6. Click **Close** to close **Reject Management**.

4.5.4 Delete Images from the Reject Bin

Rejected Images should be deleted when they are no longer needed. If this alarm appears on the screen, someone needs to "empty" the Reject Bin.



Figure 110: Reject Spool Full Alarm

To delete images from the Reject Bin in Reject Management by patient:

1. Select a **Patient**, (you can review and resend the image before you delete it).
2. Click the **Delete** Tab.
3. Select the thumbnails of the images to delete and click **Delete Selected**, or click **Delete All for Patient** to delete all of that Patient's images.

To delete them by the technologist who acquired them, use directions in *View Rejected Images Report* on page 134.

4.5.5 Resend Images from the Reject Bin



Figure 111: Reject Management—Resend a Rejected Image

To resend the image before you delete it:

1. Select the **Resend** tab. This window functions the same as those in the regular **Resend Menu**.
2. Click **Resend selected images** or **Resend all images for patient**.
3. Select the **Output**. The Output selected applies only to the Resend function and does not affect Outputs chosen for normal acquisition.
4. If the selected Output has a printer, the **Print Image Processing Options** activate. The printing changes are not saved anywhere.
 - Adjust the **Contrast** and **Density** for printing. Select a different number to make a change.
 - **Print True Size** (if available at the printer).
 - **Apply PCE** (the Peripheral Contrast Enhancement Function uses a special algorithm to enhance the appearance of the mammograms).
 - **Omit Patient Name**.
 - **Omit Label options**.

5. If you are done with the image and are ready to delete it, click **Delete Tab** and select the images to delete if the selection has changed.
6. Click **Delete** or **Delete All for Patient**. This only deletes images in the reject bin.
7. Click **Close** to close **Reject Management**.

4.6 Log Backup

When Service requests, Log Backup saves copies of the system log files to a CD-R.

To back up Log Files:

1. Select **Log Backup** from the **Admin** menu. The Backup dialog box appears.

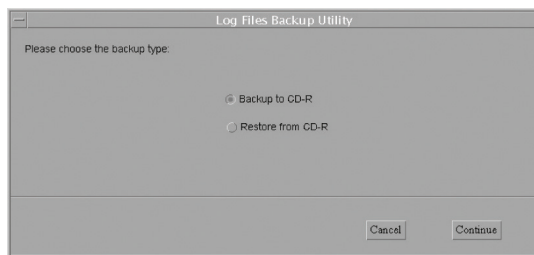

Figure 112: Log Backup—First Dialog Box

2. Select **Backup to CD-R**. Click **Continue**.

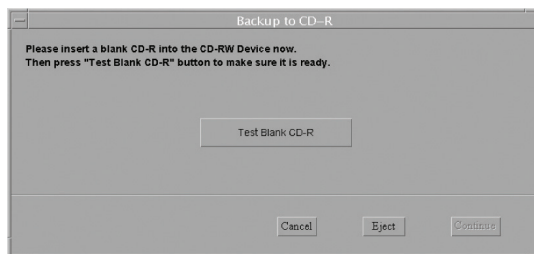

Figure 113: Log Backup—Second Dialog Box

3. Insert a blank CD-R into the CD-RW device.

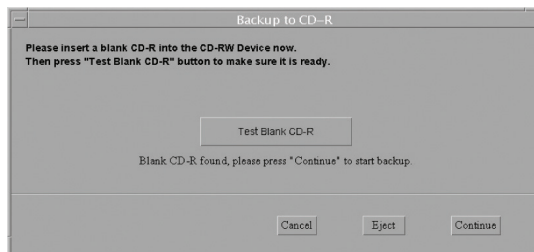

Figure 114: Log Backup—Third Dialog Box

- Click the **Test Blank CD-R** button. The message **Blank CD-R found** appears. Click **Continue**.

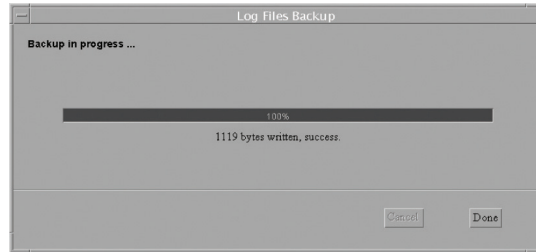

Figure 115: Log Backup—Fourth Dialog Box

- Click **Done** after the files are backed up. The disk auto-ejects.
- Label it per your site procedures and store it safely or send to Hologic if requested.

4.7 Paddle Configuration

This menu option sets up the paddles available to your site. If these options are not set up correctly, an " Incorrect Paddle Position" alarm message appears.

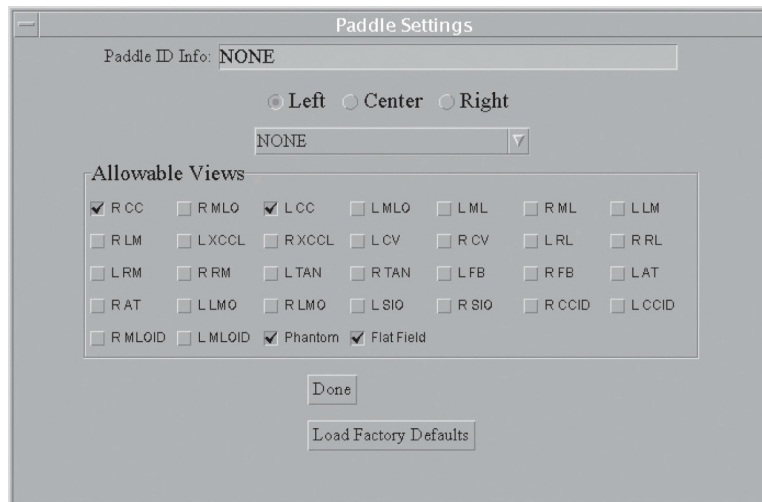

Figure 116: Paddle Configuration Dialog Box

To check a Paddle Configuration or add/change an available View for a paddle:

- Click the arrow for the drop-down list in the center.
- Select the paddle you want to View/Configure. Your selection appears on the **Paddle ID info** line.
- Select **Left, Center, or Right** paddle position for all shifting paddles.
- Check (or clear) the **Allowable Views** for that paddle.
- Repeat steps 1-3 for each paddle you want to configure and for each paddle position.
- Click **Done** when finished.

5.0 Info Main Menu Function

The **Info** function identifies the Acquisition Workstation software versions, the current temperature of the array, and the date, time, and temperature of the last calibration.



Figure 117: Info Screen

6.0 ALARM Function

The Alarm function manages alarms that have occurred due to failed jobs to destination devices. For more information on Alarms, see *Troubleshooting* on page 143.

7.0 Repeat/Reject Reports Options Available from the Browser

7.1 Administrative Reporting

The Reject Analysis Report can be printed for administrative review. It is available from a web browser, not from the Selenia application. Any network connected PC can access them.

7.2 Accessing the Report from Any Computer on the Network

To access these reports:

1. Run the Browser program on your machine.
2. In the Browser Address Bar, type: `http://<the system name you want to access>` or the `<IP Address>:8080` and press Enter. A Password dialog box appears. (The system's IP address is recorded in an Appendix of the Installation Manual.) For additional details, see *Can I Run the Repeat/Reject Analysis from an Office Computer?* on page 18.
3. Exit from the Browser when you are done to maintain security.

7.2.1 Log In Using the Admin Password

Enter Logon Information For This Site

Username	<input type="text" value="admin"/>
Password	<input type="password" value="password"/>

Figure 118: Log on to the Browser

Administration Tools LORAC Selenia

Options

[Change Password](#)
[Reject](#)

Done

Figure 119: Administrative Reporting Options

You can choose to change the browser's password or open Repeat/Reject Analysis.

7.3 Change Password

This changes the browser's password for a Selenia system. Do not change this without system wide agreement.

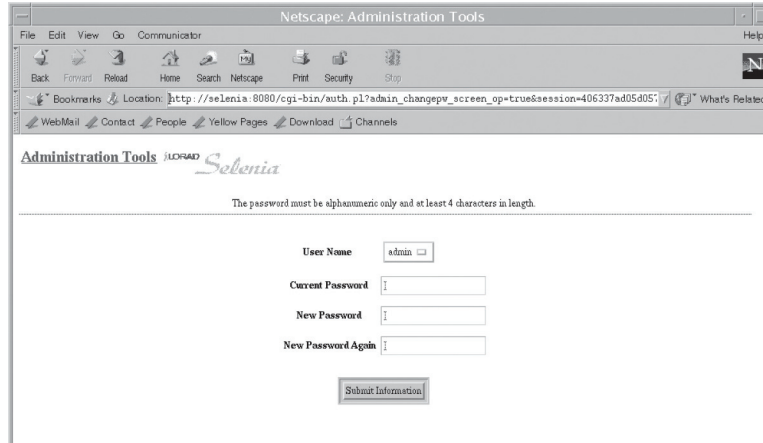

Figure 120: Change Password

7.4 Reject Analysis Report

1. Click the Reject option.
2. Choose the Report Parameters to view.
3. Click Submit. The request is sent to the computer and the information is collected and formatted into a report.
4. Set the page to Landscape, and print the report using the browser's print button.

Administration Tools by LORAD Selenia

Reject

FROM: Day: Month: Year:

TO: Day: Month: Year:

Technologist: Type:

Figure 121: Criteria for Reject Analysis

To Save the Reject Report as a Shortcut on Your Desktop:

1. With the Reject Report Parameters page showing, click **Add to Favorites** in the browser.
2. In the dialog box that appears, type Selenia Reject and the room number if there are multiple units.
3. Click the appropriate button to save the favorite.
4. Once the favorite is saved, click on Favorites.
5. Highlight the link you just saved.
6. Right-click to display a menu of options.
7. Click Send To.
8. Click Desktop (create a shortcut). The shortcut is now on the desktop.

Chapter 6 Troubleshooting

1.0 Alarm Types and System Messages

The goal of an Alarm is to provide feedback about abnormal events associated with either the Image Acquisition on the Acquisition Workstation or the export of Acquired Images to destination devices.

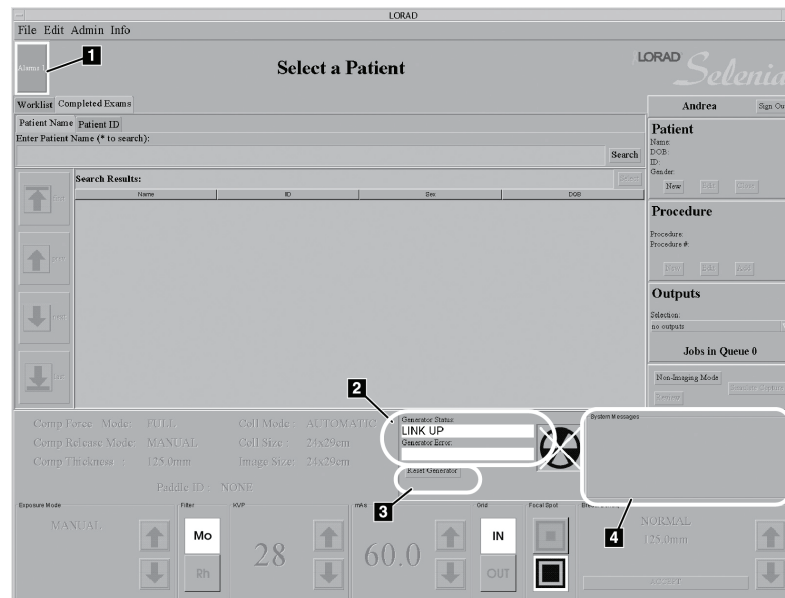

Figure 122: Location of Alarms by Type

Figure Legend

1. Category Two Alarm Icon
2. Category One Alarm Message
3. **Reset Generator** Button
4. System Information and Messages

There are four basic categories of alarms/messages:

- A condition in which the Acquisition Workstation cannot continue (Category One).
- A condition in which the operation of the Acquisition Workstation can continue (Category Two—normally associated with a warning or a failure in an output device).
- A condition in which the image processing has failed, displayed on the Preview screen (Category Three).
- A condition in which the system produces messages explaining why the system is not going into Ready Mode (System Messages).

1.1 Category One Alarm Functions

Category One Alarms appear on the screen in the Alarm Message box. A dialog box appears for Alarms requiring your immediate input. You must close the dialog box before you can acquire an exposure.

For *Category One* alarms, a dialog box appears immediately to indicate a problem that you are required to acknowledge. Depending on the specific condition, a dialog box asks whether to continue or to abort the current action. Some image receptor, generator, and internal alarms are Category One.



Figure 123: Category One Alarm Dialog Box

1.1.1 Sample Category One Alarm Messages

The Operator Message for each alarm contains the alarm number, the associated message as listed below, and the action required (for example, "Press Reset to continue"). If Reset is required, click Reset Generator.



Note

Some conditions, such as Invalid Paddle Position, remain active until the condition is corrected. The Reset command is not required; the Acquisition Workstation message clears automatically once you correct the condition.

Sample Alarm Messages

The table in *Category One Alarms* on page 149 describes Category One Alarm messages.

- "Calculated exposure time exceeds max. Exposure Aborted. Press Reset to Continue."
- "Premature release of x-ray switch. Exposure Aborted. Press Reset to Continue."

1.1.2 AEC Alarm Messages

When the system is unable to use the selected AEC mode to acquire an Image, one of the following messages is displayed.

When you have an Error during exposure:

1. Click **OK** in the dialog box.
2. Click **Reset Generator**.

If the system is unable to use Auto-Filter or Auto-kV, try changing to Auto-Time and selecting a higher, or lower kV as appropriate.



Note

The operator should always be aware of the position of the AEC Sensor when making AEC exposures.

Calculated Exposure Time Less Than Min

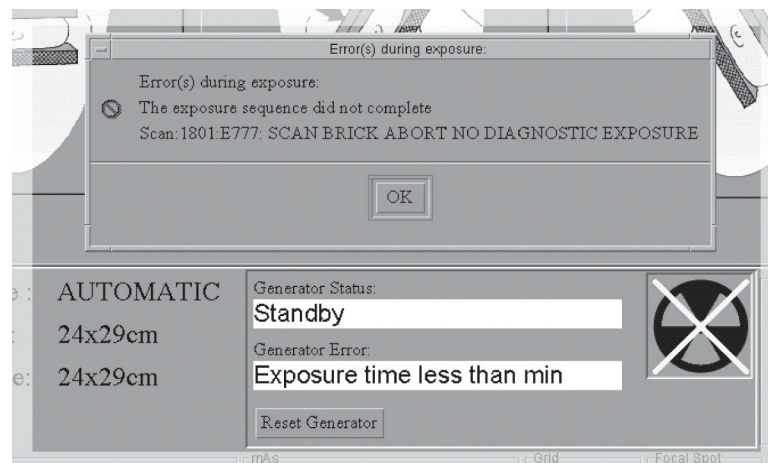

Figure 124: AEC Error Message—Below Minimum

When the AEC Sensor is over an unattenuated or very minimal breast tissue area, the alarm message, "Calculated exposure time less than min," displays in the Generator Status pane. The AEC Sensor should be used in a position under breast tissue. Alternately, use AutoTime and a lower kV.

Calculated Exposure Time Exceeds Max

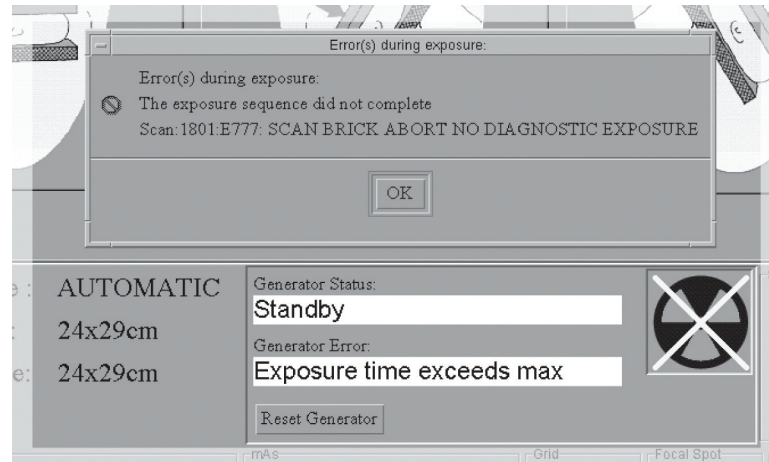

Figure 125: AEC Error Message—Above Maximum

When very dense breast tissue or any object such as an implant, pacemaker, or other anatomy influences the AEC Sensor, the alarm message "Calculated exposure time exceeds max," is displayed in the Generator Status pane. The manual AEC sensor should be used in a position where it is not obstructed. Alternately, use AutoTime and a higher kV.

1.1.3 Generator Related Alarms

If the Gantry generator sends a message classified as an alarm, it displays as a Category One alarm. See the *figure Category One Alarm Dialog Box* on page 144.

1.1.4 Digital Image Receptor Related Alarms

There are four basic classes of alarms associated with the Digital Image Receptor Interface. All four are Category One alarms.

- Start-Up: The array is not responding at start-up.
- Communication: Communications were lost or incorrect mid-operation.
- Image Receptor Error: Error reported from Image Receptor
- Scan ID Error: The Scan ID does not match the one returned from the array.

1.2 Category Two Alarm Functions

Category Two alarms are generally output problems that occur due to jobs that fail at the destination devices. When a new *Category Two* alarm occurs, the Alarm icon indicates that an alarm is present. Viewing the new alarm automatically acknowledges the alarm condition. The Alarm icon highlight remains if alarms are still present. Erase the alarm to clear it.

Output queues handle actual output from the Acquisition Workstation. If a physical device does not accept an exported job, or if it does not complete successfully, it is retried or held as a problem job, depending on the reason for the error. The system performs a service configurable number of retries before it generates an alarm.

Jobs can fail because there is either a problem with a specific part of the job (for example, printing requirements that a printer doesn't support) or because there is a general problem with the physical device (for example, the printer is off-line or not turned on). The system manages queues automatically to prevent problem jobs from clogging the queues. You can view the status of Images that have not left the queue using the Admin>Manage Queues menu function.

An alarm condition is either a warning or a notice. When a message such as a low-film condition is received, an alarm of type "warning" is posted to indicate this. However, this alarm does not get automatically removed when the low-film condition no longer exists; instead, another alarm of type "notice" is posted indicating that the printer status is now normal. The "From" column is not the name of the device posting the alarm, but the name of the spooler to which the alarm was sent.

The *Category Two* Alarm provides the following functions:

- When you click the Alarm icon, the Alarm dialog box becomes active.
- The Alarm dialog box allows you to: view alarms; acknowledge alarms; erase alarms.



Figure 126: Alarm Icon

The Alarm dialog box contains the following:

- Information about the alarm condition:
 - From: Name of the device with the alarm
 - Type: Warning, Notice
 - Subject: Additional system information
 - Time Sent: Time the alarm was posted to the spooler
- An area that displays the message contents.
- A list that shows all of the current alarms sorted in reverse chronological order.
- A **Forward/Backward** button set that allows you to quickly navigate the alarm list.

- An **Erase** and **Erase All** button that allows you to erase the alarm.

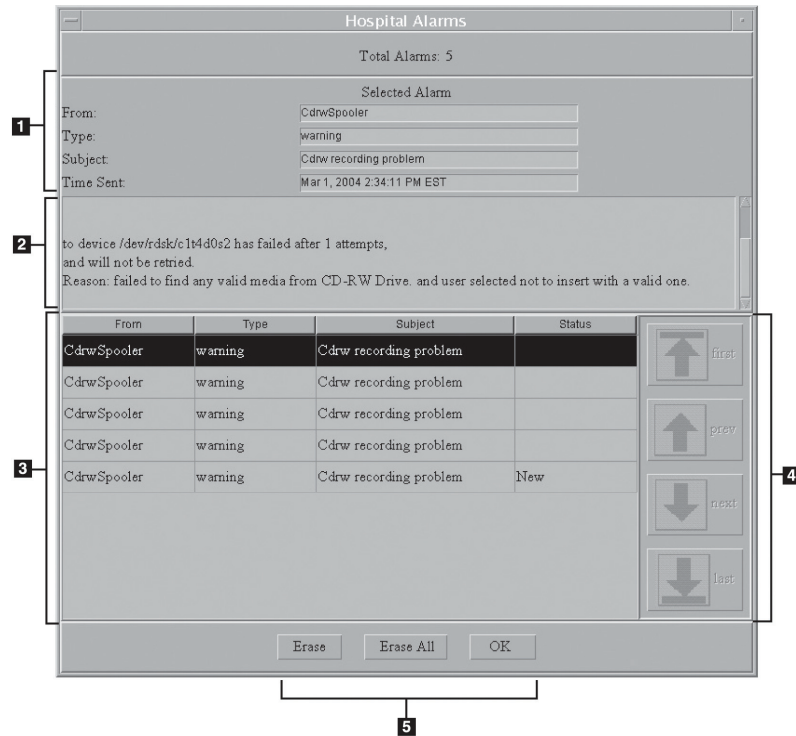

Figure 127: Alarm Dialog Box

Figure Legend

1. Alarm Information
2. Message Display Area
3. Scrolling List of Alarms
4. **List Navigation** Buttons
5. **Erase** and **OK** Buttons

Erase an alarm by selecting the alarm and then clicking **Erase**. Clicking **Erase All** returns the Alarm icon to normal. Erased alarms are completely deleted. Therefore, they may recur, in which case they are treated as new alarms.



Note

If you accidentally click the main screen when an Alarm dialog box appears, re-click the Alarm icon and the dialog box re-appears. If a software problem occurs and a screen stops responding, right-click the top bar of the problem screen and close it.

1.3 Category Four Alarms

System Messages appear in the lower right System Message box. They indicate why the system is not going into the Ready Mode. The table in *System Message Information* on page 161 lists required user responses to these messages. The dashboard panel displays text and changes color (to white) when a system problem occurs. Loss of PXCM to Generator link, receptor power loss, and "Paddle not locked", are examples of messages that appear in the area.

An example of a System Message is:

- "Incorrect Paddle Position."



Figure 128: System Messages

2.0 Tables of Messages and User Actions

2.1 Category One Alarms

Table 13: Alarm Messages

Error #	Cause	Action
2	Calculated exposure time exceeds max	reset / retake in AutoTime mode
3	X-ray switch not released after exposure	reset required
4	Stuck x-ray switch on start-up	reset required
5	Calculated exposure time less than min	reset / retake in AutoTime mode
9	Invalid Cal Data (service call required)	"non-resettable error"
20	Rotor error	reset / re-expose
21	No x-ray switch after start from host	reset / re-expose
22	ARC-kV control error	reset / re-expose
23	TUBE OVERCURRENT	reset / re-expose
24	TUBE OVERVOLTAGE	reset / re-expose
25	INVERTER OVERCURRENT	reset / re-expose
26	X-RAY INTERLOCK FAULT	reset / re-expose
27	FILAMENT OVERCURRENT	reset / re-expose
28	FILAMENT OVERVOLTAGE	reset / re-expose
29	FILAMENT GRID FAULT	reset / re-expose
30	HOST TO GEN. COMM FAULT	reset / re-expose
31	HARDWARE BACKUP TIMER TIMEOUT	reset / re-expose
32	FIRMWARE BACKUP TIMER TIMEOUT	reset / re-expose

Table 13: Alarm Messages

Error #	Cause	Action
33	HV GENERATOR TIMING FAULT	reset / re-expose
34	Spot relay error (unable to switch focal spot)	reset / re-expose
35	Tube Undercurrent Fault	reset / re-expose
51	Bucky error: Bucky not responding	reset / re-expose
52	Brick communication error during exposure (message block 1 request not received)	reset / re-expose
53	No DETECTOR_READY (at start of start exposure, or premature de-activation during x-ray)	reset / re-expose
54	READY signal error (premature de-activation during x-ray)	reset / re-expose
55	Invalid parameter field received in Block 2 or 3 command	reset / re-expose
56	Invalid value field received in Block 2 or 3 command	reset / re-expose
57	Post Exposure Data Error (Selenia did not successfully process post exposure data)	reset / re-expose
58	ERROR signal activation (premature activation during x-ray)	reset / re-expose
59	No mAs received from Brick (New mAs not received during AEC exposure)	reset / re-expose
60	CCW C-ARM Rotation Switch Stuck (stuck switch detected on start-up)	inspect switch
61	CW C-ARM Rotation Switch Stuck (stuck switch detected on start-up)	inspect switch
62	Lamp Switch Stuck (stuck switch detected on start-up)	inspect switch
63	Comp Up Switch stuck (stuck switch detected on start-up)	inspect switch
64	Comp Dn Switch Stuck (stuck switch detected on start-up)	inspect switch
65	Comp Rel Switch Stuck (stuck switch detected on start-up)	inspect switch
66	C-Arm Up Switch Stuck (stuck switch detected on start-up)	inspect switch
67	C-Arm Dn Switch Stuck (stuck switch detected on start-up)	inspect switch
70	No comm from Tubehead	reset
71	filter/mirror error	reset
72	filter error (AF mode)	reset
75	Invalid Paddle Position (Compression Paddle shifted to an "in-between" position.)	*self-correcting

Table 13: Alarm Messages

Error #	Cause	Action
76	Unrecognized Paddle	*self-correcting
79	Compression Device Interference	*self-correcting

*Self correcting errors: Error remains active until the error condition is corrected, and clears once the error condition is corrected—it does not require a "reset." The alarm message on the screen clears once the error clears.

**Undefined error codes: If any error codes not defined above are reported, the alarm message displays "Generator Error#" where # is the error code. Assume that a reset is required.

2.2 Category Three Alarms

Category Three alarms are image processing alarms. An error code in the Exposure Index box on the Preview Screen informs you of problems that have occurred. These alarms appear on the Preview Screen when image processing fails.

Table 14: Image Processing Error Messages

Error #	Message
1000	Image processing is not licensed.
1001	Image is not FOR PROCESSING.
1002	Image orientation flag is missing or not supported.
1003	Paddle ID error.
1004	Internal configuration does not allow for any outputs!
1005	Out of range pixel values.
1006	Calling application did not allocate memory for one or more image outputs.
1007	Invalid data in input image. Data may not be of a mammographic breast image.
1008	Memory allocation error.
1009	Error opening configuration file.
1010	Error opening log data file.
1011	Data bit depth not supported.
1012	Missing required input parameter.
1013	Collimation configuration error.
1014	Laterality error.
2000	Density/contrast input parameters out of range
2001	Pixel manipulation input parameter out of range
2002	Histogram input parameter out of range
2003	Unsharp mask input parameters out of range
2004	PCE input parameters out of range.
2005	P-Value input parameters out of range
2006	Print boundary parameters out of range
2007	Diagnostic density/contrast parameters out of range

Table 14: Image Processing Error Messages

Error #	Message
2008	Implant parameters out of range
2009	Image DC Offset out of range
2010	MCE parameters out of range
2011	Diagnostic logistic parameters out of range
2012	Screening logistic conversion parameters out of range.

2.3 Category Two Alarms

Only the key part of the message is included in this table.

Table 15: Category Two Alarms

Message From	Message	Action Required
Printer or Storage Task	Print request for ID: ..., Name: ... Study: ..., Image: ... to device ... has failed and will be retried. Reason: Failed to communicate with the printer pdev :pdevprint_...; will retry Please contact Hologic service.	Please contact Hologic service.
	Print request for ID: ..., Name: ... Study: ..., Image: ... to device ... has failed after ...attempts, and will not be retried. Reason: Failed to communicate with the printer pdev :pdevprint_...; will retry Please contact Hologic service.	Please contact Hologic service.
	Store request for ID: ..., Name: ... Study: ..., Image: ... to device ... has failed after ...attempts, and will not be retried. Reason: Failed to communicate with the remstore pdev :pdevremstore_...; will retry Please contact Hologic service.	Please contact Hologic service.
	Store request for ID: ..., Name: ... Study: ..., Image: ... to device ... has failed and will be retried. Reason: Failed to communicate with the remstore pdev :pdevremstore_...; will retry	Please contact Hologic service.

Table 15: Category Two Alarms

Message From	Message	Action Required
	Please contact Hologic service.	
	Error happened when trying to initialize CD-RW	Try another CD.
	CD-R space full, and user selected not to replace with a new CD-R	Resend the image later if you want it on a CD.
	CD-R was not recordable, unknown error happened	Try another CD.
Output devices	Messages generated from the outputs or workstation and passed through to the user (for example, printer low on film)	See device documentation for action.
Database Peer Manager	Version mismatch detected: Local (xxx) Remote (yyy)	Call Hologic for service.
	Unable to connect to peer - please consult log file	Call Hologic for service.
MWL Updater	Error updating local worklist	Contact Network Administrator
	MWL updater query received too many results. Not updating local worklist.	Refine query.
	MWL periodic updater timed out querying SCP	Refine query.
	Worklist updater encountered error querying SCP	Contact Network Administrator.
	Worklist updater: Unexpected error encountered.	Call Hologic for service.
DICOM Print alarms	Reading or processing data (image, lut, or marker) failed locally. Please contact Hologic service.	Please contact Hologic service.
	A DICOM dimse error was returned in a response <msg from DCF> Please contact Hologic service.	Please contact Hologic service.
	Cannot open socket to specified host/port, a network error has occurred or received abort from remote system. Please check destination host setup. Please contact your PACS or network administrator.	Please contact your PACS or network administrator.
	The remote device did not accept an association. Please check destination host setup. Please contact your PACS or network administrator.	Please contact your PACS or network administrator.

Table 15: Category Two Alarms

Message From	Message	Action Required
	The remote device is currently unable to accept an association. Please contact your PACS or network administrator.	Please contact your PACS or network administrator.
	Print job was not completed in the allotted time, or time-out waiting for response. Status of print job is unknown. Please contact Hologic service.	Please contact Hologic service.
	Requested DICOM SOP class rejected, or an unspecified error occurred. Please contact Hologic service.	Please contact Hologic service.
	(unknown error) Please contact Hologic service.	Please contact Hologic service.
	<Error or warning message from printer such as a film supply problem, processor problem, or other printer malfunction>	Please contact Hologic service. Also, please consult printer documentation.
	Device address not in form <hostname-or-ipaddr>:<port> Please check destination host setup. Please contact Hologic service.	Please contact Hologic service.
	Unable to ping destination host: <hostname> Please check network connections and destination host. Please contact your PACS or network administrator.	Please contact your PACS or network administrator.
	An unspecified error occurred. Print failed and will not be retried. Please contact Hologic service.	Please contact Hologic service.
	Unexpected CORBA error. Print failed and will not be retried. Please contact Hologic service.	Please contact Hologic service.
	Unexpected local processing error. Print failed and will not be retried. Please contact Hologic service.	Please contact Hologic service.
DICOM Store Commit	Reading or processing image data failed locally. Please contact Hologic service.	Please contact Hologic service.
	A DICOM dimse error was returned in a response. Please contact Hologic service.	Please contact Hologic service.
	Cannot open socket to specified host/port, a network error has occurred or received abort from remote system. Please check destination host setup. Please contact your PACS or network administrator.	Please contact your PACS or network administrator.

Table 15: Category Two Alarms

Message From	Message	Action Required
	The remote device did not accept an association. Please check destination host setup. Please contact your PACS or network administrator.	Please contact your PACS or network administrator.
	The remote device is currently unable to accept an association. Please contact your PACS or network administrator.	Please contact your PACS or network administrator.
	Storage Commit job was not acknowledged in the allotted time. Status of commit job is unknown. Please contact Hologic service.	Please contact Hologic service.
	An unspecified error occurred. Please contact Hologic service.	Please contact Hologic service.
	(unknown error) Please contact Hologic service.	Please contact Hologic service.
	Unable to ping destination host: <hostname> Please check network connections and destination host. Please contact your PACS or network administrator.	Please contact your PACS or network administrator.
	Device address not in form <hostname-or-ipaddr>:<port> Please check destination host setup. Please contact Hologic service.	Please contact Hologic service.
	StorageCommit failed and will not be retried. <error message from database or from DCF> Please contact Hologic service.	Please contact Hologic service.
	StorageCommit failed and will not be retried. Unexpected CORBA error. Please contact Hologic service.	Please contact Hologic service.
	StorageCommit failed and will not be retried. Unexpected local processing error. Please contact Hologic service.	Please contact Hologic service.
DICOM Store Alarms	The remote device is currently unable to accept an association. Please contact your PACS or network administrator.	Please contact your PACS or network administrator.
	The remote device did not accept an association. Please check destination host setup. Please contact your PACS or network administrator.	Please contact your PACS or network administrator.
	A DICOM dimse error was returned in a response: <msg from DCF> Please contact Hologic service.	Please contact Hologic service.

Table 15: Category Two Alarms

Message From	Message	Action Required
	Time-out waiting for response. Please contact your PACS or network administrator.	Please contact your PACS or network administrator.
	Unable to connect to destination host/port. Please check destination host setup and network connections. Please contact your PACS or network administrator.	Please contact your PACS or network administrator.
	A network error has occurred. Please check network connections. Please contact your PACS or network administrator.	Please contact your PACS or network administrator.
	Reading or processing image data (image, lut or marker) failed locally. Please also check local device configuration files. Please contact Hologic service.	Please contact Hologic service.
	Error creating a store job. Please check local device configuration files. Please contact Hologic service.	Please contact Hologic service.
	Unable to ping destination host: <hostname> Please check network connections and destination host. Please contact your PACS or network administrator.	Please contact your PACS or network administrator.
	Device address not in form <hostname-or-ipaddr>:<port> Please check destination host setup. Please contact Hologic service.	Please contact Hologic service.
	An unspecified error occurred. Store failed and will not be retried. Please contact Hologic service.	Please contact Hologic service.
	Unexpected CORBA error. Store failed and will not be retried. Please contact Hologic service.	Please contact Hologic service.
	Unexpected local processing error. Store failed and will not be retried. Please contact Hologic service.	Please contact Hologic service.
	<Error message from DCF> Please contact Hologic service.	Please contact Hologic service.
CD-RW Alarms	Part10Maker:checkDiskCompliant(). CD-RW Drive was busy, will retry later.	No.

Table 15: Category Two Alarms

Message From	Message	Action Required
	Part10Maker:checkDiskCompliant(). Exception caught when trying to check file system ISO 9660 Level 1 conformance with <disk_status.mount_point>.	User has to resend the image at a later time if they want it on a CD.
	Part10Maker:checkDiskCompliant(). Exception caught when trying to guess filename from <disk_status.mount_point>.	Resend the image later if you want it on a CD.
	Part10Maker:checkDiskCompliant(). Error happened when trying to initialize CD-RWSpaceFullDialogObject	Resend the image later if you want it on a CD.
	Part10Maker:checkDiskCompliant(). CD-R does not conform to ISO 9660 level 1 Standard, and user selected not to replace with a new one.	Try another CD-R. Resend the image later if you want it on a CD.
	Part10Maker:checkDiskCompliant(). CD-R does not conform to ISO 9660 level 1 Standard, unknown error happened in CD-RWSpaceFullDialog Object.	Try another CD-R. Resend the image later if you want it on a CD.
	Part10Maker:checkDiskCompliant(). Failed to find any valid media from CD-RW drive. and user selected not to insert with a valid one.	Try another CD-R. Resend the image later if you want it on a CD.
	Part10Maker:checkDiskCompliant(). Failed to find any valid media from CD-RW Drive. unknown error happened in CD-RWSpaceFullDialog Object.	Try another CD-R. Resend the image later if you want it on a CD.
	Part10Maker:doit(). Exception caught while trying to reset the temp dir:<TMPDIR>	Contact Hologic Service.
	Part10Maker:doit(). Exception caught while trying to decrypt image file or convert image to part-10 format.	Resend the image later if you want it on a CD.
	Part10Maker:doit(). A matching image record already exists under that series.	No. The image already exists in the current CD-R.
	Part10Maker:doit(). Exception caught while trying to create DICOMDIR file.	Resend the image later if you want it on a CD.

Table 15: Category Two Alarms

Message From	Message	Action Required
	Part10Maker:doit(). Failed to create temp dicomdir hide file:<dirHideFile>.	Resend the image later if you want it on a CD.
	CD-RWJob_i failed to created CD-RWOutput Object to handle output task. device resource name=<m_description.resource_name>	Resend the image later if you want it on a CD.
	CD-RW Fail: error detecting burning speed. Check CD-RW device path, and make sure the CD is recordable.	Retry. If condition persists with different media, contact Hologic service.
CD-RW Alarms (continued)	CD-RW Fail: error detecting burning speed, CD-RW or CD-R not compatible.	Try another CD-R. Be sure you are using approved CDs.
	CD-RW Fail: error reading CD-RW or CD-R, make sure the CD-R is recordable.	Try another CD-R. Be sure you are using approved CDs.
	CD-RW Fail: error finding session address, make sure the CD-R is recordable.	Try another CD-R. Be sure you are using approved CDs.
	CD-RW Fail: unable to detect the next available recordable address, CD-R probably unrecordable.	Try another CD-R. Be sure you are using approved CDs.
	CD-RW Fail: unable to decide the space needed of the CD-R	Retry. If condition persists with different media, contact Hologic service.
	CD-RW Fail: not enough space on the CD-R. CD-R space full, and user selected not to replace with a new CD-R.	Resend the image later if you want it on a CD.
	CD-RW Fail: not enough space on the CD-R. Error occurred when trying to initialize CD-RWSpaceFullDialogObject.	Try another CD-R. Resend the image later if you want it on a CD.
	CD-RW Fail: error reading CD-RW or CD-R, make sure the CD-R recordable. Error happened when trying to initialize CD-RWSpaceFullDialogObject	Try another CD-R. Be sure you are using approved CDs. Resend the image later if you want it on a CD.

Table 15: Category Two Alarms

Message From	Message	Action Required
	CD-RW Fail: error reading Cd-RW or CD-R, make sure the CD-R recordable. CD-R was not recordable, and user selected not to replace with a recordable CD-R.	Try another CD-R. Be sure you are using approved CDs. Resend the image later if you want it on a CD.
	CD-R Partition being used by other applications (usually means File Manager or terminals are using CD-R). cannot continue, before retry, please exit those applications first.	Exit any other applications and retry.
	CD-RW Drive busy, will retry later.	No
	CD-R Warning: After the record process, CD-R could not be successfully remounted, Please unmount and mount CD-R manually to access the image on CD-R.	Remount CD-R manually.
	CD-RW Fail: error Stopping Volume Management.	Reboot the system. If condition persists, contact Hologic Service.
	CD-RW Fail: error Restarting Volume Management. Please start it manually.	Reboot the system. If condition persists, contact Hologic Service.
Reclamation Alarms	The system is unable to reclaim space for new patient records. Please ensure that there are not an excessive number of protected patients. Call service if problem persists.	Delete unnecessary protected patients.
Repeat Spool Alarms	The repeat bin is full! Please have a manager enter "Repeat Management" through the toolbar ADMIN function to delete repeated images and create more space. Note... The above alarm is for tech logins only.	Delete rejected images in spool.
	The repeat bin is full! Enter "Repeat Management" through the toolbar ADMIN function to delete repeated images and create more space. Note... The above alarm is for all logins but tech logins.	Delete rejected images in spool.

Table 15: Category Two Alarms

Message From	Message	Action Required
	The repeat bin is nearly full! There is only enough space for <space> more repeated image(s). Please have a manager enter "Repeat Management" through the toolbar ADMIN function to delete repeated images and create more space. Note... The above alarm is for tech logins only	Delete rejected images in spool.
	The repeat bin is nearly full! There is only enough space for <space> more repeated image(s). Enter "Repeat Management" through the toolbar ADMIN function to delete repeated images and create more space. Note... The above alarm is for all logins but tech logins.	Delete rejected images in spool.
Sheet Alarms	<print job description>	Review device documentation.
Setup Alarms	Error constructing setup:<setup>	Contact Hologic Service.
DICOM Query/Retrieve	There were error(s) when pulling back the image(s).	Contact Network Administrator.
	(number) image(s) moved successfully. There were error(s) when importing the image(s).	If the message in alarm body doesn't help. Contact Hologic Service.
	Unknown error encountered when pulling back the image(s).	Contact Hologic Service.
	(number) image(s) moved and imported successfully.	No.

2.4 System Message Information

Table 16: System Messages

Message	Meaning	Action
Incorrect paddle position	This indicates that the paddle position is not valid for the selected patient view	Correct the paddle position. The Selenia system only allows the use of certain paddles with specific views. If this message appears, you may need to change the position of the paddle or use a different paddle.
Paddle not locked	This indicates that the paddle is between positions (left, center, right)	Shift the paddle until it clicks into position.
Remove paddle for calibration	This indicates that a paddle is present and a calibration scan is being requested.	Remove the paddle for calibration.
Detector power	The PXXM is reporting that the power to the detector has been removed	Make sure the gantry has power. Examine the emergency stops switches (three) to be sure the switches are off, and the circuit breaker to be sure it is on (up). Reboot the system. If the condition persists, contact Service.
Detector service mode	This indicates that the detector is in service mode.	Reboot the system. If condition persists, contact Service.
Calibration needed	This indicates that a calibration is needed and could be the result of a calibration file that is beyond the calibration life span	Perform a calibration.
Generator problem	The PXXM has lost its link with the generator	Reboot the system. If condition persists, contact Service.
Detector problem	The PXXM has lost its link with the detector	The imaging subsystem has reported that it lost the link with the detector. Reboot the system. If condition persists, contact Service.

Table 16: System Messages

Message	Meaning	Action
Detector hi temp	The PXCM is reporting that the detector hi temperature has been reached and is in danger of being turned off	The detector reached the high temperature. Shut down the system. Contact Service.
Detector not present	This is a reminder that the acquisition workstation was started without a detector present	Not Applicable
Non Acquisition Mode	This is displayed during review and test pattern generation and indicates that the system cannot be used to take patient exposures	Not Applicable
Detector shutdown in (n minutes)	This indicates that the detector is about to be shutdown in n minutes	Click Cancel Shutdown if you are still working. The detector does not shutdown until the backup shutdown time.

3.0 Software Troubleshooting

Table 17: Software Troubleshooting

Symptom	Probable Cause	User Directions
<p>A message appears saying: "The Acquisition Station database is corrupt. The system may have been shutdown incorrectly." It will then give the options of:</p> <ul style="list-style-type: none"> • "Clear database and restart" • "Repair database and restart" • "Exit the application" 	<p>The system detects a database corruption</p>	<p><i>Caution: If you see this message, you should first attempt to repair the database. If after performing this operation, and rebooting, you still receive this message, contact Service.</i></p> <p><i>The "Clear the database and restart" should only be used under direction of a service engineer.</i></p>
<p>White screen with message: program terminated ok</p>	<p>Power problems</p>	<ol style="list-style-type: none"> 1. Turn off the circuit breaker on back of Acquisition Workstation. 2. Wait for UPS to stop beeping (a minimum of 10 minutes). 3. Turn the circuit breaker switch back on. 4. Press the AWS On button. The computer restarts. 5. Log on to the OS.
		
<p>Figure 129: Acquisition Workstation Circuit Breaker</p>		
<p>Forgot user password</p>		<p>Delete user account and re-enter.</p>
<p>Can't make a "tech" into a "manager"</p>	<p>Logged in as tech.</p>	<p>This must be done by a Manager. Delete user account and re-enter it when logged on as a Manager.</p>

Table 17: Software Troubleshooting

Symptom	Probable Cause	User Directions
Panel Power dialog box continues to reappear after using the Emergency Off Switch	System may need to be reset or restarted.	Select the Reset Generator button after selecting OK . If that doesn't work, System may need to be restarted. Shut down the System following the procedure <i>How Do I Turn the System Completely Off?</i> on page 2. After waiting a few minutes, press the power button to restart the system.
No screen function, cursor still moves	Dialog box hidden behind main screen	<p>If you accidentally click the Main screen when an alarm dialog box is displayed, re-click the alarm icon and the dialog box is re-displayed.</p> <ol style="list-style-type: none"> If the main screen appears to be non-functional, click the upper right corner dot of the Main screen bar, and the screen minimizes to an icon that says Lorad. Close any open application dialog boxes (not the little icon boxes on the left). Double Click the icon Application to return it to a full screen. <p>If the Task Launcher screen is accidentally closed, restart the application.</p> <ol style="list-style-type: none"> If a screen does not function—and, there is nothing behind it, after you have minimized the program—click the exit button on the OS task bar at the bottom of the screen. Log out of the session. Click OK on the logout confirmation dialog box. <p>Call field service if these solutions do not work. <i>Do not</i> turn off the Acquisition Workstation circuit breaker with the program running.</p>
Lorad wallpaper appears	Open key pressed.	Press the Open key again or click the application icon on the left and program should reappear.
Incorrect paddle position message doesn't go away	Changed or moved paddle while Preview screen was displayed Paddle not recognized.	<ul style="list-style-type: none"> Restore the previous paddle or position. You may need to also click Reset Generator. Re-seat paddle to confirm good connection. Examine Paddle Configuration table.
Collimation on spot paddles is wrong	Automatic Collimation was turned off in setup	Turn Automatic Collimation back on and leave on.
Error 100	Error transferring preview Image	Restart the system. Be sure to restart the computer every morning.

Table 17: Software Troubleshooting

Symptom	Probable Cause	User Directions
RPC3-Write error	Faulty generator communications, brick, cabling, etc.	Call Service.
Cannot delete patients	Logged in as tech	Log in as Manager.
Image Washed out		Evaluate exposure bar, should be above 250.
CD-RW will not respond		<ul style="list-style-type: none"> • Wait five minutes before trying again. • Look at CDRW spooler in Manage Queues to see if Images are still being transferred. • Wait until Image transfer has finished before retrying. • Try a different media.

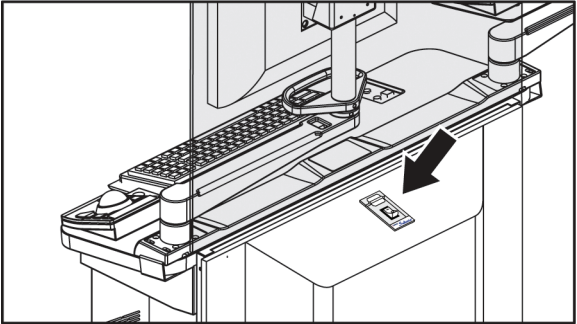
4.0 Worklist Problems

4.1 Unknown RIS Code

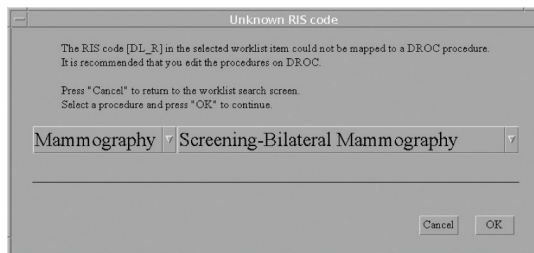

Figure 130: Unknown RIS Code

This dialog box appears if the RIS code returned by the Modality Worklist Provider (Radiology Information System or PACS) does not map to an existing procedure on the Acquisition Workstation. Your options at this point are:

- Click **Cancel** because the previous selection was incorrect.
- Select the correct Procedure from the drop-down list and click **OK**.
- After the Patient is completed, contact your local IS department to ensure the RIS code matches your expectation. Then, if it is still a problem, contact the Selenia help desk for assistance in using the Procedure Editor to add the new RIS code.

4.2 Conflict Between Data in the Modality Worklist and Local Database

When a conflict between the worklist and local database does occur, work with the HIS/RIS administrator to resolve this issue.

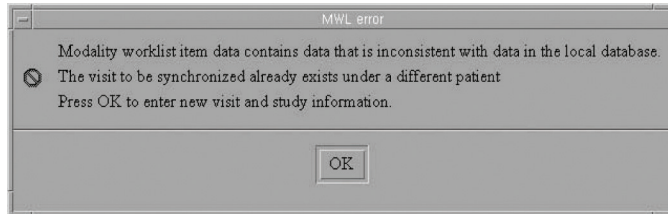

Figure 131: Conflict Between the Worklist and Local Database

This dialog box indicates there is a conflict between the worklist data and an existing Patient in the local database. Verify that you have selected the proper record and that a mistake hasn't been made during scheduling and identifying the patient and procedure.

If you are to assign a new Accession Number, follow this procedure.

1. Click **OK** in the MWL error data box. A New Procedure dialog box appears.

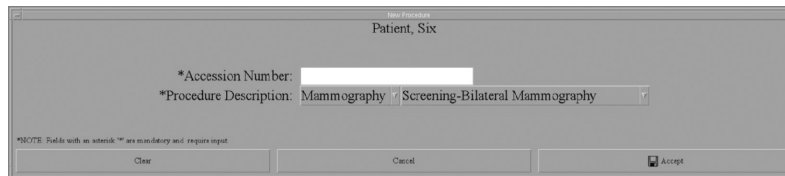

Figure 132: Sample Dialog Box: Add a New Procedure

2. Type a new **Accession number** and select the procedure.
3. Click **Accept**. A new Procedure is added for the Patient.

Another workaround to consider would be to have a manager delete the old record and then reselect the worklist item.

4.3 Resolving Patient Data Conflicts

Depending on which field doesn't match, a dialog box may be displayed allowing you to enter the Local Database information. These changes only apply to the Local Database on the Acquisition Workstation, and do not correct mistakes on the Modality Worklist Server. Inform your HIS/RIS administrator of this issue and work with them to resolve it so that images do not get lost. When you have finished correcting the discrepancies, click OK. The Patient's screen appears.

The screenshot shows a 'Patient Data Conflict Resolution' dialog box titled 'Resolve Patient'. It is divided into two columns: 'Local' and 'Network'. The 'Local' column contains the following fields: *Last Name: Patient, *First Name: One, Middle Name: (empty), *Patient ID: 00581381, *DOB: (MMDDYYYY) 01 / 01 / 1950, *Age of Patient: 054Y, and *Gender: F with a checked checkbox. The 'Network' column contains: Patient, One, (empty), 00581381, DIFF 04 / 01 / 1948, DIFF 055Y, and F. A note at the bottom states: '*NOTE: Fields with an asterisk * are mandatory and require input'. An 'OK' button is located at the bottom center.

Figure 133: Worklist Patient Conflict Dialog Box

Index

A

accept

- image • 52
- rejected image • 15, 53

Accept button • 52

accepted image

- destination devices • 83
- patient view screen thumbnail • 57
- review dialog box thumbnails • 53

access levels • 117

Acquisition Workstation

- local database (Local Exams) • 29

add

- additional procedure • 38, 65
- additional view to procedure • 63
- new procedure
 - to Open Patient • 65
 - with new accession number • 64
- new user • 82
- patient • 34

Admin menu

- mgr • 121
- tech • 92

administrative browser, change password • 139

Administrative Reporting • 138

AEC

- alarm messages • 145
- Auto sensor position • 45
- exposure adjustment settings • 44
- modes • 3, 43, 44
- sensor position settings • 45
- technique defaults • 81
- using • 3, 43

alarms • 143, 147, 151

- Category One • 144, 149
- Category Two
 - alarm icon and dialog box • 147
 - alarm list • 152
 - CDRW alarms • 152
 - DICOM alarms • 152
 - number of alarms • 147
 - Repeat Bin alarms • 152

CD • 91

- functions • 138
- generator • 144
- image receptor • 144, 146
- image spools • 147
- incorrect paddle position • 11, 161
- managing • 138
- output queues • 147
- paddle not locked • 11
- re-display • 147

alarms

- Category Three • 151

allowable views, paddles • 137

AUTO AEC sensor position • 45

B

bar code scanner, use • 30

bar codes • 73

button (software)

- Accept • 52, 64
- Add (Procedure) • 65
- Add View • 10, 63
- Brightness/Contrast (Window/Level) • 52
- button locations on Patient View screen • 39
- Cancel/Clear • 64
- Clean Up • 106
- Close (in Patient box) • 118
- Close Procedure • 39, 62
- Comments • 48
- Edit • 118
- Edit Patient • 39
- Edit Procedure • 39
- Eject • 11
- Exit • 24
- Import Priors • 102
- Measurement • 51
- New Procedure • 64
- New Procedure • 38
- Non-Imaging Mode • 67
- Quick Zoom/Pan • 49
- Reject • 53
- Remove Unexposed Views • 64
- Retrieve and Import • 102
- Review • 69
- ROI (Region of Interest) • 50

- Search • 35, 36
- Set Accepted • 53
- Set Rejected • 55
- Set Technique Defaults • 81
- Simulate Capture • 69
- Window/Level (Brightness/Contrast) • 52

C

- calibration • 23**
- captured images, resending • 122**

C-arm

- alarms • 149
- controls • 74
- movement • 74

CD, CD-RW

- alarms • 91
 - initialization error • 152
 - not recordable • 152
- eject disks • 100
- import images from • 90, 100
- Outputs • 88
- patients on a • 11
- space full alarm • 152
- use • 90, 91

CD-RW drive • 90

- as output • 83
- virtual device name • 90

Center/Width, set • 52**change Patient Information, Accepted Image • 66****change users • 3****Choose a Procedure, Close button • 118****Clean Up button • 106****clinical procedures • 69**

- AEC mode • 72
- manual mode • 70
- TEC mode • 71

Close

- Exam key • 62
- Patient button • 64
- Procedure button • 39
- Procedure button • 62

collimator

- startup defaults • 80

comments

- enter or modify • 48

- required • 53

Communication with the generator is lost • 26**compression**

- release modes • 80

compression force • 80

- startup defaults • 80

contrast for printer, adjust in

- Image Management • 93, 124
- Reject Management • 135
- Resend • 9, 94

cropping, automatic • 52**Crosshairs, use • 77, 78****D****daily restart • 25****data storage (Outputs) • 88****database**

- available • 28
- conflict • 166
- corrupt • 163
- local • 30, 34
 - Local Exams tab • 34
- organization • 28
- synchronization • 30

default view order • 120**defaults**

- exposure modes • 41
- set system • 80, 81

delete

- images • 126
- images from Reject Bin • 132, 134
- job in queue • 99
- output • 87
- patients • 129
- patients • 129

Delete tab • 126

- in Repeat Management • 135

density, adjusting for reprinting in Spool Management, Resend • 124**desktop shortcut, Reject Analysis report • 18****determine job status • 99****dialog box, lost or missing • 147****DICOM storage commitment • 92****digital markers • 48****disk**

eject CD from drive • 91, 100

record images on CD • 90

Dorsal/Ventral hanging • 48

E

Edit menu • 80, 120

Edit Outputs

new groups • 86

tab • 84

Edit Patient button • 118

edit patient data • 64

on an accepted image • 66

with MWL and PACS • 13

Edit Procedure button • 118

location • 39

Edit Users • 82

Edit View • 57

Eject CD • 100

Emergency Off switch • 26

restart system after use • 26

use • 26

error message, Invalid Paddle • 137

error messages see alarms • 149

Exit • 80

exposure

AEC adjustments settings • 44

information pane • 39

status • 47

with incorrect icon and edit view button

corrected after accepted • 57

corrected before accepted • 57

with incorrect icon and no Edit View button

correct after accepted • 58

correct before accepted • 58

exposure modes

AEC • 43

change resets exposure techniques • 41

default • 80

diagram • 41

select • 41

TEC • 42

exposure techniques • 39

default settings • 81

reset to system defaults • 41

select • 41

F

File menu • 24, 80

film label area • 48

flowchart

AEC Modes • 72

Manual Mode • 70

TEC mode • 71

Full Compression Force, Startup defaults • 80

G

Gantry

set up for screening • 74

generator

message pane • 39

problem • 26

related alarms • 146

Reset button • 39

status • 47, 75

H

Hanging options • 48

Hard Drive Full alarm • 130

hard drive, AWS computer • 89

hints

Artifact Evaluation test • 21

Flat Field Calibration test • 20

Phantom View and SNR/CNR tests • 21

I

icons, system ready for exposure • 75

Identify Yourself • 3

Image Management

Repreview • 94

Resend

printing options • 93

Resend • 93

use • 92, 93, 94

Image Pane, film label area • 48

Image Preview screen • 47

Image Repetition Information dialog box • 53

Image Review Function • 125

image spool • 134

Image Status, alarms in queues • 147

images

accept or reject • 52, 78
 acquire • 47, 75
 cropping, automatic • 52
 delete • 126
 from Reject Bin • 134
 rejected • 132
 DICOM attributes • 132
 import • 100
 files from CD • 90, 100
 manage • 92
 outputs see Outputs • 56
 preview • 47, 78
 printing • 124
 problem jobs • 87, 97
 query spool • 92, 123
 recall • 125
 reclaimed • 89
 rejected • 53, 78, 83, 131
 log • 78
 outputs • 46
 repreview • 94
 reprint • 92
 resend • 92, 122, 123, 126
 post procedure • 12
 rejected • 132
 to new output • 56
 retrieve on review workstations • 91
 rules for automatic reclamation • 89
 send accepted to outputs • 83
 store • 78
 technologist initials • 117
 temporary storage • 88
 thumbnails • 57
 view full resolution • 51
 view rejected • 132
 as report • 131
 in Review screen • 78
 work with • 47, 62
Implant exposure techniques • 8
implant present
 button • 49
 correct information
 after accepting • 49
 before accepting • 49
implants

displaced views • 8
 general information • 4
 print images • 9
 procedures • 8

import

image files • 100
 priors in background • 102

incorrect information, places to remove • 66**incorrect view selections**

correcting with an Edit button • 95
 correcting without an Edit button • 58
 how to correct • 57

Info menu • 107, 138**initials, where used • 82****invalid paddle, reconfiguring • 137****J****job status**

determine • 99
 viewing • 87

L**laser printer • 91****Launch, see Wait Time • 23****light field lamp**

use • 74

Local Exams

delete Patients from • 129
 description • 29
 names • 37
 results too long • 36
 search • 35
 sources of data • 29, 30

Local Exams tab • 28**localization**

hints for procedure • 10
 procedures • 76

log backups, mgr function • 136**log in and out of application • 23, 24****Log Out • 25****Log out of the computer • 1****Logout Confirmation dialog box • 1****M****Magnification modes, defaults • 80**

Main menu functions • 79

by user • 118

by user • 118

maintenance, system • 117

Manage Queues • 97, 98, 99

delete (cancel) job status • 99

determine job status • 99

resend stopped job status • 100

Manual exposure mode, technique default options • 81

Markers, digital • 48

Measurement tool • 51

memory, rotation switches • 74

menus

Admin • 92

Edit • 80

File • 80

Info • 107

messages see alarms • 149

Modality Worklist • 28, 33

MPPS, close a procedure • 63

N

network storage • 91

New

Procedure • 64, 65

User • 82

No Outputs warning • 46

Non-Imaging Mode

button • 67

use • 67

O

OS logon level

menu options • 122

output images to CD • 90

outputs • 83, 91

accepted images • 52

add new • 84

alarms for queues • 147

change Resend printer options • 93, 124, 135

change/select destinations button • 63

delete • 83, 87

described • 83

edit • 86

none • 46, 56

on network • 88

pane location • 39

printer • 91

queues • 97

queues • 87

rejected images • 46

remove incorrect information from • 66

retry job options • 97

select • 46

send

accepted rejected images to • 55

images to destination devices • 56

spools • 56

use after procedure closed • 12

use new • 87

Override mode (TEC) • 42

P

paddle alarms • 11

paddle configuration, add or change views • 137

Panel Power dialog box • 26

password

assign • 82

change

for Administrative reports • 139

change • 82

patient

archiving many • 126

correcting wrong information • 13

data conflicts, resolve • 167

data, how to enter • 34

deleting • 129

demographics • 29

edit data • 64

with MWL and PACS • 13

find on a CD • 11

lists • 29

Name tab for local database • 35

pane on Patient View screen • 39

protect from reclamation • 96, 130

query function • 33

search local database • 37

with rejected Images • 131

Patient Close button • 118

Patient Query • 33

- how to enter patient names • 37

Patient View screen • 62

- options chart • 40
- thumbnails • 57

position patient • 74**Power off the computer** • 24**PPS status** • 105

- menu item • 79

Pre-compression force, startup defaults • 80**Preview Image** • 47, 78**Print Image Processing Options** • 93**printer** • 94

- adjust contrast and brightness • 93, 124, 135
- alarms • 147
- change resend options • 93, 124, 135
- configuration • 91
- copies of images • 93
- test patterns • 106

problem jobs

- in output queues • 97
- not reclaimed • 87

procedure

- add another
 - to open patient • 65
 - with new accession number • 64
 - with same accession number • 65
- Add or Edit buttons • 63
- choose • 38
- saving incomplete • 62

program terminated • 163**Progressive Preview** • 48**Protect Patients** • 89, 96**protect Weekly QC** • 17**Q****QC**

- hints • 20, 21
- protect Weekly QC patient • 17

query • 33, 37

- hints for use • 33
- images in spools • 92
- Modality Worklist Provider • 31
- Modality Worklist Provider • 34
- patient tab • 33

- retrieve priors results • 102

queues • 87, 97

- manage • 97, 98
- number of Jobs in Queue • 39
- output • 87

Quick Zoom/Pan • 49**R****radiation icon**

- changes color during x-ray exposure • 75
- system ready indicator • 75

Ready • 47

- status • 75

rebooting the computer • 25**reclaimed, problem jobs not** • 87**reclamation**

- Image spool • 56
- rules for automatic • 89, 130

Region of Interest (ROI), button • 50**reject accepted image** • 55**Reject Analysis**

- Office Computer • 18
- Report • 140
- report criteria • 141
- Shortcut on the Desktop • 18

Reject Bin • 129, 131, 134

- empty • 19
- managing • 131
- see Reject Management • 131

reject image • 52, 53**Reject Management** • 131

- deleting images • 134
- reject bin percentage full • 131
- resending images • 135
- view patient's rejected images • 132
- view rejected images report • 134

Reject Spool Full Alarm • 134**Rejected Images** • 131**removable storage** • 88**Remove Unexposed Views button** • 64**Repreview**

- images • 92
- tab • 125
- use • 94
- window • 125

Reprint image • 124
Reprocess View • 49
Resend • 92, 93, 123, 124
 images • 9, 12, 93, 122
 Images from Reject Bin • 135
 mgr functions • 124
 tech functions • 92
resend stopped job • 100
reset generator • 26, 144
resolve patient data conflicts • 167
restart computer • 25
restart system after Emergency • 26
Retrieve Priors • 102
Review • 69
 use to reject Accepted image • 55
Review dialog box
 use • 53, 55
 view tab • 53
RIS code, unknown • 165
rotation switch memory • 74
Ruler tool see Measurement tool • 51
Rules for automatically deleting images • 130

S

screening procedure • 73
 Mammogram w/Implants • 8
screens
 locked up or missing • 147
 non-functional, but cursor moves • 163
 Patient View • 57, 62
 Preview Image • 47
 Review dialog box • 53
 Select a Patient
 functions available on • 27
 Standard Setup • 80
search • 38
 for Patients • 34
 local database • 34
 Local Exams • 34
 Modality Worklist • 33, 34
 retrieve priors • 102
select
 AEC sensor position • 45
 exposure modes • 41
 exposure techniques • 41
 more than one procedure • 65
 patients in Today's Worklist • 33
 screening options • 73
Select a Patient screen • 27
 chart of options • 27
send
 accepted rejected images to outputs • 55
 images to outputs post procedure • 12, 93
sensor position, AEC • 45
sequence for screening • 73
set Center/Width • 52
set exposure techniques • 41
sign in as a different user • 25
Sign Out • 3
Simulate Capture, button • 69
Sleep mode • 1
SMPTE pattern • 106
software
 version • 107
specimens • 76
spool
 alarms for image status • 147
 deleting images from • 129
 jobs waiting when you exit • 1, 25
Spool Management • 122
 Delete tab • 126
 manage space in image spool • 122
 menu item • 122
 mgr • 122
 Resend • 123
 density, adjusting for reprinting • 124
 using • 122, 124
Standard Setup screens • 80
Start Up and Shut Down reference page • 1
start up, TechMate • 2
Start-up Wait Time • 23
store image on removable media • 88
switch users • 3
switches
 Emergency Off • 26
Synchronization • 30
system
 default setup choices • 80
 message area • 39
 messages • 23

- messages • 149
- messages • 161
- paddle messages • 11
- ready indicator • 75
- start up and turn off • 2

system log files, backing up to CD-R • 136

T

tab, Delete • 126

TEC

- (Tissue Exposure Control), described • 3
- Accept mode • 42
- Exposure mode • 71
- flowchart • 71
- technique default options • 81
- using • 42

tech, access level • 117

TechMate, start up • 2

techniques, exposure • 39

temperature (IR) • 107

test patterns • 106

thumbnails • 53, 57

Today's Worklist tab • 33

U

unreject an image • 15, 53

user interface • 23, 79

User Setup function • 82

users

- access levels • 117
- add, edit and delete • 82, 83
- identification, profiles, rights • 117
- log in different user • 3
- sign in different • 25

V

view

- add • 63
- icon • 57
- image status in output queues • 97, 147
- paddle configuration • 137
- prior images on AWS • 102
- rejected images • 53, 132
- Rejected Images Report • 134
- select • 57

View Order Editor • 81, 120

View Selection, change • 60

W

Wait Time • 23

Weekly Quality Control • 17

- protect • 17

Window/Level • 52

workflow

- clinical procedures • 73
- optional operations • 79

worklist • 33, 167

- local • 30
- Modality • 34
- problems • 165
- resolve patient data conflicts • 167
- tab • 31

write images to CD • 90

X

X-ray

- acquire image • 75
- indicators • 75
- change when in use • 47

Z

Zoom/Pan • 49