

# APEX™ Software

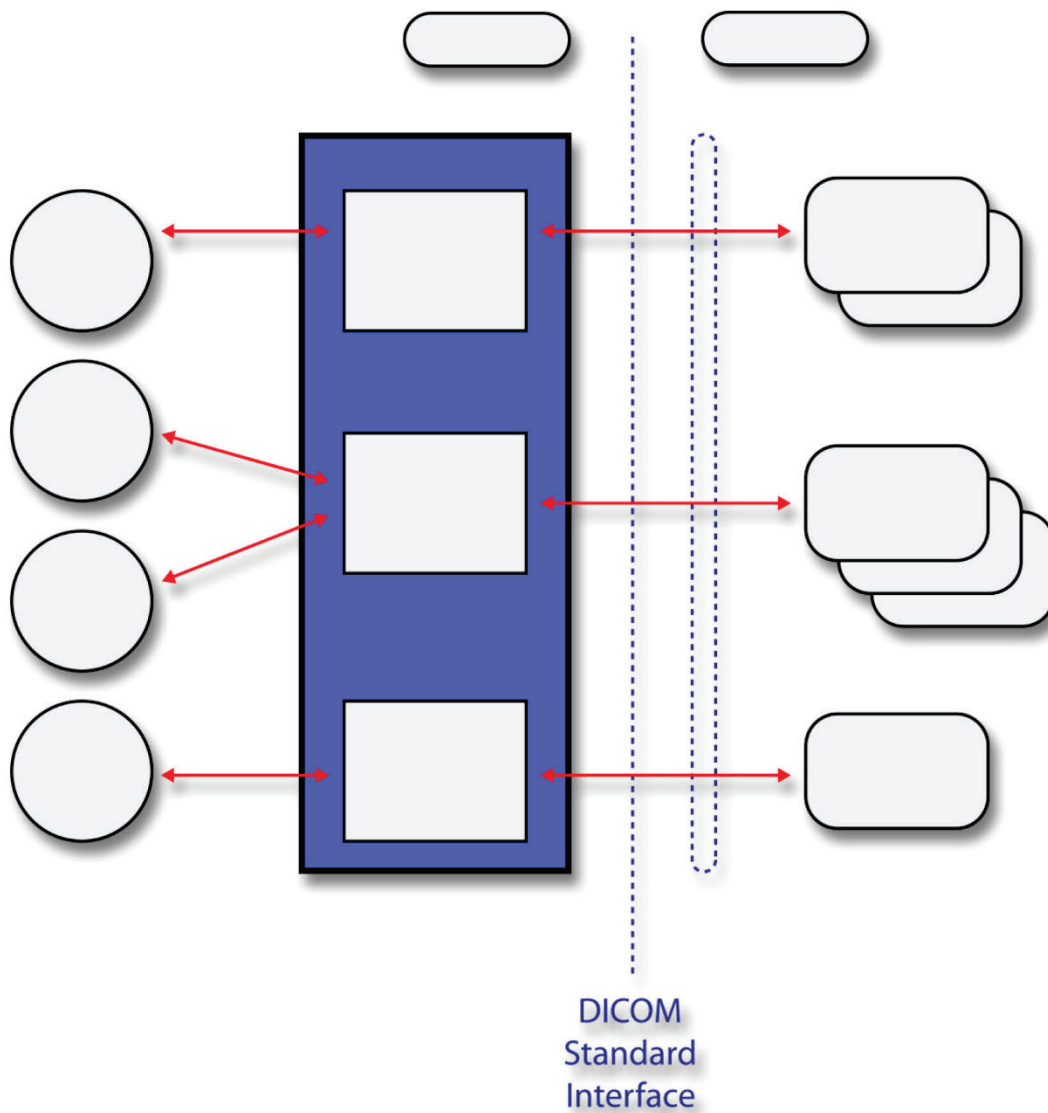

## DICOM Conformance Statement

MAN-07518 Revision 001

# APEX™ Software

Application Software for the Horizon® Series of Densitometers

## DICOM Conformance Statement

For Software Version 5.6.1

Part Number MAN-07518

Revision 001

August 2020

### Product Support

USA: +1.800.321.4659

Email: [SkeletalHealth.Support@hologic.com](mailto:SkeletalHealth.Support@hologic.com)

In Europe, South America, or Asia, contact your local dealer or distributor.

© 2020 Hologic, Inc. Printed in the USA. This manual was originally written in English.

Hologic, APEX, Horizon, QDR, and associated logos are trademarks and/or registered trademarks of Hologic, Inc., and/or its subsidiaries in the United States and/or other countries. All other trademarks, registered trademarks, and product names are the property of their respective owners.

This product may be protected by one or more U.S. or foreign patents as identified at [www.Hologic.com/patent-information](http://www.Hologic.com/patent-information).



Hologic Inc.  
36 Apple Ridge Road  
Danbury, CT 06810 USA  
1.800.447.1856

# 1. Conformance Statement Overview

This document is the DICOM Conformance Statement for APEX 5.6 software for Hologic QDR Bone Densitometers family. It describes DICOM capabilities of the Apex software and how it conforms to the DICOM 3.0 standard.

Table 1.1 provides an overview of the network services supported by APEX.

**Table 1-1.  
NETWORK SERVICES**

SOP Classes	User of Service (SCU)	Provider of Service (SCP)
Transfer		
Secondary Capture Image Storage	Option (see Note 1)	See Note 4
Grayscale Softcopy Presentation State Storage	Option (see Note 1)	No
Workflow Management		
Storage Commitment Push Model	Option (see Note 1)	No
Modality Worklist	Option (see Note 3)	No
Modality Performed Procedure Step	Option (see Note 3)	No
Query/Retrieve		
Study Root Information Model – FIND	Option (see Note 2)	No
Study Root Information Model – MOVE	Option (see Note 2)	No
Notes, Reports, Measurements Transfer		
Enhanced SR Storage	Option (see Note 1)	No
Verification		
Verification	Option (see Note 1)	Option (see Note 1)

Note 1: Secondary Capture Image Storage SCU, Softcopy Grayscale Presentation State Storage, Enhanced SR Storage, and Storage Commitment and Verification services are combined in a separately licensed “DICOM” option.

Note 2: Query/Retrieve service is a separately licensed “Query Retrieve” option.

## **APEX Software DICOM Conformance Statement**

---

Note 3: Modality Worklist and Performed Procedure Step services are combined in a separately licensed “Worklist” option.

Note 4: Apex is capable of receiving DICOM files, but it uses only private data and does not store the files.

## 2. Table of Contents

<b>1. CONFORMANCE STATEMENT OVERVIEW .....</b>	<b>3</b>
<b>2. TABLE OF CONTENTS .....</b>	<b>5</b>
<b>3. INTRODUCTION .....</b>	<b>7</b>
3.1. Revision History .....	7
3.2. Audience.....	7
3.3. Definitions.....	7
3.4. References .....	8
<b>4. NETWORKING .....</b>	<b>9</b>
<b>4.1. Implementation Model .....</b>	<b>9</b>
4.1.1. Application Data Flow .....	9
4.1.2. Functional Definitions of AEs .....	12
4.1.3. Sequencing of Real-World Activities .....	15
<b>4.2. AE Specifications .....</b>	<b>17</b>
4.2.1. Apex Application Entity Specification .....	17
<b>4.3. Network Interfaces.....</b>	<b>58</b>
4.3.1. Supported Communication Stacks.....	58
4.3.2. TCP/IP Stack.....	58
4.3.3. Physical Media Support .....	58
<b>4.4. Configuration .....</b>	<b>59</b>
4.4.1. AE Title / Presentation Address Mapping .....	59
4.4.2. Parameters.....	60
<b>5. MEDIA INTERCHANGE .....</b>	<b>67</b>
<b>5.1. Implementation Model .....</b>	<b>67</b>
5.1.1. Application Data Flow .....	67
5.1.2. Functional Definition of AEs.....	67
5.1.3. Sequencing of Real-World Activities .....	67
5.1.4. File Meta Information .....	67

**5.2. AE Specifications ..... 68**

**6. SUPPORT OF CHARACTER SETS..... 68**

**6.1. Reading Messages ..... 68**

    6.1.1. Single Byte Character Sets without Code Extensions ..... 68

    6.1.2. Multi-Byte Character Sets without Code Extensions ..... 68

    6.1.3. Single Byte Character Sets with Code Extensions ..... 69

    6.1.4. Multi-Byte Character Sets with Code Extensions ..... 69

**6.2. Creating Messages ..... 69**

    6.2.1. Modality Worklist Query ..... 69

**7. SECURITY ..... 72**

**8. ANNEXES ..... 73**

**8.1. IOD Contents..... 73**

    8.1.1. Created SOP Instances ..... 73

    8.1.2. Usage of Attributes from Received IODs ..... 89

    8.1.3. Attribute Mapping..... 89

    8.1.4. Coerced/Modified Fields ..... 91

**8.2. Data Dictionary of Private Attributes..... 91**

**8.3. Coded Terminology and Templates ..... 92**

    8.3.1. Context Groups ..... 92

    8.3.2. Template Specifications..... 105

**8.4. Grayscale Image Consistency ..... 123**

**8.5. Standard Extended / Specialized Private SOP Classes ..... 123**

**8.6. Private Transfer Syntaxes..... 123**

### 3. Introduction

#### 3.1. Revision History

<b>Document Version</b>	<b>Date of Issue</b>	<b>Author</b>	<b>Description</b>
1.0	08/24/2020	Stanley Lee	New document based on MAN-03649, Rev. 003 and added new Structured Report Measures and Regions for unique ROC fields

#### 3.2. Audience

This document is intended for hospital staff, health system integrators, software designers or implementers. It is assumed that the reader has a working understanding of DICOM.

#### 3.3. Definitions

This section provides the definitions of terms, acronyms, and abbreviations that are used throughout the document.

DICOM	Digital Imaging and Communication in Medicine, a standard on image communications in medical applications
HIS	Hospital Information System
RIS	Radiology Information System
AE	Application Entity
SCU	Service Class User
SCP	Service Class Provider
SOP	Service-Object Pair, a definition of an information object (like an image) and a service (like storage) that can be performed for the object
VR	Value Representation, a data encoding method in DICOM
UID	Unique Identifier
DIMSE	DICOM Message Service Element
TCP/IP	Transmission Control Protocol / Internet Protocol, a widely used computer networking protocol
MWL	Modality Worklist
MPPS	Modality Performed Procedure Step
GSPS	Softcopy Grayscale Presentation State
IVA	Instant Vertebral Assessment
SR	Structured Reporting

### 3.4. References

1. American College of Radiology - National Electrical Manufacturers Association (ACR-NEMA) Digital Imaging and Communications in Medicine V3.0-2007.



## **4. Networking**

### 4.1. Implementation Model

#### **4.1.1. Application Data Flow**

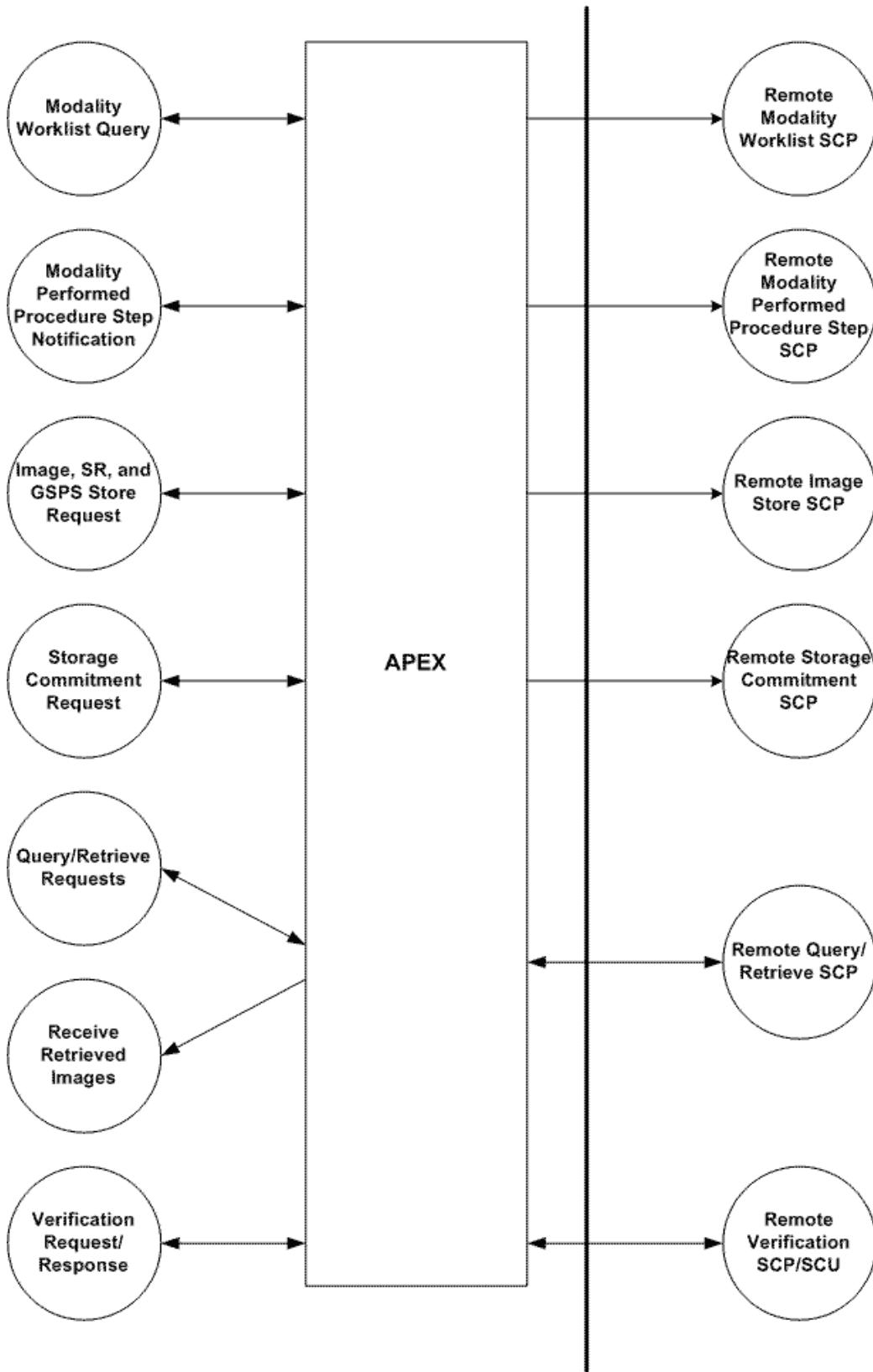

Figure 4.1-1. Application Data Flow Diagram

### 4.1.1.1. Storage

1. Apex AE generates a DICOM file and stores it locally.
2. Apex AE initiates an association with remote Storage SCP.
3. Apex AE pushes the file to the remote Storage SCP using C-STORE command, and then closes the association.

### 4.1.1.2. Storage Commitment

1. Apex AE initiates an association with remote Storage Commitment SCP.
2. Apex AE sends a Storage Commitment request to the remote Storage Commitment SCP using N-ACTION command, and then closes the association.
3. The remote Storage Commitment SCP initiates an association with APEX AE and uses N-EVENT-REPORT command to send a notification about Storage Commitment results, and then closes the association.

### 4.1.1.3. Modality Worklist

1. Apex AE initiates an association with remote Modality Worklist SCP.
2. Apex AE queries the Modality Worklist SCP to obtain Modality Worklist information using C-FIND command, and then closes the association.
3. Apex AE stores obtained Modality Worklist information in the local database.

### 4.1.1.4. Modality Performed Procedure Step

1. Apex AE initiates an association with remote Modality Performed Procedure Step SCP.
2. Apex AE notifies the MPPS SCP about started procedure using N-CREATE command, and then closes the association.
3. Apex AE initiates an association with remote MPPS SCP.
4. Apex AE notifies the MPPS SCP about completed or canceled procedure using N-SET command, and then closes the association.

### 4.1.1.5. Query/Retrieve

1. Apex AE initiates an association with remote Query/Retrieve SCP.
2. Apex AE queries the Query/Retrieve SCP to obtain the information about studies using C-FIND command, and then closes the association.
3. Apex AE initiates an association with remote Query/Retrieve SCP.
4. Apex AE sends a retrieve request using C-MOVE command.
5. Apex AE receives incoming C-STORE requests, extracts Apex scan data contained in a private group, and discards the rest of the DICOM message.
6. Apex AE closes the association.

## 4.1.1.6. Verification SCU

1. Apex AE initiates an association with remote Verification SCP.
2. Apex AE verifies the DICOM connectivity using C-ECHO command.
3. Apex AE closes the association.

## 4.1.1.7. Verification SCP

1. Remote Verification SCU initiates an association with APEX AE.
2. Remote Verification SCU verifies the DICOM connectivity using C-ECHO command.
3. Remote Verification SCU closes the association.

## 4.1.2. Functional Definitions of AEs

### 4.1.2.1. Functional Definition of Apex Application Entity

#### 4.1.2.1.1. Storage SCU

The user initiates sending DICOM files via the user interface. In addition to the image files, Apex AE may automatically generate GSPS files and IVA Results files for IVA scans, based on the configuration settings. SR files may be generated along with corresponding image files, or separately. Apex AE generates DICOM files, stores them locally, and puts corresponding entries in the queue. Immediately after this, it tries to send the files to specified Storage SCPs. In case of failure, it will retry sending files according to the configured queue settings. The user can monitor status of each queue entry, delete entries from the queue, and access the history via the user interface.

Storage SCPs may also be selected as Apex scan archive locations. In this case DICOM files will also include private Apex scan data, for subsequent restoring using the Query/Retrieve service. The SCP network parameters and study DICOM information associated with an Apex scan will be saved in the local database, to be able to locate a scan and perform Retrieve without preceding Query.

#### 4.1.2.1.2. Storage Commitment

If given DICOM Storage destination is configured in Apex to use Storage Commitment, then upon successful completion of Storage request, Apex AE writes a queue entry for the sent DICOM file. Upon next iteration of the queue execution, Apex AE issues Storage Commitment request. In case of failure, it will retry according to the configured queue settings. The user can monitor status of each queue entry and access the history via the user interface.

### 4.1.2.1.3. Modality Worklist

Worklist query may start automatically according to the configured schedule, or may be initiated by the user. Upon successful query, received results are stored in the local database and are accessible by the user via the user interface.

During receiving the worklist response items are counted and the query processing is stopped if the configurable limit of items is reached. The Worklist results older than configured number of days will be cleared with the next Worklist update.

In case of failure of scheduled automatic query, the Apex AE will retry it according to configured settings. In case of failure of user-initiated query, no retry attempts will be made.

### 4.1.2.1.4. Modality Performed Procedure Step

The Apex AE performs the creation of a MPPS Instances automatically whenever images are acquired, if all of the following conditions are met:

- MPPS is enabled
- Images are acquired for a study selected from Worklist

After all images for a study are acquired, or the acquisition is aborted, the Apex AE automatically issues corresponding “Complete” or “Discontinued” update.

In case of failure, the Apex AE will retry the entire flow according to the configuration settings.

### 4.1.2.1.5. Query/Retrieve

#### 4.1.2.1.5.1. Query

The user can initiate the query. Query is performed on Study level. Upon receipt of a successful response from the SCP, the Apex AE displays the received results.

#### 4.1.2.1.5.2. Retrieve

The user initiates the retrieve operation. For retrieve parameters, the Apex application may either use the study information obtained from the query, or use the information previously saved in the local database at the time when images were sent to a remote SCP. In first case, the Retrieve operation is performed on Study level, and in second case on Series level. The Apex AE Title is specified as Move Destination.

#### 4.1.2.1.5.3. Receive Data

Upon startup, Apex application listens for incoming association requests. Upon receiving and accepting a C-STORE request, the application parses received DICOM message. If the message contains private Apex scan data, the application extracts it and restores Apex scan into the system. The rest of the DICOM message content is discarded.

**4.1.2.1.6. Verification SCU**

The user may send a verification request to any SCP the Apex AE is configured to use.

**4.1.2.1.7. Verification SCP**

The Apex application listens for incoming verification requests. Upon receiving a request, it sends back a response.

### 4.1.3. Sequencing of Real-World Activities

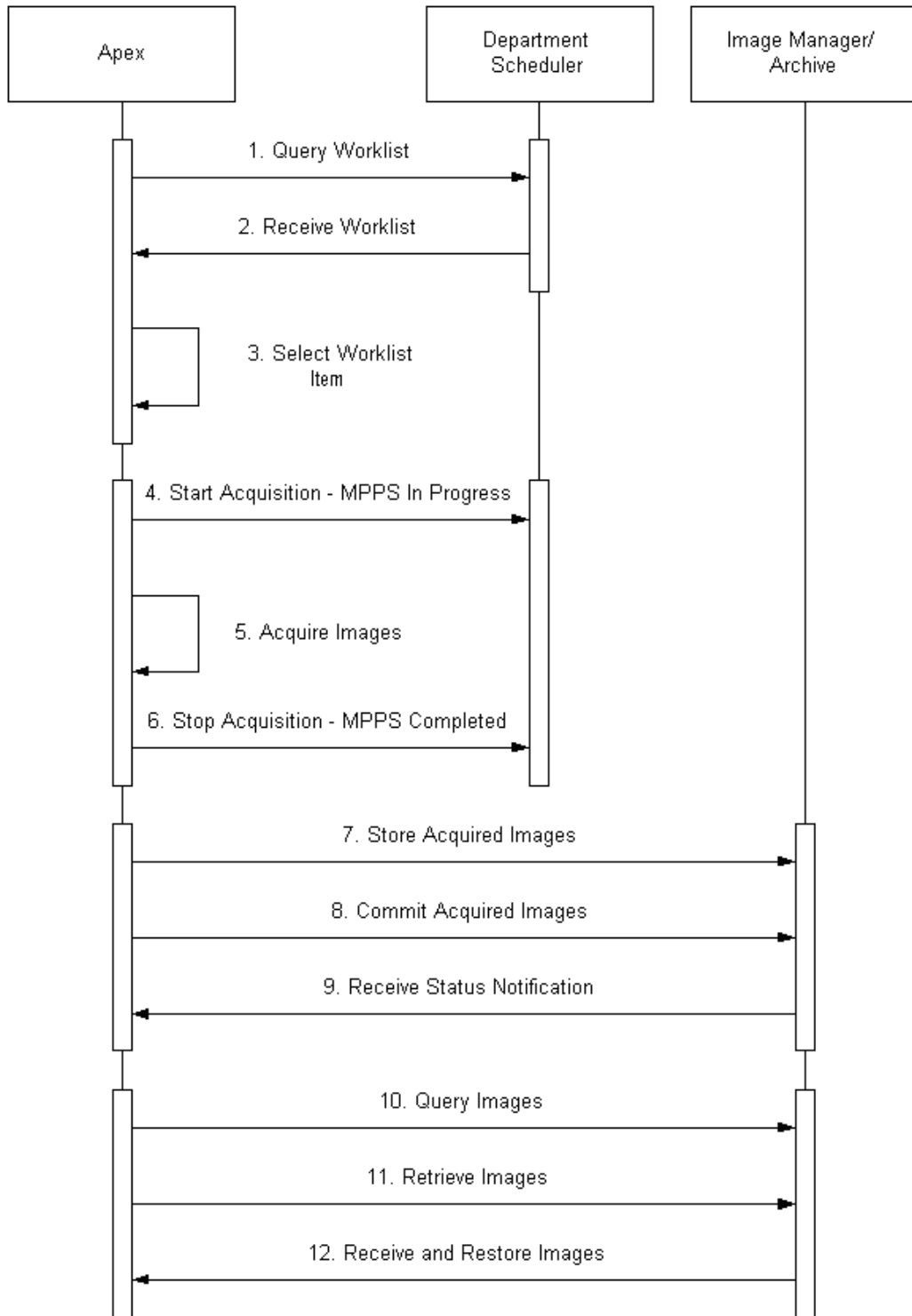

Figure 4.1-2. Sequencing of real-world activities

Following steps may be performed under normal scheduled workflow conditions:

1. Query Modality Worklist
2. Receive Modality Worklist
3. Select a procedure from Worklist
4. Start image acquisition. Send MPPS In Progress – only if:
  - a. Procedure is obtained from Worklist, and not entered manually
  - b. Apex field “Study name” (mapped to a certain Worklist attribute) contains study name that is also configured as one of the available exam types in Apex.
5. Acquire images
6. Stop image acquisition. If MPPS In Progress was sent, then send MPPS Completed or Discontinued:
  - a. Send MPPS Completed if all scans configured for that Apex exam type are performed
  - b. Send MPPS Discontinued if not all scans configured for that Apex exam type are performed
7. Store acquired images
8. Commit acquired images, if configured so
9. Receive notification report about commitment status
10. Query images
11. Retrieve images
12. Receive images. Restore images if they contain Apex scan data.



## 4.2. AE Specifications

### 4.2.1. Apex Application Entity Specification

#### 4.2.1.1. SOP Classes

Apex application provides Standard Conformance to the following DICOM V3.0 SOP Classes:

**Table 4.2-1.  
SOP Classes**

SOP Class Name	SOP Class UID	SC U	SC P
Modality Worklist Information Model - FIND	1.2.840.10008.5.1.4.31	Yes	No
Modality Performed Procedure Step	1.2.840.10008.3.1.2.3.3	Yes	No
Secondary Capture Image Storage	1.2.840.10008.5.1.4.1.1.7	Yes	No
Grayscale Softcopy Presentation State Storage	1.2.840.10008.5.1.4.1.1.11.1	Yes	No
Storage Commitment Push Model	1.2.840.10008.1.20.1	Yes	No
Study Root Query/Retrieve Model – FIND	1.2.840.10008.5.1.4.1.2.2.1	Yes	No
Study Root Query/Retrieve Model - MOVE	1.2.840.10008.5.1.4.1.2.2.2	Yes	No
Enhanced SR Storage	1.2.840.10008.5.1.4.1.1.88.22	Yes	No
Verification	1.2.840.10008.1.1	Yes	Yes

#### 4.2.1.2. Association Policies

##### 4.2.1.2.1. General

The DICOM standard application context name for DICOM 3.0 is always proposed:

**Table 4.2-2.  
DICOM Application Context**

Application Context Name	1.2.840.10008.3.1.1.1
--------------------------	-----------------------

**4.2.1.2.2. Number Of Associations**

Maximum number of simultaneous associations initiated for each activity:

**Table 4.2-3.  
Number of Initiated Associations**

Storage SCU	1
Storage Commitment SCU	1
Query Retrieve SCU	1
Worklist SCU	1
MPPS SCU	1
Verification SCU	1

Maximum number of accepted simultaneous associations:

**Table 4.2-3.  
Number of Accepted Associations**

Number of associations	20 (configurable)
------------------------	-------------------

**4.2.1.2.3. Asynchronous Nature**

The Apex AE does not support asynchronous communications.

**Table 4.2-4.  
Asynchronous Nature**

Maximum number of outstanding asynchronous transactions	1
---	---

**4.2.1.2.4. Implementation Identifying Information**

The Implementation Identifying Information for the Apex AE is:

**Table 4.2-5.  
Implementation Identifying Information**

Implementation Class UID	1.2.840.113850
Implementation Version Name	Apex3.4

## 4.2.1.3. Association Initiation Policy

### 4.2.1.3.1. Activity – Send Images

#### 4.2.1.3.1.1. Description and Sequencing of Activities

A user can select scans and request them to be sent to multiple destinations (images and/or SRs). Based on the configuration settings, additional IVA Results file and GSPS file may be automatically generated for IVA scans. Each request is forwarded to the send queue and processed individually. If GSPS file is generated along with image file, both files are treated as one queue entry. If IVA Results file is generated, it is treated as a separate queue entry. If the same scan is requested to be sent to multiple destinations, there is a separate queue entry for each destination. Each request is processed immediately after forwarding to the send queue. Requests are processed in the same order as they were initially entered. For image/GSPS files pair, a GSPS file is attempted to be sent only after the image file was successfully sent.

The Apex AE initiates an association with Storage SCP AE specified in the first queue entry, and sends files using C-STORE Request. For the subsequent queue entries, the Apex AE issues C-STORE Requests over the same association as long as each following queue entry specifies the same Storage SCP AE. If an entry specifies a different AE, Apex closes the current association and opens a new one with specified new Storage SCP.

If an association cannot be established with the Storage SCP, or if the C-STORE Response from the Storage SCP contains a status other than Success or Warning, the related send queue entry is marked as pending. The Apex AE will retry sending files for pending queue entries according to the configured settings. For image/GSPS file pair, if an image file was successfully sent, and sending the GSPS file failed, the Apex AE will retry to send only the GSPS file.

After exercising maximum number of attempts to send files for a queue entry, the entry is marked as failed, and no further attempts will be performed.

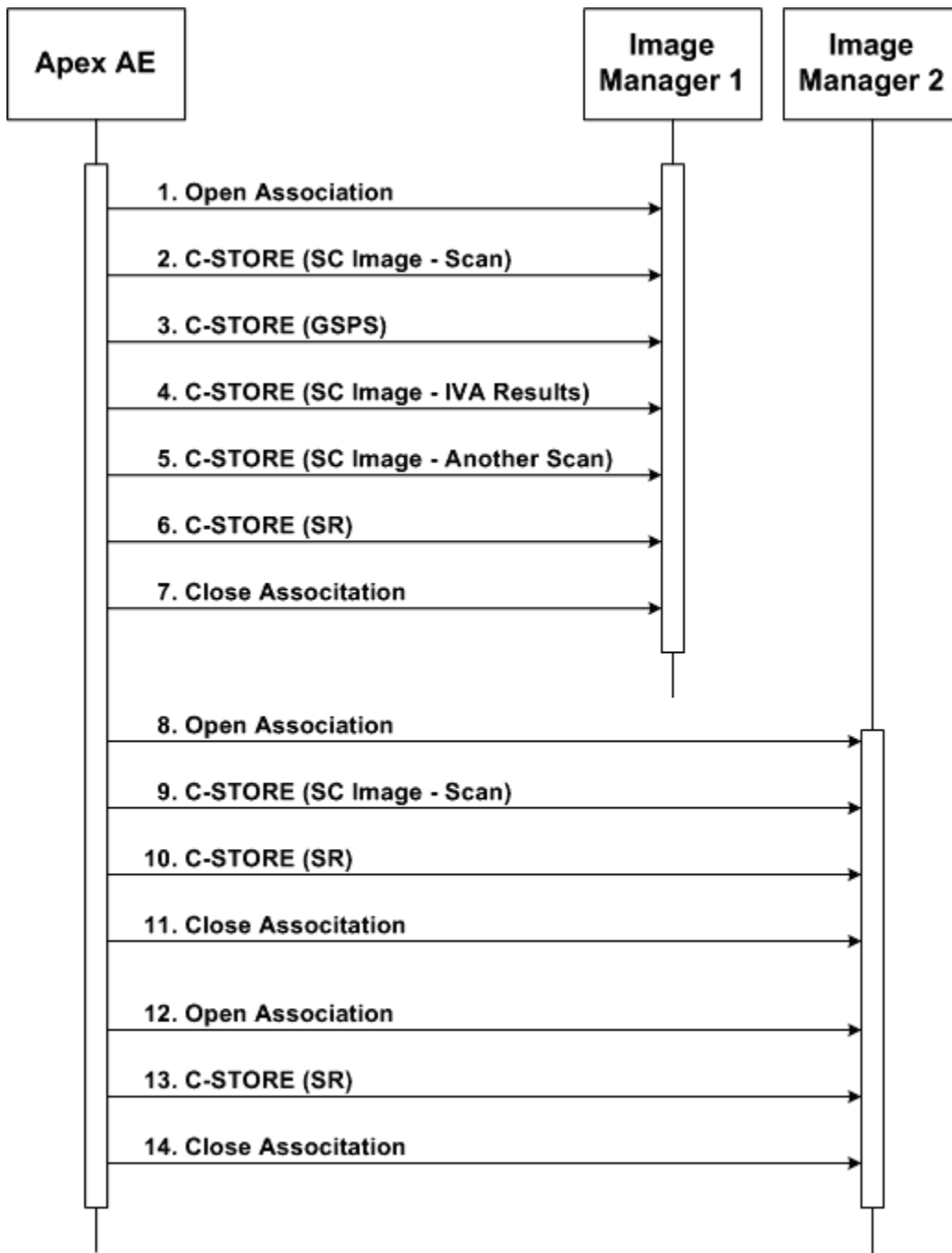

Figure 4.2-1. Sequencing of Activity – Send Images

A possible sequence of interactions between the Apex AE and an Image Manager (e.g. a storage or archive device supporting the Storage SOP Classes as an SCP) is illustrated in Figure 4.2-1:

1. The Apex AE opens an association with the Image Manager.
2. An SC image for acquired scan is transmitted to the Image Manager using a C-STORE request and the Image Manager replies with a C-STORE response (status success).
3. A GSPS instance is transmitted to the Image Manager using a C-STORE request and the Image Manager replies with a C-STORE response (status success).
4. An SC image for IVA Results is transmitted to the Image Manager using a C-STORE request and the Image Manager replies with a C-STORE response (status success).
5. An SC image for another acquired scan is transmitted to the Image Manager using a C-STORE request and the Image Manager replies with a C-STORE response (status success).
6. A matching SR instance is transmitted to the Image Manager using a C-STORE request and the Image Manager replies with a C-STORE response (status success).
7. The Apex AE closes the association with the Image Manager.
8. The Apex AE opens an association with another Image Manager.
9. An SC image for acquired scan is transmitted to the Image Manager using a C-STORE request and the Image Manager replies with a C-STORE response (status success).
10. A matching SR instance is transmitted to the Image Manager using a C-STORE request and the Image Manager replies with a C-STORE response (status success).
11. The Apex AE closes the association with the Image Manager.
12. The Apex AE opens an association with Image Manager.
13. An SR instance (without a matching SC image) is transmitted to the Image Manager using a C-STORE request and the Image Manager replies with a C-STORE response (status success).
14. The Apex AE closes the association with the Image Manager.

NOTE: Many other message sequences are possible depending on the number of scans to be stored, scan types, number of destinations, and configuration settings.

**4.2.1.3.1.2. Proposed Presentation Contexts**

**Table 4.2-6.**

**Proposed Presentation Contexts for Activity – Send Images**

Abstract Syntax		Transfer Syntax		Role	Extended Negotiation
Name	UID	Name List	UID List		
Secondary Capture Image Storage	1.2.840.10008.5.1.4.1.1.7	Implicit VR Little Endian	1.2.840.10008.1.2	SCU	None
		Explicit VR Little Endian	1.2.840.10008.1.2.1		
		Explicit VR Big Endian	1.2.840.10008.1.2.2		
Grayscale Softcopy Presentation State Storage	1.2.840.10008.5.1.4.1.1.11.1	Implicit VR Little Endian	1.2.840.10008.1.2	SCU	None
		Explicit VR Little Endian	1.2.840.10008.1.2.1		
		Explicit VR Big Endian	1.2.840.10008.1.2.2		
Enhanced SR Storage	1.2.840.10008.5.1.4.1.1.88.22	Implicit VR Little Endian	1.2.840.10008.1.2	SCU	None
		Explicit VR Little Endian	1.2.840.10008.1.2.1		
		Explicit VR Big Endian	1.2.840.10008.1.2.2		

**4.2.1.3.1.3. SOP Specific Conformance**

The behavior of Apex AE when encountering status codes in a C-STORE response is summarized in the table below:

**Table 4.2-7.**

**C-STORE Response Status Handling Behavior**

<b>Service Status</b>	<b>Further Meaning</b>	<b>Error Code</b>	<b>Behavior</b>
Success	Success	0000	Job is marked as successful
Warning	Coercion of data elements	B000	Job is marked as successful
Warning	Data set does not match SOP class	B007	Job is marked as successful
Warning	Elements discarded	B006	Job is marked as successful
Any other status codes			Job is marked as pending. Status code and contents of the Error Comment attribute (0000,0902) (if present) is logged and accessible via the UI. Further retry attempts will be made until maximum retry number is reached, after which the job is marked as failed.

The behavior of Apex AE during communication failure is summarized in the table below:

**Table 4.2-8.**

**Communication Failure Behavior**

<b>Exception</b>	<b>Behavior</b>
Association cannot be established	Job is marked as pending. Failure reason is logged. Further retry attempts will be made until maximum retry number is reached, after which the job is marked as failed.
Timeout	
Association aborted by the SCP or network layers	

### 4.2.1.3.2. Activity – Send Storage Commitment Request

#### 4.2.1.3.2.1. Description and Sequencing of Activities

After a scan image and/or SR (and a GSPS instance and an IVA Results image for IVA scans - if configured) are successfully sent to a destination, and the Apex AE is configured to treat this destination as Storage Commitment SCP, the Apex AE creates corresponding entries in the Storage Commitment queue. A separate queue entry is created for each sent DICOM file. (I.e. if files sent for a scan are image, GSPS, and IVA Results, then 3 independent queue entries will be created).

The Storage Commitment queue processing starts recurrently according to the configured time interval. All new entries (created between two queue runs) and existing pending entries are processed at that time. Queue entries are processed in the same order as they were initially entered.

The Apex AE issues Storage Commitment Requests using N-ACTION command. Each request is issued in a separate association. The Apex AE does not process N-EVENT-REPORT messages within the same association as N-ACTION Requests. N-EVENT-REPORT messages are processed in separate associations initiated by the SCP.

If an association cannot be established with the Storage Commitment SCP, the related queue entry is marked as pending. The Apex AE will retry sending Storage Commitment Requests for pending queue entries according to the configured settings. After exercising maximum number of retry attempt, the entry is marked as failed, and no further attempts will be performed.



Upon receiving the N-ACTION Response containing status Success, the entry is marked to wait for corresponding N-EVENT-REPORT results. If N-ACTION Response containing status other than Success, the entry is marked as failed and no further retry attempts will be performed.

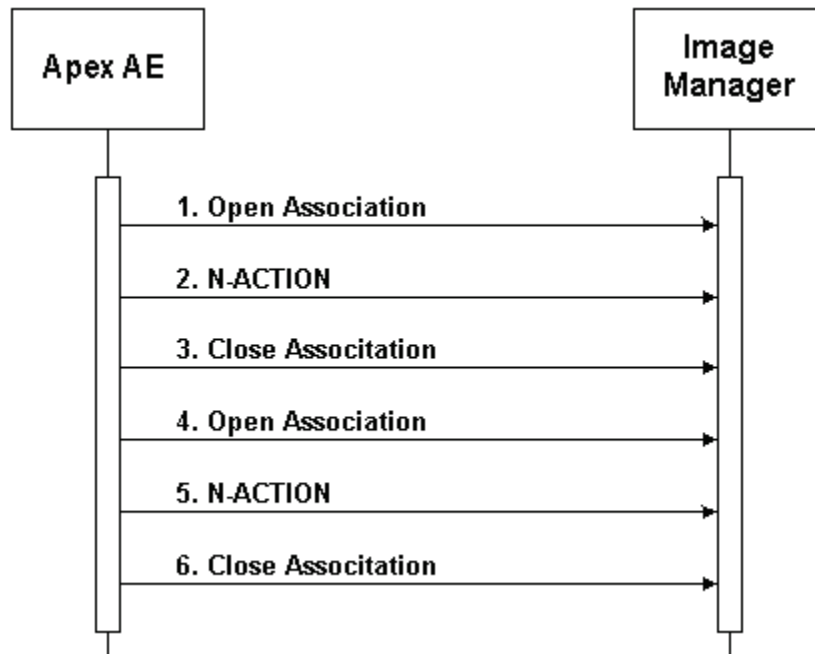

Figure 4.2-2. Sequencing of Activity – Storage Commitment

A possible sequence of interactions between the Apex AE and an Image Manager (e.g. a storage or archive device supporting the Storage Commitment SOP Classes as an SCP) is illustrated in Figure 4.2-1:

1. The Apex AE opens an association with the Image Manager.
2. An N-ACTION request is transmitted to the Image Manager to obtain storage commitment of previously transmitted SC images and GSPS instances. The Image Manager replies with a N-ACTION response indicating the request has been received and is being processed.
3. The Apex AE closes the association with the Image Manager.
4. The Apex AE opens another association with the Image Manager.
5. An N-ACTION request is transmitted to the Image Manager to obtain storage commitment of previously transmitted SC images and GSPS instances. The Image Manager replies with a N-ACTION response indicating the request has been received and is being processed.
6. The Apex AE closes the association with the Image Manager.

NOTE: Many other message sequences are possible depending on the number of SC images and GSPS instances to commit and configuration settings.

**4.2.1.3.2.2. Proposed Presentation Contexts**

**Table 4.2-9.**

**Proposed Presentation Contexts for Activity – Send Storage Commitment Request**

Abstract Syntax		Transfer Syntax		Role	Extended Negotiation
Name	UID	Name List	UID List		
Storage Commitment Push Model	1.2.840.10008.1.20.1	Implicit VR Little Endian	1.2.840.10008.1.2	SCU	None
		Explicit VR Little Endian	1.2.840.10008.1.2.1		
		Explicit VR Big Endian	1.2.840.10008.1.2.2		

**4.2.1.3.2.3. SOP Specific Conformance**

The behavior of Apex AE when encountering status codes in a C-STORE response is summarized in the table below:

**Table 4.2-10.**

**C-STORE Response Status Handling Behavior**

Service Status	Further Meaning	Error Code	Behavior
Success	Success	0000	Start waiting for incoming N-EVENT-REPORT message
Any other status codes			Job is marked as failed. Status code and contents of the Error Comment attribute (0000,0902) (if present) is logged and accessible via the UI. No further retry attempts will be performed.

The behavior of Apex AE during communication failure is summarized in the table below:

**Table 4.2-11.  
Communication Failure Behavior**

<b>Exception</b>	<b>Behavior</b>
Association cannot be established	Job is marked as pending. Failure reason is logged. Further retry attempts will be made until maximum retry number is reached, after which the job is marked as failed.
Timeout	
Association aborted by the SCP or network layers	

The Apex AE may issue N-ACTION Requests using Image-By-Image or Batch mode, according to the configuration settings. In Image-By-Image mode, a separate N-ACTION Request is issued for each SC image or GSPS instance. In Batch mode, an N-ACTION request is issued for a group of SC images and GSPS instances. If Batch mode is selected, then all images and GSPS instances sent for a group of scans selected by the user during a single DICOM Send operation, have the same Transaction UID (0008,1195) and are included into one N-ACTION Request.

#### **4.2.1.3.3. Activity – Worklist Update**

##### **4.2.1.3.3.1. Description and Sequencing of Activities**

The request for a Worklist Update is initiated by user interaction, i.e. pressing the buttons “Query” or ”Detailed Query”, or automatically according to the schedule, configurable by the user. With “Query” the automated query mechanism is performed immediately on request, while with “Detailed Query” a dialog to enter search criteria is opened and an interactive query can be performed.

The interactive Worklist Query will display a dialog for entering data as search criteria: Accession Number, Requested Procedure ID, Patient ID, and Patient Name. When the query is started on user request, only the data from the dialog will be inserted as matching keys into the query.

With automated worklist queries (including initiated by pressing the “Query” button) the Apex AE always requests all items for a procedure date range, Modality, and Scheduled Station AE Title. Each of these parameters is configurable by the user.

Upon initiation of the request, the Apex AE will build an identifier for the C-FIND request, will initiate an association to send the request and will wait for Worklist responses. After retrieval of each response, the Apex AE will access the local database to add or update patient demographic and procedure data. To protect the system from overflow, the Apex AE will limit the number of processed worklist responses to a configurable maximum. During receiving the worklist response items are counted and the query processing is stopped, by closing the association if the configurable limit of items is reached.

The Worklist results older than configured number of days will be cleared with the next Worklist update.

The Apex AE will initiate an association in order to issue a C-FIND request according to the Modality Worklist Information Model.

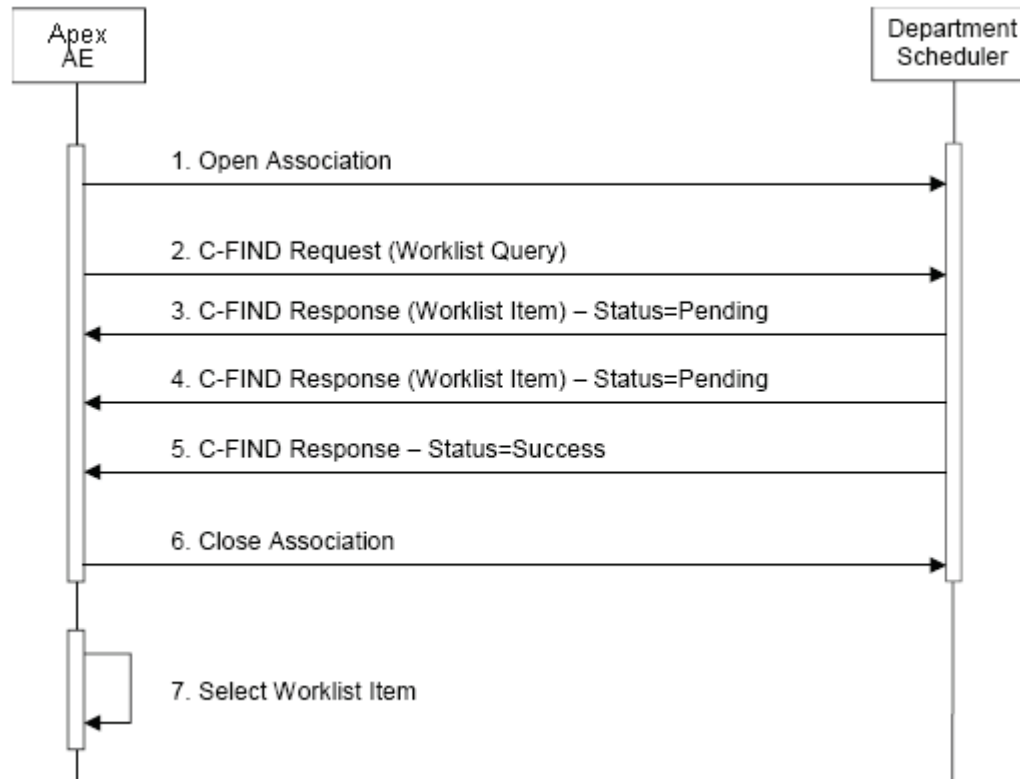

Figure 4.2-3. Sequencing of Activity – Worklist Update

A possible sequence of interactions between the Apex AE and a Departmental Scheduler (e.g. a device such as a RIS or HIS which supports the Modality Worklist SOP Class as an SCP) is illustrated in the Figure above:

1. The Apex AE opens an association with the Departmental Scheduler.
2. The Apex AE sends a C-FIND request to the Departmental Scheduler containing the Worklist Query attributes.
3. The Departmental Scheduler returns a C-FIND response containing the requested attributes of the first matching Worklist Item.
4. The Departmental Scheduler returns another C-FIND response containing the requested attributes of the second matching Worklist Item.
5. The Departmental Scheduler returns another C-FIND response with status Success indicating that no further matching Worklist Items exist. This example assumes that only 2 Worklist items match the Worklist Query.
6. The Apex AE closes the association with the Departmental Scheduler.
7. The user selects a Worklist Item from the Worklist and prepares to acquire new images.

**4.2.1.3.3.2. Proposed Presentation Contexts**

**Table 4.2-12.**

**Proposed Presentation Contexts for Activity – Worklist Update**

<b>Abstract Syntax</b>		<b>Transfer Syntax</b>		<b>Role</b>	<b>Extended Negotiation</b>
<b>Name</b>	<b>UID</b>	<b>Name List</b>	<b>UID List</b>		
Modality Worklist Find	1.2.840.10008.5.1.4.31	Implicit VR Little Endian	1.2.840.10008.1.2	SCU	None
		Explicit VR Little Endian	1.2.840.10008.1.2.1		
		Explicit VR Big Endian	1.2.840.10008.1.2.2		

**4.2.1.3.3.3. SOP Specific Conformance**

The following table describes the Apex AE behavior depending on Status Codes of messages received from the Worklist SCP.

**Table 4.2-13.**

**C-FIND Response Status Handling Behavior**

<b>Status</b>	<b>Status Code</b>	<b>Meaning</b>	<b>Apex Behavior</b>
Success	0000	Matching is complete – No final Identifier is supplied	Completes retrieving of matches
Pending	FF00	Matches are continuing – Current Match is supplied and any Optional Keys were supported in the same manner as Required Keys	Receiving of matches continues
Pending (No Optional Key Support)	FF01	Matches are continuing – Warning that one or more Optional Keys were not supported for existence for this Identifier	Receiving of matches continues without any warnings or errors
Other	Other	All other Status Codes	Terminates receiving of matches. Status code and contents of the Error Comment attribute (0000,0902) (if present) is logged.  If the query was initiated by the user, a failure message will be displayed.  Matches received prior to this code are handled normally.

The behavior of Apex AE during communication failure is summarized in the table below:

**Table 2-14.  
Communication Failure Behavior**

<b>Exception</b>	<b>Behavior</b>
Association cannot be established	Failure reason is logged.  If query was initiated by the user, a failure message is displayed and no further retries will be made.  If automatic query, no message displayed, and further retries will be made according to the configuration settings.
Timeout	Failure reason is logged.
Association aborted by the SCP or network layers	If query was initiated by the user, a failure message is displayed and no further retries will be made.  If automatic query, no message displayed, and further retries will be made according to the configuration settings.  Matches received prior to the failure are handled normally.
Receiving an invalid response or could not read the response	Error is logged, processing of bad response message is skipped, and the Apex proceeds to the next message.

Acquired images will always use the Study Instance UID specified for the Scheduled Procedure Step (if available). If an acquisition is unscheduled, a Study Instance UID will be generated locally.

The Table below provides a description of the Apex AE Worklist Request Identifier and specifies the attributes that are copied into the images. Unexpected attributes returned in a C-FIND response are ignored. Requested return attributes not supported by the SCP are set to have no value.

**Table 4.2-15.  
Worklist Request Identifier**

<b>Attribute Name</b>	<b>Tag</b>	<b>VR</b>	<b>M</b>	<b>Q</b>	<b>D</b>	<b>IOD</b>
Scheduled Procedure Step Module						
Scheduled Procedure Step Sequence	(0040,0100)	SQ				
>Scheduled Station AE Title	(0040,0001)	AE	S		x	
>Scheduled Station Name	(0040,0010)	SH				

## APEX Software DICOM Conformance Statement

Attribute Name	Tag	VR	M	Q	D	IOD
>Scheduled Procedure Step Location	(0040,0011)	SH			x	
>Scheduled Procedure Step Start Date	(0040,0002)	DA	R		x	
>Scheduled Procedure Step Start Time	(0040,0003)	TM				
>Scheduled Procedure Step End Date	(0040,0004)	DA				
>Scheduled Procedure Step End Time	(0040,0005)	TM				
>Scheduled Performing Physician's Name	(0040,0006)	PN			x	
>Scheduled Procedure Step Description	(0040,0007)	LO			x	x
>Scheduled Protocol Code Sequence	(0040,0008)	SQ			x	
>Scheduled Procedure Step ID	(0040,0009)	SH				x
>Scheduled Procedure Step Status	(0040,0020)	CS				
>Comments on the Scheduled Procedure Step	(0040,0400)	LT				
>Modality	(0008,0060)	CS	S			x
>Requested Contrast Agent	(0032,1070)	LO				
>Pre-Medication	(0040,0012)	LO				
<b>Requested Procedure Module</b>						
Requested Procedure ID	(0040,1001)	SH	*	x		x
Reason for the Requested Procedure	(0040,1002)	LO				
Requested Procedure Comments	(0040,1400)	LT			x	
Requested Procedure Code Sequence	(0032,1064)	SQ			x	
Study Instance UID	(0020,000D)	UI				x
Referenced Study Sequence	(0008,1110)	SQ				
Requested Procedure Description	(0032,1060)	LO			x	
Requested Procedure Priority	(0040,1003)	SH				
Patient Transport Arrangements	(0040,1004)	LO				
Requested Procedure Location	(0040,1005)	LO				
Confidentiality Code	(0040,1008)	LO				
Reporting Priority	(0040,1009)	SH				
Names of Intended Recipients of Results	(0040,1010)	PN			x	
<b>Imaging Service Request Module</b>						
Imaging Service Request Comments	(0040,2400)	LT			x	
Requesting Physician	(0032,1032)	PN			x	



## APEX Software DICOM Conformance Statement

Attribute Name	Tag	VR	M	Q	D	IOD
Referring Physician's Name	(0008,0090)	PN				
Requesting Service	(0032,1033)	LO			x	
Accession Number	(0008,0050)	SH	*	x	x	x
Issue Date of Imaging Service Request	(0040,2004)	DA				
Issue Time of Imaging Service Request	(0040,2005)	TM				
Placer Order Number	(0040,2016)	LO				
Filler Order Number	(0040,2017)	LO				
Order entered by ...	(0040,2008)	PN				
Order Enterer's Location	(0040,2009)	SH				
Order Callback Phone Number	(0040,2010)	SH				
<b>Visit Identification Module</b>						
Institution Name	(0008,0080)	LO				
Institution Address	(0008,0081)	ST				
Institution Code Sequence	(0008,0082)	SQ				
Admission ID	(0038,0010)	LO				
Issuer of Admission ID	(0038,0011)	LO				
<b>Visit Status Module</b>						
Visit Status ID	(0038,0008)	CS				
Current Patient Location	(0038,0300)	LO			x	
Patient's Institution Residence	(0038,0400)	LO				
Visit Comments	(0038,4000)	LT				
<b>Visit Admission Module</b>						
Referring Physician's Name	(0008,0090)	PN				
Referring Physician's Address	(0008,0092)	ST				
Referring Physician's Telephone Numbers	(0008,0094)	SH				
Admitting Diagnoses Description	(0008,1080)	LO				
Admitting Diagnoses Code Sequence	(0008,1084)	SQ				
Route of Admissions	(0038,0016)	LO				
Admitting Date	(0038,0020)	DA				
Admitting Time	(0038,0021)	TM				
<b>Visit Relationship Module</b>						
Referenced Patient Sequence	(0008,1120)	SQ				

## APEX Software DICOM Conformance Statement

Attribute Name	Tag	VR	M	Q	D	IOD
<b>Patient Identification Module</b>						
Patient's Name	(0010,0010)	PN	*	x		
Patient ID	(0010,0020)	LO	*	x		
Issuer of Patient ID	(0010,0021)	LO				
Other Patient IDs	(0010,1000)	LO		x		x
Other Patient Names	(0010,1001)	PN				
Patient's Birth Name	(0010,1005)	PN				
Patient's Mother's Birth Name	(0010,1060)	PN				
Medical Record Locator	(0010,1090)	LO				
<b>Patient Demographic Module</b>						
Patient's Age	(0010,1010)	AS				
Occupation	(0010,2180)	SH				
Confidentiality Constraint on Patient Data Description	(0040,3001)	LO				
Patient's Birth Date	(0010,0030)	DA			x	
Patient's Birth Time	(0010,0032)	TM				
Patient's Sex	(0010,0040)	CS			x	
Patient's Insurance Plan Code Sequence	(0010,0050)	SQ				
Patient's Size	(0010,1020)	DS				
Patient's Weight	(0010,1030)	DS				
Patient's Address	(0010,1040)	LO				
Military Rank	(0010,1080)	LO				
Branch of Service	(0010,1081)	LO				
Country of Residence	(0010,2150)	LO				
Region of Residence	(0010,2152)	LO				
Patient's Telephone Numbers	(0010,2154)	SH				
Ethnic Group	(0010,2160)	SH			x	
Patient's Religious Preference	(0010,21F0)	LO				
Patient Comments	(0010,4000)	LT			x	
<b>Patient Medical Module</b>						
Medical Alerts	(0010,2000)	LO			x	
Contrast Allergies	(0010,2110)	LO				

## APEX Software DICOM Conformance Statement

Attribute Name	Tag	VR	M	Q	D	IOD
Smoking Status	(0010,21A0)	CS				
Pregnancy Status	(0010,21C0)	US			x	
Last Menstrual Date	(0010,21D0)	DA				
Special Needs	(0038,0050)	LO				
Patient State	(0038,0500)	LO				
Patient Relationship Module						
Referenced Visit Sequence	(0008,1125)	SQ				
Referenced Patient Alias Sequence	(0038,0004)	SQ				

The above table should be read as follows:

- **Attribute Name:** Attributes supported to build an Apex Modality Worklist Request Identifier.
- **Tag:** DICOM tag for this attribute.
- **VR:** DICOM VR for this attribute.
- **M:** Matching keys for Worklist Update. A "S" will indicate that Apex will supply an attribute value for Single Value Matching, a "R" will indicate Range Matching and a "\*" will denote wildcard matching..
- **Q:** Interactive Query Key. An "x" will indicate that Apex will supply this attribute as matching key, if entered in the Detailed Worklist Query dialog.
- **D:** Displayed keys. An "x" indicates that this worklist attribute is displayed to the user. (Also see note 1 below.)
- **IOD:** An "x" indicates that this Worklist attribute is included into all Object Instances created during performance of the related Procedure Step. (Also see note 2 below.)

**Note 1.** There are fields displayed by Apex, that can be mapped to any of the Worklist Return Keys:

- Patient Name
- Patient ID
- Patient ID2
- Ethnicity
- Patient Date of Birth
- Sex
- Patient Weight
- Patient Height

- Referring Physician
- Procedure Code
- Study Name
- Start Date
- 3 HL7 fields

The Patient ID filed serves for Apex as a primary key to identify a patient, so it should be mapped to an attribute containing unique value for each patient, typically Patient ID attribute (0010,0020).

**Note 2.** There are fields included by Apex into Object Instances that can be mapped to any of the Worklist Return Keys:

- Patient Name
- Patient ID
- Ethnicity
- Patient Date of Birth
- Patient Sex
- Referring Physician

**Note 3.** All attributes other than Matching Keys serve as Return Keys. In addition, all Matching Keys without assigned values also serve as Return Keys.

**Note 4.** There is a field used by Apex as a primary key to identify a procedure. It is configurable to use Accession Number (0008,0050) or Study Instance UID (0008,1110) attribute.

#### **4.2.1.3.4. Activity – Acquire Images**

##### **4.2.1.3.4.1. Description and Sequencing of Activities**

An MPPS SOP Instance is created when the user starts acquiring images for a study selected from Worklist. (See section 4.1.2.1.4 for description of the conditions). The Apex AE initiates an association with MPPS SCP, issues N-CREATE Request with status “IN PROGRESS” and closes the association.

An MPPS SOP Instance is updated when the user acquires all images for a study (“COMPLETED”) or aborts the study (“DISCONTINUED”). The Apex AE initiates an association with MPPS SCP, issues N-SET Request with status “IN PROGRESS” and closes the association.

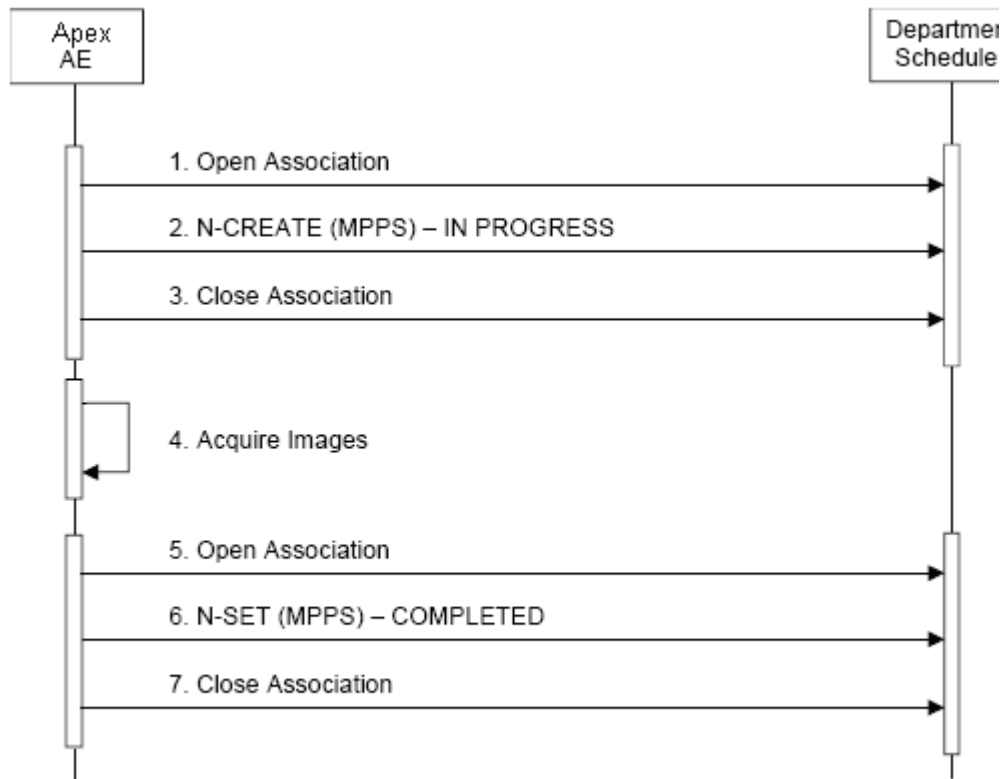

Figure 4.2-4. Sequencing of Activity – Acquire Images

A possible sequence of interactions between the Apex AE and a Departmental Scheduler (e.g. a device such as a RIS or HIS which supports the MPPS SOP Class as an SCP) is illustrated in Figure 4.2-4:

1. The Apex AE opens an association with the Departmental Scheduler.
2. The Apex AE sends an N-CREATE request to the Departmental Scheduler to create an MPPS instance with status of “IN PROGRESS” and create all necessary attributes. The Departmental Scheduler acknowledges the MPPS creation with an N-CREATE response (status success).
3. The Apex AE closes the association with the Departmental Scheduler.
4. All images are acquired and stored in the local database.
5. The Apex AE opens an association with the Departmental Scheduler.
6. The Apex AE sends an N-SET request to the Departmental Scheduler to update the MPPS instance with status of “COMPLETED” and set all necessary attributes. The Departmental Scheduler acknowledges the MPPS update with an N-SET response (status success).
7. The Apex AE closes the association with the Departmental Scheduler.

**4.2.1.3.4.2. Proposed Presentation Contexts**

**Table 4.2-16.**

**Proposed Presentation Contexts for Activity – Acquire Images**

Abstract Syntax		Transfer Syntax		Role	Extended Negotiation
Name	UID	Name List	UID List		
Modality Performed Procedure Step	1.2.840.10008.3.1.2.3.3	Implicit VR Little Endian	1.2.840.10008.1.2	SCU	None
		Explicit VR Little Endian	1.2.840.10008.1.2.1		
		Explicit VR Big Endian	1.2.840.10008.1.2.2		

**4.2.1.3.4.3. SOP Specific Conformance**

The following table describes the Apex AE behavior depending on Status Codes of messages received from the MPPS SCP.

**Table 4.2-17.**

**N-CREATE / N-SET Response Status Handling Behavior**

Service Command	Status	Error Code	Behavior
N-CREATE	Success	0000	No action. Ready to send N-SET
	Any other status codes		Job is marked as failed. Status code and contents of the Error Comment attribute (0000,0902) (if present) is logged. No subsequent N-SET command will be issued.  No message displayed to the user.
N-SET	Success	0000	No action
	Any other status codes		Job is marked as failed. Status code and contents of the Error Comment attribute (0000,0902) (if present) is logged.  No message displayed to the user.

The behavior of Apex AE during communication failure is summarized in the table below:

**Table 4.2-18.**

**Communication Failure Behavior**

<b>Exception</b>	<b>Behavior</b>
Association cannot be established	Job is marked as failed. Failure reason is logged. No message displayed to the user.
Timeout	
Association aborted by the SCP or network layers	

Table below provides a description of the MPPS N-CREATE and N-SET request identifiers sent by Apex modality. Empty cells in the N-CREATE and N-SET columns indicate that the attribute is not sent. A “Zero Length” attribute will be sent with zero length. A “WL” indicates that a value will be populated from a corresponding attribute of Modality Worklist.

**Table 4.2-19.**

**N-CREATE / N-SET Request Identifier**

<b>Attribute Name</b>	<b>Tag</b>	<b>VR</b>	<b>N-CREATE</b>	<b>N-SET</b>
<b>Performed Procedure Step Relationship Module</b>				
Patient's Name	(0010,0010)	PN	WL	
Patient ID	(0010,0020)	LO	WL	
Patient's Birth Date	(0010,0030)	DA	WL	
Patient's Sex	(0010,0040)	CS	WL	
Referenced Patient Sequence	(0008,1120)	SQ	WL	
Scheduled Step Attributes Sequence	(0040,0270)	SQ	WL	
>Study Instance UID	(0020,000D)	UI	WL	
>Referenced Study Sequence	(0008,1110)	SQ	WL	
>Accession Number	(0008,0050)	SH	WL	
>Placer Order Number	(0040,2016)	LO	WL	
>Filler Order Number	(0040,2017)	LO	WL	
>Requested Procedure ID	(0040,1001)	SH	WL	
>Requested Procedure Description	(0032,1060)	LO	WL	

## APEX Software DICOM Conformance Statement

Attribute Name	Tag	VR	N-CREATE	N-SET
>Scheduled Procedure Step ID	(0040,0009)	SH	WL	
>Scheduled Procedure Step Description	(0040,0007)	LO	WL	
>Scheduled Protocol Code Sequence	(0040,0008)	SQ	WL	
<b>Performed Procedure Step Information Module</b>				
Performed Station AE Title	(0040,0241)	AE	From Configuration	
Performed Station Name	(0040,0242)	SH	Zero Length	
Performed Location	(0040,0243)	SH	Zero Length	
Performed Procedure Step Start Date	(0040,0244)	DA	Actual Start Date	
Performed Procedure Step Start Time	(0040,0245)	TM	Actual Start Time	
Performed Procedure Step ID	(0040,0253)	SH	See Note 1	
Performed Procedure Step End Date	(0040,0250)	DA	Zero Length	Actual End Date
Performed Procedure Step End Time	(0040,0251)	TM	Zero Length	Actual End Time
Performed Procedure Step Status	(0040,0252)	CS	IN PROGRESS	COMPLETED or DISCONTINUED
Performed Procedure Step Description	(0040,0254)	LO	Zero Length	
Performed Procedure Type Description	(0040,0255)	LO	Zero Length	
Procedure Code Sequence	(0008,1032)	SQ	Zero Length	
<b>Image Acquisition Results Module</b>				
Modality	(0008,0060)	CS	WL	
Study ID	(0020,0010)	SH	Zero Length	
Performed Protocol Code Sequence	(0040,0260)	SQ	Zero Length	



## APEX Software DICOM Conformance Statement

Attribute Name	Tag	VR	N-CREATE	N-SET
Performed Series Sequence	(0040,0340)	SQ	Zero Length	
>Performing Physician's Name	(0008,1050)	PN		Zero Length
>Protocol Name	(0018,1030)	LO		"NA"
>Operators' Name	(0008,1070)	PN		Zero Length
>Series Instance UID	(0020,000E)	UI		Generated by Apex
>Series Description	(0008,103E)	LO		Zero Length
>Retrieve AE Title	(0008,0054)	AE		Zero Length
>Referenced Image Sequence	(0008,1140)	SQ		Zero Length
>Referenced Non-Image Composite SOP Instance Sequence	(0040,0220)	SQ		Zero Length
<b>Radiation Module</b>				
Image Area Dose Product	(0018,115E)	DS	Zero Length	Actual Value
Exposure Dose Sequence	(0040,030E)		Zero Length	
>KVP	(0018,0060)		N/A	Actual Value
>Xray Tube Current in uA	(0018,8151)		N/A	Actual Value
>Exposure Time	(0018,1150)		N/A	Actual Value
Number of Exposures	(0040,0301)		Zero Length	Actual Value
Distance Source to Detector	(0018,1110)		Zero Length	Actual Value
Exposure	(0018,1152)		Zero Length	Actual Value
Entrance Dose in mGy	(0040,8302)		Zero Length	Actual Value

Note 1. Performed Procedure Step ID attribute is populated from the Worklist attribute mapped to the Apex field "Procedure Code".

Each Modality Performed Procedure Step is uniquely identified by Affected SOP Instance UID attribute (0000,1000). It is generated by Apex when MPPS Instance is created.

### 4.2.1.3.5. Activity - Query Remote AE

#### 4.2.1.3.5.1. Description and Sequencing of Activities

The user initiates Query from the Query Retrieve screen. The user may select a single Remote AE from the list of configured multiple Query SCPs.

The Apex AE initiates an association with the Query Retrieve SCP. Once the association has been established, the Apex sends a C-FIND request according to the user-configured parameters and waits for transmission of conformant Query service messages. The association is closed after retrieving the last message or in case of error. Received study information is displayed to the user.

Query is performed on Study level only.

Only a single attempt is be made to query the remote AE. If the query fails, for whatever reason, no retry will be performed.

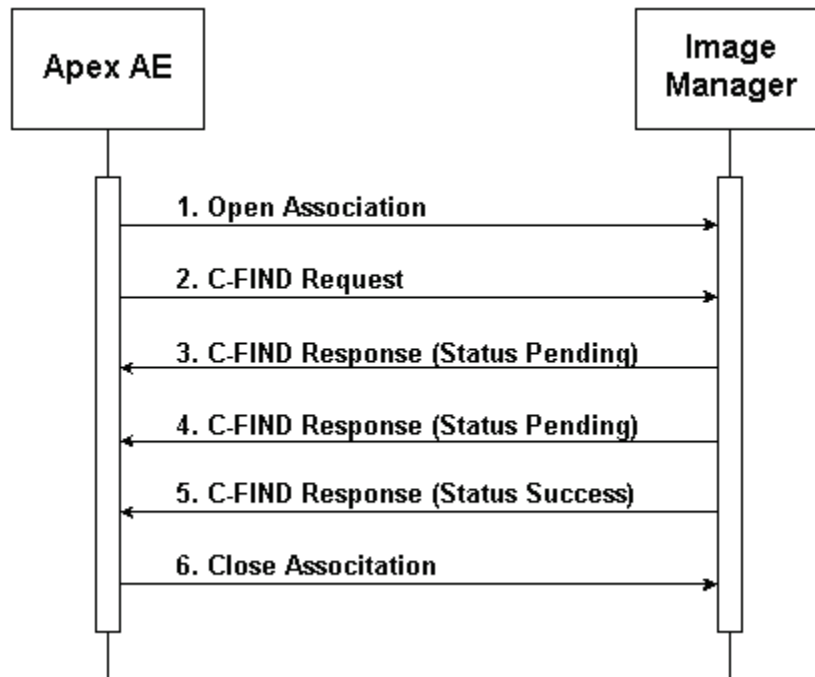

Figure 4.2-5. Sequencing of Activity – Query Remote AE

A possible sequence of interactions between the Apex AE and an Image Manager (e.g. a storage or archive device supporting the Query Retrieve SOP Classes as an SCP) is illustrated in the Figure above:

1. The Apex AE opens an association with the Image Manager.
2. The Apex AE sends a C-FIND request to the Image Manager containing the Query attributes.
3. The Image Manager returns a C-FIND response containing the requested attributes of the first matching study.

4. The Image Manager returns another C-FIND response containing the requested attributes of the second matching study.
5. The Image Manager returns another C-FIND response with status Success, indicating that no further matching studies exist. This example assumes that only 2 studies match the Query criteria.
6. The Apex AE closes the association with the Image Manager.

**4.2.1.3.5.2. Proposed Presentation Contexts**

**Table 4.2-20.**

**Proposed Presentation Contexts for Activity – Query Remote AE**

Abstract Syntax		Transfer Syntax		Role	Extended Negotiation
Name	UID	Name List	UID List		
Study Root Query/Retrieve Model – FIND	1.2.840.10008.5.1.4.1.2.2.1	Implicit VR Little Endian	1.2.840.10008.1.2	SCU	None
		Explicit VR Little Endian	1.2.840.10008.1.2.1		
		Explicit VR Big Endian	1.2.840.10008.1.2.2		

**4.2.1.3.5.3. SOP Specific Conformance**

The following attributes may be entered by the user and used in Study Root Query request. (Only Study Level keys are supported.)

**Table 4.2-21.**

**Study Root Request Identifier**

Attribute Name	Tag	Types of Matching
Patient ID	0010, 0020	S, *, U
Patient's Name	0010, 0010	S, *, U
Patient's Birth Date	0010, 0030	S
Study Date	0008, 0020	R
Study Time	0008, 0030	S
Accession Number	0008, 0050	S, *, U
Study ID	0020, 0010	S, *, U
Study Instance UID	0020, 000D	S
Referring Physician's Name	0008, 0090	S, *, U
Modalities In Study	0008, 0061	S

Types of Matching: An "S" indicates the identifier attribute uses Single Value Matching, an "R" indicates Range Matching, an "\*" indicates wildcard matching, and a 'U' indicates Universal Matching.

The following table describes Apex behavior depending on Status Codes of messages received from the SCP.

**Table 4.2-22.**

**C-FIND Response Status Handling Behavior**

<b>Status</b>	<b>Status Code</b>	<b>Meaning</b>	<b>Apex Behavior</b>
Success	0000	Matching is complete – No final Identifier is supplied	Completes retrieving of matches
Pending	FF00	Matches are continuing – Current Match is supplied, and any Optional Keys were supported in the same manner as Required Keys	Receiving of matches continues
Pending (No Optional Key Support)	FF01	Matches are continuing – Warning that one or more Optional Keys were not supported for existence for this Identifier	Receiving of matches continues without any warnings or errors
Other	Other	All other Status Codes	Terminates receiving of matches. Status code and contents of the Error Comment attribute (0000,0902) (if present) is logged. Error message is displayed.  Matches received prior to this code are handled normally.

The behavior of Apex AE during communication failure is summarized in the table below:

**Table 4.2-23.**

**Communication Failure Behavior**

<b>Exception</b>	<b>Behavior</b>
Association cannot be established	Error is logged. Error message is displayed.
Timeout	Error is logged. Error message is displayed.
Association aborted by the SCP or network layers	Matches received prior to this code are handled normally.

#### **4.2.1.3.6. Activity – Retrieve from Remote AE**

##### **4.2.1.3.6.1. Description and Sequencing of Activities**

The user initiates Retrieve requests via the User Interface in two ways.

1. The user makes a selection from the entries displayed on the Query Retrieve screen as result of last Query Request, and presses the Retrieve button. Retrieve Request is performed on Study level. Study Instance UIDs obtained during the Query Request are used as Request Identifiers.

The Apex AE opens an association with the same Remote AE that was used for Query Request. A separate C-MOVE Request is issued for each study. Upon processing C-MOVE Requests for all selected studies, the Apex AE closes the association.

The Apex displays number of retrieved studies on the Query Retrieve screen and is updates it each time when new study is retrieved.

2. The user makes a selection from the entries displayed on the Locate screen and presses the Restore button. Retrieve Request is performed on Series level using the information stored in the local database.

The Apex may be configured to use a Storage SCP as an archive location. In this case, a separate Retrieve SCP may be associated with this Storage SCP, and subsequent Retrieve Requests will be issued to that Retrieve SCP. If no Retrieve SCP is associated with a Storage SCP, then the Storage SCP is used also as a Retrieve SCP.

Upon successful completion of a Storage Request to an archive location, the network parameters of the Retrieve SCP, Study Instance UID, and Series Instance UID of the sent image are stored in the local database.

When the user initiates the Retrieve request, the Apex AE tries to establish an association with Remote AE using network parameters stored in the local database for images being retrieved. If the association cannot be established, the Apex AE searches for the network parameters for this Remote AE in the currently configured list of Retrieve SCPs, and tries to open an association using this data. If the association cannot be established, the Apex AE searches for the network parameters for this Remote AE in the currently configured list of Storage SCPs, and tries to open an association using this data.

Upon establishing the association, the Apex AE issues a separate C-MOVE Request for each Series. Upon processing C-MOVE Requests for all selected images, the Apex AE closes the association.

Study Instance UID and Series Instance UID stored in the local database are used as Request Identifier.

The Retrieve Requests are issued at the background, without further interaction with the user.

In both cases, if Retrieve Request fails for any reason, it is placed in the queue for subsequent retries according to the configuration settings. The user may monitor status of Retrieve Requests and delete them from the queue via the View Queue screen.

The Apex AE Title is used as Move Destination. The Apex AE accepts associations from Retrieve SCP and processes received C-STORE Requests.

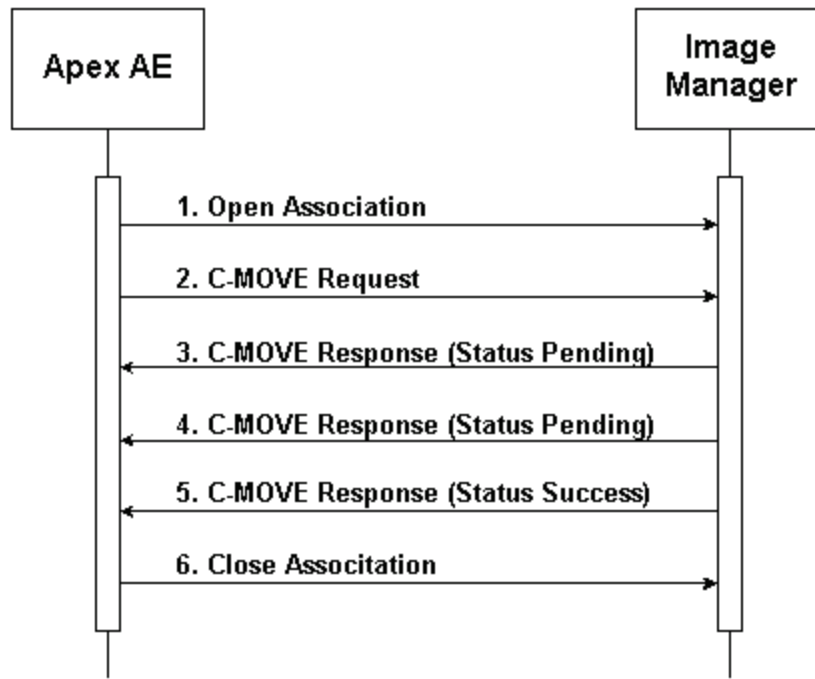

Figure 4.2-6. Sequencing of Activity – Retrieve from Remote AE

A possible sequence of interactions between the Apex AE and an Image Manager (e.g. a storage or archive device supporting the Query Retrieve SOP Classes as an SCP) is illustrated in the Figure above:

1. The Apex AE opens an association with the Image Manager.
2. The Apex AE sends a C-MOVE request to the Image Manager containing the Request Identifier.
3. The Image Manager returns a C-MOVE response containing the status of moving images for a specified study or series.
4. The Image Manager returns another C-MOVE response containing the updated status of moving images for a specified study or series.
5. The Image Manager returns another C-MOVE response with status Success, indicating that moving is completed.
6. The Apex AE closes the association with the Image Manager.

**4.2.1.3.6.2. Proposed Presentation Contexts**

**Table 4.2-24.**

**Proposed Presentation Contexts for Activity – Retrieve from Remote AE**

Abstract Syntax		Transfer Syntax		Role	Extended Negotiation
Name	UID	Name List	UID List		
Study Root Query/Retrieve Model - MOVE	1.2.840.10008.5.1.4.1.2.2.2	Implicit VR Little Endian	1.2.840.10008.1.2	SCU	None
		Explicit VR Little Endian	1.2.840.10008.1.2.1		
		Explicit VR Big Endian	1.2.840.10008.1.2.2		

**4.2.1.3.6.3. SOP Specific Conformance**

The table below describes Study Root Request Identifier:

**Table 4.2-25.**

**C-MOVE Request Identifier**

Attribute Name	Tag	Unique, Matching, or Return Key
Study Level		
Study Instance UID	(0020,000D)	U
Series Level		
Study Instance UID	(0020,000D)	M
Series Instance UID	(0020,000E)	U



The following table describes Apex behavior depending on Status Codes of messages received from the SCP.

**Table 4.2-26.**

**C-MOVE Response Status Handling Behavior**

<b>Status</b>	<b>Status Code</b>	<b>Meaning</b>	<b>Apex Behavior</b>
Success	0000	All instances are retrieved successfully	Updates retrieve status if running on the foreground, otherwise no action.
Pending	FF00	Continuing retrieving instances.	Updates retrieve status if running on foreground, otherwise no action.
Other	Other	All other Status Codes	A list of ailed SOP Instance UIDs, status code, and contents of the Error Comment attribute (0000,0902) (if present) is logged.  Studies retrieved prior to this code are handled normally.

The behavior of Apex AE during communication failure is summarized in the table below:

**Table 4.2-27.**

**Communication Failure Behavior**

<b>Exception</b>	<b>Behavior</b>
Association cannot be established	Error is logged. Error message is displayed if running on the foreground.
Timeout	Error is logged. Matches received prior to this code are handled normally. Error message is displayed if running on the foreground.
Association aborted by the SCP or network layers	

#### 4.2.1.3.7. Activity – Send Verification Request

##### 4.2.1.3.7.1. Description and Sequencing of Activities

The Apex AE initiates an association with the Verification SCP by the user request and issues the C-ECHO command.

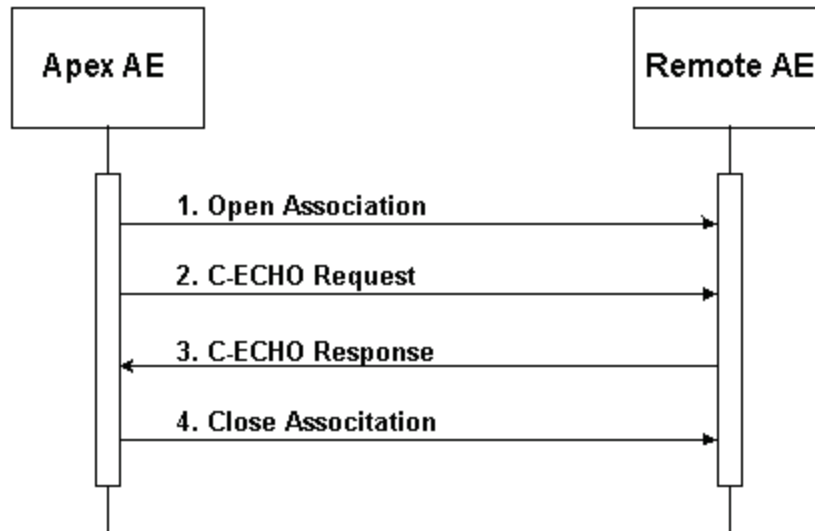

Figure 4.2-7. Sequencing of Activity – Retrieve from Remote AE

A possible sequence of interactions between the Apex AE and a Remote AE is illustrated in the Figure above:

1. The Apex AE opens an association with the Remote AE.
2. The Apex AE sends a C-ECHO request to the Remote AE
3. The Remote AE returns a C-ECHO response.
4. The Apex AE closes the association with Remote AE.

**4.2.1.3.7.2. Proposed Presentation Contexts**

**Table 4.2-28.**

**Proposed Presentation Contexts for Activity – Send Verification Request**

Abstract Syntax		Transfer Syntax		Role	Extended Negotiation
Name	UID	Name List	UID List		
Verification	1.2.840.10008.1.1	Implicit VR Little Endian	1.2.840.10008.1.2	SCU	None
		Explicit VR Little Endian	1.2.840.10008.1.2.1		
		Explicit VR Big Endian	1.2.840.10008.1.2.2		

**4.2.1.4. Association Acceptance Policy**

The Apex AE accepts associations for the Real-World Activities:

- Storage
- Storage Commitment
- Verification

The Apex AE may reject associations as shown in the table below:

**Table 4.2-29.**

**Association Rejection Reasons**

<b>Result</b>	<b>Reason/Diag</b>	<b>Explanation</b>
2 – rejected-transient	2 – local-limit-exceeded	The (configurable) maximum number of simultaneous associations has been reached. An association request with the same parameters may succeed at a later time.
1 – rejected-permanent	1 – no-reason-given	The association request could not be parsed. An association request with the same format will not succeed at a later time.

#### 4.2.1.4.1. Activity – Receive Storage Commitment Response

##### 4.2.1.4.1.1. Description and Sequencing of Activities

The Apex AE will accept associations in order to receive responses to a Storage Commitment Request.

All Storage Commitment queue entries corresponding to SOP Instance UIDs contained in the Referenced SOP Sequence (0008, 1199) will be marked as successfully committed.

All Storage Commitment queue entries corresponding to SOP Instance UIDs contained in the Failed SOP Sequence (0008, 1198) will be marked as failed.

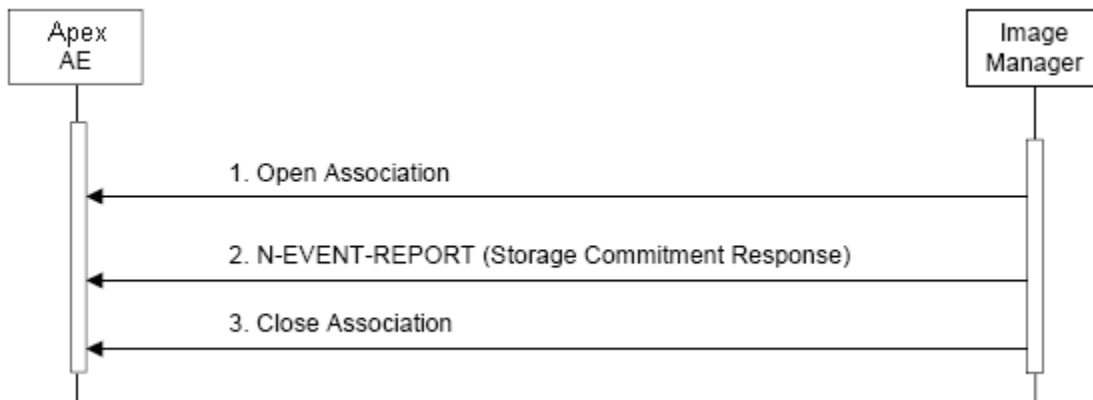

Figure 4.2-8. Sequencing of Activity – Receive Storage Commitment Response

A possible sequence of interactions between the Apex AE and an Image Manager (e.g. a storage or archive device supporting Storage Commitment SOP Classes as an SCP) is illustrated in the Figure above:

1. The Image Manager opens a new association with the Apex AE.
2. The Image Manager sends an N-EVENT-REPORT request notifying the Apex AE of the status of a previous Storage Commitment Request. The Apex AE replies with a N-EVENT-REPORT response confirming receipt.
3. The Image Manager closes the association with the Apex AE.

**4.2.1.4.1.2. Proposed Presentation Contexts**

**Table 4.2-30.**

**Acceptable Presentation Contexts for Activity – Receive Storage Commitment Response**

Abstract Syntax		Transfer Syntax		Role	Extended Negotiation
Name	UID	Name List	UID List		
Storage Commitment Push Model	1.2.840.10008.1.20.1	Implicit VR Little Endian	1.2.840.10008.1.2	SCU	None
		Explicit VR Little Endian	1.2.840.10008.1.2.1		
		Explicit VR Big Endian	1.2.840.10008.1.2.2		

**4.2.1.4.1.3. SOP Specific Conformance**

The Apex AE supports following attributes used in N-EVENT-REPORT message received from the SCP:

**Table 4.2-31.**

**Supported Attributes for N-EVENT-REPORT Request**

Attribute Name	Attribute Tag
Transaction UID	0008,1195
Retrieve AE Title	0008,0054
Referenced SOP Sequence	0008, 1199
>Referenced SOP Class UID	0008,1150
>Referenced SOP Instance UID	0008,1155
Failed SOP Sequence	0008,1198
>Referenced SOP Class UID	0008,1150
>Referenced SOP Instance UID	0008,1155

The following table describes Status Codes that Apex sends back to the SCP:

**Table 4.2-32.**

**N-EVENT\_REPORT Response Status Reasons**

Status	Status Code	Meaning
Success	0000	N-EVENT-REPORT processed successfully
Failure	C000	All types of failure. Error Comment attribute (0000,0902) is populated with error description. Error is logged.

#### 4.2.1.4.2. Activity – Retrieve Images

##### 4.2.1.4.2.1. Description and Sequencing of Activities

Upon sending a C-MOVE request to the Query/Retrieve SCP, the Apex AE waits for associations with C-STORE request messages from the SCP. It accepts the associations and sends back C-STORE response messages.

Upon receiving and accepting a C-STORE request, the Apex AE parses received DICOM message. If the message contains private Apex scan data, the application extracts it and restores the Apex scan into the system. The rest of the DICOM message content is discarded.

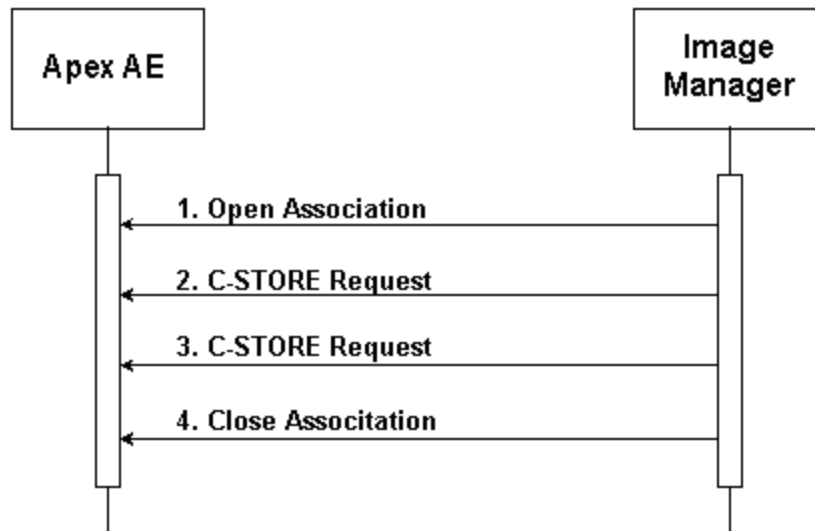

Figure 4.2-9 Sequencing of Activity – Retrieve Images

A possible sequence of interactions between the Apex AE and an Image Manager is illustrated in the Figure above:

1. The Image Manager opens a new association with the Apex AE.
2. The Image Manager transmits an SC Image using C-STORE Request and receives from Apex a C-STORE Response with status Success.
3. The Image Manager transmits another SC Image using C-STORE Request and receives from Apex a C-STORE Response with status Success.
4. The Image Manager closes the association with the Apex AE.

**4.2.1.4.2.2. Proposed Presentation Contexts**

**Table 4.2-33.**

**Acceptable Presentation Contexts for Activity – Retrieve Images**

Abstract Syntax		Transfer Syntax		Role	Extended Negotiation
Name	UID	Name List	UID List		
Secondary Capture Image Storage	1.2.840.10008.5.1.4.1.1.7	Implicit VR Little Endian	1.2.840.10008.1.2	SCU	None
		Explicit VR Little Endian	1.2.840.10008.1.2.1		
		Explicit VR Big Endian	1.2.840.10008.1.2.2		

**4.2.1.4.2.3. SOP Specific Conformance**

Apex application uses following attributes of the C-STORE request message. (The rest of the attributes are ignored.)

**Table 4.2-34.**

**Supported Attributes for C-STORE Request**

Attribute Name	Tag	Notes
Manufacturer	0008, 0070	Note 1
Study Instance UID	0020, 000D	
Series Instance UID	0020, 000E	
Date of Secondary Capture	0018, 0012	
Time of Secondary Capture	0018, 0014	
Image Comments	0020, 4000	
Private Creator Data Element	0023, 0010	Note 1
Encoding Scheme Version	0023, 1000	
P File Name	0023, 1001	
P File Data	0023, 1002	
P File Length	0023, 1003	
R File Data	0023, 1004	
R File Length	0023, 1005	



Note 1. The expected value is “HOLOGIC”. In case of any other value the file is ignored.

The following table describes Status Codes that Apex sends back to SCP:

**Table 4.2-35.  
S-STORE Response Status Reasons**

<b>Status</b>	<b>Status Code</b>	<b>Meaning</b>
Success	0000	C-STORE processed successfully
Failure	C000	All types of failure. Error Comment attribute (0000,0902) is populated with error description. The error is logged.

#### 4.2.1.4.3. Activity – Receive Verification Request

##### 4.2.1.4.3.1. Description and Sequencing of Activities

The Apex AE accepts an association from the Verification SCU, receives the C-ECHO Request and issues the C-ECHO Response.

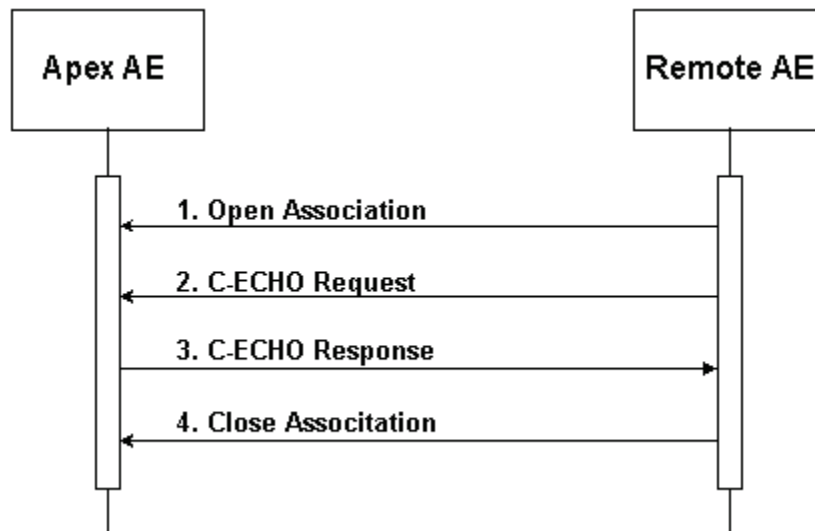

Figure 4.2-10 Sequencing of Activity – Receive Verification Request

A possible sequence of interactions between the Apex AE and a Remote AE is illustrated in the Figure above:

1. The Remote AE opens a new association with the Apex AE.
2. The Remote AE sends a C-ECHO Request.
3. The Apex AE sends a C-ECHO Response.
4. The Remote AE closes the association with the Apex AE.

**4.2.1.4.3.2. Proposed Presentation Contexts**

**Table 4.2-36.**

**Acceptable Presentation Contexts for Activity – Receive Verification Request**

Abstract Syntax		Transfer Syntax		Role	Extended Negotiation
Name	UID	Name List	UID List		
Verification	1.2.840.10008.1.1	Implicit VR Little Endian	1.2.840.10008.1.2	SCU	None
		Explicit VR Little Endian	1.2.840.10008.1.2.1		
		Explicit VR Big Endian	1.2.840.10008.1.2.2		

**4.3. Network Interfaces**

**4.3.1. Supported Communication Stacks**

DICOM Upper Layer (PS 3.8.) is supported using TCP/IP.

**4.3.2. TCP/IP Stack**

The TCP/IP stack is inherited from the operating system on which it is running.

**4.3.3. Physical Media Support**

The physical medium is inherited from the computer on which it is running.

## 4.4. Configuration

### 4.4.1. AE Title / Presentation Address Mapping

#### 4.4.1.1. Local AE Title / Presentation Address Mapping

The local application AE Title and listening TCP/IP port is user configurable via the Apex System Configuration screen.

#### 4.4.1.2. Remote AE Title / Presentation Address Mapping

The remote applications AE Titles and listening TCP/IP ports are user configurable via the Apex System Configuration screen.

##### 4.4.1.2.1. Storage

The user may configure Storage SCP AE Title, IP Address/Host Name, Port Number, and Destination Name. Multiple Storage SCPs can be defined. The Destination Name should be unique for each defined Storage SCP.

A Storage SCP can be configured to use Storage Commitment, causing storage commitment to be requested for images or presentation states transmitted to the device. Existing (already defined) Storage Commitment SCP can be associated with the Storage SCP, or a new one may be added. Storage Commitment Requests will be issued to the Storage Commitment SCP associated with the Storage SCP. Storage Commitment SCP is configured separately and can have the same AE Title / Presentation Address as the Storage SCP, or different AE Title / Presentation Address.

A Storage SCP can be configured to be an “archive location”. In this case, Apex scans can be retrieved from the archive location using Query Retrieve. Existing (already defined) Query Retrieve SCP can be associated with the Storage SCP, or a new one may be added. Subsequent Retrieve Requests will be issued to the Query Retrieve SCP associated with the Storage SCP. Query Retrieve SCP is configured separately and can have the same AE Title / Presentation Address as the Storage SCP, or different AE Title / Presentation Address. If a Storage SCP is configured as “archive location” and no Query Retrieve SCP is associated with it, then subsequent Retrieve Requests will be issued to the Storage SCP.

##### 4.4.1.2.2. Storage Commitment

The user may configure Storage Commitment SCP AE Title, IP Address/Host Name, Port Number, and Destination Name. Multiple Storage Commitment SCPs can be defined. The Destination Name should be unique for each defined Storage Commitment SCP.

### 4.4.1.2.3. Query Retrieve

The user may configure Query Retrieve SCP AE Title, IP Address/Host Name, and Port Number. Multiple Query Retrieve SCPs can be defined. The AE Title should be unique for each defined Query Retrieve SCP.

### 4.4.1.2.4. Modality Worklist

The user may configure Worklist SCP AE Title, IP Address/Host Name, and Port Number. Only one Worklist SCP can be defined.

A Worklist SCP can be configured to enable Modality Performed Procedure Step. MPPS SCP is configured separately and can have the same AE Title / Presentation Address as the Worklist SCP, or different AE Title / Presentation Address.

### 4.4.1.2.5. Modality Performed Procedure Step

The user may configure MPPS SCP AE Title, IP Address/Host Name, and Port Number. Only one MPPS SCP can be defined.

## 4.4.2. Parameters

The table below describes parameters that can be configured by the user for Storage, Storage Commitment, and Query Retrieve activities.

**Table 4.4-1.**

**User Configurable Parameters for Storage, Storage Commitment, and Query Retrieve**

<b>Category</b>	<b>For all Remote AEs or separate for each Remote AE</b>	<b>Parameters</b>	<b>Default Value</b>	<b>Comments</b>
<b>Storage</b>				
System Parameters	All AEs	Institution Name	None	Populates the “Institution Name” attribute (0008,0080)
		Station Name	None	Populates the “Station Name” attribute (0008,1010)
Send Parameters	For each AE	Interpreting Physician	None	Populates the “Physician Reading Study” attribute (0008,1060) in all DICOM files
		Grayscale Only	No	Send images in color or grayscale
		Presentation Files	No	Send GSPS files (for IVA scans only)
		IVA Results Files	No	Send IVA Results files (for IVA scans only)
		Unicode	Yes	Encode strings using extended character set ISO IR 192
Storage Commitment Provider	For each AE	Use Storage Commitment	No	Request Storage Commitment for all sent DICOM files
		Select a Provider	None	Storage Commitment SCP
Enterprise Data Management	For each AE	Scan Archive Location	No	Include Apex scan data for subsequent Query Retrieve
		Select a Provider	None	Query Retrieve SCP
Automatic Retry Parameters	All AEs	Retry Number (times)	600	Number of times a failed job may be retried
		Retry Interval (Min)	20	Delay between retrying failed jobs

## APEX Software DICOM Conformance Statement

Category	For all Remote AEs or separate for each Remote AE	Parameters	Default Value	Comments
Log Management	All AEs	Purge Log Entries After N Days	10	Purge old entries from the log
Display	For each AE	Active	Yes	Display this SCP to the user among available SCPs
Data Fields	All AEs	Worklist Sets Modality	Yes	Use modality obtained from MWL or specified by the user
		Modality	OT	Modality to put into DICOM file (if modality from MWL is not used)
		Study Description	Blank	Study description to put into DICOM file (if study description from MWL is not used)
<b>Storage Commitment</b>				
Automatic Retry Parameters	All AEs	Retry Number (times)	3	Number of times a failed job may be retried
		Retry Interval (Min)	20	Delay between retrying failed jobs
Log Management	All AEs	Purge Log Entries After N Days	10	Purge old entries from the log
Mode	All AEs	Image-by-image or Batch	Batch	A separate Commit Request for each sent file or one Request for all files
Display	For each AE	Active	Yes	Display this SCP to the user among available SCPs
<b>Query Retrieve</b>				
Display	For each AE	Active	Yes	Display this SCP to the user among available SCPs

The table below describes parameters that can be configured by the user for Modality Worklist and Modality Performed Procedure Step activities. The user account has to have Windows Administrator rights to configure these parameters.

**Table 4.4-2.**

**User Configurable Parameters for Modality Worklist**

<b>Category</b>	<b>Parameters</b>	<b>Default Value</b>	<b>Comments</b>
<b>Modality Worklist</b>			
Query Parameters	<b>Default query</b>		
	Scheduled Station AE Title	None	Accessible via the System Configuration screen, used for automatic and default queries.
	Modality	None	
	Days Back	60	
	Days Forward	2	
	Maximum Hits Per Query	60	
	<b>Detailed query</b>		
	Patient ID	None	Accessible via the Worklist screen, used for user-interactive queries
	Patient Name	None	
	Accession Number	None	
Requested Procedure ID	None		
Detailed Query	Enable	Yes	Shows or hides the “Detailed Query” button on the Worklist screen
Automatic Query Interval	Every day at specified time	No	
	Every N hours	No	
	Never	Yes	
Automatic Retry Parameters	Query Timeout (min)	20	
	Retry Number	3	Number of times a failed job may be retried
	Retry Interval (min)	20	Delay between retrying failed jobs
	Patient Name	No	

## APEX Software DICOM Conformance Statement

Category	Parameters	Default Value	Comments
Patient Matching Parameters	Patient ID	Yes	Selected parameters are used for matching a selected Worklist entry with an Apex patient existing in local patient database
	Patient ID2	No	
	Patient Ethnicity	No	
	Patient DOB	Yes	
	Patient Sex	Yes	
Purge Interval	Used Entries (days)	100	Clean up entries, procedures for which have been performed
	Unused Entries (days)	100	Clean up entries, procedures for which have never been performed
Input from File	Enable	No	For EMR (Electronic Medical record) mode
	Input File	None	
MPPS	Enable	No	Enable creating MPPS Instances

The table below describes Apex fields that can be mapped to the Modality Worklist attributes. The user account has to have Windows Administrator rights to configure these parameters.

**Table 4.4-3.**

### Attribute Mapping for Modality Worklist

Apex Field	Worklist Attributes Available for Mapping	Default Selection
Patient Name	Patient Name (0010,0010)	Patient Name (0010,0010)
	Other Patient Names (0010,1001)	
	Patient Birth Name (0010,1005)	
	Patient Mother Birth Name (0010,1060)	
Patient ID	Patient ID (0010,0020)	Patient ID (0010,0020)
Patient ID2	Patient Name (0010,0010)	None
	Patient ID (0010,0020)	
	Other Patient IDs (0010,1000)	
Patient Ethnicity	Ethnic Group (0010,2160)	None
	Religious Preference (0010,21F0)	
Patient DOB	Patient Age (0010,1010)	Patient Birth Date (0010,0030)
	Patient Birth Date (0010,0030)	
Patient Sex	Patient Sex (0010,0040)	Patient Sex (0010,0040)



**APEX Software DICOM Conformance Statement**

<b>Apex Field</b>	<b>Worklist Attributes Available for Mapping</b>	<b>Default Selection</b>
Patient Weight	Patient Size (0010,1020)	Patient Weight (0010,1030)
	Patient Weight (0010,1030)	
Patient Height	Patient Size (0010,1020)	None
Referring Physician	Requesting Physician (0032,1032)	Referring Physician (0008,0090)
	Referring Physician (0008,0090)	
Procedure Code	Scheduled Procedure Step ID (0040,0009)	Scheduled Procedure Step ID (0040,0009)
	Requested Procedure ID (0040,1001)	
	Accession Number (0008,0050)	
	Admission ID (0038,0010)	
Study Name	Scheduled Procedure Step Description (0040,0007)	Scheduled Procedure Step Description (0040,0007)
	Scheduled Procedure Step ID (0040,0009)	
	Scheduled Action Item Code Sequence (0040,0008) / Code Value (0008,0100)	
	Requested Procedure Code Sequence (0032,1064) / Code Value (0008,0100)	
	Requested Procedure ID (0040,1001)	
	Accession Number (0008,0050)	
	Admission ID (0038,0010)	
Procedure Start Date	Scheduled Procedure Step Start Date (0040,0002)	Scheduled Procedure Step Start Date (0040,0002)
	Admitting Date (0038,0020)	
HL7 Field 1	All attributes	None
HL7 Field 2	All attributes	None
HL7 Field 3	All attributes	None
Unique Procedure Key	Accession Number (0008,0050)	Accession Number (0008,0050)
	Study Instance UID (0020,000D)	
Study Description	Scheduled Procedure Step Description (0040,0007)	None

The table below describes parameters that can be configured only by the Hologic Service Engineer.

**Table 4.4-2.**

**Service Engineer Configurable Parameters**

<b>Parameter</b>	<b>Were Used</b>
Maximum number of simultaneous incoming associations	Query Retrieve, Storage Commitment, Verification
Attributes used as Worklist Query Return Keys	Worklist
Attributes used for creating MPPS Instances	MPPS
Attributes available for mapping to Apex data fields	Worklist

## 5. Media Interchange

### 5.1. Implementation Model

#### 5.1.1. Application Data Flow

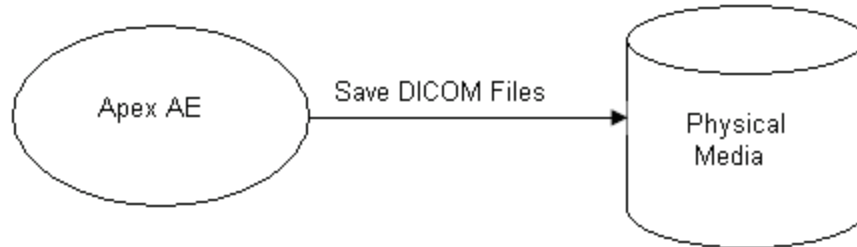

Figure 5.1-1. Application data Flow Diagram for Media Storage

The Apex AE saves DICOM files for selected scans to Physical Media.

#### 5.1.2. Functional Definition of AEs

The user saves Apex scans by selecting a scan and pressing “Save as...” button on the Apex DICOM Reports screen. The files are saved into a directory selected by the user.

#### 5.1.3. Sequencing of Real-World Activities

Only one Apex scan may be saved at a time.

#### 5.1.4. File Meta Information

The implementation information written to the File Meta Header in each file is:

Table 5.1-1.

#### DICOM Implementation Information

Implementation Class UID	1.2.840.113850
--------------------------	----------------

## 5.2. AE Specifications

The Apex Application Entity supports the SOP Classes and Transfer Syntaxes listed in the table below:

**Table 5.2-1.  
IODs, SOP Classes, and Transfer Syntaxes**

Secondary Capture Image Storage	1.2.840.10008.5.1.4.1.1.7	Implicit VR Little Endian	1.2.840.10008.1.2
---------------------------------	---------------------------	---------------------------	-------------------

## 6. Support of Character Sets

### 6.1. Reading Messages

When processing DICOM messages (received over the network or read from DICOM files), the Apex supports character sets as described below.

#### 6.1.1. Single Byte Character Sets without Code Extensions

Character Set Description	Defined Term
Default repertoire	None
Latin alphabet No 1	ISO IR 100
Latin alphabet No 2	ISO IR 101
Latin alphabet No 3	ISO IR 109
Latin alphabet No 4	ISO IR 110
Cyrillic	ISO IR 144
Arabic	ISO IR 127
Greek	ISO IR 126
Hebrew	ISO IR 138
Latin alphabet No 5	ISO IR 148
Japanese	ISO IR 13
Thai	ISO IR 166

#### 6.1.2. Multi-Byte Character Sets without Code Extensions

Character Set Description	Defined Term
Unicode in UTF-8	ISO IR 192
GB18030	GB18030

### 6.1.3. Single Byte Character Sets with Code Extensions

Character Set Description	Defined Term
Default repertoire	ISO 2022 IR 6
Latin alphabet No 1	ISO 2022 IR 100
Latin alphabet No 2	ISO 2022 IR 101
Latin alphabet No 3	ISO 2022 IR 109
Latin alphabet No 4	ISO 2022 IR 110
Cyrillic	ISO 2022 IR 144
Arabic	ISO 2022 IR 127
Greek	ISO 2022 IR 126
Hebrew	ISO 2022 IR 138
Latin alphabet No 5	ISO 2022 IR 148
Japanese	ISO 2022 IR 13
Thai	ISO 2022 IR 166

### 6.1.4. Multi-Byte Character Sets with Code Extensions

Character Set Description	Defined Term
Japanese (JIS X 0208: Kanji)	ISO 2022 IR 87
Japanese (JIS X 0212: Supplementary Kanji set)	ISO 2022 IR 159
Korean (KS X 1001: Hangul and Hanja)	ISO 2022 IR 149

## 6.2. Creating Messages

### 6.2.1. Modality Worklist Query

When creating a request message for Modality Worklist, the Apex supports character sets as described below.

#### 6.2.1.1. Single Byte Character Sets without Code Extensions

Character Set Description	Defined Term
Default repertoire	None
Latin alphabet No 1	ISO IR 100
Latin alphabet No 2	ISO IR 101
Latin alphabet No 3	ISO IR 109
Latin alphabet No 4	ISO IR 110

<b>Character Set Description</b>	<b>Defined Term</b>
Cyrillic	ISO IR 144
Arabic	ISO IR 127
Greek	ISO IR 126
Hebrew	ISO IR 138
Latin alphabet No 5	ISO IR 148
Japanese	ISO IR 13
Thai	ISO IR 166

**6.2.1.2. Multi-Byte Character Sets without Code Extensions**

<b>Character Set Description</b>	<b>Defined Term</b>
Unicode in UTF-8	ISO IR 192
GB18030	GB18030

**6.2.1.3. Single Byte Character Sets with Code Extensions**

<b>Character Set Description</b>	<b>Defined Term</b>
Default repertoire	ISO 2022 IR 6
Latin alphabet No 1	ISO 2022 IR 100
Latin alphabet No 2	ISO 2022 IR 101
Latin alphabet No 3	ISO 2022 IR 109
Latin alphabet No 4	ISO 2022 IR 110
Cyrillic	ISO 2022 IR 144
Arabic	ISO 2022 IR 127
Greek	ISO 2022 IR 126
Hebrew	ISO 2022 IR 138
Latin alphabet No 5	ISO 2022 IR 148
Japanese	ISO 2022 IR 13
Thai	ISO 2022 IR 166

**6.2.1.4. Multi-Byte Character Sets with Code Extensions**

<b>Character Set Description</b>	<b>Defined Term</b>
Japanese (JIS X 0208: Kanji)	ISO 2022 IR 87
Japanese (JIS X 0212: Supplementary Kanji set)	ISO 2022 IR 159
Korean (KS X 1001: Hangul and Hanja)	ISO 2022 IR 149

6.2.1.4.1. Other Message Types When creating DICOM messages other than for Modality Worklist query, the Apex supports following character sets:

<b>Character Set Description</b>	<b>Defined Term</b>
Default repertoire	None
Unicode in UTF-8	ISO_IR 192

## **7. Security**

Apex Modality does not support any specific security measures.

It is assumed that Apex Modality is used within a secured environment.



## 8. Annexes

### 8.1. IOD Contents

#### 8.1.1. Created SOP Instances

Tables below specify the attributes of Secondary Capture Image, Grayscale Softcopy Presentation State, and Enhanced SR instances transmitted by the Apex application.

The tables use a number of abbreviations.

The abbreviations used in the “Presence of ...” column are:

VNAP        Value Not Always Present (attribute sent zero length if no value is present)

ANAP        Attribute Not Always Present

ALWAYS     Always Present

EMPTY      Attribute is sent without a value

The abbreviations used in the “Source” column:

MWL        The attribute value source is from Modality Worklist

USER        The attribute value source is from User input

AUTO        The attribute value is generated automatically

MPPS        The attribute value is the same as that use for Modality Performed Procedure Step

CONFIG     The attribute value source is a configurable parameter

Note: All dates and times are encoded in the local configured calendar and time.

##### 8.1.1.1. Secondary Capture Image

**Table 8.1-1.**

**IOD of Created SC SOP Instances for Apex Scan Images**

Attribute Name	Tag	VR	Value	Presence of Value	Source
<b>Patient Module</b>					
Patient’s Name	(0010,0010)	PN	Note 1	VNAP	MWL/USER
Patient ID	(0010,0020)	LO	Note 2	VNAP	MWL/USER
Patient’s Birth Date	(0010,0030)	DA	Note 3	VNAP	MWL/USER
Patient’s Sex	(0010,0040)	CS	Note 4	VNAP	MWL/USER

**APEX Software DICOM Conformance Statement**

<b>Attribute Name</b>	<b>Tag</b>	<b>VR</b>	<b>Value</b>	<b>Presence of Value</b>	<b>Source</b>
Other Patient IDs	(0010,1000)	LO	From Worklist	VNAP	MWL
<b>General Study Module</b>					
Study Instance UID	(0020,000D)	UI	Note 5	ALWAYS	MWL/AUTO/USER
Study Date	(0008,0020)	DA	<yyyymmdd>	ALWAYS	AUTO
Study Time	(0008,0030)	TM	<hhmmss>	ALWAYS	AUTO
Referring Physician's Name	(0008,0090)	PN	Note 6	VNAP	MWL/USER
Study ID	(0020,0010)	SH	Same as Accession Number	VNAP	AUTO
Accession Number	(0008,0050)	SH	Note 7	VNAP	MWL/AUTO/USER
Study Description	(0008,1030)	LO	Note 15	ANAP	MWL/CONFIG
Physician Reading Study	(0008,1060)	PN	Note 8	VNAP	USER
<b>General Series Module</b>					
Modality	(0008,0060)	CS	Note 9	ALWAYS	MWL/CONFIG
Series Instance UID	(0020,000E)	UI	Generated by Apex	ALWAYS	AUTO
Series Number	(0020,0011)	IS	Generated by Apex	ALWAYS	AUTO
Laterality	(0020,0060)	CS	Note 10	ANAP	AUTO
Body Part Examined	(0018,0015)	CS	Note 11	VNAP	AUTO
Request Attribute Sequence	(0040,0275)	SQ	Note 12	ANAP	MWL
>Requested Procedure ID	(0040,1001)	SH	Note 12	ANAP	MWL
>Scheduled Procedure Step Description	(0040,0007)	LO	Note 12	ANAP	MWL

**APEX Software DICOM Conformance Statement**

<b>Attribute Name</b>	<b>Tag</b>	<b>VR</b>	<b>Value</b>	<b>Presence of Value</b>	<b>Source</b>
>Scheduled Procedure Step ID	(0040,0009)	SH	Note 12	ANAP	MWL
Referenced Study Component Sequence	(0008,1111)	SQ	Included if MPPS SOP Instance was created for this scan	ANAP	MPPS
>Referenced SOP Class UID	(0008,1150)	UI	MPPS SOP Class UID	ANAP	MPPS
>Referenced SOP Instance UID	(0008,1155)	UI	Generated by Apex	ANAP	MPPS
Protocol Name	(0018,1030)	LO	Zero length	EMPTY	AUTO
PPS Start Date	(0040,0244)	DA	Same as Study Date	VNAP	MPPS
PPS Start Time	(0040,0245)	TM	Same as Study Time	VNAP	MPPS
PPS ID	(0040,0253)	SH	Generated by Apex	VNAP	MPPS
PPS Description	(0040,0254)	LO	Zero length	VNAP/ EMPTY	MPPS
<b>General Equipment Module</b>					
Manufacturer	(0008,0070)	LO	HOLOGIC	ALWAYS	AUTO
Institution Name	(0008,0080)	LO	From Configuration	ALWAYS	CONFIG
Station Name	(0008,1010)	SH	From Configuration	ALWAYS	CONFIG
Manfr's Model Name	(0008,1090)	LO	From Configuration	ALWAYS	CONFIG
Device S/N	(0018,1000)	LO	From Configuration	ALWAYS	CONFIG
S/W Versions	(0018,1020)	LO	From Configuration	ALWAYS	CONFIG
<b>SC Equipment Module</b>					
Conversion Type	(0008,0064)	CS	DV	ALWAYS	AUTO

## APEX Software DICOM Conformance Statement

Attribute Name	Tag	VR	Value	Presence of Value	Source
SC Device Software Version	(0018,1019)	LO	From Configuration	ALWAYS	CONFIG
<b>General Image Module</b>					
Image Number	(0020,0013)	IS	Generated by Apex	ALWAYS	AUTO
Patient Orientation	(0020,0020)	CS	L\F	ALWAYS	AUTO
Image Comments	(0020,4000)	LT	Note 13	EMPTY	AUTO
<b>Image Pixel Module</b>					
Samples per pixel	(0028,0002)	US	1 for grayscale, 3 for color images	ALWAYS	AUTO
Photometric Interpretation	(0028,0004)	CS	MONOCHROME2 for grayscale, RGB for color images	ALWAYS	AUTO
Planar Configuration	(0028,0006)	US	Not included for grayscale, 0 for color images	ANAP	AUTO
Rows	(0028,0010)	US	Generated by Apex	ALWAYS	AUTO
Columns	(0028,0011)	US	Generated by Apex	ALWAYS	AUTO
Pixel Spacing	(0028,0030)	US	Generated by Apex, used only for IVA scans	VNAP	AUTO
Bits Allocated	(0028,0100)	US	Note 14	ALWAYS	AUTO
Bits Stored	(0028,0101)	US	Note 14	ALWAYS	AUTO
High Bit	(0028,0102)	US	Note 14	ALWAYS	AUTO
Pixel Representation	(0028,0103)	US	0	ALWAYS	AUTO
<b>SC Image Module</b>					
Date of Secondary Capture	(0018,1012)	DA	<yyyymmdd>, date of this DICOM file creation	ALWAYS	AUTO
Time of Secondary Capture	(0018,1014)	TM	<hhmmss>, time of this DICOM file creation	ALWAYS	AUTO

## APEX Software DICOM Conformance Statement

Attribute Name	Tag	VR	Value	Presence of Value	Source
<b>VOI LUT Module</b>					
Window Center	(0028,1050)	DS	Generated by Apex	ALWAYS	AUTO
Window Width	(0028,1051)	DS	Generated by Apex	ALWAYS	AUTO
<b>SOP Common Module</b>					
Specific Character Set	(0008,0005)	CS	ISO_IR 192, included only if configured to use Unicode	ANAP	CONFIG
SOP Class UID	(0008,0016)	UI	Secondary Capture Image Storage SOP Class UID	ALWAYS	AUTO
SOP Instance UID	(0008,0018)	UI	Generated by Apex	ALWAYS	AUTO
<b>X-Ray Acquisition Module</b>					
Image Dose Area Product	(0018,115E)	DS	Note 16	ANAP	AUTO
<b>Image Pixel Module</b>					
Pixel Data	(7FE0,0010)	OW	Generated by Apex	ALWAYS	AUTO
<b>Private Patient Questionnaire Module</b> (Included only in DICOM files containing questionnaire reports)					
Private Creator	(0011,0010)	LO	HOLOGIC	ANAP	AUTO
Questionnaire Data	(0011,1000)	OB	Generated by Apex	ANAP	AUTO
<b>Private Report Data Module</b> (Included only in DICOM files containing scans)					
Private Creator	(0019,0010)	LO	HOLOGIC	VNAP	AUTO
Report Data	(0019,1000)	UT	Generated by Apex	VNAP	AUTO
<b>Private Scan Files Data Module</b> (Included only when sent to archive locations)					
Private Creator	(0023,0010)	LO	HOLOGIC	VNAP	AUTO

## APEX Software DICOM Conformance Statement

Attribute Name	Tag	VR	Value	Presence of Value	Source
Encoding Scheme	(0023,1000)	LO	1.0	VNAP	AUTO
P File Name	(0023,1001)	LO	Generated by Apex	VNAP	AUTO
P File Data	(0023,1002)	OB	Generated by Apex	VNAP	AUTO
P File Length	(0023,1003)	UL	Generated by Apex	VNAP	AUTO
R File Data	(0023,1004)	OB	Generated by Apex	VNAP	AUTO
R File Length	(0023,1005)	UL	Generated by Apex	VNAP	AUTO
<b>Private Graph Data Module</b> (Included only for reports containing graphs)					
Private Creator	(0029,0010)	LO	HOLOGIC	ANAP	AUTO
Graph Bitmap Data	(0029,1000)	OB	Generated by Apex	ANAP	AUTO
Graph Bitmap Size	(0029,1001)	UL	Generated by Apex	ANAP	AUTO

Notes:

1. Values supplied via Modality Worklist will be entered as received. Values supplied via user input will contain 3 components (some possibly empty): last name (maximum 64 characters), first name (maximum 25 characters), and middle name (maximum 8 characters).
2. Value supplied via Modality Worklist will be entered as received. Value supplied via user input is maximum 64 characters and may be blank.
3. Value supplied via Modality Worklist will be entered as received. Value supplied via user input may be blank.
4. Value supplied via Modality Worklist will be entered as received. Value supplied via user input will always be M or F.
5. Value supplied via Modality Worklist will be entered as received. Otherwise the value will be generated by Apex. The administrative user can modify the value via Scan Details screen.
6. Value supplied via Modality Worklist will be entered as received. Value supplied via user input is a single value not divided by components, is maximum 25 characters, and may be blank.

7. Value supplied via Modality Worklist will be entered as received. For non-Worklist studies, the system may be configured to generate the value automatically, using format SSSSSSYMMDDNNN, where SSSSSS is the Apex serial number, YYMMDD is the current date, and NNN is the exam index. In either case, the value is editable by the user, accepts maximum 16 characters, and may be blank.
8. Value is supplied via user input, is a single value not divided by components, is maximum 120 characters, and may be blank.
9. Based on the configuration, uses value obtained from MWL or configured by the user.
10. Populated only for paired structures. Values are: R = right, L = left.
11. Body Part Values: LSPINE, HIP, ARM. For scan types not described by these values, the attribute is zero length.
12. Included only if supplied by Modality Worklist and if Requested Procedure ID attribute (0040,1001) is not blank.
13. Formerly contained text incorporating analysis results. Starting from Apex 2.0, private group 0019 is used for this data, and this attribute always has zero length.
14. For Single Energy IVA Images: Bits Allocated = 16, Bits Stored = 12, High Bit = 11; for all other images: Bits Allocated = 8, Bits Stored = 8, High Bit = 7.
15. If mapped to a MWL attribute, the field is always included, with value of the mapped attribute. If not mapped or for non-MWL studies, the field uses value configured by the user, or not included if the user specified blank value.
16. The attribute is present only if all conditions below are met:
  - a. The DAP Meter option is installed
  - b. The system is configured to report DAP
  - c. The scan has a stored DAP value.

**Table 8.1-2.**

**IOD of Created SC SOP Instances for Apex IVA Results Images**

<b>Attribute Name</b>	<b>Tag</b>	<b>VR</b>	<b>Value</b>	<b>Presence of Value</b>	<b>Source</b>
<b>Patient Module</b>					
Patient's Name	(0010,0010)	PN	From source scan image	VNAP	MWL/USER
Patient ID	(0010,0020)	LO	From source scan image	VNAP	MWL/USER
Patient's Birth Date	(0010,0030)	DA	From source scan image	VNAP	MWL/USER
Patient's Sex	(0010,0040)	CS	From source scan image	VNAP	MWL/USER
<b>General Study Module</b>					
Study Instance UID	(0020,000D)	UI	From source scan image	ALWAYS	MWL/AUTO/USER
Study Date	(0008,0020)	DA	From source scan image	ALWAYS	AUTO
Study Time	(0008,0030)	TM	From source scan image	ALWAYS	AUTO
Referring Physician's Name	(0008,0090)	PN	From source scan image	VNAP	MWL/USER
Study ID	(0020,0010)	SH	From source scan image	VNAP	AUTO
Accession Number	(0008,0050)	SH	From source scan image	VNAP	MWL/USER
<b>General Series Module</b>					
Modality	(0008,0060)	CS	From source scan image	ALWAYS	CONFIG
Series Instance UID	(0020,000E)	UI	From source scan image	ALWAYS	AUTO
Series Number	(0020,0011)	IS	Generated by Apex	ALWAYS	AUTO
<b>General Equipment Module</b>					
Manufacturer	(0008,0070)	LO	HOLOGIC	ALWAYS	AUTO
Institution Name	(0008,0080)	LO	From Configuration	ALWAYS	CONFIG



## APEX Software DICOM Conformance Statement

Attribute Name	Tag	VR	Value	Presence of Value	Source
Manfr's Model Name	(0008,1090)	LO	From Configuration	ALWAYS	CONFIG
Device S/N	(0018,1000)	LO	From Configuration	ALWAYS	CONFIG
S/W Versions	(0018,1020)	LO	From Configuration	ALWAYS	CONFIG
<b>SC Equipment Module</b>					
Conversion Type	(0008,0064)	CS	DV	ALWAYS	AUTO
SC Device Software Version	(0018,1019)	LO	From Configuration	ALWAYS	CONFIG
<b>General Image Module</b>					
Image Number	(0020,0013)	IS	Generated by Apex	ALWAYS	AUTO
<b>Image Pixel Module</b>					
Samples per pixel	(0028,0002)	US	1	ALWAYS	AUTO
Photometric Interpretation	(0028,0004)	CS	MONOCHROME2	ALWAYS	AUTO
Rows	(0028,0010)	US	Generated by Apex	ALWAYS	AUTO
Columns	(0028,0011)	US	Generated by Apex	ALWAYS	AUTO
Bits Allocated	(0028,0100)	US	8	ALWAYS	AUTO
Bits Stored	(0028,0101)	US	8	ALWAYS	AUTO
High Bit	(0028,0102)	US	7	ALWAYS	AUTO
Pixel Representation	(0028,0103)	US	0	ALWAYS	AUTO
<b>SC Image Module</b>					
Date of Secondary Capture	(0018,1012)	DA	<yyyymmdd>, date of this DICOM file creation	ALWAYS	AUTO
Time of Secondary Capture	(0018,1014)	TM	<hhmmss>, time of this DICOM file creation	ALWAYS	AUTO

## APEX Software DICOM Conformance Statement

Attribute Name	Tag	VR	Value	Presence of Value	Source
<b>SOP Common Module</b>					
Specific Character Set	(0008,0005)	CS	ISO_IR 192, included only if configured to use Unicode	ANAP	CONFIG
SOP Class UID	(0008,0016)	UI	Secondary Capture Image Storage SOP Class UID	ALWAYS	AUTO
SOP Instance UID	(0008,0018)	UI	Generated by Apex	ALWAYS	AUTO
<b>Image Pixel Module</b>					
Pixel Data	(7FE0,0010)	OW	Generated by Apex	ALWAYS	AUTO
<b>Private Flags Module</b>					
Private Creator	(0013,0010)	LO	HOLOGIC	ALWAYS	AUTO
IVA Results Flag	(0013,1000)	LO	IVA Results	ALWAYS	AUTO

### 8.1.1.2. Grayscale Softcopy Presentation State

Table 8.1-3.

**IOD of Created GSPS SOP Instances for Apex IVA Analysis Results**

Attribute Name	Tag	VR	Value	Presence of Value	Source
<b>Patient Module</b>					
Patient's Name	(0010,0010)	PN	From referenced image	VNAP	MWL/USER
Patient ID	(0010,0020)	LO	From referenced image	VNAP	MWL/USER
Patient's Birth Date	(0010,0030)	DA	From referenced image	VNAP	MWL/USER
Patient's Sex	(0010,0040)	CS	From referenced image	VNAP	MWL/USER
<b>General Study Module</b>					
Study Instance UID	(0020,000D)	UI	From referenced image	ALWAYS	MWL/AUTO/USER

**APEX Software DICOM Conformance Statement**

<b>Attribute Name</b>	<b>Tag</b>	<b>VR</b>	<b>Value</b>	<b>Presence of Value</b>	<b>Source</b>
Study Date	(0008,0020)	DA	From referenced image	ALWAYS	AUTO
Study Time	(0008,0030)	TM	From referenced image	ALWAYS	AUTO
Referring Physician's Name	(0008,0090)	PN	From referenced image	VNAP	MWL/USER
Study ID	(0020,0010)	SH	From referenced image	VNAP	AUTO
Accession Number	(0008,0050)	SH	From referenced image	VNAP	MWL/USER
<b>General Series Module</b>					
Series Instance UID	(0020,000E)	UI	Generated by Apex	ALWAYS	AUTO
Series Number	(0020,0011)	IS	Generated by Apex	ALWAYS	AUTO
Laterality	(0020,0060)	CS	From referenced image	ANAP	AUTO
<b>Presentation Series Module</b>					
Modality	(0008,0060)	CS	PR	ALWAYS	CONFIG
<b>General Equipment Module</b>					
Manufacturer	(0008,0070)	LO	HOLOGIC	ALWAYS	AUTO
S/W Versions	(0018,1020)	LO	From Configuration	ALWAYS	CONFIG
<b>Presentation State Module</b>					
Image Number	(0020,0013)	IS	Generated by Apex	ALWAYS	AUTO
Presentation Label	(0070,0080)	CS	HOLOGIC	ALWAYS	AUTO
Presentation Description	(0070,0081)	LO	Hologic QDR IVA Analysis	ALWAYS	AUTO
Presentation Creation Date	(0070,0082)	DA	<yyyymmdd>, date of this GSPS file creation	ALWAYS	AUTO
Presentation Creation Time	(0070,0083)	TM	<hhmmss>, time of this GSPS file creation	ALWAYS	AUTO

**APEX Software DICOM Conformance Statement**

<b>Attribute Name</b>	<b>Tag</b>	<b>VR</b>	<b>Value</b>	<b>Presence of Value</b>	<b>Source</b>
Presentation Creator's Name	(0070,0084)	PN	Zero length	EMPTY	AUTO
Referenced Series Sequence	(0008,1115)	SQ	One item	ALWAYS	AUTO
>Series Instance UID	(0020,000E)	UI	From referenced image	ALWAYS	AUTO
>Referenced Image Sequence	(0008,1140)	SQ	One item	ALWAYS	AUTO
>>Referenced SOP Class UID	(0008,1150)	UI	From referenced image	ALWAYS	AUTO
>>Referenced SOP Instance UID	(0008,1155)	UI	From referenced image	ALWAYS	AUTO
<b>Displayed Area Module</b>					
Displayed Area Selection Sequence	(0070,005A)	SQ	One item	ALWAYS	AUTO
>Displayed Area Top Left Hand Corner	(0070,0052)	SL	0\0	ALWAYS	AUTO
>Displayed Area Bottom Right Hand Corner	(0070,0053)	SL	Referenced Image Width\Height	ALWAYS	AUTO
>Presentation Size Mode	(0070,0100)	SL	SCALE TO FIT	ALWAYS	AUTO
>Presentation Pixel Aspect Ratio	(0070,0102)	IS	1\1	ALWAYS	AUTO
<b>Graphic Annotation Module</b>					
Graphic Annotation Sequence	(0070,0001)	SQ	One or more items	ALWAYS	AUTO
>Graphic Layer	(0070,0002)	CS	1	ALWAYS	AUTO

**APEX Software DICOM Conformance Statement**

<b>Attribute Name</b>	<b>Tag</b>	<b>VR</b>	<b>Value</b>	<b>Presence of Value</b>	<b>Source</b>
>Text Object Sequence	(0070,0008)	SQ	One or more items if text annotation present	ANAP	AUTO
>>Anchor Point Annotation Units	(0070,0004)	CS	PIXEL	ANAP	AUTO
>>Unformatted Text Value	(0070,0006)	ST	From user input	ANAP	AUTO
>>Bounding Box Top Left Hand Corner	(0070,0010)	FL	From user input	ANAP	AUTO
>>Bounding Box Bottom Right Hand Corner	(0070,0011)	FL	From user input	ANAP	AUTO
>>Bounding Box Text Horizontal Justification	(0070,0012)	CS	LEFT	ANAP	AUTO
>Graphic Object Sequence	(0070,0009)	SQ	One or more items if graphic annotation present	ANAP	AUTO
>>Graphic Annotation Units	(0070,0005)	CS	PIXEL	ANAP	AUTO
>>Graphic Dimensions	(0070,0020)	US	From user input	ANAP	AUTO
>>Number of Graphic Points	(0070,0021)	US	From user input	ANAP	AUTO
>>Graphic Data	(0070,0022)	FL	From user input	ANAP	AUTO
>>Graphic Type	(0070,0023)	CS	POLYLINE	ANAP	AUTO
>>Graphic Filled	(0070,0024)	CS	N	ANAP	AUTO

## APEX Software DICOM Conformance Statement

Attribute Name	Tag	VR	Value	Presence of Value	Source
<b>Graphic Layer Module</b>					
Graphic Layer Sequence	(0070,0060)	SQ	One item	ALWAYS	AUTO
>Graphic Layer	(0070,0002)	CS	1	ALWAYS	AUTO
>Graphic Layer Order	(0070,0062)	IS	1	ALWAYS	AUTO
<b>Presentation LUT Module</b>					
Presentation LUT Shape	(2050,0020)	CS	IDENTITY	ALWAYS	AUTO
<b>SOP Common Module</b>					
Specific Character Set	(0008,0005)	CS	ISO_IR 192, included only if configured to use Unicode	ANAP	CONFIG
SOP Class UID	(0008,0016)	UI	GSPS SOP Class UID	ALWAYS	AUTO
SOP Instance UID	(0008,0018)	UI	Generated by Apex	ALWAYS	AUTO

### 8.1.1.3. Enhanced Structured Reporting

**Table 8.1-4**  
**IOD of Created Enhanced SR SOP Instances**

Attribute Name	Tag	VR	Value	Presence of Value	Source
<b>Patient Module</b>					
Patient's Name	(0010,0010)	PN	See matching field in table 8.1-1	VNAP	MWL/USER
Patient ID	(0010,0020)	LO	See matching field in table 8.1-1	VNAP	MWL/USER
Patient's Birth Date	(0010,0030)	DA	See matching field in table 8.1-1	VNAP	MWL/USER
Patient's Sex	(0010,0040)	CS	See matching field in table 8.1-1	VNAP	MWL/USER

## APEX Software DICOM Conformance Statement

Attribute Name	Tag	VR	Value	Presence of Value	Source
<b>General Study Module</b>					
Study Instance UID	(0020,000D)	UI	See matching field in table 8.1-1	ALWAYS	MWL/AUTO / USER
Study Date	(0008,0020)	DA	See matching field in table 8.1-1	ALWAYS	AUTO
Study Time	(0008,0030)	TM	See matching field in table 8.1-1	ALWAYS	AUTO
Referring Physician's Name	(0008,0090)	PN	See matching field in table 8.1-1	VNAP	MWL/USER
Study ID	(0020,0010)	SH	See matching field in table 8.1-1	VNAP	AUTO
Accession Number	(0008,0050)	SH	See matching field in table 8.1-1	VNAP	MWL/USER
<b>SR Document Series</b>					
Modality	(0008,0060)	CS	SR	ALWAYS	CONFIG
Series Instance UID	(0020,000E)	UI	See matching field in table 8.1-1	ALWAYS	AUTO
Series Number	(0020,0011)	IS	Generated by Apex	ALWAYS	AUTO
Referenced Performed Procedure Step Sequence	0008,1111	SQ	NULL	EMPTY	AUTO
<b>General Equipment Module</b>					
Manufacturer	(0008,0070)	LO	HOLOGIC	ALWAYS	AUTO
Institution Name	(0008,0080)	LO	From Configuration	ALWAYS	CONFIG
Manfr's Model Name	(0008,1090)	LO	From Configuration	ALWAYS	CONFIG
Device S/N	(0018,1000)	LO	From Configuration	ALWAYS	CONFIG
S/W Versions	(0018,1020)	LO	From Configuration	ALWAYS	CONFIG

## APEX Software DICOM Conformance Statement

Attribute Name	Tag	VR	Value	Presence of Value	Source
<b>SR Document General Module</b>					
Instance Number	(0020,0013)	IS	Generated by Apex	ALWAYS	AUTO
Completion Flag	(0040,A491)	CS	COMPLETED	ALWAYS	AUTO
Verification Flag	(0040,A493)	CS	UNVERIFIED	ALWAYS	AUTO
Content Date	(0008,0023)	DA	Scan Analysis Date	ALWAYS	AUTO
Content Time	(0008,0033)	TM	Scan Analysis Time	ALWAYS	AUTO
Performed Procedure Code Sequence	(0040,A372)	SQ	NULL	EMPTY	AUTO
<b>SR Document Content Module</b>					
Value Type	(0040,A040)	CS	CONTAINER	ALWAYS	AUTO
Concept Name Code Sequence	(0040,A043)	SQ	One Item containing (2-0-01, 99HOLXDXA, "Hologic DXA Structured Report")	ALWAYS	AUTO
Continuity of Content	(0040,A050)	CS	SEPARATE	ALWAYS	AUTO
Content Sequence	(0040,A730)	SQ	Sequence contains multiple Items according to Private TID 6000	ALWAYS	AUTO
<b>SOP Common Module</b>					
Specific Character Set	(0008,0005)	CS	ISO_IR 192, included only if configured to use Unicode	ANAP	CONFIG
SOP Class UID	(0008,0016)	UI	Enhanced SR Storage SOP Class UID	ALWAYS	AUTO
SOP Instance UID	(0008,0018)	UI	Generated by Apex	ALWAYS	AUTO



**8.1.2. Usage of Attributes from Received IODs**

**Table 8.1-4.  
Used Attributes in Received IODs**

<b>Attribute Name</b>	<b>Tag</b>	<b>VR</b>
Manufacturer	(0008,0070)	LO
Study Instance UID	(0020,000D)	UI
Series Instance UID	(0020,000E)	UI
Date of Secondary Capture	(0018,1012)	DA
Time of Secondary Capture	(0018,1014)	TM
P File Name	(0023,1001)	LO
P File Data	(0023,1002)	OB
P File Length	(0023,1003)	UL
R File Data	(0023,1004)	OB
R File Length	(0023,1005)	UL

**8.1.3. Attribute Mapping**

The relationships between attributes received via Modality Worklist, stored in acquired images and communicated via MPPS are summarized in the table below. The format and conventions used in the table are the same as the corresponding table in DICOM Part 4, Annex M.6.

**Table 8.1-5.  
Attribute Mapping between Modality Worklist, Image, and MPPS**

<b>Modality Worklist</b>	<b>Image IOD</b>	<b>MPPS IOD</b>
Patient Name*	Patient Name	Patient Name
Patient ID*	Patient ID	Patient ID
Patient DOB*	Patient DOB	Patient DOB
Patient Sex	Patient Sex	Patient Sex
Referring Physician Name*	Referring Physician Name	
		Scheduled Step Attribute Sequence

## APEX Software DICOM Conformance Statement

<b>Modality Worklist</b>	<b>Image IOD</b>	<b>MPPS IOD</b>
Study Instance UID	Study Instance UID	>Study Instance UID
Referenced Study Sequence		> Referenced Study Sequence
Accession Number	Accession Number	>Accession Number
Placer Order Number		> Placer Order Number
Filler Order Number		> Filler Order Number
	Request Attribute Sequence	
Requested Procedure ID	> Requested Procedure ID	> Requested Procedure ID
Requested Procedure Description		> Requested Procedure Description
Scheduled Procedure Step ID	> Scheduled Procedure Step ID	> Scheduled Procedure Step ID
Scheduled Procedure Step Description	> Scheduled Procedure Step Description	> Scheduled Procedure Step Description
Scheduled Protocol Code Sequence		> Scheduled Protocol Code Sequence
Scheduled Station AE Title	AE Title	Performed Station AE Title
	Study Date	Performed Procedure Step Start Date
	Study Time	Performed Procedure Step Start Time
Scheduled Procedure Step ID*	Procedure Code	Performed Procedure Step ID
Modality	Modality	Modality
Other Patient Ids	Other Patient Ids	
Study Description*	Study Description	
		Performed Series Sequence
	Series Instance UID	>Series Instance UID

\* This Apex field may be mapped to a different Worklist attribute or not mapped at all. In this case value of that attribute will be used, or the value will no be used at all.

**8.1.4. Coerced/Modified Fields**

**Table 8.1-6.**

**Attributes that may be coerced**

<b>Attribute</b>	<b>Coercion Condition</b>
Patient Name	<ol style="list-style-type: none"> <li>1. User action</li> <li>2. Automatic truncation if obtained from Worklist and exceeds length used by Apex: First name – 25 characters, and middle name – 8 characters</li> </ol>
Patient ID	User action
Patient Ethnicity	User action
Patient Date of Birth	User action
Patient Sex	User action
Referring Physician	<ol style="list-style-type: none"> <li>1. User action</li> <li>2. Automatic truncation if obtained from Worklist and exceeds length used by Apex: 25 characters combined for all components</li> </ol>
Accession Number	User action
Study Instance UID	User action

**8.2. Data Dictionary of Private Attributes**

**Table 8.2-1.**

**Dictionary of Private Attributes used by Apex**

<b>Tag</b>	<b>Attribute Name</b>	<b>VR</b>	<b>VM</b>
<b>Private Patient Questionnaire Group</b>			
(0011,0010)	Private Creator	LO	1
(0011,1000)	Questionnaire Data	OB	1
<b>Private Report Data Group</b>			
(0019,0010)	Private Creator	LO	1
(0019,1000)	Report Data	UT	1
<b>Private Scan Files Data Group</b>			
(0023,0010)	Private Creator	LO	1
(0023,1000)	Encoding Scheme	LO	1

<b>Tag</b>	<b>Attribute Name</b>	<b>VR</b>	<b>VM</b>
(0023,1001)	P File Name	LO	1
(0023,1002)	P File Data	OB	1
(0023,1003)	P File Length	UL	1
(0023,1004)	R File Data	OB	1
(0023,1005)	R File Length	UL	1
<b>Private Graph Data Group</b>			
(0029,0010)	Private Creator	LO	1
(0029,1000)	Graph Bitmap Data	OB	1
(0029,1001)	Graph Bitmap Size	UL	1
<b>Private Flags Group</b>			
(0013,0010)	Private Creator	LO	1
(0013,1000)	IVA Results Flag	LO	1

### 8.3. Coded Terminology and Templates

The Apex AE is capable of supporting arbitrary coding schemes. The contents of Code Sequences supplied in Worklist items can be mapped to Image IOD and MPPS attributes.

#### 8.3.1. Context Groups

In the tables below, the Code Meanings are provided in English, but when creating a SR object they are translated into the selected language of the application.

**Table 8.3.1-1**

**Private Context Group – Report Types**

<b>Coding Scheme Designator (0008,0102)</b>	<b>Code Value (0008,0100)</b>	<b>Code Meaning (0008,0104)</b>
99HOLXDXA	1-1-01	BMD Report
99HOLXDXA	1-1-02	Extended AP Lumbar Spine Report
99HOLXDXA	1-1-03	Combined AP/Lateral Report
99HOLXDXA	1-1-04	Standardized BMD Report
99HOLXDXA	1-1-05	Extended AP Lumbar Spine with Standardized BMD Report
99HOLXDXA	1-1-06	Clinical Body Composition (BCA) Report
99HOLXDXA	1-1-07	Body Composition with BMD Report
99HOLXDXA	1-1-08	Hip Structure Analysis Report

**APEX Software DICOM Conformance Statement**

<b>Coding Scheme Designator (0008,0102)</b>	<b>Code Value (0008,0100)</b>	<b>Code Meaning (0008,0104)</b>
99HOLXDXA	1-1-09	Dual Hip Report
99HOLXDXA	1-1-10	Extended Dual Hip Report
99HOLXDXA	1-2-01	BMD Rate of Change Report
99HOLXDXA	1-2-02	Extended Hip Rate of Change Report
99HOLXDXA	1-2-03	Body Composition with BMD Rate of Change Report
99HOLXDXA	1-2-04	Body Composition (BCA) Rate of Change Report
99HOLXDXA	1-2-05	Dual Hip Rate of Change Report
99HOLXDXA	1-3-01	IVA Report
99HOLXDXA	1-3-02	SE Femur Report
99HOLXDXA	1-4-01	Pediatric Whole Body Report
99HOLXDXA	1-4-02	Pediatric Spine Report
99HOLXDXA	1-4-03	Pediatric Hip Report

**Table 8.3.1-2**

**Private Context Group – Report Data**

<b>Coding Scheme Designator (0008,0102)</b>	<b>Code Value (0008,0100)</b>	<b>Code Meaning (0008,0104)</b>
99HOLXDXA	2-0-01	Hologic DXA Structured Report
<b>Scan Information</b>		
99HOLXDXA	2-1-00	Scan Information
99HOLXDXA	2-1-01	Scan ID
99HOLXDXA	2-1-02	Scan Date
99HOLXDXA	2-1-03	Scan Type
99HOLXDXA	2-1-04	Analysis Date Time
99HOLXDXA	2-1-05	Analysis Version
99HOLXDXA	2-1-06	Analysis Type
99HOLXDXA	2-1-07	Operator
99HOLXDXA	2-1-08	Model
99HOLXDXA	2-1-09	Serial Number
99HOLXDXA	2-1-10	Scan Comment
99HOLXDXA	2-1-11	Reference Curve Source

**APEX Software DICOM Conformance Statement**

<b>Coding Scheme Designator (0008,0102)</b>	<b>Code Value (0008,0100)</b>	<b>Code Meaning (0008,0104)</b>
<b>Analysis Results Set Names</b>		
99HOLXDXA	2-2-00	Results Set Title
99HOLXDXA	2-2-01	Results Set 1
99HOLXDXA	2-2-02	Results Set 2
99HOLXDXA	2-2-03	Results Set 3
99HOLXDXA	2-2-04	Results Set 4
99HOLXDXA	2-2-05	Results Set 5
99HOLXDXA	2-2-06	Results Set 6
99HOLXDXA	2-2-07	Results Set 7
99HOLXDXA	2-2-08	Results Set 8
99HOLXDXA	2-2-09	Results Set 9
99HOLXDXA	2-2-10	Results Set 10
<b>Scan Data</b>		
99HOLXDXA	2-3-01	DAP
99HOLXDXA	2-3-02	ACF
99HOLXDXA	2-3-03	BCF
<b>Patient Data</b>		
99HOLXDXA	2-4-01	Patient Height
99HOLXDXA	2-4-02	Patient Weight
99HOLXDXA	2-4-03	Ethnicity
99HOLXDXA	2-4-04	Menopause Age
99HOLXDXA	2-4-05	Adjusted Age

**Table 8.3.2-3  
Private Context Group – Results and Measures Names**

<b>Coding Scheme Designator (0008,0102)</b>	<b>Code Value (0008,0100)</b>	<b>Code Meaning (0008,0104)</b>
<b>Result Types</b>		
99HOLXDXA	3-1-01	Region
99HOLXDXA	3-1-02	Area
99HOLXDXA	3-1-03	BMC
99HOLXDXA	3-1-04	BMD
99HOLXDXA	3-1-05	T-Score

## APEX Software DICOM Conformance Statement

Coding Scheme Designator (0008,0102)	Code Value (0008,0100)	Code Meaning (0008,0104)
99HOLXDXA	3-1-06	Z-Score
99HOLXDXA	3-1-07	Peak Reference
99HOLXDXA	3-1-08	Age Matched
99HOLXDXA	3-2-01	Standardized BMD
99HOLXDXA	3-2-02	WA-BMD
99HOLXDXA	3-3-01	Sub Peri. Width
99HOLXDXA	3-3-02	Endo Cort. Width
99HOLXDXA	3-3-03	CSA
99HOLXDXA	3-3-04	CSMI
99HOLXDXA	3-3-05	Z
99HOLXDXA	3-3-06	Cort. Thick
99HOLXDXA	3-3-07	BR
99HOLXDXA	3-4-01	Fat Mass
99HOLXDXA	3-4-02	Lean + BMC
99HOLXDXA	3-4-03	% Fat
99HOLXDXA	3-4-04	Lean Mass
99HOLXDXA	3-4-05	Total Mass
99HOLXDXA	3-4-06	Result
99HOLXDXA	3-4-07	%Fat Percentile Young Normal
99HOLXDXA	3-4-08	%Fat Percentile Age Matched
99HOLXDXA	3-4-09	Percentile Young Normal
99HOLXDXA	3-4-10	Percentile Age Matched
99HOLXDXA	3-4-11	Measure
99HOLXDXA	3-4-12	%Fat T-Score
99HOLXDXA	3-4-13	%Fat Z-Score
99HOLXDXA	3-4-14	Fat Mass (lb)
99HOLXDXA	3-4-15	Lean + BMC (lb)
99HOLXDXA	3-4-16	Lean Mass (lb)
99HOLXDXA	3-4-17	Total Mass (lb)
99HOLXDXA	3-5-01	Change vs Baseline
99HOLXDXA	3-5-02	Change vs Previous

**APEX Software DICOM Conformance Statement**

<b>Coding Scheme Designator (0008,0102)</b>	<b>Code Value (0008,0100)</b>	<b>Code Meaning (0008,0104)</b>
99HOLXDXA	3-5-03	Change per Month vs Baseline
99HOLXDXA	3-5-04	Change per Month vs Previous
99HOLXDXA	3-6-01	Height US
99HOLXDXA	3-6-02	Height Metric
99HOLXDXA	3-6-03	Weight US
99HOLXDXA	3-6-04	Weight Metric
99HOLXDXA	3-6-05	BMI
99HOLXDXA	3-6-06	L1L2L3L4 BMC
99HOLXDXA	3-6-07	Subtotal BMC
99HOLXDXA	3-6-08	Subtotal BMD
99HOLXDXA	3-6-09	Percentile
99HOLXDXA	3-7-01	Fracture Type
99HOLXDXA	3-7-02	Fracture Risk Without Prior Fracture
99HOLXDXA	3-7-03	Fracture Risk With Prior Fracture
99HOLXDXA	3-8-01	Height Posterior
99HOLXDXA	3-8-02	Height Mid
99HOLXDXA	3-8-03	Height Anterior
99HOLXDXA	3-8-04	Deformity
99HOLXDXA	3-8-05	Deformity Grade
99HOLXDXA	3-8-06	Percent Deformation Wedge
99HOLXDXA	3-8-07	Percent Deformation Biconcave
99HOLXDXA	3-8-08	Percent Deformation Crush
<b>Measures</b>		
99HOLXDXA	3-9-01	k
99HOLXDXA	3-9-02	d0
99HOLXDXA	3-9-03	ROI Width
99HOLXDXA	3-9-04	ROI Height
99HOLXDXA	3-9-05	Footnote
99HOLXDXA	3-9-06	Thickness
99HOLXDXA	3-9-07	WHO Classification
99HOLXDXA	3-9-08	Fracture Risk



**APEX Software DICOM Conformance Statement**

<b>Coding Scheme Designator (0008,0102)</b>	<b>Code Value (0008,0100)</b>	<b>Code Meaning (0008,0104)</b>
99HOLXDXA	3-9-09	Physician Comment
99HOLXDXA	3-9-10	Footnote 2
99HOLXDXA	3-9-11	Text
99HOLXDXA	3-9-12	Region Name
99HOLXDXA	3-9-13	HAL
99HOLXDXA	3-9-14	Neck Width
99HOLXDXA	3-9-15	Neck Height
99HOLXDXA	3-9-16	Neck Shaft Angle
99HOLXDXA	3-10-01	L2-L4 BMD
99HOLXDXA	3-10-02	L2-L4 T-score
99HOLXDXA	3-10-03	L2-L4 Z-score
99HOLXDXA	3-10-04	L2-L4 Change vs Vaseline
99HOLXDXA	3-10-05	L2-L4 Change vs Previous
99HOLXDXA	3-11-01	BMAD
99HOLXDXA	3-11-02	Pediatric Result Type
99HOLXDXA	3-11-03	Pediatric Result Value
99HOLXDXA	3-11-04	Pediatric Result Units
99HOLXDXA	3-11-05	Pediatric Result Adjusted Age
99HOLXDXA	5-1-01	Total Body % Fat
99HOLXDXA	5-1-02	Fat Mass/Height <sup>2</sup> (kg/m <sup>2</sup> )
99HOLXDXA	5-1-03	Android/Gynoid Ratio
99HOLXDXA	5-1-04	% Fat Trunk / % Fat Legs
99HOLXDXA	5-1-05	Trunk / Limb Fat Mass Ratio
99HOLXDXA	5-1-06	(Lean + BMC)/Height <sup>2</sup> (kg/m <sup>2</sup> )
99HOLXDXA	5-1-07	Appen. (Lean + BMC)/Height <sup>2</sup> (kg/m <sup>2</sup> )
99HOLXDXA	5-1-08	Android %Fat
99HOLXDXA	5-1-09	Gynoid %Fat
99HOLXDXA	5-1-10	Total Fat Mass (g)
99HOLXDXA	5-1-11	Total Lean + BMC Mass (g)
99HOLXDXA	5-1-12	Age

## APEX Software DICOM Conformance Statement

Coding Scheme Designator (0008,0102)	Code Value (0008,0100)	Code Meaning (0008,0104)
99HOLXDXA	5-1-13	Est. VAT Mass (g)
99HOLXDXA	5-1-14	Est. VAT Volume (cm2)
99HOLXDXA	5-1-15	Est. VAT Area (cm2)
99HOLXDXA	5-1-16	Total Lean Mass (g)
99HOLXDXA	5-1-17	Total Fat Mass (lb)
99HOLXDXA	5-1-18	Total Lean + BMC Mass (lb)
99HOLXDXA	5-1-19	Total Lean Mass (lb)
99HOLXDXA	5-2-01	Ruler ID
99HOLXDXA	5-2-02	Wholebody Ruler Length
99HOLXDXA	5-2-03	Femur Ruler Length
99HOLXDXA	5-2-04	Annotation ID
99HOLXDXA	5-2-05	Annotation Text
99HOLXDXA	5-3-01	Adjusted Age
99HOLXDXA	5-3-02	Adjusted Age Label
99HOLXDXA	5-3-03	Adjusted Age Value
99HOLXDXA	5-4-01	Scan 1 – Total Body % Fat
99HOLXDXA	5-4-02	Scan 2 – Total Body % Fat
99HOLXDXA	5-4-03	Scan 3 – Total Body % Fat
99HOLXDXA	5-4-04	Scan 4 – Total Body % Fat
99HOLXDXA	5-4-05	Scan 5 – Total Body % Fat
99HOLXDXA	5-4-06	Scan 6 – Total Body % Fat
99HOLXDXA	5-4-07	Scan 1 – Fat Mass/Height <sup>2</sup> (kg/m <sup>2</sup> )
99HOLXDXA	5-4-08	Scan 2 – Fat Mass/Height <sup>2</sup> (kg/m <sup>2</sup> )
99HOLXDXA	5-4-09	Scan 3 – Fat Mass/Height <sup>2</sup> (kg/m <sup>2</sup> )
99HOLXDXA	5-4-10	Scan 4 – Fat Mass/Height <sup>2</sup> (kg/m <sup>2</sup> )
99HOLXDXA	5-4-11	Scan 5 – Fat Mass/Height <sup>2</sup> (kg/m <sup>2</sup> )
99HOLXDXA	5-4-12	Scan 6 – Fat Mass/Height <sup>2</sup> (kg/m <sup>2</sup> )
99HOLXDXA	5-4-13	Scan 1 – Android/Gynoid Ratio
99HOLXDXA	5-4-14	Scan 2 – Android/Gynoid Ratio
99HOLXDXA	5-4-15	Scan 3 – Android/Gynoid Ratio
99HOLXDXA	5-4-16	Scan 4 – Android/Gynoid Ratio

**APEX Software DICOM Conformance Statement**

<b>Coding Scheme Designator (0008,0102)</b>	<b>Code Value (0008,0100)</b>	<b>Code Meaning (0008,0104)</b>
99HOLXDXA	5-4-17	Scan 5 – Android/Gynoid Ratio
99HOLXDXA	5-4-18	Scan 6 – Android/Gynoid Ratio
99HOLXDXA	5-4-19	Scan 1 – % Fat Trunk / % Fat Legs
99HOLXDXA	5-4-20	Scan 2 – % Fat Trunk / % Fat Legs
99HOLXDXA	5-4-21	Scan 3 – % Fat Trunk / % Fat Legs
99HOLXDXA	5-4-22	Scan 4 – % Fat Trunk / % Fat Legs
99HOLXDXA	5-4-23	Scan 5 – % Fat Trunk / % Fat Legs
99HOLXDXA	5-4-24	Scan 6 – % Fat Trunk / % Fat Legs
99HOLXDXA	5-4-25	Scan 1 – Trunk / Limb Fat Mass Ratio
99HOLXDXA	5-4-26	Scan 2 – Trunk / Limb Fat Mass Ratio
99HOLXDXA	5-4-27	Scan 3 – Trunk / Limb Fat Mass Ratio
99HOLXDXA	5-4-28	Scan 4 – Trunk / Limb Fat Mass Ratio
99HOLXDXA	5-4-29	Scan 5 – Trunk / Limb Fat Mass Ratio
99HOLXDXA	5-4-30	Scan 6 – Trunk / Limb Fat Mass Ratio
99HOLXDXA	5-4-31	Scan 1 – Lean/Height2 (kg/m2)
99HOLXDXA	5-4-32	Scan 2 – Lean/Height2 (kg/m2)
99HOLXDXA	5-4-33	Scan 3 – Lean/Height2 (kg/m2)
99HOLXDXA	5-4-34	Scan 4 – Lean/Height2 (kg/m2)
99HOLXDXA	5-4-35	Scan 5 – Lean/Height2 (kg/m2)
99HOLXDXA	5-4-36	Scan 6 – Lean/Height2 (kg/m2)
99HOLXDXA	5-4-37	Scan 1 – Append. Lean/Height2 (kg/m2)
99HOLXDXA	5-4-38	Scan 2 – Append. Lean/Height2 (kg/m2)
99HOLXDXA	5-4-39	Scan 3 – Append. Lean/Height2 (kg/m2)
99HOLXDXA	5-4-40	Scan 4 – Append. Lean/Height2 (kg/m2)
99HOLXDXA	5-4-41	Scan 5 – Append. Lean/Height2 (kg/m2)
99HOLXDXA	5-4-42	Scan 6 – Append. Lean/Height2 (kg/m2)
99HOLXDXA	5-4-43	Scan 1 – Android %Fat

**APEX Software DICOM Conformance Statement**

<b>Coding Scheme Designator (0008,0102)</b>	<b>Code Value (0008,0100)</b>	<b>Code Meaning (0008,0104)</b>
99HOLXDXA	5-4-44	Scan 2 – Android %Fat
99HOLXDXA	5-4-45	Scan 3 – Android %Fat
99HOLXDXA	5-4-46	Scan 4 – Android %Fat
99HOLXDXA	5-4-47	Scan 5 – Android %Fat
99HOLXDXA	5-4-48	Scan 6 – Android %Fat
99HOLXDXA	5-4-49	Scan 1 – Gynoid %Fat
99HOLXDXA	5-4-50	Scan 2 – Gynoid %Fat
99HOLXDXA	5-4-51	Scan 3 – Gynoid %Fat
99HOLXDXA	5-4-52	Scan 4 – Gynoid %Fat
99HOLXDXA	5-4-53	Scan 5 – Gynoid %Fat
99HOLXDXA	5-4-54	Scan 6 – Gynoid %Fat
99HOLXDXA	5-4-55	Scan 1 – Total Fat Mass (g)
99HOLXDXA	5-4-56	Scan 2 – Total Fat Mass (g)
99HOLXDXA	5-4-57	Scan 3 – Total Fat Mass (g)
99HOLXDXA	5-4-58	Scan 4 – Total Fat Mass (g)
99HOLXDXA	5-4-59	Scan 5 – Total Fat Mass (g)
99HOLXDXA	5-4-60	Scan 6 – Total Fat Mass (g)
99HOLXDXA	5-4-61	Scan 1 – Total Lean Mass (g)
99HOLXDXA	5-4-62	Scan 2 – Total Lean Mass (g)
99HOLXDXA	5-4-63	Scan 3 – Total Lean Mass (g)
99HOLXDXA	5-4-64	Scan 4 – Total Lean Mass (g)
99HOLXDXA	5-4-65	Scan 5 – Total Lean Mass (g)
99HOLXDXA	5-4-66	Scan 6 – Total Lean Mass (g)
99HOLXDXA	5-4-67	Scan 1 – Total Mass
99HOLXDXA	5-4-68	Scan 2 – Total Mass
99HOLXDXA	5-4-69	Scan 3 – Total Mass
99HOLXDXA	5-4-70	Scan 4 – Total Mass
99HOLXDXA	5-4-71	Scan 5 – Total Mass
99HOLXDXA	5-4-72	Scan 6 – Total Mass

**Table 8.3.1-4**

**Private Context Group – Regions and Labels**

<b>Coding Scheme Designator (0008,0102)</b>	<b>Code Value (0008,0100)</b>	<b>Code Meaning (0008,0104)</b>
<b>Regions</b>		
99HOLXDXA	4-1-01	Total
99HOLXDXA	4-1-02	Subtotal
99HOLXDXA	4-1-03	Scan 1
99HOLXDXA	4-1-04	Scan 2
99HOLXDXA	4-1-05	Scan 3
99HOLXDXA	4-1-06	Scan 4
99HOLXDXA	4-1-07	Scan 5
99HOLXDXA	4-1-08	Scan 6
99HOLXDXA	4-1-09	Scan 7
99HOLXDXA	4-1-10	Scan 8
99HOLXDXA	4-1-11	Scan 9
99HOLXDXA	4-1-12	Scan 10
99HOLXDXA	4-2-01	L1
99HOLXDXA	4-2-02	L2
99HOLXDXA	4-2-03	L3
99HOLXDXA	4-2-04	L4
99HOLXDXA	4-2-05	L5
99HOLXDXA	4-2-06	T4
99HOLXDXA	4-2-07	T5
99HOLXDXA	4-2-08	T6
99HOLXDXA	4-2-09	T7
99HOLXDXA	4-2-10	T8
99HOLXDXA	4-2-11	T9
99HOLXDXA	4-2-12	T10
99HOLXDXA	4-2-13	T11
99HOLXDXA	4-2-14	T12
99HOLXDXA	4-2-15	L1-L2
99HOLXDXA	4-2-16	L1,L3

**APEX Software DICOM Conformance Statement**

<b>Coding Scheme Designator (0008,0102)</b>	<b>Code Value (0008,0100)</b>	<b>Code Meaning (0008,0104)</b>
99HOLXDXA	4-2-17	L1,L4
99HOLXDXA	4-2-18	L2-L3
99HOLXDXA	4-2-19	L2,L4
99HOLXDXA	4-2-20	L3-L4
99HOLXDXA	4-2-21	L1-L3
99HOLXDXA	4-2-22	L1-L2,L4
99HOLXDXA	4-2-23	L1,L3-L4
99HOLXDXA	4-2-24	L2-L4
99HOLXDXA	4-2-25	L1-L4
99HOLXDXA	4-2-26	L2,L5
99HOLXDXA	4-2-27	L3,L5
99HOLXDXA	4-2-28	L4-L5
99HOLXDXA	4-2-29	L2-L3,L5
99HOLXDXA	4-2-30	L2,L4-L5
99HOLXDXA	4-2-31	L3-L5
99HOLXDXA	4-2-32	L2-L5
99HOLXDXA	4-3-01	AP Total
99HOLXDXA	4-3-02	Mid L1
99HOLXDXA	4-3-03	Mid L2
99HOLXDXA	4-3-04	Mid L3
99HOLXDXA	4-3-05	Mid L4
99HOLXDXA	4-3-06	Mid L5
99HOLXDXA	4-3-07	Mid Total
99HOLXDXA	4-3-08	Lateral L1
99HOLXDXA	4-3-09	Lateral L2
99HOLXDXA	4-3-10	Lateral L3
99HOLXDXA	4-3-11	Lateral L4
99HOLXDXA	4-3-12	Lateral L5
99HOLXDXA	4-3-13	Lateral Total
99HOLXDXA	4-3-14	AP L1
99HOLXDXA	4-3-15	AP L2

## APEX Software DICOM Conformance Statement

Coding Scheme Designator (0008,0102)	Code Value (0008,0100)	Code Meaning (0008,0104)
99HOLXDXA	4-3-16	AP L3
99HOLXDXA	4-3-17	AP L4
99HOLXDXA	4-3-18	AP L5
99HOLXDXA	4-4-01	Trochanter
99HOLXDXA	4-4-02	Inter
99HOLXDXA	4-4-03	Neck
99HOLXDXA	4-4-04	Wards
99HOLXDXA	4-4-05	Narrow Neck
99HOLXDXA	4-4-06	Inter Trochanter
99HOLXDXA	4-4-07	Femur Shaft
99HOLXDXA	4-4-08	Neck Shaft Angle
99HOLXDXA	4-4-09	Left
99HOLXDXA	4-4-10	Right
99HOLXDXA	4-4-11	Mean
99HOLXDXA	4-4-12	Diff
99HOLXDXA	4-5-01	UD
99HOLXDXA	4-5-02	MID
99HOLXDXA	4-5-03	1/3
99HOLXDXA	4-6-01	Head
99HOLXDXA	4-6-02	L Arm
99HOLXDXA	4-6-03	R Arm
99HOLXDXA	4-6-04	L Ribs
99HOLXDXA	4-6-05	R Ribs
99HOLXDXA	4-6-06	T Spine
99HOLXDXA	4-6-07	L Spine
99HOLXDXA	4-6-08	Pelvis
99HOLXDXA	4-6-09	L Leg
99HOLXDXA	4-6-10	R Leg
99HOLXDXA	4-6-11	Trunk
99HOLXDXA	4-7-01	R1
99HOLXDXA	4-7-02	R2

**APEX Software DICOM Conformance Statement**

<b>Coding Scheme Designator (0008,0102)</b>	<b>Code Value (0008,0100)</b>	<b>Code Meaning (0008,0104)</b>
99HOLXDXA	4-7-03	R3
99HOLXDXA	4-7-04	R4
99HOLXDXA	4-7-05	R5
99HOLXDXA	4-7-06	R6
99HOLXDXA	4-7-07	R7
99HOLXDXA	4-7-08	R8
99HOLXDXA	4-7-09	R9
99HOLXDXA	4-7-10	R10
99HOLXDXA	4-7-11	R11
99HOLXDXA	4-7-12	R12
99HOLXDXA	4-7-13	R13
99HOLXDXA	4-7-14	Net
99HOLXDXA	4-7-15	Global
<b>Labels</b>		
99HOLXDXA	4-8-01	Ruler A
99HOLXDXA	4-8-02	Ruler B
99HOLXDXA	4-8-03	Ruler C
99HOLXDXA	4-8-04	Ruler D
99HOLXDXA	4-8-05	Ruler E
99HOLXDXA	4-8-06	Ruler F
99HOLXDXA	4-9-01	Major Osteoporotic Fracture Risk
99HOLXDXA	4-9-02	Hip Fracture Risk
99HOLXDXA	4-9-03	Reported Fracture Risk Factors
99HOLXDXA	4-9-04	FRAX Limits
99HOLXDXA	4-9-05	FRAX Version
99HOLXDXA	4-9-06	FRAX Disclaimer 1
99HOLXDXA	4-9-07	FRAX Disclaimer 2
99HOLXDXA	4-10-01	Standard Deviation
99HOLXDXA	4-10-02	Automatic IVA Assessment
99HOLXDXA	4-11-01	Results Type
99HOLXDXA	4-11-02	BCA Results



<b>Coding Scheme Designator (0008,0102)</b>	<b>Code Value (0008,0100)</b>	<b>Code Meaning (0008,0104)</b>
99HOLXDXA	4-11-03	Extended Hip ROC Results
99HOLXDXA	4-11-04	Padiatric Results
99HOLXDXA	4-12-01	HAL
99HOLXDXA	4-13-01	Annotation 1
99HOLXDXA	4-13-02	Annotation 2

### 8.3.2. Template Specifications

#### Private Template TID 6000 –Structured Report Document Contents

	NL	Rel with Parent	VT	Concept Name	VM	Req Type	Condition	Value Set Constraint
1			CONTAINER	EV(2-0-01, 99HOLXDXA, “Hologic DXA Structured Report”	1	M		Root Node
2	>	CONTAINS	CONTAINER	DCID (8.3.1-1) Report Types	1-n	M		
3	>>	CONTAINS	INCLUDE	TID (6017) Scan Information	1-2	M		
4	>>	CONTAINS	INCLUDE	TID (6001) Analysis Results	1-n	M		
5	>>	CONTAINS	NUM	EV(2-3-01, 99HOLXDXA, DAP”)	1	MC	If enabled	UNITS=E V(cGy*cm 2, UCUM, “cGy*cm2 ”)
6	>>	CONTAINS	TEXT	EV(2-1-11, 99HOLXDXA, Reference Curve Source”)	1	M		
7	>	CONTAINS	TEXT	EV(2-4-01, 99HOLXDXA, “Patient Height”	1	M		
8	>	CONTAINS	TEXT	EV(2-4-02, 99HOLXDXA, “Patient Weight”	1	M		
9	>	CONTAINS	TEXT	EV(2-4-03, 99HOLXDXA, “Ethnicity”	1	M		

## APEX Software DICOM Conformance Statement

	NL	Rel with Parent	VT	Concept Name	VM	Req Type	Condition	Value Set Constraint
10		CONTAINS	TEXT	EV(2-4-04, 99HOLXDX A, "Menopause Age")	1	MC	If value exists	

### Private Template TID 6001 – Analysis Results

	NL	Rel with Parent	VT	Concept Name	VM	Req Type	Condition	Value Set Constraint
1			CONTAINER	DT (See Table 8.1-4.2)	1	M		
2	>	CONTAINS	INCLUDE	TID (6002) BMD Results	1-n	MC	IFF BMD or Extended AP Lumbar Spine Report  If the region exists	
3	>	CONTAINS	INCLUDE	TID (6003) Standardized BMD Results	1-n	MC	IFF Standardized BMD Report	
4	>	CONTAINS	INCLUDE	TID (6004) Combined AP/Lateral Results	1-n	MC	IFF Combined AP/Lateral Report	
5	>	CONTAINS	INCLUDE	TID (6005) HSA Results	1-n	MC	IFF Hip Structured Analysis Report	
6		CONTAINS	NUM	EV(3-9-16, 99HOLXDXA, "Neck Shaft Angle")	1	MC	IFF Hip Structured Analysis Report	UNITS=E V(degrees, UCUM, "degrees")
7	>	CONTAINS	INCLUDE	TID (6006) Body Composition Results	1-n	MC	IFF Research Body Composition Report	
8	>	CONTAINS	INCLUDE	TID (6007) Body Composition with BMC Results	1-n	MC	IFF Body Composition with BMC Report	
9	>	CONTAINS	INCLUDE	TID (6008) Clinical Body Composition Results	1-n	MC	IFF Clinical Body Composition (BCA) Report	
10	>	CONTAINS	INCLUDE	TID (6009) Adipose Indices	1-n	MC	IFF Clinical Body Composition (BCA) Report	

## APEX Software DICOM Conformance Statement

	NL	Rel with Parent	VT	Concept Name	VM	Req Type	Condition	Value Set Constraint
11	>	CONTAINS	INCLUDE	TID (6009) Lean + BMC Indices	1-n	MC	IFF Clinical Body Composition (BCA) Report	
12	>	CONTAINS	INCLUDE	TID (6010) BMD ROC Results	1-n	MC	IFF BMD ROC Report (other than Extended Hip ROC)	
13	>	CONTAINS	CONTAINER	EV(3-1-01, 99HOLXDXA, "Region")	1-n	MC	IFF Extended Hip ROC Report	
14	>>	CONTAINS	TEXT	EV(3-9-12, 99HOLXDXA, "Region Name")	1	M		
15	>>	CONTAINS	INCLUDE	TID (6010) BMD ROC Results	1-n	M		
16	>	CONTAINS	INCLUDE	TID (6011) Body Composition ROC Results	1-n	MC	IFF Body Composition ROC Report	
17	>	CONTAINS	INCLUDE	TID (6012) Wholebody Rulers	1-n	UC	If analysis exists	
18	>	CONTAINS	CONTAINER	EV(2-2-14, 99HOLXDXA, "10-year Fracture Risk")			If configured and analysis exists	
19	>>	CONTAINS	INCLUDE	TID (6013) 10-year Fracture Risk	2	MC	If reporting conditions are met	
20	>>	CONTAINS	TEXT	EV(4-9-03, 99HOLXDXA, "Reported Fracture Risk Factors")	1	MC	If factors exist	
21	>>	CONTAINS	TEXT	EV(4-9-04, 99HOLXDXA, "FRAX Limits")	1	M		
22	>>	CONTAINS	TEXT	EV(4-9-05, 99HOLXDXA, "FRAX Version")	1	M		
	>>	CONTAINS	TEXT	EV(4-9-06, 99HOLXDXA, "FRAX Disclaimer 1")	1	M		
23	>>	CONTAINS	TEXT	EV(4-9-07, 99HOLXDXA, "FRAX Disclaimer 2")	1	M		
24	>	CONTAINS	INCLUDE	TID(6014), Extended Hip ROC Results	1-n	MC	IFF Extended Hip ROC Report	

## APEX Software DICOM Conformance Statement

	NL	Rel with Parent	VT	Concept Name	VM	Req Type	Condition	Value Set Constraint
25	>	CONTAINS	INCLUDE	TID(6015), IVA Results	1-n	MC	IFF IVA Report And If the values are present	
26	>	CONTAINS	INCLUDE	TID(6016), Standard Deviation for IVA Results	1	MC	IFF IVA Report	
27	>	CONTAINS	NUM	EV(3-9-01, 99HOLXDXA, "k")	1	MC	If BMD Report and If value present	UNITS=E V(1, UCUM, "no units")
28	>	CONTAINS	NUM	EV(3-9-02, 99HOLXDXA, "d0")	1	MC	If BMD Report and If value present	UNITS=E V(1, UCUM, "no units")
29	>	CONTAINS	NUM	EV(3-9-03, 99HOLXDXA, "ROI Width")	1	MC	If BMD Report and If value present	UNITS=E V(1, UCUM, "no units")
30	>	CONTAINS	NUM	EV(3-9-04, 99HOLXDXA, "ROI Height")	1	MC	If BMD Report and If value present	UNITS=E V(1, UCUM, "no units")
31	>	CONTAINS	NUM	EV(3-9-06, 99HOLXDXA, "Thickness")	1	MC	If BMD Report and If value present	UNITS=E V(1, UCUM, "no units")
32	>	CONTAINS	TEXT	EV(3-9-05, 99HOLXDXA, "Footnote")	1	MC	If value present	
33	>	CONTAINS	TEXT	EV(3-9-08, 99HOLXDXA, "Fracture Risk")	1	MC	If Hip Scan And If value present	
34	>	CONTAINS	TEXT	EV(3-9-09, 99HOLXDXA, "Physician Comment")	1	MC	If value present	
35	>	CONTAINS	NUM	EV(3-9-13, 99HOLXDXA, "HAL")	1	MC	If Hip Scan And If value present	UNITS=E V(mm, UCUM, "mm")
36	>	CONTAINS	NUM	EV(3-9-14, 99HOLXDXA, "Neck Width")	1	MC	If Hip Scan And If value present	UNITS=E V(1, UCUM, "no units")

## APEX Software DICOM Conformance Statement

	NL	Rel with Parent	VT	Concept Name	VM	Req Type	Condition	Value Set Constraint
37	>	CONTAINS	NUM	EV(3-9-15, 99HOLXDXA, "Neck Height")	1	MC	If Hip Scan And If value present	UNITS=E V(1, UCUM, "no units")
38	>	CONTAINS	INCLUDE	TID (6018) Femur Rulers	1-n	UC	If analysis exists	
39	>	CONTAINS	INCLUDE	TID (6019) Femur Annotations	1-n	UC	If SE Femur reports And If annotations are present	
40	>	CONTAINS	INCLUDE	TID (6020) Pediatric Results	1-n	MC	If pediatric report And If value present	

### Private Template TID 6002: BMD Results

	NL	Rel with Parent	VT	Concept Name	VM	Req Type	Condition	Value Set Constraint
1			CONTAINER	DT (2-2-00, 99HOLXDXA, Results Set Title)	1	M		
2	>	CONTAINS	TEXT	EV(3-1-01, 99HOLXDXA, "Region")	1	M		
3	>	CONTAINS	NUM	EV(3-1-02, 99HOLXDXA, "Area")	1	U		UNITS=EV(cm2, UCUM, "cm2")
4	>	CONTAINS	NUM	EV(3-1-03, 99HOLXDXA, "BMC")	1	U		UNITS=EV(g, UCUM, "g")
5	>	CONTAINS	NUM	EV(3-1-04, 99HOLXDXA, "BMD")	1	U		UNITS=EV(g/cm2, UCUM, "g/cm2")
6	>	CONTAINS	NUM	EV(3-1-05, 99HOLXDXA, "T-Score")	1	U		UNITS=EV(1, UCUM, "no units")
7	>	CONTAINS	NUM	EV(3-1-07, 99HOLXDXA, "Peak Reference")	1	U		UNITS=EV(% , UCUM, "Percent")
8	>	CONTAINS	NUM	EV(3-1-06, 99HOLXDXA, "Z-Score")	1	U		UNITS=EV(1, UCUM, "no units")
9	>	CONTAINS	NUM	EV(3-1-08, 99HOLXDXA, "Age Matched")	1	U		UNITS=EV(% , UCUM, "Percent")

## APEX Software DICOM Conformance Statement

	NL	Rel with Parent	VT	Concept Name	VM	Req Type	Condition	Value Set Constraint
10	>	CONTAINS	NUM	EV(3-11-01, 99HOLXDXA, "BMAD")	1	UC	If pediatric hip or spine reports; If configured	UNITS=EV(g/cm3, UCUM, "g/cm3")

### Private Template TID 6003: Standardized BMD Results

	NL	Rel with Parent	VT	Concept Name	VM	Req Type	Condition	Value Set Constraint
1			CONTAINER	DT (2-2-00, 99HOLXDXA, Results Set Title)	1	M		
2	>	CONTAINS	TEXT	EV(3-1-01, 99HOLXDXA, "Region")	1	M		
3	>	CONTAINS	NUM	EV(3-2-01, 99HOLXDXA, "Standardized BMD")	1	M		UNITS=EV(mg/cm2, UCUM, "mg/cm2")
4	>	CONTAINS	NUM	EV(3-1-05, 99HOLXDXA, "T-Score")	1	U		UNITS=EV(1, UCUM, "no units")
5	>	CONTAINS	NUM	EV(3-1-07, 99HOLXDXA, "Peak Reference")	1	U		UNITS=EV(%, UCUM, "Percent")
6	>	CONTAINS	NUM	EV(3-1-06, 99HOLXDXA, "Z-Score")	1	U		UNITS=EV(1, UCUM, "no units")
7	>	CONTAINS	NUM	EV(3-1-08, 99HOLXDXA, "Age Matched")	1	U		UNITS=EV(%, UCUM, "Percent")

### Private Template TID 6004: Combined AP/Lateral Results

	NL	Rel with Parent	VT	Concept Name	VM	Req Type	Condition	Value Set Constraint
1			CONTAINER	DT (2-2-03, 99HOLXDXA, Combined AP/Lateral Results)	1	M		
2	>	CONTAINS	TEXT	EV(3-1-01, 99HOLXDXA, "Region")	1	M		
3	>	CONTAINS	NUM	EV(3-1-04, 99HOLXDXA, "BMD")	1	U		UNITS=EV(g/cm2, UCUM, "g/cm2")
4	>	CONTAINS	NUM	EV(3-2-02, 99HOLXDXA, "WA-BMD")	1	U		UNITS=EV(g/cm3, UCUM, "g/cm3")

## APEX Software DICOM Conformance Statement

	NL	Rel with Parent	VT	Concept Name	VM	Req Type	Condition	Value Set Constraint
5	>	CONTAINS	NUM	EV(3-1-05, 99HOLXDXA, "T-Score")	1	U		UNITS=EV(1, UCUM, "no units")
6	>	CONTAINS	NUM	EV(3-1-07, 99HOLXDXA, "Peak Reference")	1	U		UNITS=EV(% , UCUM, "Percent")
7	>	CONTAINS	NUM	EV(3-1-06, 99HOLXDXA, "Z-Score")	1	U		UNITS=EV(1, UCUM, "no units")
8	>	CONTAINS	NUM	EV(3-1-08, 99HOLXDXA, "Age Matched")	1	U		UNITS=EV(% , UCUM, "Percent")

### Private Template TID 6005: HSA Results

	NL	Rel with Parent	VT	Concept Name	VM	Req Type	Condition	Value Set Constraint
1			CONTAINER	DT (2-2-00, 99HOLXD XA, Results Set Title)	1	M		
2	>	CONTAINS	TEXT	EV(3-1-01, 99HOLXD XA, "Region")	1	M		
3	>	CONTAINS	NUM	EV(3-3-01, 99HOLXD XA, "Sub Peri. Width")	1	M		UNITS=EV(cm, UCUM, "cm")
4	>	CONTAINS	NUM	EV(3-3-02, 99HOLXD XA, "Endo Cort. Width")	1	M		UNITS=EV(cm, UCUM, "cm")
5	>	CONTAINS	NUM	EV(3-3-03, 99HOLXD XA, "CSA")	1	M		UNITS=EV(cm <sup>2</sup> , UCUM, "cm <sup>2</sup> ")
6	>	CONTAINS	NUM	EV(3-3-04, 99HOLXD XA, "CSMI")	1	M		UNITS=EV(cm <sup>4</sup> , UCUM, "cm <sup>4</sup> ")
7	>	CONTAINS	NUM	EV(3-3-05, 99HOLXD XA, "Z")	1	M		UNITS=EV(cm <sup>3</sup> , UCUM, "cm <sup>3</sup> ")

## APEX Software DICOM Conformance Statement

	NL	Rel with Parent	VT	Concept Name	VM	Req Type	Condition	Value Set Constraint
8	>	CONTAINS	NUM	EV(3-3-06, 99HOLXD XA, "Cort. Thick")	1	M		UNITS=EV(cm, UCUM, "cm")
9	>	CONTAINS	NUM	EV(3-3-07, 99HOLXD XA, "BR")	1	M		UNITS=EV(1, UCUM, "no units")

### Private Template TID 6006: Body Composition Results

	NL	Rel with Parent	VT	Concept Name	VM	Req Type	Condition	Value Set Constraint
1			CONTAINER	DT (2-2-00, 99HOLXD XA, Results Set Title)	1	M		
2	>	CONTAINS	TEXT	EV(3-1-01, 99HOLXD XA, "Region")	1	M		
3	>	CONTAINS	NUM	EV(3-4-01, 99HOLXD XA, "Fat Mass")	1	M	XOR Row 6	UNITS=EV(g, UCUM, "g")
4	>	CONTAINS	NUM	EV(3-4-02, 99HOLXD XA, "Lean + BMC")	1	M	XOR Row 7	UNITS=EV(g, UCUM, "g")
5	>	CONTAINS	NUM	EV(3-4-03, 99HOLXD XA, "% Fat")	1	M		UNITS=EV(%, UCUM, "Percent")
6	>	CONTAINS	NUM	EV(3-4-14, 99HOLXD XA, "Fat Mass")	1	M	XOR Row 3	UNITS=EV(g, UCUM, "lb")
7	>	CONTAINS	NUM	EV(3-4-15, 99HOLXD XA, "Lean + BMC")	1	M	XOR Row 4	UNITS=EV(g, UCUM, "lb")

### Private Template TID 6007: Body Composition with BMC Results

	NL	Rel with Parent	VT	Concept Name	VM	Req Type	Condition	Value Set Constraint
1			CONTAINER	DT (2-2-00, 99HOLXDX A, Results Set Title)	1	M		
2	>	CONTAINS	TEXT	EV(3-1-01, 99HOLXDX A, "Region")	1	M		



## APEX Software DICOM Conformance Statement

	NL	Rel with Parent	VT	Concept Name	V M	Req Type	Condition	Value Set Constraint
3	>	CONTAINS	NUM	EV(3-1-02, 99HOLXDX A, "Area")	1	M		UNITS=EV(cm2, UCUM, "cm2")
4	>	CONTAINS	NUM	EV(3-1-03, 99HOLXDX A, "BMC")	1	M		UNITS=EV(g, UCUM, "g")
5	>	CONTAINS	NUM	EV(3-1-04, 99HOLXDX A, "BMD")	1	M		UNITS=EV(g/cm2, UCUM, "g/cm2")
6	>	CONTAINS	NUM	EV(3-4-01, 99HOLXDX A, "Fat Mass")	1	M	XOR Row 9	UNITS=EV(g, UCUM, "g")
7	>	CONTAINS	NUM	EV(3-4-04, 99HOLXDX A, "Lean Mass")	1	M	XOR Row 10	UNITS=EV(g, UCUM, "g")
8	>	CONTAINS	NUM	EV(3-4-02, 99HOLXDX A, "Lean + BMC")	1	M	XOR Row 11	UNITS=EV(g, UCUM, "g")
9	>	CONTAINS	NUM	EV(3-4-05, 99HOLXDX A, "Total Mass")	1	M	XOR Row 12	UNITS=EV(g, UCUM, "g")
10	>	CONTAINS	NUM	EV(3-4-03, 99HOLXDX A, "% Fat")	1	M		UNITS=EV(% , UCUM, "Percent")
11	>	CONTAINS	NUM	EV(3-4-14, 99HOLXDX A, "Fat Mass")	1	M	XOR Row 4	UNITS=EV(g, UCUM, "g")
12	>	CONTAINS	NUM	EV(3-4-16, 99HOLXDX A, "Lean Mass")	1	M	XOR Row 5	UNITS=EV(g, UCUM, "g")
13	>	CONTAINS	NUM	EV(3-4-15, 99HOLXDX A, "Lean + BMC")	1	M	XOR Row 6	UNITS=EV(g, UCUM, "g")
14	>	CONTAINS	NUM	EV(3-4-17, 99HOLXDX A, "Total Mass")	1	M	XOR Row 7	UNITS=EV(g, UCUM, "g")

**Private Template TID 6008: Clinical Body Composition Results**

	NL	Rel with Parent	VT	Concept Name	VM	Req Type	Condition	Value Set Constraint
1			CONTAINER	DT (2-2-00, 99HOLXDX A, Results Set Title)	1	M		
2	>	CONTAINS	TEXT	EV(3-1-01, 99HOLXDX A, "Region")	1	M		
3	>	CONTAINS	NUM	EV(3-4-01, 99HOLXDX A, "Fat Mass")	1	M	XOR Row 11	UNITS=EV (g, UCUM, "g")
4	>	CONTAINS	NUM	EV(3-4-02, 99HOLXDX A, "Lean + BMC")	1	M	XOR Row 12	UNITS=EV (g, UCUM, "g")
5	>	CONTAINS	NUM	EV(3-4-05, 99HOLXDX A, "Total Mass")	1	M	XOR Row 13	UNITS=EV (g, UCUM, "g")
6	>	CONTAINS	NUM	EV(3-4-03, 99HOLXDX A, "% Fat")	1	M		UNITS=EV (% , UCUM, "Percent")
7	>	CONTAINS	NUM	EV(3-4-13, 99HOLXDX A, "%Fat T-Score")	1	MC	XOR Row 9	UNITS=EV (1, UCUM, "no units")
8	>	CONTAINS	NUM	EV(3-4-14, 99HOLXDX A, "%Fat Z-Score")	1	MC	XOR Row 10	UNITS=EV (1, UCUM, "no units")
9	>	CONTAINS	NUM	EV(3-4-08, 99HOLXDX A, "%Fat Percentile Young Normal")	1	MC	XOR Row 7	UNITS=EV (1, UCUM, "no units")
10	>	CONTAINS	NUM	EV(3-1-08, 99HOLXDX A, "%Fat Percentile Age Matched")	1	MC	XOR Row 8	UNITS=EV (% , UCUM, "Percent")
11	>	CONTAINS	NUM	EV(3-4-14, 99HOLXDX A, "Fat Mass")	1	M	XOR Row 3	UNITS=EV (g, UCUM, "g")
12	>	CONTAINS	NUM	EV(3-4-15, 99HOLXDX A, "Lean + BMC")	1	M	XOR Row 4	UNITS=EV (g, UCUM, "g")

**APEX Software DICOM Conformance Statement**

	NL	Rel with Parent	VT	Concept Name	VM	Req Type	Condition	Value Set Constraint
13	>	CONTAINS	NUM	EV(3-4-17, 99HOLXDXA, "Total Mass")	1	M	XOR Row 5	UNITS=EV (g, UCUM, "g")

**Private Template TID 6009: Adipose Indices or Lean + BMC Indices**

	NL	Rel with Parent	VT	Concept Name	VM	Req Type	Condition	Value Set Constraint
1			CONTAINER	DT (2-2-00, 99HOLXDXA, Results Set Title)	1	M		
2	>	CONTAINS	TEXT	EV(3-4-12, 99HOLXDXA, "Measure")	1	M		
3	>	CONTAINS	NUM	EV(3-4-07, 99HOLXDXA, "Result")	1	M		UNITS=EV (1, UCUM, "no units")
4	>	CONTAINS	NUM	EV(3-4-08, 99HOLXDXA, "Percentile Young Normal")	1	MC	XOR Row 6	UNITS=EV (1, UCUM, "no units")
5	>	CONTAINS	NUM	EV(3-4-09, 99HOLXDXA, "Percentile Age Matched")	1	MC	XOR Row 7	UNITS=EV (1, UCUM, "no units")
6	>	CONTAINS	NUM	EV(3-1-05, 99HOLXDXA, "T-Score")	1	MC	XOR Row 4	UNITS=EV (1, UCUM, "no units")
7	>	CONTAINS	NUM	EV(3-1-06, 99HOLXDXA, "Z-Score")	1	MC	XOR Row 5	UNITS=EV (1, UCUM, "no units")

**Private Template TID 6010: BMD ROC Results**

	NL	Rel with Parent	VT	Concept Name	VM	Req Type	Condition	Value Set Constraint
1			CONTAINER	DT (2-2-00, 99HOLXDXA, Results Set Title)	1	M		
2	>	CONTAINS	DATE	EV(2-1-02, 99HOLXDXA, "Scan Date")	1	M		
3	>	CONTAINS	NUM	EV(5-1-12, 99HOLXDXA, "Age")	1	M		UNITS=EV (1, UCUM, "no units")

## APEX Software DICOM Conformance Statement

	NL	Rel with Parent	VT	Concept Name	VM	Req Type	Condition	Value Set Constraint
4	>	CONTAINS	NUM	EV(3-1-04, 99HOLXD XA, "BMD")	1	M		UNITS=E V(g/cm2, UCUM, "g/cm2")
5	>	CONTAINS	NUM	EV(3-1-05, 99HOLXD XA, "T-Score")	1	M		UNITS=E V(1, UCUM, "no units")
6	>	CONTAINS	TEXT	EV(3-5-01, 99HOLXD XA, "BMD Change vs Baseline")	1	MC	Except for the oldest scan	
7	>	CONTAINS	TEXT	EV(3-5-02, 99HOLXD XA, "BMD Change vs Previous")	1	MC	Except for the oldest scan	
8	>	CONTAINS	NUM	EV(3-10-01, 99HOLXD XA, "L2-L4 BMD")	1	MC	If configured	UNITS=E V(g/cm2, UCUM, "g/cm2")
9	>	CONTAINS	NUM	EV(3-10-02, 99HOLXD XA, "L2-L4 T-Score")	1	MC	If configured	UNITS=E V(1, UCUM, "no units")
10	>	CONTAINS	TEXT	EV(3-10-03, 99HOLXD XA, "L2-L4 BMD Change vs Baseline")	1	MC	If configured, except for the oldest scan	
11	>	CONTAINS	TEXT	EV(3-10-04, 99HOLXD XA, "L2-L4 BMD Change vs Previous")	1	MC	If configured, except for the oldest scan	

### Private Template TID 6011: Body Composition ROC Results

	NL	Rel with Parent	VT	Concept Name	VM	Req Type	Condition	Value Set Constraint
1			CONTAINER	DT (2-2-00, 99HOLXDX A, Results Set Title)	1	M		
2	>	CONTAINS	TEXT	EV(3-4-12, 99HOLXDX A, "Measure")	1	M		
3	>	CONTAINS	DATE	EV(2-1-02, 99HOLXDX A, "Scan Date")	1	M		

## APEX Software DICOM Conformance Statement

	NL	Rel with Parent	VT	Concept Name	VM	Req Type	Condition	Value Set Constraint
4	>	CONTAINS	NUM	EV(5-1-12, 99HOLXDX A, "Age")	1	M		UNITS=EV (1, UCUM, "no units")
5	>	CONTAINS	NUM	EV(3-4-07, 99HOLXDX A, "Result")	1	M		UNITS=EV (1, UCUM, "no units")
6	>	CONTAINS	NUM	EV(3-4-08, 99HOLXDX A, "Percentile Young Normal")	1	MC	XOR Row 8	UNITS=EV (1, UCUM, "no units")
7	>	CONTAINS	NUM	EV(3-4-09, 99HOLXDX A, "Percentile Age Matched")	1	MC	XOR Row 9	UNITS=EV (1, UCUM, "no units")
8	>	CONTAINS	NUM	EV(3-1-05, 99HOLXDX A, "T-Score")	1	MC	XOR Row 6	UNITS=EV (1, UCUM, "no units")
9	>	CONTAINS	NUM	EV(3-1-06, 99HOLXDX A, "Z-Score")	1	MC	XOR Row 7	UNITS=EV (1, UCUM, "no units")
10	>	CONTAINS	TEXT	EV(3-5-01, 99HOLXDX A, "BMD Change vs Baseline")	1	MC	Except for the oldest scan	
11	>	CONTAINS	TEXT	EV(3-5-02, 99HOLXDX A, "BMD Change vs Previous")	1	MC	Except for the oldest scan	

### Private Template TID 6012: Wholebody Rulers

	NL	Rel with Parent	VT	Concept Name	VM	Req Type	Condition	Value Set Constraint
1			CONTAINER	DT (2-2-00, 99HOLXDXA , Results Set Title)	1	M		
2	>	CONTAINS	TEXT	EV(5-2-01, 99HOLXDXA , "Ruler ID")	1	M		
3	>	CONTAINS	NUM	EV(5-2-02, 99HOLXDXA , "Wholebody Ruler Length")	1	M		UNITS=EV(cm, UCUM, "cm")

**Private Template TID 6013: 10-year Fracture Risk**

	NL	Rel with Parent	VT	Concept Name	VM	Req Type	Condition	Value Set Constraint
1			CONTAINER	DT (2-2-00, 99HOLXD XA, Results Set Title)	1	M		
2	>	CONTAINS	TEXT	EV(3-7-01, 99HOLXD XA, "Fracture Type")	1	U		
3	>	CONTAINS	TEXT	EV(3-7-02, 99HOLXD XA, "Fracture Risk Without Prior Fracture")	1	U		
4	>	CONTAINS	TEXT	EV(3-7-03, 99HOLXD XA, "Fracture Risk With Prior Fracture")	1	U		

**Private Template TID 6014: Extended HIP ROC Results**

	NL	Rel with Parent	VT	Concept Name	VM	Req Type	Condition	Value Set Constraint
1			CONTAINER	DT (2-2-00, 99HOLXD XA, Results Set Title)	1	M		
2	>	CONTAINS	TEXT	EV(3-1-01, 99HOLXD XA, "Region")	1	MC	For the most recent scan	
3	>	CONTAINS	DATE	EV(2-1-02, 99HOLXD XA, "Scan Date")	1	M		
4	>	CONTAINS	NUM	EV(5-1-12, 99HOLXD XA, "Age")	1	M		UNITS=EV(1, UCUM, "no units")

## APEX Software DICOM Conformance Statement

	NL	Rel with Parent	VT	Concept Name	VM	Req Type	Condition	Value Set Constraint
5	>	CONTAINS	NUM	EV(3-1-04, 99HOLXD XA, "BMD")	1	M		UNITS=EV(g /cm2, UCUM, "g/cm2")
6	>	CONTAINS	NUM	EV(3-1-05, 99HOLXD XA, "T-Score")	1	M		UNITS=EV(1, UCUM, "no units")
7	>	CONTAINS	TEXT	EV(3-5-01, 99HOLXD XA, "BMD Change vs Baseline")	1	MC	Except for the oldest scan	
8	>	CONTAINS	TEXT	EV(3-5-02, 99HOLXD XA, "BMD Change vs Previous")	1	MC	Except for the oldest scan	

### Private Template TID 6015: IVA Results

	NL	Rel with Parent	VT	Concept Name	VM	Req Type	Condition	Value Set Constraint
1			CONTAINER	DT (2-2-00, 99HOLXD XA, Results Set Title)	1	M		
2	>	CONTAINS	NUM	EV(3-8-01, 99HOLXD XA, "Height Posterior")	1	U		UNITS=EV (mm, UCUM, "mm")
3	>	CONTAINS	NUM	EV(3-8-02, 99HOLXD XA, "Height Mid")	1	U		UNITS=EV (mm, UCUM, "mm")
4	>	CONTAINS	NUM	EV(3-8-03, 99HOLXD XA, "Height Anterior")	1	U		UNITS=EV (mm, UCUM, "mm")
5	>	CONTAINS	NUM	EV(3-8-06, 99HOLXD XA, "Percent Deformation Wedge")	1	U		UNITS=EV (% , UCUM, "Percent")
6	>	CONTAINS	NUM	EV(3-8-07, 99HOLXD XA, "Percent Deformation Biconcave")	1	U		UNITS=EV (% , UCUM, "Percent")

## APEX Software DICOM Conformance Statement

	NL	Rel with Parent	VT	Concept Name	VM	Req Type	Condition	Value Set Constraint
7	>	CONTAINS	NUM	EV(3-8-08, 99HOLXDXA, "Percent Deformation Crush")	1	U		UNITS=EV(%, UCUM, "Percent")
8	>	CONTAINS	TEXT	EV(3-8-04, 99HOLXDXA, "Deformity")	1	U		
9	>	CONTAINS	TEXT	EV(3-8-05, 99HOLXDXA, "Deformity Grade")	1	U		
10	>	CONTAINS	TEXT	EV(4-10-02, 99HOLXDXA, "Automatic IVA Assessment")	1	U		

### Private Template TID 6016: Standard Deviation for IVA Results

	NL	Rel with Parent	VT	Concept Name	VM	Req Type	Condition	Value Set Constraint
1			CONTAINER	DT (2-2-00, 99HOLXDXA, Results Set Title)	1	M		
2	>	CONTAINS	NUM	EV(3-8-01, 99HOLXDXA, "Height Posterior")	1	U		UNITS=EV(mm, UCUM, "mm")
3	>	CONTAINS	NUM	EV(3-8-02, 99HOLXDXA, "Height Mid")	1	U		UNITS=EV(mm, UCUM, "mm")
4	>	CONTAINS	NUM	EV(3-8-03, 99HOLXDXA, "Height Anterior")	1	U		UNITS=EV(mm, UCUM, "mm")
5	>	CONTAINS	NUM	EV(3-8-06, 99HOLXDXA, "Percent Deformation Wedge")	1	U		UNITS=EV(%, UCUM, "Percent")
6	>	CONTAINS	NUM	EV(3-8-07, 99HOLXDXA, "Percent Deformation Biconcave")	1	U		UNITS=EV(%, UCUM, "Percent")
7	>	CONTAINS	NUM	EV(3-8-08, 99HOLXDXA, "Percent Deformation Crush")	1	U		UNITS=EV(%, UCUM, "Percent")



**Private Template TID 6017: Scan Information**

	NL	Rel with Parent	VT	Concept Name	VM	Req Type	Condition	Value Set Constraint
1			CONTAINER	DT (2-1-00, 99HOLXDXA, Scan Information Title)	1	M		
2	>	CONTAINS	TEXT	EV(2-1-01, 99HOLXDXA, "Scan ID")	1	M		
3	>	CONTAINS	DATE	EV(2-1-02, 99HOLXDXA, "Scan Date")	1	M		
4	>	CONTAINS	TEXT	EV(2-1-03, 99HOLXDXA, "Scan Type")	1	M		
5	>	CONTAINS	DATE-TIME	EV(2-1-04, 99HOLXDXA, "Analysis Date Time")	1	M		
6	>	CONTAINS	TEXT	EV(2-1-05, 99HOLXDXA, "Analysis Version")	1	M		
7	>	CONTAINS	TEXT	EV(2-1-06, 99HOLXDXA, "Analysis Type")	1	M		
8	>	CONTAINS	TEXT	EV(2-1-07, 99HOLXDXA, "Operator")	1	M		
9	>	CONTAINS	TEXT	EV(2-1-08, 99HOLXDXA, "Model")	1	M		
10	>	CONTAINS	TEXT	EV(2-1-09, 99HOLXDXA, "Serial Number")	1	M		
11	>	CONTAINS	TEXT	EV(2-1-10, 99HOLXDXA, "Scan Comment")	1	M		
12	>	CONTAINS	TEXT	EV(2-1-11, 99HOLXDXA, "Reference Curve Source")	1	MC	If the curve is available; Is not displayed for a linked scan	

**Private Template TID 6018: Femur Rulers**

	NL	Rel with Parent	VT	Concept Name	VM	Req Type	Condition	Value Set Constraint
1			CONTAINER	DT (2-2-00, 99HOLXDX A, Results Set Title)	1	M		
2	>	CONTAINS	TEXT	EV(5-2-01, 99HOLXDX A, "Ruler ID")	1	M		
3	>	CONTAINS	NUM	EV(5-2-03, 99HOLXDX A, "Femur Ruler Length")	1	M		UNITS=EV (cm, UCUM, "mm")

**Private Template TID 6019: Femur Annotations**

	NL	Rel with Parent	VT	Concept Name	VM	Req Type	Condition	Value Set Constraint
1			CONTAINER	DT (2-2-00, 99HOLXDXA , Results Set Title)	1	M		
2	>	CONTAINS	TEXT	EV(5-2-04, 99HOLXDXA , "Annotation ID")	1	M		
3	>	CONTAINS	TEXT	EV(5-2-05, 99HOLXDXA , "Annotation Text")	1	M		

**Private Template TID 6020: Pediatric Results**

	NL	Rel with Parent	VT	Concept Name	VM	Req Type	Condition	Value Set Constraint
1			CONTAINER	DT (2-2-00, 99HOLXDXA, Results Set Title)	1	M		
2	>	CONTAINS	TEXT	EV(3-11-02, 99HOLXDXA, "Pediatric Result Type")	1	M		
3	>	CONTAINS	TEXT	EV(3-11-03, 99HOLXDXA, "Pediatric Result Value")	1	M		
4	>	CONTAINS	TEXT	EV(3-11-04, 99HOLXDXA, "Pediatric Result Units")	1	M		
5	>	CONTAINS	NUM	EV(3-1-06, 99HOLXDXA, "Z-Score")	1	M		UNITS=EV (1, UCUM, "no units")
6	>	CONTAINS	NUM	EV(3-4-10, 99HOLXDXA, "Percentile Age Matched")	1	M		UNITS=EV (1, UCUM, "no units")
7	>	CONTAINS	TEXT	EV(3-11-05, 99HOLXDXA, "Pediatric Result Adjusted Age")	1	M		

#### 8.4. Grayscale Image Consistency

Apex images are displayed by monitor attached to the device. There are no special technical requirements for monitors used by Apex.

#### 8.5. Standard Extended / Specialized Private SOP Classes

No Specialized or Private SOP Classes are supported.

#### 8.6. Private Transfer Syntaxes

No Private Transfer Syntaxes are supported.