

Omni[®] 4K HDR Video System

User Manual

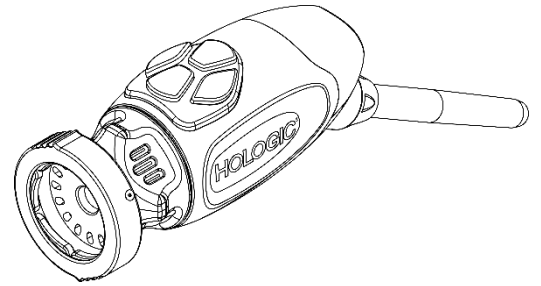
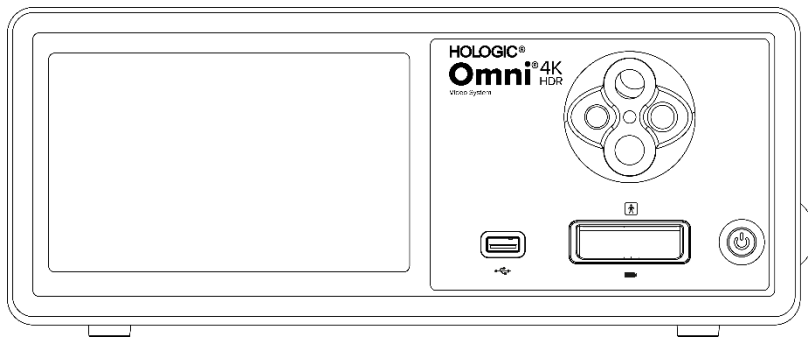

REF

83-10-5001

83-10-5120

83-10-1500

Distributed by:

HOLOGIC[®]

R_xonly

Proprietary Information

The information contained in this guide is confidential and proprietary to the manufacturer and its affiliates. It is intended solely for the information and use of parties operating and maintaining the equipment described herein. No part of this document may be distributed or disclosed in any form to third parties without prior written consent of the manufacturer.

The manufacturer reserves the right to revise this publication and to make changes from time to time without obligation to notify any person of such revisions or changes unless otherwise required by law.

Table of Contents

Proprietary Information	3
Table of Contents	4
Warnings and Cautions	6
Warnings.....	6
Cautions.....	7
Symbol Definitions	9
Product Description	11
Intended Use	12
Indications/Contraindications	12
The Camera Console	13
The Camera Heads.....	15
Compatible Equipment	16
Setup and Interconnection	17
Setting Up the Console & Monitor.....	18
Setting Up the Camera Heads.....	18
Setting Up the Light Source (applicable for 83-10-5001).....	19
Setting Up the Compatible Equipment.....	19
System Operation	20
Pre-Operative Check.....	20
White Balance.....	20
Using the Console Touchscreen Interface	21
Using the Tablet Interface	26
Troubleshooting	27
Cleaning, Reprocessing, and Maintenance	29
Cleaning the Camera Console.....	29
Reprocessing the Camera Head.....	29
Autoclave.....	29
Sterrad®	34
User Maintenance	35
Replacing the Fuses	35
Periodic Maintenance Schedule.....	35
Disposal	35

Technical Specifications 36
Table 1: System Information 36
Table 2: Safety, General Information..... 36
Table 3: Specifications.....37
Table 4: Light Source Specifications37
Table 5: Radio Communications Specifications 38
Electromagnetic Compatibility 39
Warranty and Return Policy 43
Product Warranty 43

Warnings and Cautions

Use of this equipment may present hazards to the user and/or patient. Before operating this device, please read this operating manual thoroughly and follow all warnings, cautions and instructions for use. The words **Warning**, **Caution**, and **Note** carry special meaning and should be carefully reviewed:

Warning	Indicates risks to the safety of the patient or user. Failure to follow warnings may result in injury to the patient or user.
Caution	Indicates risks of improper use and/or damage to the equipment. Failure to follow cautions may result in loss of function or product damage.
Note	Indicates special information to clarify instructions or present additional useful information.



An exclamation mark within a triangle is intended to indicate and alert the user to the presence of important operating and maintenance instructions in the manual. This symbol is used to indicate **Warnings** and **Cautions**.



Warnings

To avoid potential injury to the user and the patient and/or damage to this device, please note the following warnings:

1. Failure to follow instructions in this manual may lead to injury or damage to the equipment. Read this operating manual thoroughly, especially the warnings and cautions, and be familiar with its contents before connecting and using this equipment.
2. This equipment is designed for use by a qualified physician, having complete knowledge of the use of this equipment and the procedure to be performed. This device should only be used in compliance with the stated indications for use.
3. This equipment should be installed and tested prior to use. Before each use, inspect the equipment for signs of damage due to reprocessing or other handling and ensure the equipment is suitable for use. A pre-operative check should be performed prior to administration of patient anesthesia to ensure all desired functions are operational and that a viable surgical image is being displayed on the surgical monitor and there are no signs of damage to the equipment. Before each use or after a change in viewing modes/settings, the operator should check to ensure the view observed through the endoscope provides a live image (rather than a stored one) of proper color and size and has the correct image orientation.
4. For the protection of the patient, it is required to have a back-up system ready for use in the event of primary equipment failure.
5. This equipment may present a risk of electric shock. To reduce this risk, this equipment must only be connected to a supply mains with protective earth.
6. This equipment presents a risk of burns and fire. The internal LED light source generates high temperatures and high energy radiated light may be transmitted from the light emission window of the endoscope, giving rise to high temperatures in front of the light emission window. Thermal damage to the patient's tissue (for example, permanent tissue damage or coagulation) may result from prolonged exposure to intense illumination in small cavities or if the endoscope tip is placed in close proximity to tissue. To reduce the risk of burns and fire, avoid contacting the light guide connections and endoscope tip to skin or flammable materials (and other equipment) when these accessories are used. Always place the light source on Standby (no illumination) when the endoscope is removed from the body and not being used. Allow the endoscope and light cable and couplings to cool prior to detaching couplings. The camera head, during normal use, may generate surface temperatures in excess of 41 °C.
7. This equipment presents a risk of producing temporary blindness and eye damage. The internal LED light source is capable of generating intense direct light. To reduce this risk, never look directly at the light source output or the light source tip or endoscope when in use and direct the light away from the operator, patient, and bystanders eyes.
8. Loss of power to the equipment may result in a risk to the patient. An uninterruptable power supply is recommended.
9. Before each use, check the outer surface of this equipment to be used to ensure that there are no rough surfaces, sharp edges, or protrusions that can cause injury.

10. This device complies with the IEC 60601-1 safety standard. When peripherals are connected to this device, a Medical Electrical (ME) System is formed and the system should be evaluated for conformance to IEC 60601-1 standards. When used with other equipment, the leakage currents may be additive. The person creating the ME system is responsible to comply with the applicable safety regulations and safety standards for their location. Never touch peripheral equipment connections on this device and the patient at the same time, this can create a risk of shock to the patient.



Cautions

To prevent improper use and/or damage to this device, either of which could potentially result in injury to the patient or user, please note the following cautions:

1. Carefully unpack this unit and check if any damage occurred during shipment. If damage is detected, refer to the Warranty and Return Policy section of this manual.
2. This equipment is intended for use in a medical facility except for areas of high electromagnetic disturbance such as near Magnetic Resonance Imaging (MRI) equipment.
3. This equipment is not intended for use in an oxygen rich environment. Do not use the equipment in the presence of flammable liquids, gases or other materials susceptible to ignition.
4. This equipment generates heat and cooling fans operate during normal use. Always set up the console in a location that allows adequate ventilation (airflow) to the console. Insufficient ventilation may cause the console to overheat and shut down or create a risk of equipment damage or fire. Always set up the console to position the appliance inlet (where the power cord is attached to the equipment) so that it is readily accessible. Ensure that the equipment is operated in the stated operating conditions as specified herein.
5. Omni[®] Cameras may only be used with a compatible Omni[®] Console and manufacturer's specified accessories and peripheral equipment. Use with other non-approved equipment may create a risk of electrical shock, damage the device, degrade safety and/or cause loss of function. There is no guarantee that instruments selected solely on the stated maximum insertion portion width and working length will be compatible in combination.
6. In the case of equipment failure, this equipment may draw excessive power from the supply circuit and interrupt service to other equipment powered by the same circuit. To reduce this risk, this equipment should not share an electric outlet or grounding with life support or life sustaining equipment.
7. To reduce the risk of harm resulting from fire or interruption of mains circuit, use only the provided medical grade power cord and replacement fuses specified by the manufacturer. Follow the instructions provided herein and always remove power from the device prior to inspection or replacement of fuses.
8. Avoid dropping the camera system or rough handling. The camera system contains precisely aligned optical components and other sensitive components prone to damage by mechanical shock.
9. The endoscope tube can be bent or broken if leveraged against bone or other anatomy. Use a compatible cannula to minimize this risk. Do not use the camera as a lever. Do not excessively bend or kink the Omni[®] Handpiece cable.
10. The camera tip contains optics and may be damaged by surgical instruments. Avoid contact with surgical tools and other mechanical hazards. Use of surgical lasers can cause damage to the endoscope tip. Do not activate laser unless the laser delivery fiber is visible and pointed away from the endoscope.
11. There is a risk of equipment damage if the equipment is subjected to cleaning or sterilization methods not approved by the manufacturer. To reduce the risk of loss of function and/or damage to the equipment, only use the approved cleaning and sterilization methods described herein. Do not immerse the console in liquid.
12. There are no user serviceable parts inside the console or camera heads. There are hazardous voltages present inside the console, do not remove the cover. Return the device to the manufacturer for service.
13. If the device is connected to a network, ensure that the network is secure and appropriate preventative measures (for example, firewalls, network access authentication, malware detection software, etc.) are implemented to prevent device exposure to malware.
14. Where compliant with local radio law, this device may utilize an 802.11 ax/ac/a/b/g/n transceiver for wireless communication. These devices operate in the 2.4 and/or 5 GHz ISM bands. Locate the device away from other sources of RF energy in these frequency bands to reduce the chance of interference.

15. Before each use, the compatibility of the endoscopic equipment with any accessories and/or energized endotherapy devices should be checked according to any criteria for safe use defined in the instructions for use.
16. This equipment generates and radiates RF energy which may affect the normal function of nearby installed equipment. Equipment that generates and radiates RF energy may affect the normal function of the Omni® 4K HDR Video System. When choosing a location for the Omni® 4K HDR Video System, consult the "Electromagnetic Compatibility" section of this manual to ensure proper function with other installed equipment.
17. Use of this equipment adjacent to or stacked with other equipment should be avoided because it could result in improper operation. If such use is necessary, this equipment and the other equipment should be observed to verify that they are operating normally.
18. Portable RF communications equipment (including peripherals such as antenna cables and external antennas) should be used no closer than 30 cm (12 inches) to any part of the camera system, including cables specified by the manufacturer. Otherwise, degradation of the performance of this equipment could result.
19. Use of accessories, transducers and cables other than those specified or provided by the manufacturer of this equipment could result in increased electromagnetic emissions or decreased electromagnetic immunity of this equipment and result in improper operation.
20. Electromagnetic interference including emissions from High Frequency (HF) surgical devices (Radio Frequency (RF) or Electrosurgical Units (ESU) or similar terms) may cause irregular behavior and/or malfunction of the Camera System and may cause interference with or loss of the video image being displayed on the surgical monitor. To reduce the chance of interference, or if interference occurs, High Frequency consoles and cables should be located away from the Camera System and should be located on separate supply circuits to reduce disturbances. Do not activate HF unless the active electrode is visible and not touching the endoscope.



The warranty shall be considered void if any of these warnings or cautions are disregarded.

























Report any serious event, as defined in the European Medical Device Regulations (EU MDR 2017/745) or local legislation, involving the device to the manufacturer and, if applicable, to the national Competent Authority of the Member State or local jurisdiction.

















Federal law (United States of America) restricts this device to use by, or on the order of, a physician.

Symbol Definitions

In addition to the cautionary symbols already listed, other symbols found on the Omni® 4K HDR Video System and in this manual have specific meanings that clarify the proper use and storage of the Omni® 4K HDR Video System. The following list defines the symbols associated with this product:

Symbol	Definition	Symbol	Definition
	Caution - precaution or warning notice		Operating Instructions
	Keep dry		Humidity range
	This Side Up		Pressure range
	Fragile		Temperature range
	Manufacturer		Serial Number
	Date of Manufacture		Reference or Catalog Number
	Importer		Distributor
	Medical Device		Quantity
	Available by Prescription Only		Power Standby/On
	Light Source		Universal Serial Bus
	Video Camera		Fuse rating

Symbol	Definition	Symbol	Definition
	A lightning bolt within a triangle is intended to warn of the presence of hazardous voltage. Refer all service to authorized personnel.		Non-ionizing Radio Frequency Electromagnetic Radiation
	Type BF Equipment		Equipotentiality
	Magnetic Resonance Imaging Unsafe		Protective Ground Earth
	This symbol indicates that the waste of electrical and electronic equipment must not be disposed as unsorted municipal waste and must be collected separately. Please contact the manufacturer or other authorized disposal company to decommission your equipment.		Non-Sterile
			Do not use if package is damaged
			Underwriters Laboratories Safety Mark
	CE Mark		Regulatory Compliance Mark (Australia)
	Authorized Representative in the European Community		Authorized Representative in Switzerland

Product Description

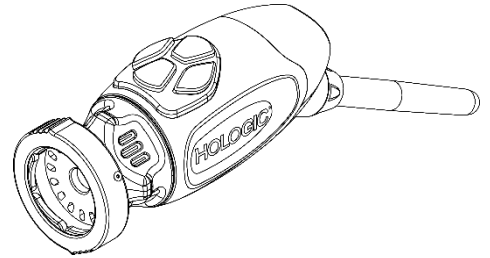
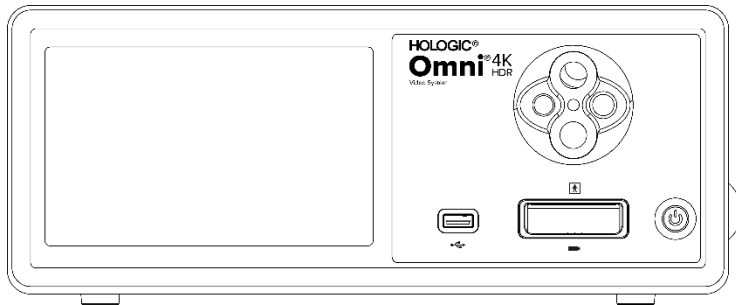

The Omni® 4K HDR Video System is an Ultra High-Definition camera system used to display live video, capture still images, and record video of endoscopic or general surgical applications. The system incorporates an internal light source featuring a Turret Light Guide Adapter which accepts various light guides. The Omni® Camera Heads (or Handpieces) utilize high-resolution camera sensors and provide distal LED illumination to the surgical site. The camera has buttons that can be programmed using the Omni® Camera Control Unit (CCU or “Console”) to serve various functions such as image and video capture.

The Omni® Handpiece is designed specifically for use with the Omni® Console and together form the Omni® 4K HDR Video System. The Omni® 4K HDR Video System consists of a console and a camera head from the list below:

Part Number	Component
83-10-5001	OMNI® 4K HDR SYSTEM, CAMERA CONTROL UNTIL WITH IMAGE CAPTURE & LIGHT ENGINE
83-10-5120	OMNI® 4K HDR SYSTEM, CAMERA HEAD, INTEGRATED, 1CMOS
83-10-1500	OMNI® 4K HDR SYSTEM, TABLET
83-10-1500T	OMNI® 4K HDR SYSTEM, TABLET, TETHERED

The Omni® 4K HDR Video System has been validated for use with various peripherals and connection cables which can be purchased separately.

Intended Use/Intended Purpose

The Omni® 4K HDR Video System, with integrated LED light source and image/video capture, is intended to be used when performing a variety of minimally invasive surgical procedures and for general medical visualization and video archive applications. The Omni® 4K HDR Video System incorporates a remote camera head which transmits the image, as presented through an endoscope, microscope, integrated or coupled optics, onto a viewing monitor. Displayed images and videos may be captured and stored internally and/or transmitted externally via a variety of means, controlled through the device's integrated touch panel or an optional secondary remote control mobile device.

The Omni® 4K HDR Video System is intended to be used in a controlled operating room environment with compatible devices by qualified medical personnel. The camera heads are provided non-sterile. The endoscopic camera head may be sterilized by steam autoclave or other prescribed sterilization methods. The system has a 3 year expected service life.

Indications/Contraindications

The Omni® 4K HDR Video System is indicated for use in diagnostic and operative endoscopic procedures to provide illumination and visualization of an interior cavity of the body through either a natural or surgical opening. The Omni® 4K HDR Video System is indicated for use with a compatible camera head and other accessory devices including an endoscope, optical coupler, and light cable.

There are no known contraindications.

The Camera Console

The camera console or Camera Control Unit (CCU) is the control center for the Omni® 4K HDR Video System and processes the live video and still images captured during the surgical procedure. The console front panel features a touch screen, where user menus can be accessed, including the camera controls for adjusting the enhancement level, light level, zoom, and white balance, as well as allowing the selection of camera profile settings that optimize camera performance for various, specific surgical procedures.

Front Panel

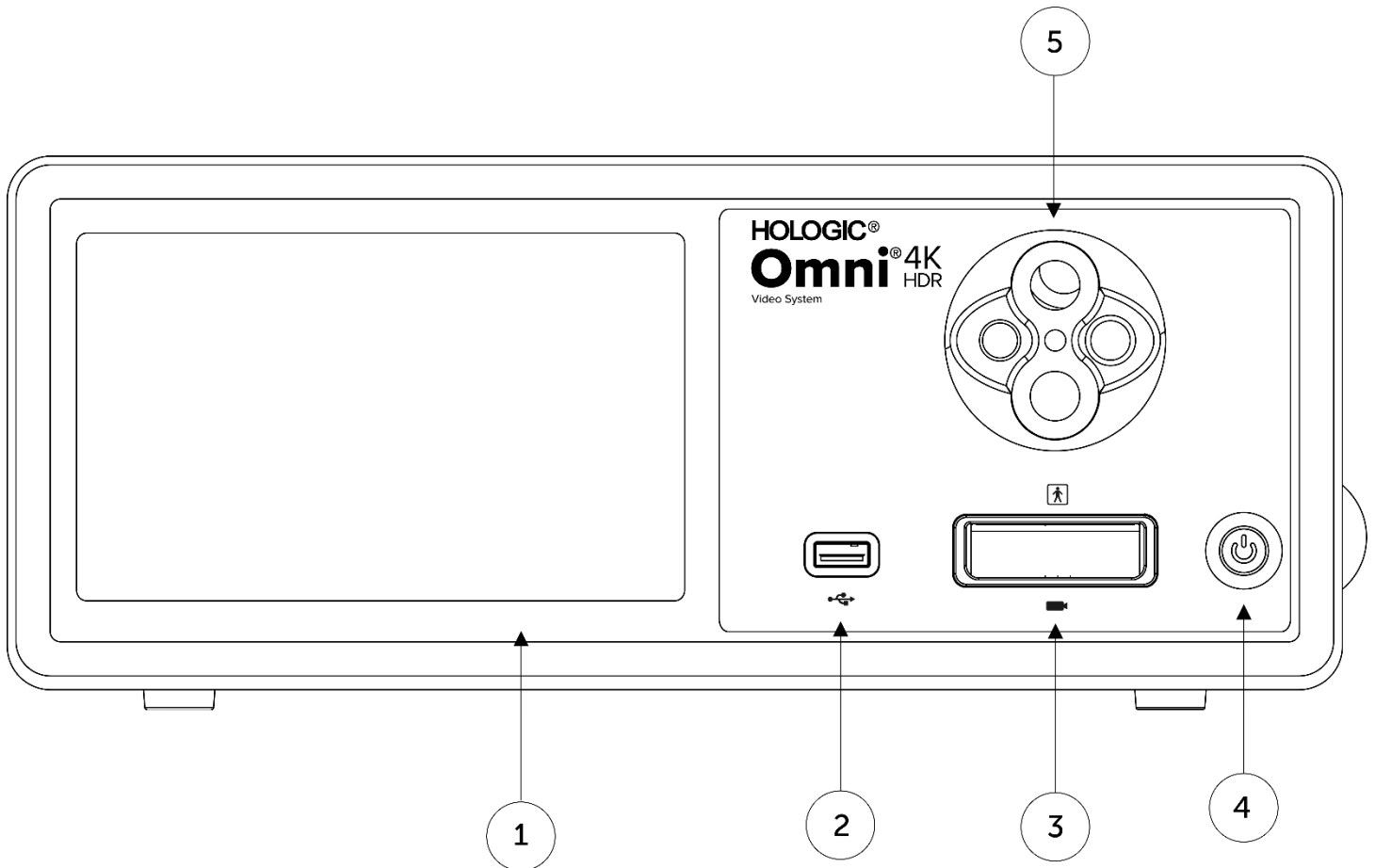

- | | | |
|----|-----------------------------------|--|
| 1. | Touch Screen | Allows navigation through different menus for controlling the camera and adjusting the system settings |
| 2. | USB Port | Allows for saving videos and still images to a USB device |
| 3. | Camera Connector Port | Connects to a remote camera head |
| 4. | Power Switch | Camera ON or STANDBY switch |
| 5. | Turret Light Guide Adapter | Accepts a variety of light guide adapters |

Rear Panel

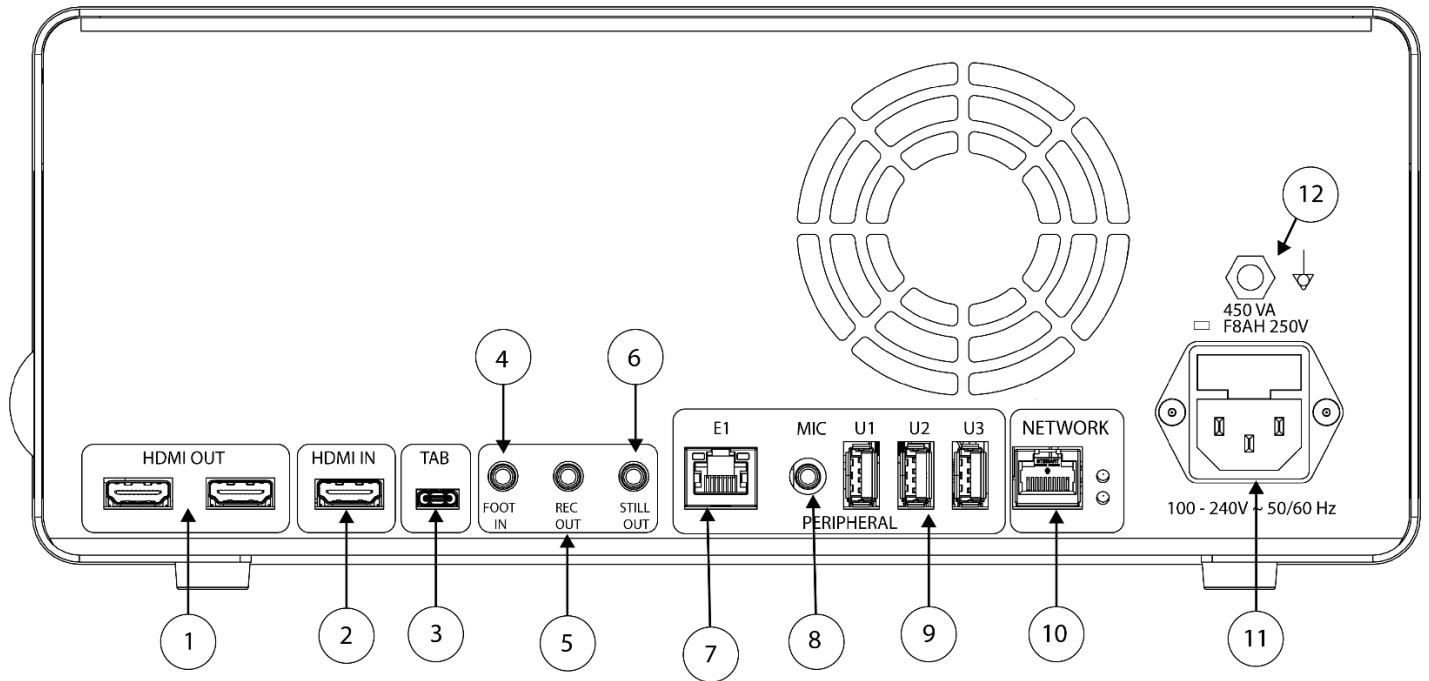

Rear Panel Diagram

- | | | |
|-----|----------------------------------|--|
| 1. | HDMI Out | 4K (UHD) HDMI video outputs (x2) |
| 2. | HDMI In | Digital video input |
| 3. | Tablet | Connects to the accessory tablet |
| 4. | Foot In | Connects to accessory remote footswitch |
| 5. | Rec Out | Connects to video recording device control input |
| 6. | Still Out | Connects to still image capture control input |
| 7. | E1 | Compatible peripheral expansion port |
| 8. | Mic In | Connects to accessory microphone |
| 9. | USB 3.0 Ports | Connects to accessories via USB 3.0 Ports (x3) |
| 10. | Network | Connects to a network via a high speed Ethernet connection |
| 11. | AC Power Inlet | Connects to separable power cord, to connect to supply mains |
| 12. | Equipotential Ground Plug | Connects to system or chassis ground |

The Camera Head

The camera head connects to the camera console and captures video and still images, which it relays to the camera console.



Warning: The camera head is not an Applied Part and is not intended for patient contact.

All camera heads utilize a cable connector to connect to the camera console. Insert or remove the camera cable by using the cable connector. Do not pull on the cable to attempt to disconnect the connector.

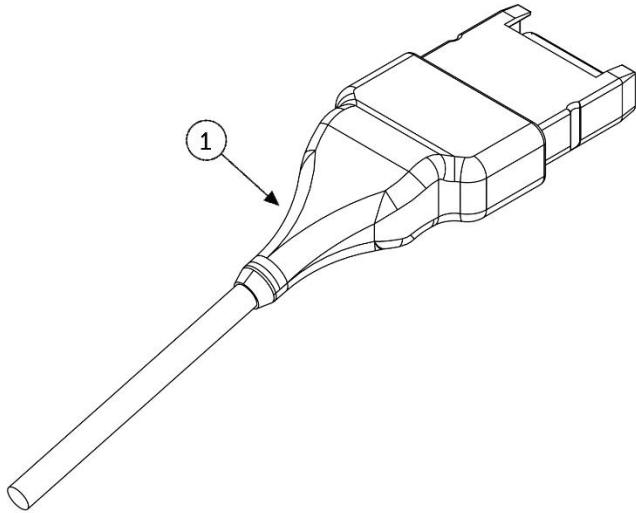

- | | |
|---------------------------|--|
| 1. Cable Connector | Connects the camera head to the camera console |
|---------------------------|--|

Integrated Camera Head (83-10-5120)

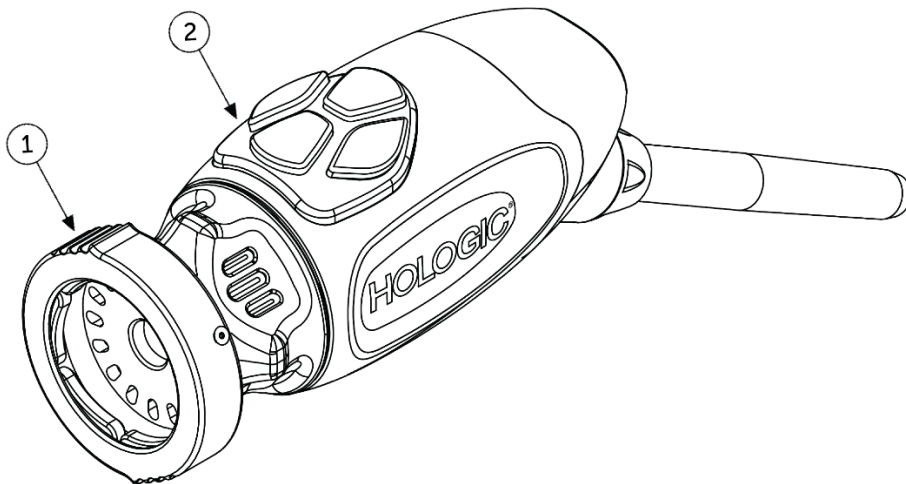

- | | |
|------------------------|---|
| 1. Grabber | Accepts a compatible endoscope |
| 2. Head Buttons | Four programmable buttons that can activate various functions of the camera |

Compatible Equipment

The Omni® 4K HDR Video System has been validated for compatibility with the following equipment:

<u>Catalog Number</u>	<u>Description</u>
83-12-2703	4K MONITOR, HDR, 27 INCH
83-12-3203	4K MONITOR, HDR, 32 INCH
83-12-3204	4K MONITOR, HDR, 32 INCH, SONY
83-18-1004	CAMERA HEAD TRAY, HOLOGIC
83-20-5003	5MM LIGHT GUIDE, BLUE, HOLOGIC
83-20-50031	WOLF LIGHT GUIDE POST ADAPTER, HOLOGIC
83-20-50032	ACMI LIGHT GUIDE POST ADAPTER, HOLOGIC
83-20-50033	STORZ LIGHT GUIDE POST ADAPTER, HOLOGIC
83-26-1500	OMNI 4K HDR SYSTEM, TABLET TETHER CABLE
83-26-5001	OMNI 4K HDR SYSTEM, ASSY, PACKAGED, VIDEO ACCESSORY, HDMI CABLE, 25FT
83-26-5000	OMNI 4K HDR SYSTEM, ASSY, PACKAGED, VIDEO ACCESSORY, HDMI CABLE, 6FT
83-26-9010	US POWER CORD, HOLOGIC
UPDR80MD	MEDICAL PRINTER SONY
UPCR81MD	COLOR PRINT PACK SONY
UPCR80MD	A4 COLOR PRINT PACK SONY
FS-24	FOOTSWITCH SONY FS-24
85-26-4001	USB FLASH DRIVE

Setup and Interconnection

Note: Instructional training, or inservice, is an integral part of the Omni® 4K HDR Video System. Your local sales representative will perform at least one inservice at your convenience to help set up your equipment and instruct you and your staff on its operation and maintenance. To schedule an inservice, contact your local sales representative after your equipment has arrived.

Setting up the Omni® 4K HDR Video System involves three steps:

1. Setting up the console & monitor
2. Setting up the camera head with illumination, if applicable
3. Setting up the compatible accessories, if applicable

A typical installation is illustrated in Figure 1 for reference.

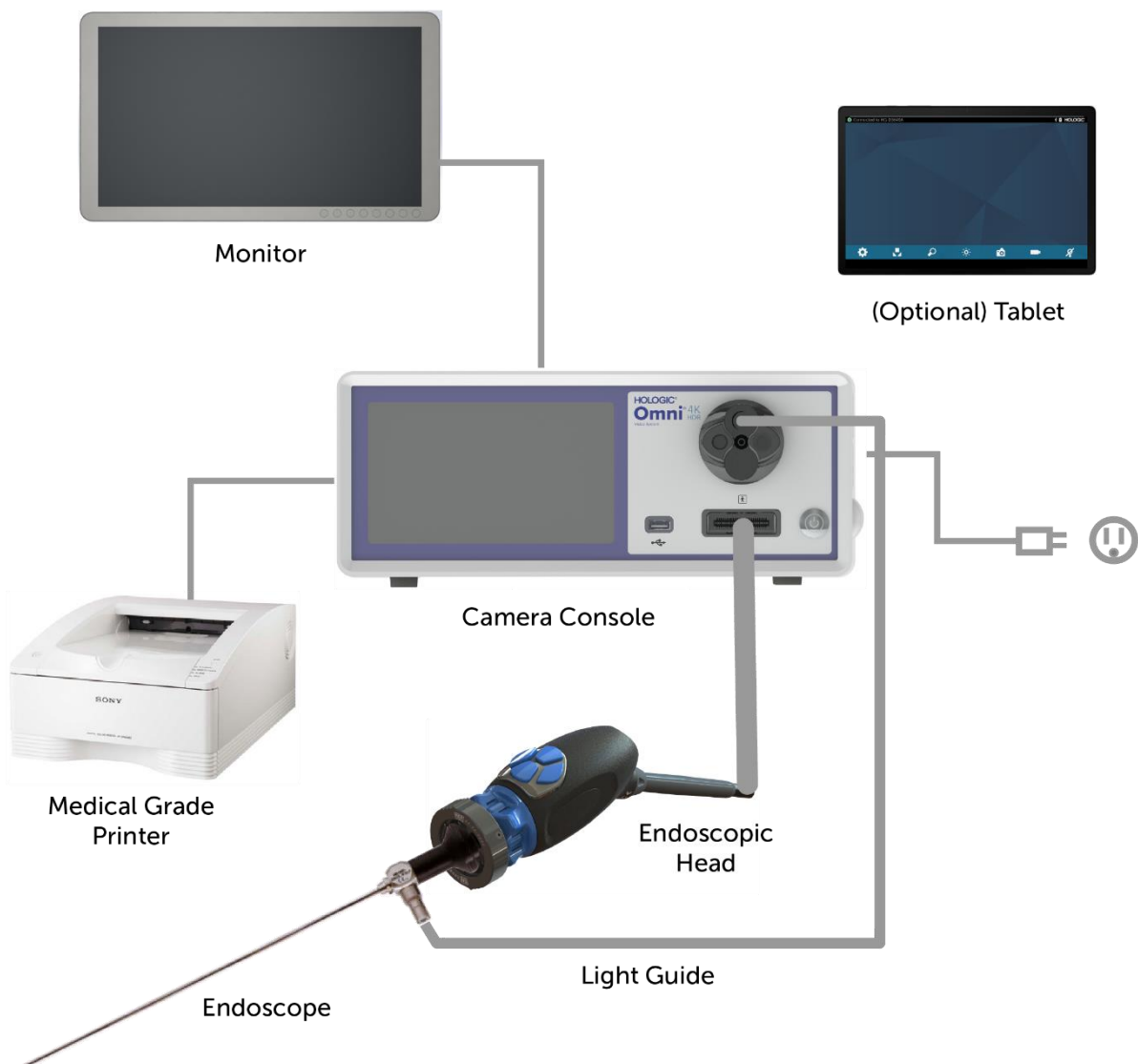

Figure 1 – Installation/System Setup Illustration

Setting Up the Console & Monitor

1. Inspect equipment for damage prior to use. Do not use if damaged.
2. Place the Omni® Console in a well-ventilated location (video cart shelf, etc).
3. Setup compatible monitor per the manufacturer's specifications. Only IEC60601-1 approved monitors are allowed to be connected to the camera system.
4. Connect the video output.
5. Connect a HDMI video cable to the HDMI output on the rear panel of the Omni® Console.
6. Connect the other end of the HDMI cable to the HDMI input of the monitor.
7. Connect the AC power cord.
8. Plug the AC power cord into the power inlet module on the rear panel of the Omni® Console.
9. Connect the other end to a grounded outlet (100-240 V~, 50-60Hz).
10. Ensure that the console is located and positioned so that the appliance inlet (where the power cord is connected to the equipment) is readily accessible.
11. After AC power is applied and the unit is powered ON, ensure a color bar pattern appears on the monitor. A live image will only be displayed when a camera head is connected to the console.
12. Upon initial installation and setup, an installation wizard will appear on the console display. Select preferred language and country from selection menu on console.
13. Review camera settings and profiles. Make any changes as needed via the console or tablet menu as required.

NOTE: An additional monitor may be connected to the other HDMI video output on the rear panel.

Setting Up the Camera Head (83-10-5120)

1. The Omni® Camera Head may only be used with a compatible Omni® Console.
2. Where sterilization is required, the camera head should be cleaned and sterilized prior to each use per the instructions herein. Inspect the camera head and connector for any signs of damage or degradation prior to each use. Do not use if damaged.
3. Insert the camera head connector into the camera receptacle on the front panel of the console. Alignment features are provided on the camera head connector to ensure proper orientation.

NOTE: Ensure the camera head connector contacts are clean and dry prior to insertion.

Setting Up the Light Source (applicable for 83-10-5001)



WARNING

IMPORTANT SAFETY NOTICE:

When using a light source, fire and/or injury may result to the patient, user, or inanimate objects. Light sources generate significant amounts of heat at the endoscope tip, the endoscope light post, the light cable tip, and/ or near the light cable adapter. Maintain the light source at a minimum as higher levels of brightness from a light source may result in higher levels of heat.

To reduce the risk of injury, avoid patient and user contact with the endoscope tip or light cable tip, and never place them on top of the patient, as doing so may result in burns to the patient or user.

To reduce the risk of fire, never place the endoscope tip, the endoscope light post, the light cable adapter, or the light cable tip on the surgical drapes or other flammable material, as doing so may result in fire.

Always place the light source in standby mode whenever the endoscope is detached from the light cable or the device is unattended. The endoscope tip, endoscope light post, light cable adapter, and light cable tip will take several minutes to cool off after being placed in standby mode, and therefore may still present a hazardous condition to the patient, user, or inanimate objects.

To use the internal light source:

1. Identify the desired light guide receptacle and ensure it is set to the top position.
2. Insert the light guide cable into the light guide receptacle on the front panel of the console.
3. Attach the other end of the light guide cable to the endoscope.
4. Attach the endoscope to the camera head grasping mechanism.
5. Press the Light Source On/Standby Switch to ON to activate LED light engine.

NOTE: If there is no Light Guide cable connected to the Omni® Console, pressing the On/Standby button will not activate the LED light engine until one is connected.

NOTE: If using 83-10-5001 with an external light source, please refer to the corresponding light source user manual.

Setting Up the Compatible Equipment

Connect other compatible accessories and peripheral equipment, as applicable.

- Use Figure 1 and the rear panel labeling as a guide to connect other compatible equipment, if desired.
- Connect only IEC60601-1 approved equipment.
- The device is compatible with HL7-based Electronic Health Record (EHR) and Electronic Medical Record (EMR) systems that support a DICOM translation layer. Please contact your sales representative who can assist with additional information and pre-installation guidance.

System Operation



WARNING: For the protection of the patient, perform a complete system test prior to initiating a surgical procedure.

Pre-Operative Check

For the protection of the patient, it is essential that the system setup is complete, functional, and produces a viable image on the surgical monitor prior to administration of patient anesthesia or starting a case. Pre-operative checks should include functionality of peripheral equipment, optical accessories, and illumination. For the protection of the patient, it is required to have a back-up system ready for use in the event of primary equipment failure.

After plugging in the Omni® Camera Head connector into the console, the image on the monitor should turn from a color bar pattern to live video. Turn on the LED illumination by pressing the Light Source Standby icon on the home screen of the console.



Before use, check that the light source activates standby mode (light source is turned off) upon removal of light guide.



Before each use, the operator should check to ensure that essential camera controls are functioning as needed for the intended procedure. During use, after changing camera system settings or initiating image or video capture, the operator should check that the image displayed is live, of proper color and size, and properly oriented.

White Balance

When the camera head connector is inserted, the User is required to white balance the camera. Pressing any of the four head buttons activates the white-balance function. The white balance function is used to correct slight color differences that exist between different light sources or endoscopes.

Perform the white balance procedure before every surgical procedure.

Note: Ensure that an endoscope and light source are attached to the camera, and that the camera, light source and monitor are powered on before adjusting the white balance

1. Ensure the White Balance function is initiated as indicated by the White Balance Indicator on the video monitor. 
2. Point the endoscope at several stacked 4"x4" (10cm x 10cm) white gauze pads, a white laparoscopic sponge, or any clean white surface.
3. Look at the monitor and make sure that no glare is visible off of the white surface.
4. Press any reusable camera head button until the White Balance indicator is displayed on the video monitor. 
5. Continue pointing the endoscope at the white surface until the video monitor indicates that white balance process is complete. The video picture may change color. If you cannot achieve an acceptable white balance, refer to the "Troubleshooting" section of this manual. 
6. After white balance has been achieved, all reusable head buttons revert to their standard functions (which may be configured using the Profile submenu of the Settings Menu).
7. White balance may also be initiated from the Console front panel or via the tablet.

Using the Console Touchscreen Interface

The touchscreen interface on the console provides controls for operating the camera and selecting system settings. Controls and Settings Menu described below.*

* UI illustrations are provided for content reference only. Variations in appearance may occur.

Console Home Screen

The Home screen is the default screen.

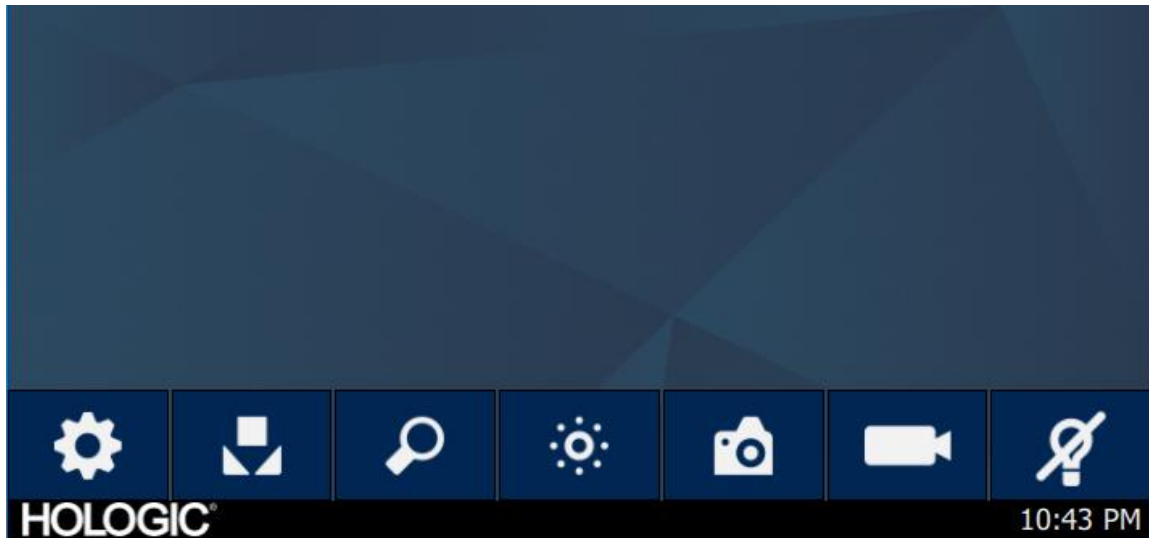

Console Home Screen Toolbar

The Toolbar provides options for frequently used camera functions or console Settings access.

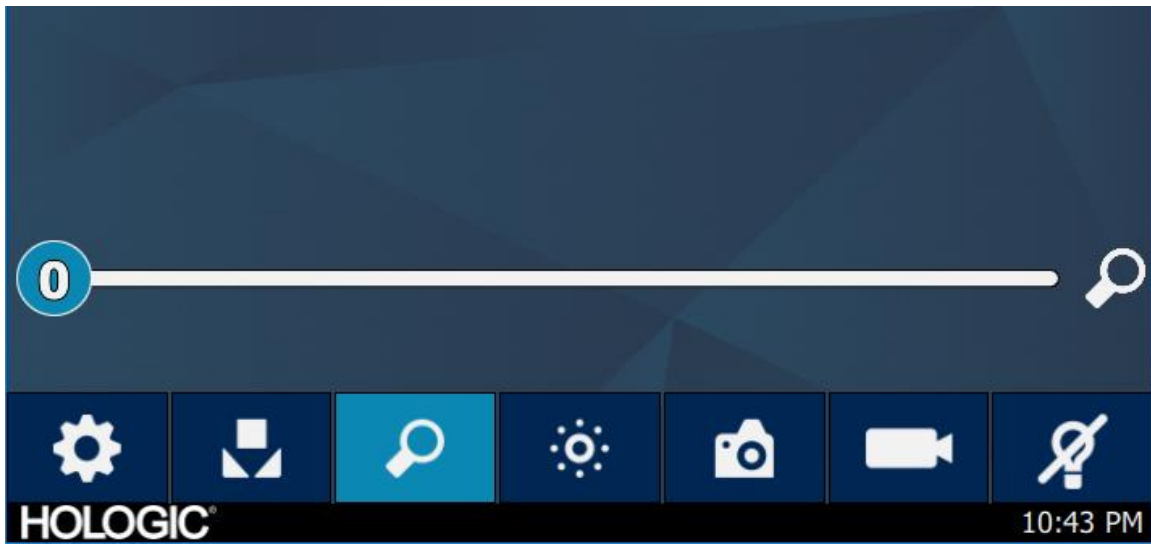

Console Functions

Settings Menu



White Balance



Zoom



Brightness



Still Image Capture



Video Record



Light Source Standby



Console Settings

The Settings Menu provides options for setting the camera profile, scheduling work, and other camera system settings.

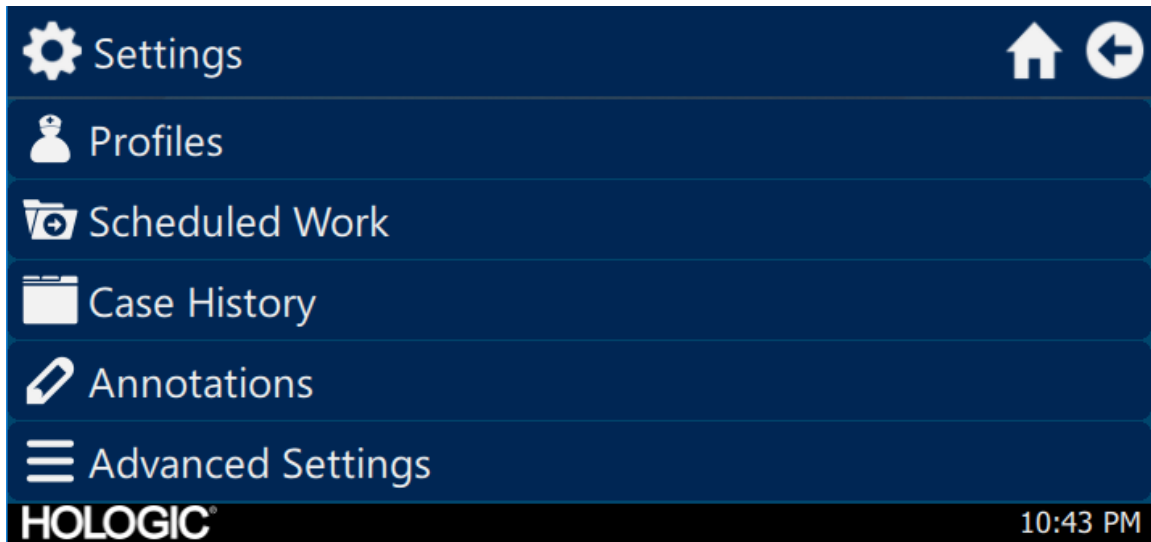

Profiles

The Profile Menu provides options for selecting a camera profile.

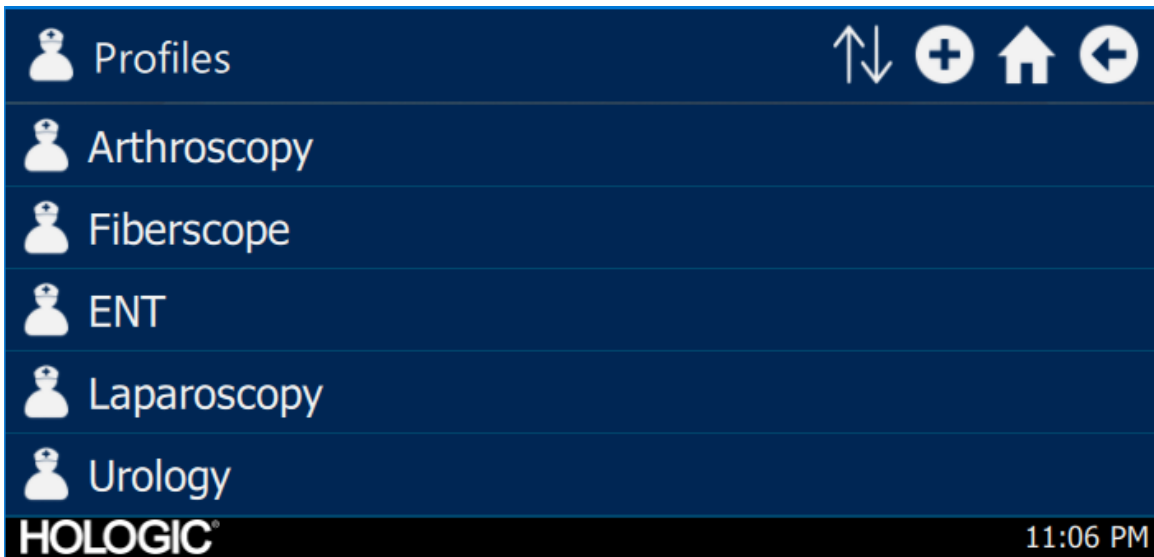

Scheduled Work

Access new or scheduled case data in the Scheduled Work menu. Patient information and other important data may be entered for a case. A new case may be started immediately or saved for a later start time. In order to start a new case, users are required to enter a minimum of information as configured in the Menu settings.

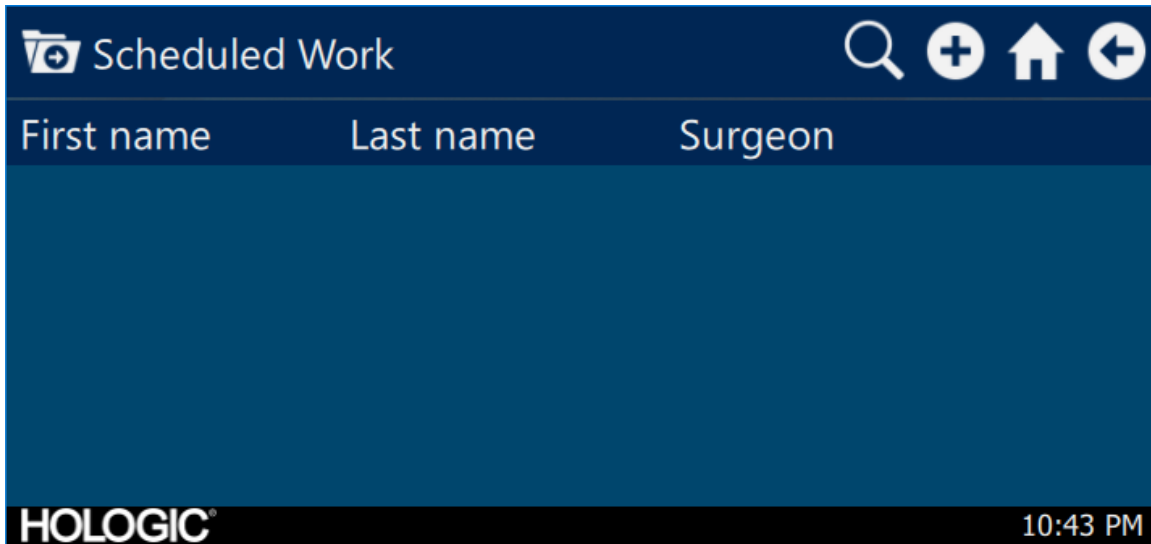

The screenshot shows the 'Scheduled Work' menu. At the top, there is a dark blue header with a folder icon and the text 'Scheduled Work'. To the right of the header are four icons: a magnifying glass, a plus sign, a house, and a left-pointing arrow. Below the header is a table with three columns: 'First name', 'Last name', and 'Surgeon'. The table body is currently empty. At the bottom of the screen, there is a black bar with the 'HOLOGIC' logo on the left and the time '10:43 PM' on the right.

New Case Entry

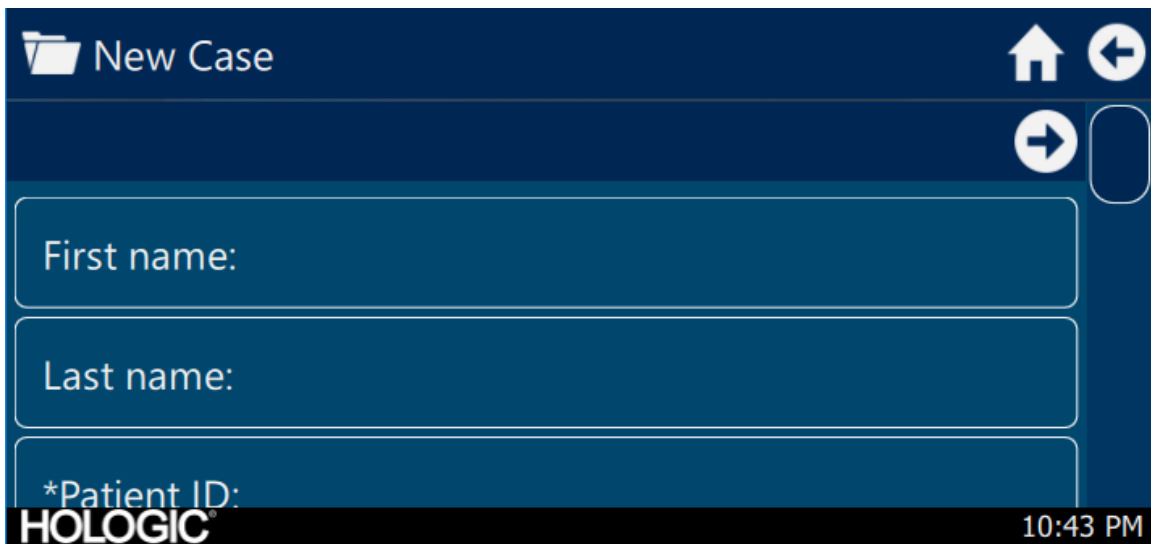

The screenshot shows the 'New Case' entry form. At the top, there is a dark blue header with a folder icon and the text 'New Case'. To the right of the header are three icons: a house, a right-pointing arrow, and a left-pointing arrow. Below the header are three input fields: 'First name:', 'Last name:', and '*Patient ID:'. The '*Patient ID:' field has a small asterisk indicating it is required. At the bottom of the screen, there is a black bar with the 'HOLOGIC' logo on the left and the time '10:43 PM' on the right.

Console Start Case

New Case

Start case?

First name

Last name

*Patient ID:

HOLOGIC

10:43 PM

Using the Tablet Interface

The tablet provides an additional interface for image and video capture functionality and for adjusting system settings.

Tablet screens and menu selections are equivalent to the Console Touchscreen Interface.

Tablet Set Up

The tablet may be set up for wireless* or tethered (cabled, non-wireless) connection to the console. For wireless use*, ensure that the tablet's Wi-Fi is turned on and connected to the console's wireless network. For tethered operation, the console's Wi-Fi may be turned off and the tablet should be connected directly to the console using the supplied Tablet Tether Cable. The tablet manufacturer's charging cable is only used for charging the tablet from a wall outlet.

* Wireless functionality is only allowed in approved regions where such functionality is compliant with local radio law.

Tablet Home Screen & Toolbar

The Home screen is the default screen. The Toolbar provides options for frequently used camera functions or console menu access. Camera controls and menu options are equivalent to the console touchscreen interface.

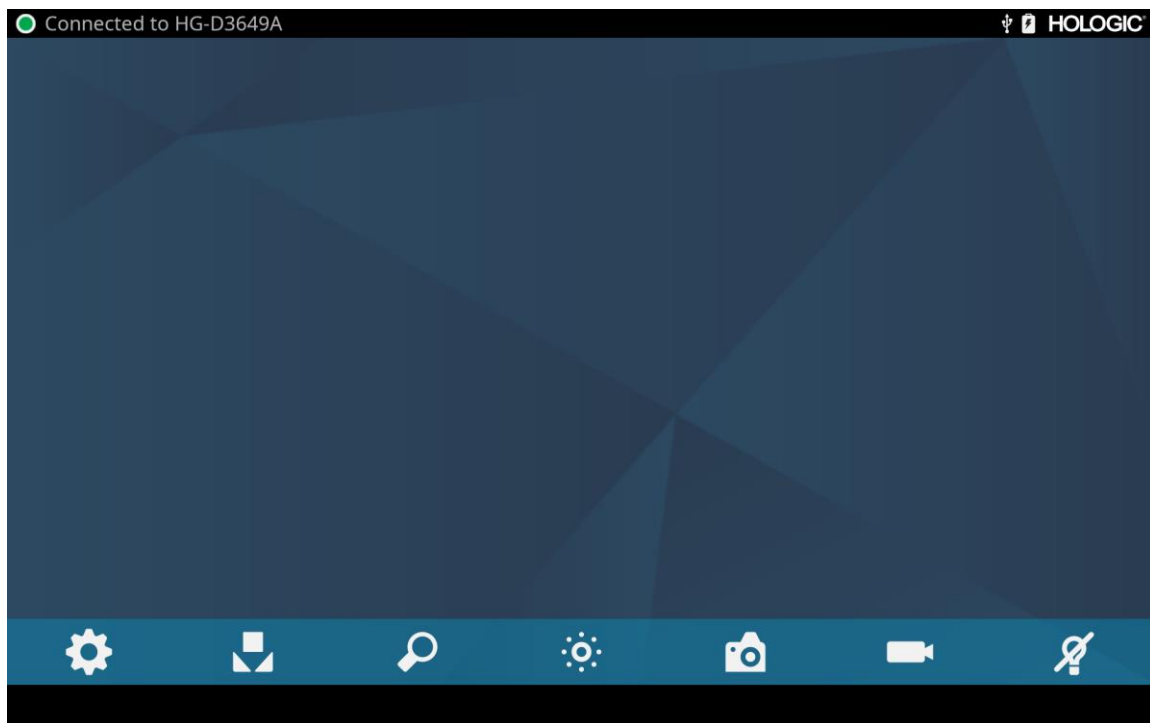

Troubleshooting

Problem	Possible Solution
No color bars present during set up	<ul style="list-style-type: none"> • Ensure the video-out from the console is connected to the video-in on the monitor. • Ensure all video systems are powered on. • Ensure that the camera head is not connected to the console. • Turn off the console, wait 3 seconds, and turn it back on.
Incorrect picture color	<ul style="list-style-type: none"> • Perform the white balance procedure. (See the “White Balance” section of this manual) • Check the color settings on the monitor.
White balance (WB) quality not good	<ul style="list-style-type: none"> • See the solution for “Picture is too dark.” • See the solution for “Picture is too bright.” • Perform the white-balance procedure with the light source connected to the endoscope. Use the device’s LED light source or a separate xenon light source (no fluorescent lighting).
Picture is too dark	<ul style="list-style-type: none"> • Increase the camera brightness. • Check the fiber-optic light cable for excessive broken fibers. • Check the endoscope for damage.
Picture is too bright	<ul style="list-style-type: none"> • Decrease the camera brightness.
Noise or snow on picture when using High Frequency (HF) surgical devices	<ul style="list-style-type: none"> • Plug any HF surgical devices into a separate electrical outlet and separate the Omni® Video System power cord from the HF surgical devices. • Separate the camera cable from the HF surgical device cable. • Reposition the HF surgical device grounding pad on the patient.
Noise or snow on picture when not using High Frequency (HF) surgical devices	<ul style="list-style-type: none"> • Reduce Enhancement. • Check for and replace faulty video cables.
No video picture when the camera head is plugged in	<ul style="list-style-type: none"> • Check to ensure that all devices in the video system are plugged in and powered on. • Check the connector on the camera head cable for damaged contacts. • Detach the camera head from console and reconnect. • Turn off the console, wait 3 seconds, and turn it back on.
Image is not well centered	<ul style="list-style-type: none"> • Release the endoscope from the coupler and then reconnect it. Make sure the endoscope is seated correctly in the coupler.
Foggy picture (loss of definition and clarity)	<ul style="list-style-type: none"> • Refocus the camera. • Refocus the coupler. • Clean and dry the camera, endoscope, and coupler windows.

Problem	Possible Solution
Optics are dirty	<ul style="list-style-type: none"> • Rotate the endoscope. If dust particles in the picture rotate, the dust is located on the endoscope itself. Follow the manufacturer's instructions for cleaning the eyepiece and negative lens. • If particles in the picture do not move when you rotate the endoscope, the particles are located on the coupler or camera. Remove the endoscope and clean the windows on the coupler and camera with a dry or alcohol-tipped cotton swab. • Ensure all components are completely dry before reassembling them, or fogging may result.
Blurry picture	<ul style="list-style-type: none"> • Ensure the coupler or camera is in focus. • Increase the enhancement.

Note: If this troubleshooting guide does not resolve the problem, contact Hologic Technical Support (1-800-442-9892 or GssTechSupport2@hologic.com). Refer to the "Warranty, Service, and Repair" section of this manual.

Cleaning, Reprocessing, and Maintenance

The console may be cleaned, but not sterilized.

The endoscopic camera heads and couplers may be cleaned and sterilized. See instructions provided below.

Cleaning the Console

Disconnect the console from the AC power source before cleaning.



CAUTION: Never immerse or sterilize the console as this will damage the console and void the warranty.

Should the console need cleaning, wipe it down with a sterile cloth and mild cleaning solution.

Reprocessing the Camera Head



CAUTION: Only camera heads marked Autoclave can withstand steam sterilization. Autoclaving camera heads that do not bear this marking will result in product damage.

NOTE: Camera heads marked Autoclave are materially compatible with CIDEX™ OPA Solution.

Autoclave

Manufacturer: Santa Barbara Imaging Systems

Method: Steam Sterilization (Autoclave)

Device: Omni® 4K HDR Video System Camera Heads marked Autoclave, Wrapped

Warnings



- This device is provided nonsterile and must be cleaned and sterilized prior to the first use when a sterile device is required. Clean and sterilize this device prior to each subsequent use when a sterile device is required.
- Wear appropriate protective equipment: gloves, eye protection, etc.
- Use only the sterilization cycles outlined in this document. Using unspecified sterilization cycles may damage the device or result in incomplete sterilization resulting in patient risk.
- Separate the camera head and endoscope prior to cleaning, disinfection, or sterilization. If a C-mount camera is used, separate the coupler and endoscope prior to cleaning, disinfection, or sterilization. If the coupler and camera head are cleaned, disinfected, or sterilized as a single unit, disconnecting the coupler during use will compromise the sterility of the two products. (Refer to the coupler and endoscope product manuals for reprocessing instructions.)

Cautions

- Use only the approved cleaning procedure outlined herein. Use of other cleaning procedures, including cleaning agents and germicidals, not specified in this document may cause product damage.
- Inspect the camera cable for cuts and breaks before soaking in any fluid.
- Return any damaged camera to manufacturer for service.
- Never soak the camera in the same tray with sharp instruments.
- Do not use brushes or pads with metal or abrasive tips during manual cleaning, as permanent scoring or damage could result.
- To minimize galvanic corrosion, avoid soaking dissimilar metals in close proximity.
- Allow the camera head to cool before connecting it to the console.
- Connecting the camera head while it is still hot may result in system error.

Limitations on Reprocessing

- Do not cross-sterilize the device. Using multiple sterilization methods may significantly reduce the performance of the device.
- Do not leave the device in solutions longer than necessary. This may accelerate normal product aging.
- Proper processing has a minimal effect on this device. End of life is normally determined by wear and damage due to use.

Note: Damage incurred by improper processing will not be covered by the warranty.

Instructions																					
Point of use:	<ul style="list-style-type: none"> Wipe excess soil from the device using disposable paper towels. If an automated reprocessing method will be used, rinse any channels in the device with 1.7 oz (50 mL) of distilled water or reverse osmosis (RO) treated water, immediately after use. 																				
Containment and transportation:	<ul style="list-style-type: none"> Reprocess the device as soon as reasonably practical following use¹. Transport the device in a tray to avoid damage. 																				
Preparation for cleaning:	<ol style="list-style-type: none"> Separate the endoscope from the camera head. If a C-Mount camera head is being used, separate the coupler from the camera head. Prepare an enzymatic cleaning solution, such as Steris Prolystica 2X Concentrate Enzymatic Cleaner, according to the manufacturer's instructions. When using Steris Prolystica 2X Concentrate Enzymatic Cleaner we recommend 1/4 oz of cleaner per gallon (2 mL per Liter) of distilled or reverse osmosis (RO) treated water. Wipe the entire device with the cleaning solution using a clean cloth. Immerse the device in the cleaning solution. Using a syringe, inject any inside regions of the device with 1.7 oz (50 mL) of the detergent to ensure all parts of the device are reached. Soak the device in the detergent for a minimum of 15 minutes. 																				
Cleaning: Automated	<p>Equipment: Washer/Disinfector, detergent (such as Steris Prolystica 2X Concentrate Enzymatic Cleaner)</p> <p>Mechanical Washer Cycle Parameters:</p> <table border="1"> <thead> <tr> <th>Treatment</th> <th>Minimum Time (mm:ss)</th> <th>Minimum Temperature</th> <th>Cleaning Solution</th> </tr> </thead> <tbody> <tr> <td>Enzyme Wash</td> <td>04:00</td> <td>60° C</td> <td>Steris Prolystica 2X Concentrate Enzymatic Cleaner 1/4 oz. per gallon (2 mL per Liter)</td> </tr> <tr> <td>Wash</td> <td>02:00</td> <td>Hot Tap Water</td> <td>Steris Prolystica 2X Concentrate Neutral Detergent 1/4 oz. per gallon (2 mL per Liter)</td> </tr> <tr> <td>Rinse</td> <td>02:00</td> <td>70° C</td> <td>N/A</td> </tr> <tr> <td>Dry</td> <td>15:00</td> <td>80° C</td> <td>N/A</td> </tr> </tbody> </table>	Treatment	Minimum Time (mm:ss)	Minimum Temperature	Cleaning Solution	Enzyme Wash	04:00	60° C	Steris Prolystica 2X Concentrate Enzymatic Cleaner 1/4 oz. per gallon (2 mL per Liter)	Wash	02:00	Hot Tap Water	Steris Prolystica 2X Concentrate Neutral Detergent 1/4 oz. per gallon (2 mL per Liter)	Rinse	02:00	70° C	N/A	Dry	15:00	80° C	N/A
Treatment	Minimum Time (mm:ss)	Minimum Temperature	Cleaning Solution																		
Enzyme Wash	04:00	60° C	Steris Prolystica 2X Concentrate Enzymatic Cleaner 1/4 oz. per gallon (2 mL per Liter)																		
Wash	02:00	Hot Tap Water	Steris Prolystica 2X Concentrate Neutral Detergent 1/4 oz. per gallon (2 mL per Liter)																		
Rinse	02:00	70° C	N/A																		
Dry	15:00	80° C	N/A																		

¹ A 120 minute wait time was used during cleaning validation to simulate worst case conditions.

Instructions

Cleaning: Manual	<ol style="list-style-type: none">1. Brush<ul style="list-style-type: none">○ Prepare enzymatic cleaner (such as Steris Prolystica 2X Concentrate Enzymatic Cleaner) according to the manufacturer's instructions. When using Steris Prolystica 2X Concentrate Enzymatic Cleaner we recommend 1/4 oz of cleaner per gallon (2 mL per Liter) of distilled or reverse osmosis (RO) treated water.○ While immersed in the cleaning solution, thoroughly brush the exterior of the device with a soft-bristled brush, focusing on any mated or rough surfaces. Brush each device for one (1) minute. Brush all moveable parts in all extreme positions.○ Using a syringe, inject any mated surface with 1.7 oz (50 mL) of the cleaning solution a minimum of five (5) times.2. Rinse<ul style="list-style-type: none">○ Rinse the device, individually, with distilled or reverse osmosis (RO) treated water for one (1) minute to ensure all detergent residue is removed. Flush mated surfaces using a syringe five (5) times with 1.7 oz (50 mL). Continue to rinse each device, individually, for a minimum of 30 seconds.○ Drain excess water from the device and dry it using a clean cloth or pressurized air.○ Visually inspect the device for cleanliness, paying close attention to hard-to-reach areas. If visible soil remains, repeat steps 1 and 2.3. Soak<ul style="list-style-type: none">○ Prepare neutral detergent (such as Steris Prolystica 2X Concentrate Neutral Detergent) according to the manufacturer's instructions. When using Steris Prolystica 2X Neutral Detergent we recommend 1/4 oz per gallon (2 mL per Liter) with distilled or reverse osmosis (RO) treated water.○ Fully immerse the device and use a syringe to inject mated surfaces with 1.7 oz (50 mL) of the detergent solution.○ Soak the device for a minimum of 15 minutes.4. Brush<ul style="list-style-type: none">○ While immersed in the cleaning solution, thoroughly brush the exterior of the device using a soft-bristled brush for one (1) minute. Brush all moveable parts in all extreme positions.○ Using a syringe, inject 1.7 oz (50 mL) of the detergent into mated surfaces a minimum of five (5) times.5. Rinse<ul style="list-style-type: none">○ Rinse the device, individually, with distilled water or reverse osmosis (RO) treated water for one (1) minute to ensure all detergent residue is removed. Flush mated surfaces using a syringe five (5) times with 1.7 oz (50 mL). Continue to rinse each device, individually, for a minimum of 30 seconds.○ Drain excess water from the device and dry it using a clean cloth or pressurized air.○ Visually inspect the device for damage and cleanliness, paying close attention to hard-to-reach areas. If visible soil remains, repeat steps 4 and 5. Camera heads with damage to the camera head or cable jacket should not be sterilized and should be returned to manufacturer for repair.
Disinfection:	N/A
Drying:	See method described above in Mechanical or Manual cleaning section.

Instructions									
Maintenance:	No particular requirements.								
Inspection and Function Testing:	Inspect the device for any damage. If the camera head is damaged or the cable is cut or kinked or if the cable jacket has been cut or otherwise damaged, do not sterilize the camera head. Return camera heads with damage to manufacturer for repair.								
Packaging:	No particular requirements.								
Sterilization:	<table border="1" style="margin-left: 20px;"> <thead> <tr> <th colspan="2">Steam Pre-vacuum Parameters</th> </tr> </thead> <tbody> <tr> <td>Minimum Temperature</td> <td>132°C (270°F)</td> </tr> <tr> <td>Minimum Exposure Time</td> <td>4 minutes</td> </tr> <tr> <td>Dry Time</td> <td>30 minutes</td> </tr> </tbody> </table> <p>Note: After autoclaving, set unit aside for a minimum of 15 minutes to allow equipment to cool before connecting to the console or attaching an endoscope. Connecting the camera head while it is still hot may result in system error.</p>	Steam Pre-vacuum Parameters		Minimum Temperature	132°C (270°F)	Minimum Exposure Time	4 minutes	Dry Time	30 minutes
Steam Pre-vacuum Parameters									
Minimum Temperature	132°C (270°F)								
Minimum Exposure Time	4 minutes								
Dry Time	30 minutes								
Storage:	Never store the device in a non-ventilated, humid environment such as a carrying case. This may present an infection control risk.								
Additional Information:	Following the instructions prescribed above for cleaning and sterilization processes are validated to ensure a clean sterilized device. In addition to following the processes outlined above, it is recommended that the sterilization temperature does not exceed 135° (275°F) to avoid accelerating normal product aging.								
Contact:	See last page of this manual for local representative contact information.								



WARNING: While these reprocessing instructions have been validated by the manufacturer as being CAPABLE of preparing the device for re-use, it remains the responsibility of the processor to ensure that the reprocessing is actually performed, using equipment, materials, and personnel in the reprocessing facility, achieve the desired result. This normally requires validation and routine monitoring of the process. Likewise any deviation by the processor from the instructions provided should be properly evaluated for effectiveness and potential adverse consequences.

Sterrad®

NOTE: Only camera heads marked Autoclave are materially compatible with Sterrad. Omni® Camera Heads are validated for Sterilization Assurance using the Sterrad® Systems listed below.

- Sterrad® System 100S Short Cycle
- Sterrad® System NX Standard Cycle
- Sterrad® System 100NX™ Standard Cycle
- Sterrad® System 100NX™ Duo Cycle

Please consult the instructions provided by Sterrad for using STERRAD® 100S Short Cycle, NX™ Standard Cycle, or 100NX™ Standard and Duo Cycle Sterilization Systems.

If Sterrad sterilization is used, please note the following:

1. Clean and prepare the camera head and cable as recommended in the “Reprocessing the Camera Head” section.
2. Allow the camera head, cable, coupler, and endoscope to completely dry before reassembly. Any moisture on the threads will cause the c-mount camera and c-mount coupler windows to fog during use.



Warning: Not all sterilization trays are compatible with STERRAD® systems. Using an incompatible tray may result in incomplete device sterilization. Consult the instructions that came with your sterilization tray to determine which sterilization method is compatible with your tray and devices.

User Maintenance

Replacing the Fuses



To avoid the risk of fire, use only fuses of the value specified on the fuse label located on the rear panel of the console.

1. Unplug the power cord from the wall outlet and remove the cord from the console.
2. Unlatch the fuse holder above the AC inlet and remove it. (You may need to press the tab on the fuse holder with a slender screwdriver to release the latch.)
3. Replace the fuse with the same value and rating, as indicated on the rear panel.
4. Reinstall the fuse holder until the tab snaps in place.

Periodic Maintenance Schedule



To ensure safe operation of the Omni® 4K HDR Video System you should periodically perform the following procedure:

At a minimum of every 12 months, check to ensure the earth leakage current is $<500\mu\text{A}$ ($<300\mu\text{A}$ in U.S.A.), ground protective earth impedance is <0.1 ohms, power consumption is less than or equal to the rated power, and the unit will pass a dielectric withstand test of 1500V without breakdown. See IEC 60601-1 for test methods. If the unit fails these tests, send the unit back to the manufacturer for repair.

The Omni® 4K HDR Video System does not contain any user serviceable components.

NOTE: Refer questions about this or other operating details not included in this manual to your sales representative.

Disposal



This product contains electrical waste or electronic equipment.

It must not be disposed of as unsorted municipal waste and must be collected separately in accordance with applicable national or institutional related policies relating to obsolete electronic equipment. The Omni® 4K HDR Video System must be disposed of according to local laws and hospital practices.



WARNING: The Omni® Console contains a lithium coin battery which must be disposed of properly.

NOTE: Lithium batteries contain perchlorate material and special handling may apply. Please recycle according to local laws and practices.

Technical Specifications

NOTE: Technical data is subject to modification, revision and improvement without notice.

Table 1: System Information

Parameter	Parameter Value	
System Classification	FDA Class	Class II
	EU Class	Class I
	Health Canada Class	Class II
Safety Certifications	U.S.A. Certification	IEC 60601-1:2005+A1:2012
	Canadian Certification	CSA CAN/CSA-C22.2 NO. 60601-1:14
	EU Certification	IEC 60601-1:2005+A1:2012
EMC Certifications	CISPR 11 EMC Group	1
	CISPR 11 EMC Class	A
	EMC Certification	Radio Frequency Emissions in accordance with requirements of EN 60601-1-2: 2014+AMD1:2020 Radio Frequency Immunity in accordance with requirements of EN 60601-1-2: 2014+AMD1:2020
CE Marking	CE Marking for MDR EU 2017/745	

Table 2: Safety, General Information

General Information/Classification of Equipment	Parameter Value
Classification of installation and use	Moveable, Class 1, Type BF Applied Part
Type of Equipment	Medical Device
Intended Use	See Indications/Contraindications section
Mode of Operation	Continuous operation
Supply connection	Appliance coupler

Table 3: Specifications

Parameter	Parameter Value	
Power Requirements (Console)	Voltage:	100 – 240 V~
	Frequency:	50-60 Hz
	Power:	400 VA
Video Outputs	HDMI (4K):	3840x2160, Progressive Scan
Vertical Scanning Frequency	60 Hz	
White Balance Range	3000 to 7500 K	
Console Dimensions	Approximately:	5.3" (H) x 12.8" (W) x 12.8" (L) 13.5 cm (H) x 32.5 cm (W) x 32.5 cm (L)
Console Weight	Approximately:	11.7 lbs 5.31 kg
Camera Head Dimensions	Approximately:	2.0" (H) x 1.6" (W) x 4.8" (L) 5.1 cm (H) x 4.0 cm (W) x 12.2 cm (L)
Camera Head Weight	Approximately:	18 oz 510 g
Transport & Storage Conditions	Ambient Temperature:	-40°F to 122°F [-40°C to 50°C]
	Relative Humidity:	10% to 90%, non-condensing
	Atmospheric Pressure:	50.0 kPa to 106.0 kPa
Operating Conditions	Ambient Temperature:	+50°F to 86°F [10°C to 30°C]
	Relative Humidity:	30% to 75%, non-condensing
	Atmospheric Pressure:	70.0 kPa to 106.0 kPa

Table 4: Console Light Source Specifications

Parameter	Parameter Value	
LED Light Source Specifications	Color Temp	5700 K Nominal
	LED Life	30,000 hours
	Light Guide Port Turret	ACMI, Storz, Wolf and Olympus

Table 5: Radio Communications Specifications

Device	Frequency band (MHz)	Maximum Effective radiated power (ERP) (W)	Protocol	Modulation	Bandwidth (MHz)
Console	2400-2474	47.4 mW (+16.8 dBm)	WLAN 802.11b WLAN 802.11g WLAN 802.11n	DSSS OFDM OFDM	22 22 40
Tablet	2412 – 2472	50.5 mW (+17.0 dBm)	WLAN 802.11b WLAN 802.11g WLAN 802.11n	DSSS OFDM OFDM	22 22 40
	2402 – 2480	10.2 mW (+10.1 dBm)	Bluetooth	DSSS	1.4
	2402 – 2480	1.2 mW (+0.8 dBm)	Bluetooth LE	FHSS	0.7
	2400 – 2484	1.2 mW (+0.8 dBm)	ANT+	FHSS	1
	5180 – 5825	25.7 mW (+14.1 dBm)	WLAN 802.11a WLAN 802.11n WLAN 802.11ac	OFDM OFDM OFDM	20 40 80

Please contact your local sales representative for information on changes and new products.

Electromagnetic Compatibility

Like other electrical medical equipment, the Omni® 4K HDR Video System requires special precautions to ensure electromagnetic compatibility with other electrical medical devices. To ensure electromagnetic compatibility (EMC), the Omni® 4K HDR Video System must be installed and operated according to the EMC information provided in this manual.

NOTE: The Omni® 4K HDR Video System has been designed and tested to comply with IEC 60601-1-2:2014/A1:2020 requirements for EMC with other devices.

	<p>Do not use cables or accessories other than those provided with the Omni® 4K HDR Video System, as this may result in increased electromagnetic emissions or decreased immunity to such emissions.</p>
	<p>If the Omni® 4K HDR Video System is used adjacent to or stacked with other equipment, observe and verify normal operation of the Omni® 4K HDR Video System in the configuration in which it will be used prior to using it in a surgical procedure. Consult the tables below for guidance in placing the Omni® 4K HDR Video System.</p>
<p>Caution</p>	<p>Equipment which employs RF communications may affect the normal function of the Omni® 4K HDR Video System.</p>

Guidance and Manufacturer's Declaration: Electromagnetic Emissions		
<p>The Omni® 4K HDR Video System is intended for use in the electromagnetic environment specified below. The customer or the user of the Omni® 4K HDR Video System should ensure that it is used in such an environment.</p>		
Emissions test	Compliance	Electromagnetic Environment - guidance
RF emissions CISPR 11	Group 1	<p>The Omni® 4K HDR Video System is suitable for use in all establishments other than domestic establishments and those directly connected to the public low-voltage power supply network that supplies buildings used for domestic purposes, provided the following warning is heeded:</p> <p>Warning: This system is intended for use by health care professionals only. This system may cause radio interference or may disrupt the operation of nearby equipment. It may be necessary to take mitigation measures, such as reorienting or relocating the system or shielding the location.</p> <p>Note: The emissions characteristics of this equipment make it suitable for use in industrial areas and hospitals (CISPR 11 class A). If it is used in a residential environment (for which CISPR 11 class B is normally required) this equipment might not offer adequate protection to radio-frequency communication services. The user might need to take mitigation measures, such as relocating or re-orienting the equipment.</p>
RF emissions CISPR 11	Class A	
Harmonic emissions IEC61000-3-2	Class A	
Voltage Fluctuations/ flicker emissions IEC61000-3-3	Complies	

Guidance and Manufacturer's Declaration: Electromagnetic Immunity

The Omni® 4K HDR Video System is intended for use in the electromagnetic environment specified below.
The customer or the user of the Omni® 4K HDR Video System should ensure that it is used in such an environment.

Immunity Test	IEC 60601 Test Level	Compliance Level	Electromagnetic Environment: Guidance
Electrostatic Discharge (ESD) IEC61000-4-2	±8 kV contact ±15 kV air	±2,4,6,8 kV contact ±2,4,8,15 kV air	Floors should be wood, concrete, or ceramic tile. If floors are covered with synthetic material, the relative humidity should be at least 10 %.
Electrical fast transient/burst IEC61000-4-4	±2 kV for power supply lines (directly coupled) ±1 kV for input/output lines (capacitively coupled)	±2 kV for power supply lines (directly coupled) ±1 kV for input/output lines (capacitively coupled)	Mains power quality should be that of a typical commercial or hospital environment.
Surge IEC61000-4-5	±1 kV differential mode ±2 kV common mode	±0.5, 1 kV differential mode ±0.5, 1, 2 kV common mode	Mains power quality should be that of a typical commercial or hospital environment.
Voltage dips, short interruptions and voltage variations on power supply input lines IEC61000-4-11	0% Ut (100% dip in Ut) for 0.5 cycle 0% Ut (100% dip in Ut) for 1 cycle 70% Ut (30% dip in Ut) for 0.5 sec. 0% Ut (interruption) for 5 sec.	0% Ut (100% dip in Ut) for 0.5 cycle 0% Ut (100% dip in Ut) for 1 cycle 70% Ut (30% dip in Ut) for 0.5 sec. 0% Ut (interruption) for 5 sec.	Mains power quality should be that of a typical commercial or hospital environment. If the user of Omni® Video System requires continued operation during power mains interruptions, it is recommended that Omni® Video System be powered from an uninterruptible power supply or a battery.
Power frequency (50/60 Hz) magnetic field IEC 61000-4-8	30 A/m	30 A/m	Power-frequency magnetic fields should not exceed levels characteristic of a typical commercial or hospital environment.

NOTE: Ut is the AC mains voltage prior to application of the test level.

Guidance and Manufacturer's Declaration: Electromagnetic Immunity

The Omni® 4K HDR Video System is intended for use in the electromagnetic environment specified below.
The customer or the user of the Omni® 4K HDR Video System should ensure that it is used in such an environment.

Immunity Test	IEC 60601 Test Level	Compliance Level	Electromagnetic Environment: Guidance ³
Radiated RF IEC 61000-4-3	3 V/m 80MHz to 2.5 GHz	3 V/m 80MHz to 2.5 GHz	Field strengths from fixed RF transmitters, as determined by an electromagnetic site survey ⁴ , should be less than the compliance level in each frequency range. Specific guidance is given for some types of portable and mobile RF communications equipment on the following page.
Conducted RF IEC 61000-4-6	3 V ¹ (6 V ¹ in ISM and amateur radio bands ²) 150 kHz to 80 MHz	3 V ¹ (6 V ¹ in ISM and amateur radio bands ²) 150 kHz to 80 MHz	Other portable RF emitting equipment should be kept away at a minimum separation distance based on the maximum effective radiated power specified by the manufacturer of the equipment. The required separation can be calculated ⁵ as: $d = 2.33 \times \sqrt{ERP}$ where d is the distance in meters (m) and ERP is the effective radiated power in watts (W). Interference may occur in the vicinity of equipment marked with the following: 

NOTE 1: A conducted interference level of 3 V corresponds to a field strength of 3 V/m. A conducted interference level of 6 V corresponds to a field strength of 6 V/m.

NOTE 2: The ISM (industrial, scientific and medical) bands between 0.15 MHz and 80 MHz are 6.765 – 6.795 MHz; 13.553 – 13.567 MHz; 26.957 – 27.283 MHz; and 40.66 – 40.70 MHz. The amateur radio bands between 0.15 MHz and 80 MHz are 1.8 – 2.0 MHz; 3.5 – 4.0 MHz; 5.3 – 5.4 MHz; 7 – 7.3 MHz; 10.1 – 10.15 MHz; 14 – 14.2 MHz; 18.07 – 18.17 MHz; 21.0 – 21.4 MHz; 24.89 – 24.99 MHz; 28.0 – 29.7 MHz; and 50.0 – 54.0 MHz.

NOTE 3: These guidelines may not apply in all situations. Electromagnetic propagation is affected by absorption and reflection from structures, objects, and people.

NOTE 4: Field strengths from fixed transmitters, such as base stations for radio (cellular/cordless) telephones and land mobile radios, amateur radio, AM and FM radio broadcast, and TV broadcast, cannot be predicted theoretically with accuracy. To assess the electromagnetic environment due to fixed RF transmitters, an electromagnetic site survey should be considered. If the measured field strength in the location in which the Omni® 4K HDR Video System is used exceeds the applicable RF compliance level above, the Omni® 4K HDR Video System should be observed to verify normal operation. If abnormal performance is observed, additional measures may be necessary, such as reorienting or relocating the Omni® 4K HDR Video System.

NOTE 5: For example:	ERP, effective radiated power in watts (W)	0.01	0.1	1.0	10	100
	d, distance in meters (m)	0.23	0.74	2.3	7.4	23

Guidance and Manufacturer's Declaration: Electromagnetic Immunity

The Omni® 4K HDR Video System is intended for use in the electromagnetic environment specified below.

The customer or the user of the Omni® 4K HDR Video System should ensure that it is used in such an environment.

Recommended Separation Distances for Portable and Mobile RF Communications Equipment

The Omni® 4K HDR Video System is intended for use in an electromagnetic environment in which radiated RF disturbances are controlled. The user of the Omni® 4K HDR Video System can help prevent electromagnetic interference by maintaining minimum separation distances between portable and mobile RF communications equipment (transmitters) and the Omni® 4K HDR Video System.

The Omni® 4K HDR Video System has been tested for immunity at frequencies used by the following RF communications equipment:

Service	Minimum distance (m)	Maximum power (W)	Test frequency (MHz)	Immunity test level (V/m)
TETRA 400	0.3	1.8	385	27
FRS 460 GMRS 460	0.3	2.0	450	28
LTE Band 13, 17	0.3	0.2	710 745 780	9
CDMA 850 GSM 800 GSM 900 iDEN 820 LTE band 5 TETRA 800	0.3	2.0	810 870 930	28
CDMA 1900 DECT GSM 1800 GSM 1900 LTE Band 1, 3, 4, 25 UMTS	0.3	2.0	1720 1845 1970	28
Bluetooth LTE Band 7 RFID 2450 WLAN 802.11 b/g/n	0.3	2.0	2450	28
WLAN 802.11 a/n	0.3	0.2	5240 5500 5785	9

Warranty, Service, and Repair

Warranties

Your equipment has a one (1) year warranty from the date of shipment on workmanship and material defects.

Should your equipment need servicing under this warranty, please contact your distributor or your customer support specialist for return authorization documentation. You should carefully pack the product in a sturdy carton, including a note describing the defects, your name, your company name, telephone number and a return address. Warranty does not cover equipment subject to misuse, accidental damage, and normal wear and tear. This warranty gives you specific legal rights, and you may also have other rights that vary by region.

Please clean and sterilize all potentially contaminated products prior to returning them. It is unlawful to transport bio-contaminated products through interstate commerce, unless they are properly packaged and labeled as such.

If a return does not comply with these terms, the product may be destroyed at the customer's expense.

Technical Support and Product Return Information

Contact Hologic Technical Support if the Omni® 4K HDR Video System fails to operate as intended. If product is to be returned to Hologic for any reason, Technical Support will issue a Returned Materials Authorization (RMA) number. Return the Omni® 4K HDR Video System according to the instructions provided by Technical Support. Be sure to clean and sterilize the product before returning it and include all accessories in the box with the returned unit.

HOLOGIC®



Hologic, Inc.
250 Campus Drive
Marlborough, MA 01752 USA
Phone: 1.800.442.9892 (toll-free)
Email: GssTechSupport2@hologic.com
www.hologic.com



Santa Barbara Imaging Systems
340 Storke Rd, Suite 101
Goleta, CA 93117 USA



European Representative:

Qualrep Services BV
Utrechtseweg 310 Bldg-42
6812 AR Arnhem
The Netherlands
qualrep_services@qservegroup.com
Tel: + 31 (0)85 - 773 1409
Postal address: P.O. Box 674, NL-6800 AR
Arnhem, The Netherlands



Authorized Representative for Switzerland:

MedEnvoy Switzerland
Gotthardstrasse 28
6302 Zug
Switzerland



EU Importer:

Hologic Ireland Limited
70 Sir John Rogerson's Quay
Dublin 2, Ireland

CH Importer:

Hologic Medicor Suisse GmbH
Gewerberstrasse 10,
CH-6330 Cham ZG,
Switzerland

UK Importer:

Hologic Ltd
Oaks Business Park,
Crewe Road, Wythenshawe,
Manchester, M23 9HZ,
United Kingdom

Australian Sponsor:

Hologic (Australia and New Zealand) Pty Ltd
PO Box 1971, Macquarie Centre, NSW, 2113
Australia

Hologic®, Omni® and associated logos are trademarks and/or registered trademarks of Hologic, Inc. and/or its subsidiaries in the United States and/or other countries.

STERRAD® is a registered trademark of Advanced Sterilization Products.
STERRAD NX™, STERRAD 100NX™, and CIDEX™ are trademarks of Advanced Sterilization Products.