

Faxitron[®] Path

Specimen Radiography System

User's Manual

from Hologic[®]

Document #: 5081-9534

Revision: 024

Issued: August 2021

Faxitron Path was previously known as PathVision

HOLOGIC[®]

Faxitron™ Path

Specimen Radiography System

© 2005-2021 Hologic Inc.

All rights reserved. No parts of this work may be reproduced in any form or by any means - graphic, electronic, or mechanical, including photocopying, recording, taping, or information storage and retrieval systems - without the written permission of the publisher.

Products that are referred to in this document may be either trademarks and/or registered trademarks of the respective owners. The publisher and the author make no claim to these trademarks.

Read all this information carefully before operating the system. Follow all warnings and precautions as stated in this manual. Keep this manual available during procedures. Always follow all the instructions in this manual. Faxitron Bioptics, LLC does not accept responsibility for injury or damage from incorrect system operation. Faxitron Bioptics, LLC can arrange for training at your site.

Issued: August 2021

	Table of Contents	0-3
	Forward	0-5
	Indications for Use	0-5
SECTION 1:	Faxitron Path Introduction	1-1
1.0.0	Introduction	1-2
	Manufacturer and Contact Information	1-2
1.1.0	Warning and Caution Symbols in this Manual	1-2
1.1.1	Warning and Caution Symbols on Labels	1-3
SECTION 2:	Faxitron Path Installation and Set-up	2-1
2.1.0	System Warnings & Precautions	2-2
2.2.0	Faxitron Path System Setup	2-4
2.3.0	Specifications	2-5
SECTION 3:	Camera Calibration	3-1
3.1.0	Calibration	3-2
SECTION 4:	Quick Start - Basic Operation of the Faxitron Path	4-1
4.1.0	Quick Start	4-2
4.2.0	Image Acquisition	4-3
SECTION 5:	Vision Software Operation	5-1
5.0.0	Overview of Vision Software	5-2
5.1.0	Software Start-up	5-2
5.2.0	Camera Calibration Overview	5-3
5.2.1	Advanced Calibration	5-4
5.3.0	Patient Data	5-5
5.3.1	Select from Work List	5-6
5.3.2	Continue with Current Patient	5-7
5.3.3	Manual Entry	5-7
5.3.4	Select from Database	5-8
5.3.5	Patient Data Icon	5-9
5.4.0	Tool Bar and Menus	5-11
5.4.1	Side Tool Bar	5-11
5.4.2	Top Menu Bar	5-16
5.4.3	View Menu	5-16
5.4.4	Tools Menu	5-19
5.4.5	Image Tools	5-22
5.5.0	Current Patient Images Browser	5-27
5.6.0	Database	5-27
5.6.1	Database Additional Options	5-29
5.7.0	DICOM Functionality	5-32
5.8.0	User Annotations	5-39

5.9.0	About Help	5-42
5.10.0	About Vision Software	5-42
SECTION 6:	Compliance Requirements and Safety Measures	6-1
6.1.0	Compliance Requirements and Safety Measures	6-2
6.2.0	DICOM Standard	6-4
SECTION 7:	Service & Troubleshooting	7-1
7.1.0	Service & Troubleshooting	7-2
SECTION 8:	Schedule of Maintenance	8-1
8.0.0	Maintenance	8-2
8.1.0	Internal	8-2
8.2.0	External	8-2
8.3.0	Replaceable Parts	8-2
8.4.0	Materials Needed	8-2
8.5.0	Reference Documents and Version Information	8-2
8.6.0	Definitions	8-3
8.7.0	Periodic Maintenance	8-3
8.8.0	Safety Interlocks and Indicators	8-4
8.8.1	ACR Phantom Test	8-5
8.8.2	Radiographic Survey	8-6
	Periodic Maintenance Record Sign Off Sheet	8-8
SECTION 9:	Revision History	9-1
	Revision Table	9-2

Faxitron™ Path

Specimen Radiography System

Forward

This manual was created by Hologic® Inc. It is intended to guide the user on how to setup, install and use the Faxitron Path hardware and the Vision Software System, both developed by Hologic® Inc..

Faxitron Path was previously known as PathVision

The user must first setup the hardware, then initiate the Vision Software. Please review the required setup procedures in Part 2 of this manual before continuing.

Indications for Use

The **Faxitron Path** is a Cabinet x-ray system that is used to provide film and/or digital x-ray images of harvested specimens from various anatomical regions in order to provide rapid verification that the correct tissue has been excised during the biopsy procedure. Doing the verification directly in the same room or nearby enables cases to be completed faster, thus limiting the time the patient needs to be under examination. Specimen radiography can potentially limit the number of patient recalls.

✓Prescription use (Part 21 CFR 801 Subpart D)

Caution: Federal law restricts this device to sale by or on the order of a physician.

The system can operate as a standalone device. If connected to a network, it is critical that measures are implemented to reduce the risk to patients by decreasing the likelihood that device functionality is intentionally or unintentionally compromised by inadequate cybersecurity.



www.hologic.com/package-inserts

1

SECTION 1 **Introduction**

Faxitron™ Path

Specimen Radiography System

This manual was created by Hologic Inc. It is intended to guide the advanced user on how to setup, install and use the Faxitron Path hardware and Vision Software, both developed by Hologic Inc.

Read all this information carefully before operating the system. Follow all warnings and precautions as stated in this manual. Keep this manual available during procedures. Always follow all the instructions in this manual. Hologic Inc. does not accept responsibility for injury or damage from incorrect system operation. Hologic can arrange for training at your site.

Thank you from all of us at Hologic Inc.

1.0.0 Introduction

Manufacturer and Contact Information



Hologic, Inc.
36 Apple Ridge Road
Danbury, CT 06810 USA
1.800.447.1856
www.hologic.com



Hologic, BV
Da Vincilaan 5
1930 Zaventem
Belgium
Tel: +32 2 711 46 80
Fax: +32 2 725 20 87



AU SPONSOR

Hologic (Australia and New Zealand) Pty Ltd
Suite 302, Level 3
2 Lyon Park Road
Macquarie Park NSW 2113
Tel: 02 9888 8000

BRAZILIAN CONTACT

PASSROD IMPORTAÇÃO E EXPORTAÇÃO DE PRODUTOS PARA SAÚDE LTDA ME
Rua Alice Alem Saadi nº 855 - sala 2404 – Nova Ribeirânia,
Ribeirão Preto/ SP,
Brazil, 4096-570

The following symbols are used in this manual and online help system:



Warns the reader of potential electrocution should the reader ignore the warning and deliberately use specialized tools to open a sealed electrical cabinet and handle its contents. Note: No tools are provided by Faxitron Bioptics LLC.



Warns the reader of a hazardous condition. This symbol is generally accompanied by a more specific symbol and appropriate instructions as to the nature of the hazard, the expected outcome of the hazard, and information on avoiding the hazard.



Cautions the reader to use care in lifting heavy equipment in order to avoid personal injury and damage to the equipment.



Warns the reader that ionized radiation is emitted into the labelled area when the x-ray beam is energized. The Faxitron Path has safety interlocks to prevent the labelled area from being accessed while the x-ray beam is energized.















Warns the reader to use appropriate protection (such as surgical gloves or an approved specimen container) to avoid exposure to potentially infectious materials such as patient tissue samples.

1.1.0 Warning and Caution Symbols in this Manual

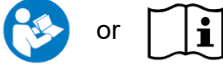
Faxitron™ Path

Specimen Radiography System

1.1.1 Warning and Caution Symbols On Labels

Symbol	Description
	Discard electrical and electronic equipment separately from standard waste. Send decommissioned material to Hologic or contact your service representative.
	Manufacturer
	Date of Manufacture
	Caution—Radiation (X-Rays Produced)
	Caution - Potentially infectious materials
	Warning Electricity
	Caution
	Follow or consult instructions for use
	This system transmits radio frequency (RF) energy (non-ionizing radiation)
	European Authorized Representative
	Medical Device
	Catalog number
	Serial number

2

SECTION 2
Faxitron Path
Installation and Set-up

Warnings

- Please read the instructions carefully before using the system.
- Do not use the system in any other way than its intended use as described in this manual. If in doubt contact Faxitron/Hologic or your authorized distributor.
- Not all power cords have the same rating. Do not use any other power cord with this system other than the one provided. Do not use the power cord from this system on any other equipment.
- This system is tested to the highest international standards; however, it is recommended that you contact your national authorities regarding any local operational requirements.
- This system is not intended for public use. It must be located in an area where the general public cannot access the system without an operator being present.

2.1.0 System Warnings & Precautions



General Precautions

The following precautions must be taken to prevent damage to your Path System:

- Never connect or disconnect communication and/or power cables, while the camera system power is on. Damage to the CMOS detector or the camera electronics may occur if the cables are connected / disconnected while the power is on.
- The camera system is fragile, and care should be taken in order to prevent camera damage. The camera system must never be mishandled, hit, knocked or dropped.
- The Path System has a calibration mode. Calibration must be completed daily to ensure proper system function. Please refer to the Calibration Procedure.
- Caution – Use of controls or adjustments to perform procedures other than those specified herein may result in hazardous radiation exposure.



Interoperable Connections

The Path is capable of operating as a standalone device without any input or output to other devices. Images can be captured, stored and reviewed directly on the system.

However, the system does come with several interfaces. The primary one is the network connection which allows the system to be connected to a Picture Archiving and Communication System (PACS). Images can then be transmitted from the device directly to the facilities network via our software in a DICOM format. See Section 6 for details on DICOM version. Only Faxitron employees or trained IT personnel at the user facility should set up this communication.

The system's connections and their intended use are listed below. No other type of devices should be connected to the Path without approval from Faxitron.

Connection	Purpose	Device Type	Intended User
Ethernet port at rear	To store radiographic images to networked data storage	PACS or Network storage	Set up by Faxitron or facility IT personnel. Used by clinicians.
Ethernet port at rear	To allow remote connection by the Faxitron service team, so Faxitron can diagnose and repair the system.	Network internet connection	Faxitron or facility IT personnel
USB port at the front	To transfer images from device. This should only be used if PACS or network is not available.	USB storage device (Flash Drive)	Clinicians or IT personnel with approved access to the system.
USB port at the front	To service and maintain the system files may need to be copied to and from the computer. For example, software updates or log files.	USB storage device (Flash Drive)	Faxitron or facility IT personnel
USB port at the rear	To allow connection of a printer. Vision software allows for connection of a DICOM printer or a standard windows compatible printer.	DICOM or windows printer	Clinicians or facility IT personnel

Cybersecurity

Device security is a shared responsibility between Faxitron and the health care facilities. Failure to maintain cybersecurity can result in compromised device functionality, loss of data (medical or personal) availability or integrity, or exposure of other connected devices or networks to security threats. Faxitron maintains a set of cybersecurity controls to assure the cybersecurity of its units and to maintain their functionality and safety.

All our units use standard Windows operating system. At installation, we recommend the facility install all the necessary security measures as defined by their own internal requirements, as they would with any other PC connected to the network.

The facility can set up the Windows operating system with all the network protocols and permissions necessary. For example, they can add:

- User ID and passwords,
- Layered authorization with appropriate authentication,
- Restrictions on software installations,
- Trusted content requirements, including code signature verification,
- Set up windows updates including security releases.

In addition, our imaging software (Vision) can be password protected so certain users can get on to the operating system without being able to open the Vision software.

The unit comes with a physical key that powers on the X-Ray system. This allows the system to be locked out so even if the software is accessed no x-rays can be initiated.

This unit is designed to be used either as a standalone unit or connected to the Facility's internal PACS or other closed-loop network. It is not intended to be connected to the Internet, unless (a) the Facility is specifically instructed to do so by Faxitron, or (b) the Facility takes adequate precautions to ensure the cybersecurity of the unit from threats related to its Internet connection.

Faxitron will develop updates or patches for the Faxitron software to continue to assure the product's safety, as needed throughout the lifecycle of the unit.

Additional security measures, including encryption, can be implemented and Faxitron can work with the facilities IT department to reduce the risk to patients as a result of cybersecurity breach.

Cleaning

Internal Chamber

Samples containing biological specimens can harbour infectious agents that are hazardous to your health. Follow appropriate biosafety procedures: wear gloves when handling tissue specimens or any material which they come in contact with.

Periodically wipe down the interior of the cabinet with 70-90% isopropyl alcohol or diluted sodium hypochlorite (5.25%-6.15% household bleach diluted 1:500 provides the proper concentration). Ensure the specimen area, marked on the chamber floor, is thoroughly cleaned.

External Chamber

Periodically wipe down the exterior surfaces with isopropyl alcohol, sodium hypochlorite, or mild soap and water. (See above for appropriate concentrations.) Do not drench or flood surfaces and do not use abrasives which may scratch surfaces. Do not allow any moisture to contact any of the systems electrical components. Test cleaning agents on a small inconspicuous area of the plastic and metal covers to verify they will not damage the finish.

2.1.0 Cont.



Inspecting the Crates

The Faxitron Path System arrives in one large wood crate and one box. Have the shipping agent transport the crate and box to an area where they can be kept safe from theft, damage, or environmental extremes until the Hologic authorized representative can install the system.

Check crate and box for any damage. If either appears to be damaged, contact Hologic at 1-800-447-1856.

The crate is about four feet tall. This crate contains the specimen unit, computer and system manuals. The box contains the system monitor.

Lifting and Transporting the Crate

Caution: The crate weighs approximately 550 pounds (250 kg). The packaged system should be kept upright as indicated on the shipping crate.



Unpacking and Assembling the System

The Faxitron Path system should be unpacked and setup by a Hologic Inc. authorized representative.

Location

The Faxitron Path system has ventilation and the power entry connector at the rear of the cabinet. Leave at least 6" (15cm) of clear space behind the unit when installed to allow adequate air flow and give the user access to disconnect the power cord.

2.2.0 Faxitron Path System Setup

Environmental Conditions

2.3.0 Specifications

Operational:

Temperature: 15.5 to 30 degrees C or 60 to 86 degrees F.
Relative humidity: < 75 %.

Storage and transport:

Temperature: 0 to 45 degrees C or 32 to 113 degrees F.
Relative humidity: < 75 %.

This equipment is designed for the following conditions:

- Indoor use
- Altitude up to 2000 meters
- Pollution Degree 2
- Over-voltage Category II

The Faxitron Path should not be moved once installed. The system was designed as a stationary unit to be set up on a counter or tabletop.

RADIATION SAFETY

- Radiation shielded cabinet.
- Compartment door equipped with dual safety interlocks.
- Radiation: Less than 0.1 mR/hr at 5 cm (2 in.) from exterior surface at maximum kV.
- Certified to comply with standards set by the US Food and Drug Administration, Center for Devices and Radiological Health, (21 CFR 1020.40).
- Designed to comply with standards set forth by Underwriters Laboratory the US and Canada
- Faxitron recommends that users receive training in basic ionizing radiation safety before using the system.

EXPOSURE CONTROL: Automatic or Manual.

X-RAY DUTY CYCLE: 50%

LASER INFORMATION: Class 1 Laser Product

IEC 60825-1 Ed. 2

Complies with 21 CFR 1040.10 and 1040.11 except for deviations pursuant to Laser Notice No. 50, dated June 24, 2007.

POWER REQUIREMENTS: 100 – 250 VAC, 50/60 Hz, 200 VA Max

HEAT OUTPUT: 500 BTU/hr Max

EXTERIOR DIMENSIONS (Approximate)

2.3.0 Cont.

	cm	inches
Height	90	36
Width	59	23
Depth	54	21

COMPARTMENT INTERIOR DIMENSIONS (Approximate)

	cm	inches
Height	57	22.3
Width	39	15.5
Depth	42	16.5

WEIGHT (Approximate)

	With Computer, monitor, keyboard and accessories	
	kg	lbs
Net	210	465
Shipping	258	570
	Cabinet Only	
Net	188	415
Shipping	236	520

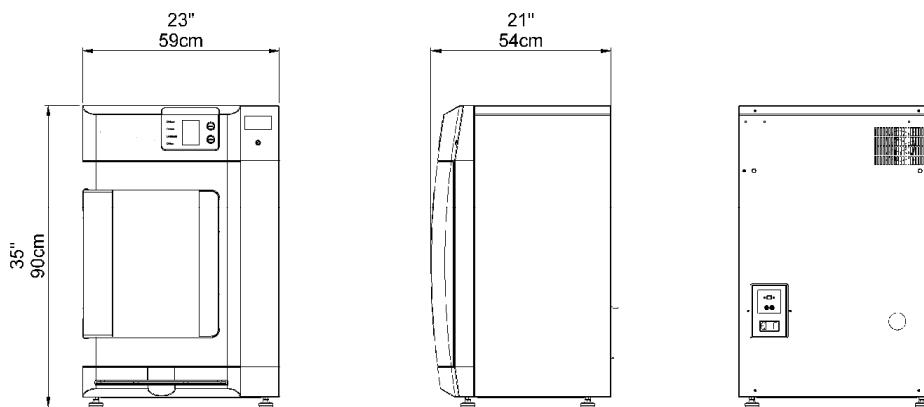

3

SECTION 3
Camera Calibration

Calibration

Upon initial start-up of the system or at any time desired by the user, a system calibration may be performed. Upon initial start-up and after an elapsed time of twelve (12) hours, the following calibrations must be performed.

To optimize image quality, Vision Software and the hardware requires periodic calibration. This calibration requires the acquisition of reference images. These images can be grouped into three (3) categories: Offset images, Dark images and Flat-field images.

The Vision software will either open directly to the Home Menu (Figure 3.1.1) or the Calibration page (Figure 3.1.2) depending on the elapsed time since the last calibration. The user can navigate to the Calibration page in order to manually start a calibration.

Caution: Verify the chamber is empty prior to starting calibration.

To manually start Calibration, click on the “Calibrate” button in the Home Menu.

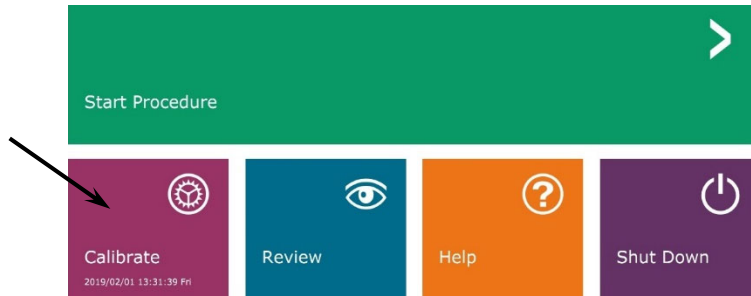

Figure 3.1.1
Calibrate System Button

The user will then be prompted to start the calibration.

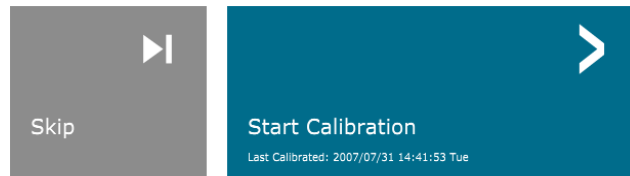

Figure 3.1.2
Start Calibration prompt

ENSURE THE CHAMBER IS EMPTY BEFORE CALIBRATION
Calibration before beginning any procedure is recommended

Once pressed, the calibration process is performed, and the calibration message box is displayed. During calibration the message box will toggle between “SYSTEM IN CALIBRATION” and “X-RAY ON”. See Figure 3.1.3.



Figure 3.1.3
Calibration Progress

The software will automatically go to the Home Menu page when calibration is complete.

Refer to Sections 5.2.0 and 5.2.1 for additional information on calibration.

4

SECTION 4
Quick Start
Basic Operation of the
Faxitron Path

Before powering up the system, please make sure that all cords and cables are securely plugged into the system, computer, and monitor.

Refer to Section 2, Installation and Set-up, of this manual, and the Quick Set-Up and Quick Start Guides provided with your Path system.

4.1.0 Quick Start

Figure 4.1.1
Path front panel

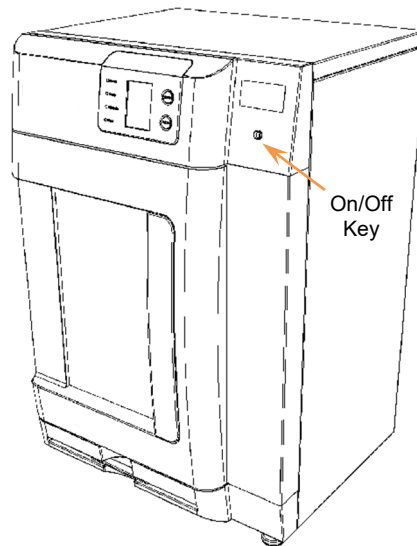

System Start-up Sequence Protocol

This start-up sequence must be followed to ensure proper system function and image quality.

Power Up System

- Set the power switch on the back of the Path cabinet to the "ON" position.
- Turn the key on the front of the Path cabinet to "ON" (clockwise to the three o'clock position).
- Turn the computer and monitor "ON".

Start Software

- Verify there is nothing in the Path x-ray chamber.
- The Vision software should automatically start when the Windows operating system has completed booting. If the software doesn't automatically start "Double Click" the Vision Icon on the Windows desktop.



Figure 4.1.2
Vision Desktop icon

Calibrate

- Upon initial start-up of the day the software should open to the Calibration page.
- Press the "Calibrate" button and allow the system to complete the calibration.

Additional Recommendations for Consistent image Quality.

Allow the system to perform a complete calibration daily prior to initial system use. The system is configured to perform this calibration when you start the Vision software.

Perform a complete system calibration after moving the system to another room to avoid potential imaging difficulties associated with room-to-room ambient temperature and humidity differences.

Basic Imaging Procedures

Warning: Use of the Path in a manner other than that described in this manual may result in impaired operation of the equipment or personal injury.

Warning: Use approved containers or gloves in order to avoid contact with potentially hazardous patient tissue samples.

Start Procedure

- From the Home Menu page select the **Start Procedure** button.

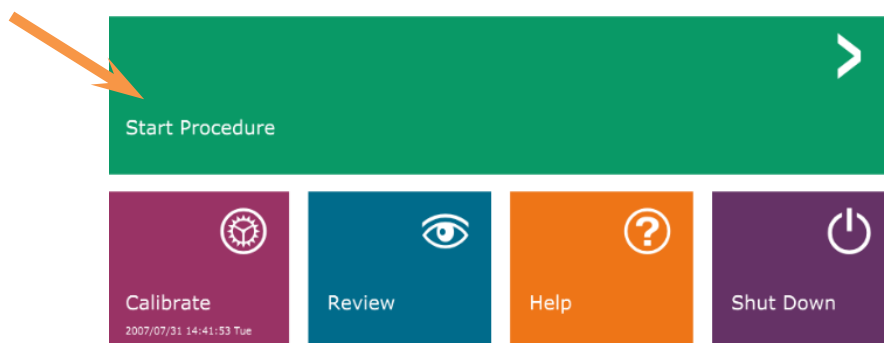

- The user will be given options to **Select form Work List**, **Manual Entry**, **Select from Database**, or **Continue with current patient**.
- To manually enter a new Procedure, select the **Manual Entry** button.

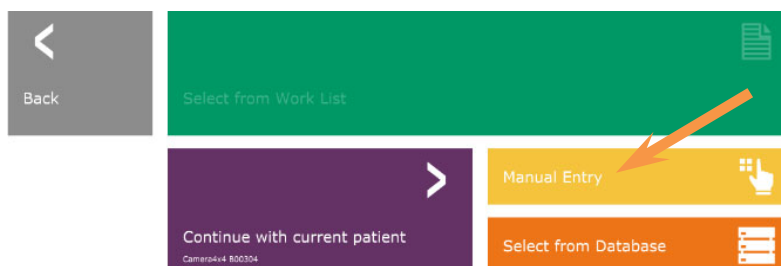

- The "Patient Information Editor" dialog box will open.

4.2.0 Image Acquisition



Figure 4.1.3
Faxitron Vision program Home
Menu (Main Screen)

Figure 4.1.4
Start Procedure Options

4.2.0 Cont.

Figure 4.1.5
Patient Data screen

Note: Required Fields are indicated by a white asterisk (*).
Default required fields are: Patient Name, Patient ID, Accession Number, and Laterality.



- Enter all required fields. The **Accept** button will not be active if any required field is missing. The user may complete other fields as desired.

Note: Date of Birth must be entered as yyyy/mm/dd (e.g. 1962/08/13).

- Select **Accept** to enable image acquisition.

X-Ray Imaging

- Place specimen(s) in a specimen container provided by Faxitron Bioptics LLC, or your institution, and lay it inside the Path x-ray chamber. The imaging area is designated by an outline decal. (The user may also place the specimen and container on the magnification tray provided with the Path system.)
- Press the green **Start X-ray** button (either in the software or on the front of the x-ray cabinet) to initiate image acquisition/x-rays.
- Wait until image is displayed.

Note: With the Full Auto mode selected, two X-Rays will be taken, the first to work out the best settings and the second to take the image. The settings used during exposure (kV and time) will be displayed in the cabinets' LCD screen.

The Vision software is configured to automatically save the image to the Faxitron database on the system computers' local drive. The user can also save the image to the facilities server by clicking on the **PACS** icon. See Figure 4.1.6

4.2.0 Cont.

*Figure 4.1.6
Image Screen*

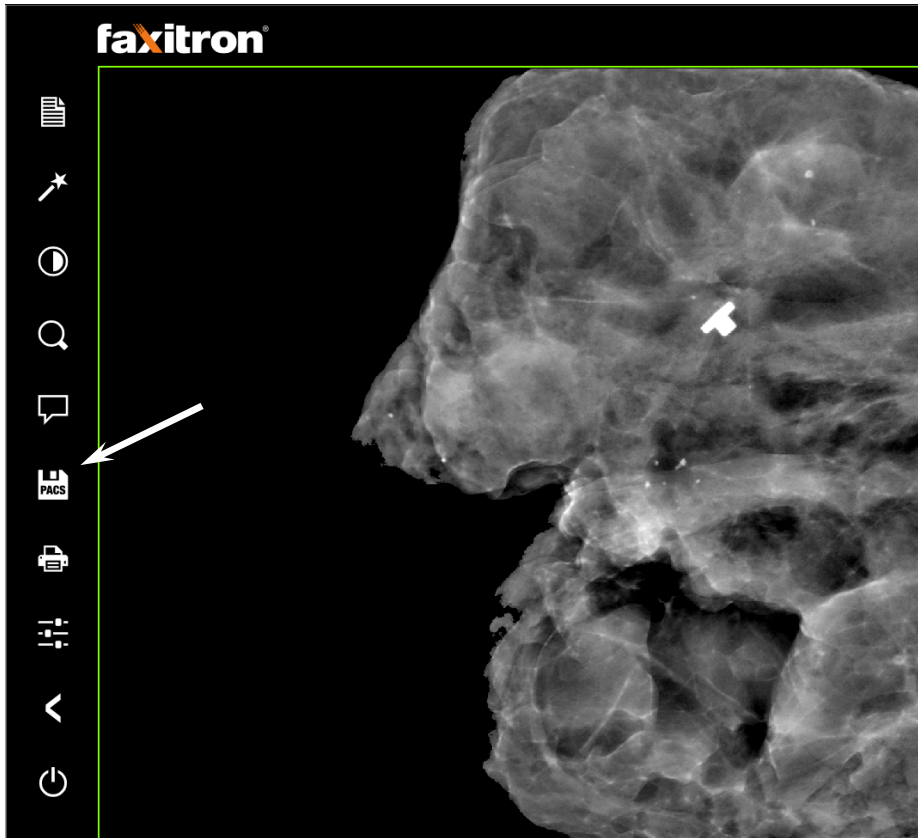

For more information on adjusting the image settings, X-ray controls, and reviewing and save options, see Section 5.

5

SECTION 5
VISION Software
Operation

Vision Software is a complete image acquisition and processing package, designed exclusively to work with Faxitron X-Ray Generators (such as VersaVision, Faxitron Path, CoreVision and BioVision Systems.) In addition to the acquisition and processing functions, the software offers an extensive database module that allows user control and maintenance of image archiving, storage, filing and retrieval. The software is also Digital Imaging and Communications in Medicine (DICOM) compliant, allowing saving and printing of Patient images in DICOM format 3.0. The software has been pre-installed on the computer that was packaged with your x-ray system.

System calibration is required at the beginning of every new day of system use for best image quality. The system user may also perform calibration at any time to ensure optimum image quality.

After calibration, the Home Menu will be displayed, which allows navigation to all other areas of the software. For ease of use, application buttons are provided, *see Figure 5.0.1*. These buttons are in the center of the screen. Button descriptions and definitions are outlined in the following sections of this manual.

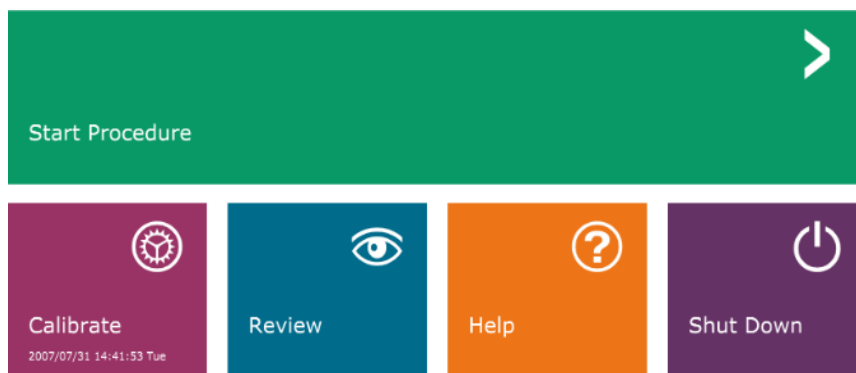

Figure 5.0.1
Faxitron Vision Software
Home Menu (Start-up Screen)

Sequence Protocol

The start-up sequence must be followed to ensure proper system functionality and image quality.

Apply power to the Faxitron Path cabinet using the switch on the back of the cabinet. (The mains power switch is next to the power cord receptacle). Depress “1” for “Power ON” and “0” for “Power OFF”.

Turn the Faxitron Path cabinet “ON” by inserting the Faxitron Path Key into the key lock switch, located on the front panel, and turning it clockwise to the 3 o’clock position. Note: the key cannot be removed in this position.

Turn on the computer and monitor.

The Vision software will automatically start when Windows has completed its’ boot sequence. A Dialog box will appear to indicate the software has initialized and is loaded. NOTE: Double click the left mouse button on the **Vision Software** icon (*located on the Windows desktop*) if Vision does not automatically start. *See Figure 5.1.1*.



Figure 5.1.1
Vision Software Desktop Icon

Vision software will open to the Home Menu or the Calibration page depending on elapsed time since the last system Calibration.

Refer to Section 3, “Camera Calibration”, and Section 5.2.1, “Camera Calibration Overview” for calibration protocols.

5.1.0 Software Start-up



Calibration Introduction

To optimize image quality, Vision Software and the hardware requires periodic calibration. This calibration requires the acquisition of reference images.

Upon initial start-up of the system or at any time desired by the user, a system calibration may be requested and performed. It is recommended that after an elapsed time of twelve (12) hours, the following calibrations be performed.

These reference calibration images are used to calibrate a "raw" X-Ray image on a pixel-by-pixel basis to generate a "corrected" image for display. Image corrections performed include gain, offset and linearity corrections.

Calibration Sequence

For convenience, Vision software combines the numerous steps of calibration into a single unified step.

When a Faxitron X-Ray System has been turned off for longer than twelve (12) hours, the system will automatically request to re-calibrate. It is highly recommended that the system be re-calibrated after extended periods of inactivity or after the system is moved from one room to another room with potentially different ambient temperature/humidity settings.

To calibrate the system at any time, click the **Calibrate** button on the Vision Home Menu (Start-up Screen) and then press **Start Calibration**. See Figures 5.2.1 & 5.2.2. The Dialog will display a status message during calibration. See Figure 5.2.3.

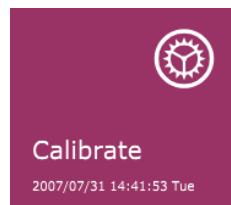

Figure 5.2.1
Home Menu Calibrate button

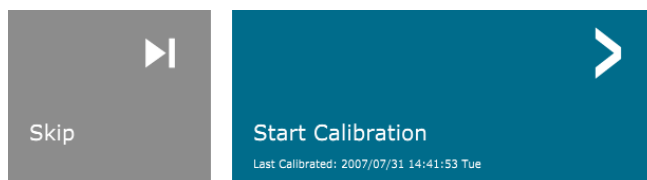

Figure 5.2.2
Start Calibrate button

ENSURE THE CHAMBER IS EMPTY BEFORE CALIBRATION
Calibration before beginning any procedure is recommended



Figure 5.2.3
Calibration Status

During calibration, X-Rays may be generated. During X-Ray generation, a **Stop X-Ray** button will be made visible to allow a user the option to stop X-Ray through software.

Occasionally it may be desirable to incorporate the X-Ray attenuation characteristics of a uniform attenuator in the flat-field reference calibration images. For example, if all objects to be imaged are placed on a thin plastic plate, X-Ray attenuation characteristics of the plate will be observed in every image acquired. In this case, placing the plate in the X-Ray beam during flat-field reference calibration image acquisition could improve image quality. The following is a summary of the advanced calibration protocol for "Both" (Flat Field and Image):

Place the uniform attenuator on the detector. The entire detector surface should be covered by the attenuator. For ideal results, the attenuator should be larger than the detector's imaging area.

From the start-up screen of the imaging software, press the top-right  icon to bring the menu into focus. Select the drop down menu item "Tools" in the horizontal menu located at the top of the screen, and then proceed to "Advanced Tools" then to "X-Ray Calibration/Exposure Setup".

5.2.1 Advanced Calibration

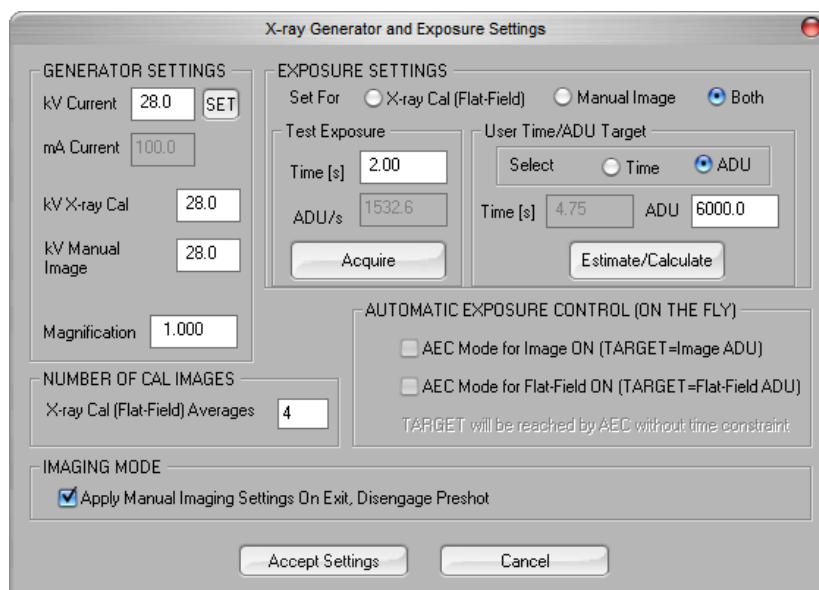

Figure 5.2.4
X-Ray Generator and Exposure
Dialog Box

NOTE: The kV, Exposure Time, and ADU/s values may vary from those shown.

- Under "X-Ray Generator and Exposure Settings", enter the generator kV setting in the appropriate field.
- Set a "Magnification" or leave as the default setting of one (1.0).
- Select the "Set for" "Both" button in the dialog box.
- Leave the default "user ADU target" setting. X-Ray exposure will be terminated when the detector has accumulated a mean signal level of ADUs that are acceptable for the X-Ray generator you have.
- Leave the default test exposure time and click on the **Acquire** button. The system will automatically begin X-Rays and obtain an image.
- When the X-Ray exposure is complete, click on the **Estimate/Calculate** button.
- Record the calculated exposure time "Time [s]" reading. The system calculates this time and the number is greyed out.
- Enter the calculated exposure time reading "Time [s]" in the "Test Exposure" time box. Press the **Acquire** button to automatically begin X-Rays and obtain an image.

- When X-Ray exposure is complete, click on the **Estimate/Calculate** button.
- Record the calculated exposure time "Time [s]" reading.
- Enter the calculated exposure time reading in the "Test Exposure" time box once again.
- Click on the **Accept Settings** button.
- Perform a standard calibration procedure, as described in the "Camera Calibration Overview" section.

5.2.1 Cont.

Experienced users may wish to set the "X-Ray Cal (Flat-Field)" and "Manual Image" "Exposure Settings" independently or "Both" (Flat-Field and Manual Image) as previously described. By selecting the "Flat Field" radio button, the system will determine the optimum exposure time for acquiring Flat Field images at the desired ADU level. Accordingly, the selection of "Manual Image" will determine the optimum exposure time for the system with an object which will attenuate the X-Ray signal. For best results, the entire imaging area of the detector must be covered by the object.

After the selection of either "X-Ray Cal (Flat-Field)" and "Manual Image" and the ADU level has been set, select the **Acquire** button. For the "Manual Image" selection, it is desired to have the object or X-Ray attenuator in the X-Ray beam. Press the **Acquire** button to generate X-Rays and obtain an image. When X-Ray exposure is complete, click on the **Estimate/Calculate** button. The system calculates optimum time and the number is greyed out. Click the **Accept Setting** button to save the "Exposure Settings" to the system's configuration file. **Note: Only the settings for the selected radio button are saved.** Next perform a standard calibration procedure, as described in the "Camera Calibration Overview" section.

The **Start Procedure** button, (see Figure 5.0.1), takes the user to the Patient Data Entry page which provides methods to enter patient data. If a Work List has not been configured, the option will be greyed out and only the **Continue with current patient, Manual Entry, and Select from Database** options will be accessible. The options are explained in the next sections.

5.3.0 Patient Data

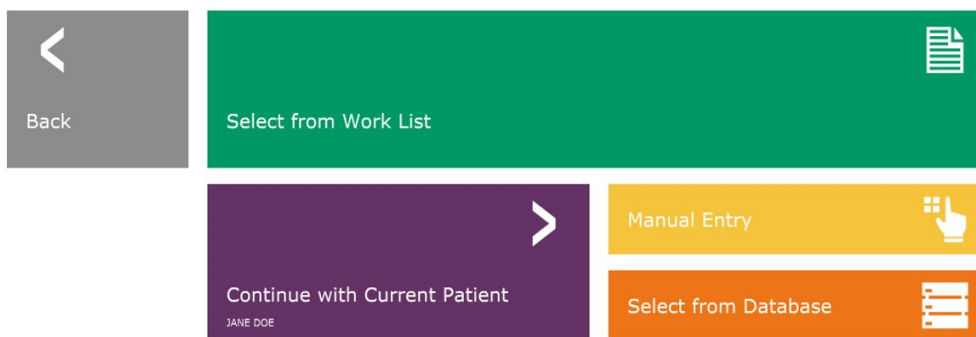

Figure 5.3.1
Patient Data Entry screen

SELECT FROM WORK LIST (Remote Modality Work List)

If a Work List has been configured the user can click the **Select from Work List** button which will display the following page. See Figure 5.3.2 below.

5.3.1 Select from Work List

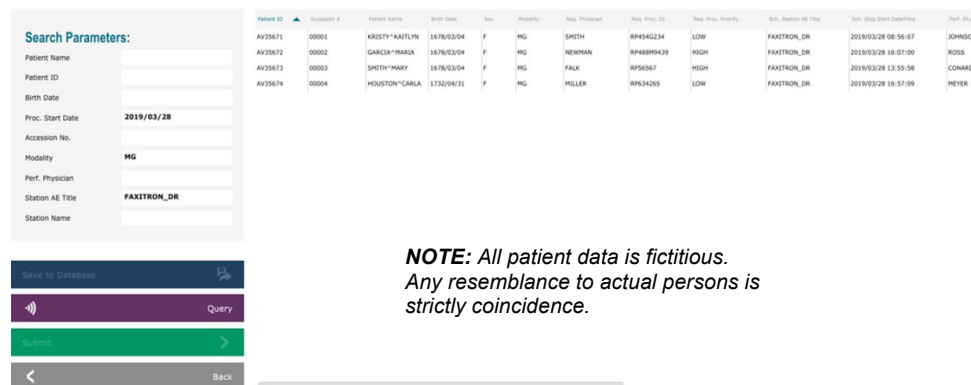

Figure 5.3.2
Modality Worklist Search Dialog

NOTE: All patient data is fictitious.
Any resemblance to actual persons is strictly coincidence.

On the left are various filters that may be used to search for scheduled procedures for the Station Application (AE). Verify that the station AE Title is defined, then any single field or any combination of fields may be used as a filter to search for scheduled procedures for this AE. By selecting the **Query** button located in the bottom left corner, the table is re-populated with the entries that match the queried information.

The user can then single-click any entry and hit **Submit** to automatically populate the Imaging Information Editor with the patient information.

NOTICE: The user may also double click any entry within the table to quickly go into the Imaging Information Editor without having to press **Submit**.

The Imaging Information Editor (Patient Information Dialog) will open. See Figure 5.3.3. Complete remaining required fields and click on **Accept** to proceed to image acquisition.

Note: Required Fields are indicated by a white asterisk (*). Default required fields are: Patient Name, Patient ID, Accession Number, and Laterality.

The user must enter all required fields prior to being able to select the **Accept** button. The user may also enter a Date, Referring Physician, Procedure Name, Sex, Technician, Position View, Body Part, and Study ID if so desired. The Procedure Name, Position View and Body Part are chosen by a drop down menu.

Note: The Date must be entered as yyyy/mm/dd (e.g. 1962/08/13). Failure to enter a valid date may cause errors when attempting to retrieve images.

Note: The "required fields" may be altered or deleted depending on the application. Contact Faxitron support for further information.

Select **Accept** to continue or **Start a New Patient or Procedure** to return to the Patient Data Entry page.

5.3.1 Cont.

Figure 5.3.3
Imaging Information Editor

Continue with Current Patient

Click on this button to **continue with current patient** procedure. The "Imaging Information Editor" will open. See Figure 5.3.3. Follow the above procedure and notes.

5.3.2 Continue with Current Patient

Manual Entry

Click on this button to **manually** enter a new Procedure. The "Imaging Information Editor" will open. See Figure 5.3.3. Follow the above procedure and notes.

5.3.3 Manual Entry

Select from Database

Choosing the **Select from Database** button will display the following page. See *Figure 5.3.4 below*.

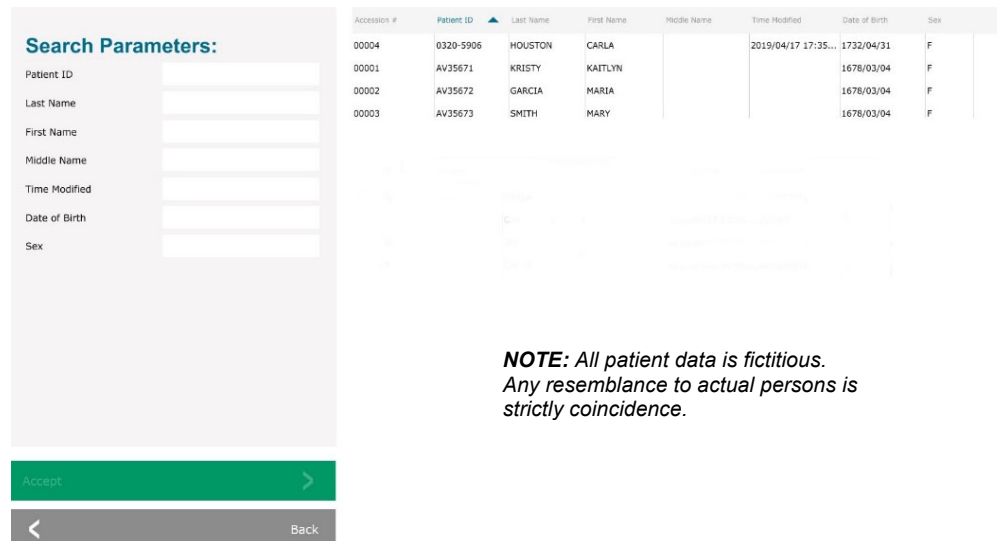

5.3.4 Select from Database

Figure 5.3.4
Selecting Patient from Local Database Entries

NOTE: All patient data is fictitious. Any resemblance to actual persons is strictly coincidence.

The user selects patient from the table on the right side of the page and then clicks on the **Accept** button which opens the Image Information Editor. (**Note:** The user may also double click the entry in the table to open the Image Information Editor.) Then follow the procedure and notes on page 5.7.

Note: Use the scroll bar at the bottom of the screen to view hidden patient information.

Vision allows the user to narrow the patient list by entering specific information in the “Search Parameters” window on the left side of the page. Only those patients matching all search parameters will be displayed.

If the user wishes to change or view the information after it has been input, but before an image has been taken, they may press the **Patient Data** icon in the top left corner. See Figure 5.3.5.



5.3.5 Patient Data Icon

Figure 5.3.5
Patient Data Icon

The Patient/Imaging Information Editing window will open. This editing window will be populated with all the information that was previously entered/selected. See figure 5.3.6. Note: The Editing window will now include a **Cancel** button.

The user can change or add information as desired then click on:

- The **Accept** button to save the changes and continue to image acquisition.
- The **Cancel** button to cancel changes and continue to image acquisition. The software will revert to the original patient information entered, or
- The **Start a New Patient or Procedure** button which will return the user to the Patient Data Entry Screen. See Figure 5.3.1.

Patient Information

Patient Name: * Jane Doe

Patient ID: * JD4567

Accession #: * 918273

Date of Birth: 1920/03/20

Sex: Female

Procedure Information

Procedure Name:

Laterality: * L

Position View:

Body Part:

Refer. Physician:

Technician:

Technician ID:

Study Information

Study Name:

Study ID:

Accept >

< Cancel

< Start a New Patient or Procedure

Figure 5.3.6
Image Properties dialog

Once the user clicks the **Accept** button the system is ready for image acquisition/x-rays.

X-rays are started by pressing the green **Start** button on the front of the Faxitron Path cabinet or clicking on the **Start X-Ray** button in the lower right corner of the screen. See Section 4.2.0, *Image Acquisition*. The system will take a short “sample” x-ray, or pre-shot (which is explained in Section 5.4.4) followed by a longer exposure to acquire the image. The software will process the image before it is displayed on the monitor screen. Once the image is displayed, buttons on the left and right side of the scree, covered throughout this section, will be enabled.

The user may view, but not edit, the patient information after acquiring an image by clicking on the **Patient Data** icon shown in Figure 5.3.5. This will display a modified Patient Information dialog box as shown in Figure 5.3.7. this box provides two buttons: **Close Dialog** or **Start a New Patient or Procedure**.

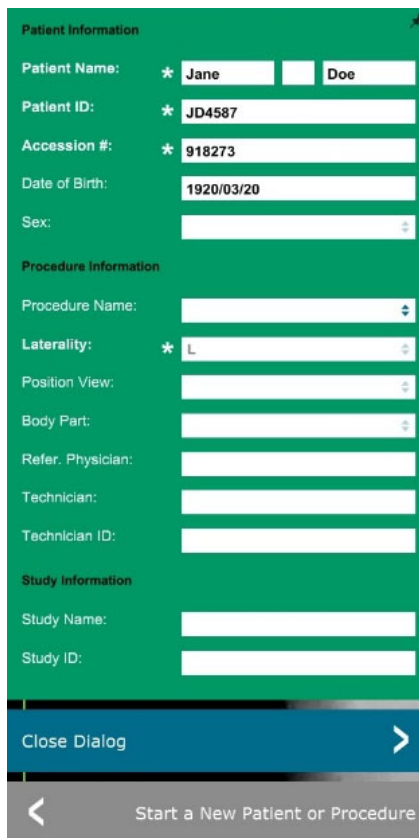

The dialog box is titled "Patient Information" and is divided into three sections: Patient Information, Procedure Information, and Study Information. At the bottom, there are two buttons: "Close Dialog" and "Start a New Patient or Procedure".

Patient Information	
Patient Name:	* Jane Doe
Patient ID:	* JD4587
Accession #:	* 918273
Date of Birth:	1920/03/20
Sex:	
Procedure Information	
Procedure Name:	
Laterality:	* L
Position View:	
Body Part:	
Refer. Physician:	
Technician:	
Technician ID:	
Study Information	
Study Name:	
Study ID:	

5.3.5 Cont.

Figure 5.3.7
Patient Information Dialog after Image Acquisition

Once an image is taken, the current image properties can be viewed by pressing the **(i)** icon in the top-right corner. See Figure 5.3.8. The Image Properties Dialog box will be displayed in the top-right corner of the image. The box is semi-transparent to allow one to see what's underneath the box. See Figure 5.3.9



Figure 5.3.8
Image Properties Icon

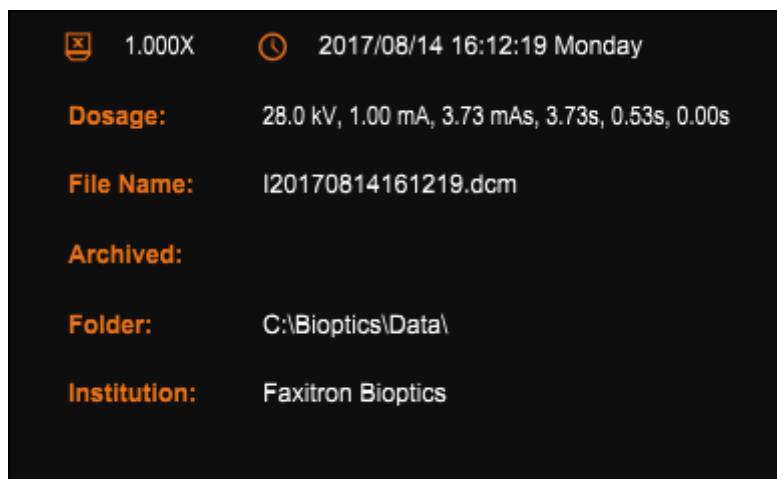

The dialog box displays the following image properties:

1.000X	2017/08/14 16:12:19 Monday
Dosage:	28.0 kV, 1.00 mA, 3.73 mAs, 3.73s, 0.53s, 0.00s
File Name:	I20170814161219.dcm
Archived:	
Folder:	C:\Bioptrics\Data\
Institution:	Faxitron Bioptrics

Figure 5.3.9
Image Properties Dialog (View Only)

Vision software provides various tools and menus to control various image attributes or parameters, x-ray acquisition, image views, image tools, and DICOM settings/access. The most commonly used tools are in a Tool Bar. The Tool Bar and Menus are described in more detail in the following pages.

5.4.0 Tool Bar and Menus

Vision software provides single click access to a number of commonly used tools or functions with a vertical tool bar located on the left side of the screen. More detailed descriptions follow in the next pages. See Figure 5.4.1.

5.4.1 Side Tool Bar

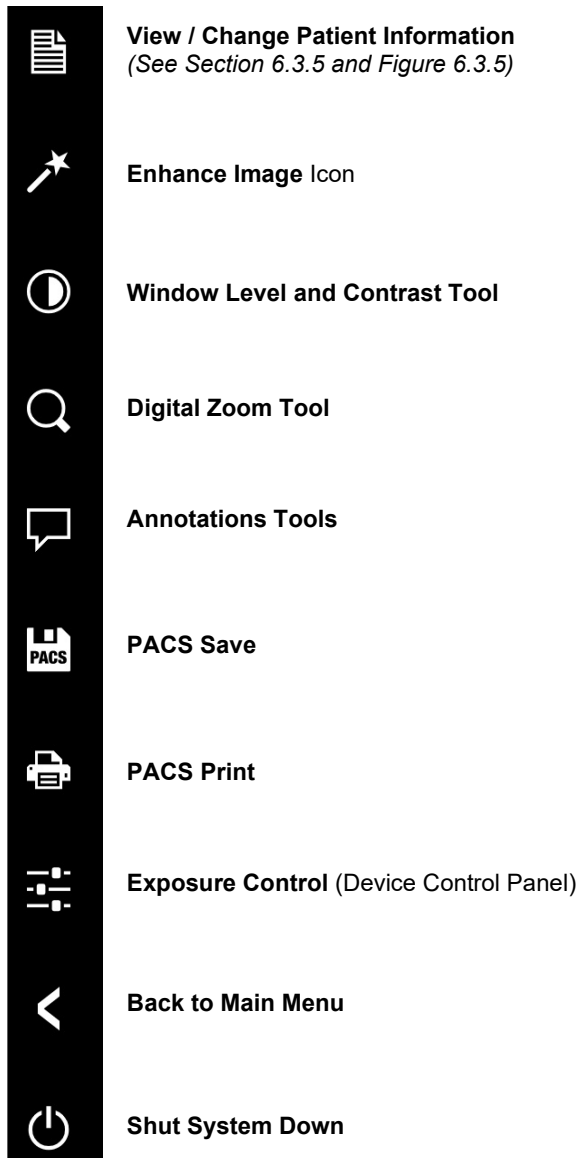

NOTES:

The following tools are always active in the image acquisition page:

- View/Change Patient Information
- Exposure Control,
- Back to Main Menu, and
- Shut System Down

The following tools will be disabled after patient data entry and will only be enabled after an x-ray image has been acquired:

- Enhance Image,
- Window Level and Contrast,
- Digital Zoom, and
- Annotation

The PACS Save and PACS Print tools are only enabled after an x-ray image has been acquired and when the system is connected to a PACS network.

Figure 5.4.1
Side Tool Bar

Enhance Image

5.4.1 Cont.

The button shown in Figure 5.4.2 will process the image on the display to emphasize the smaller details, such as micro-calcifications, and small masses in the image.



Figure 5.4.2
Image Enhancement icon

The algorithm, commonly known as “Peripheral Equalization” or “Thickness Equalization” in advanced imaging, is applied to the whole image. In addition to this algorithm, Faxitron employs a second, internally developed algorithm called the “Calcification Emphasis” algorithm. This secondary algorithm was made to bring out small details in the image and make them much easier to see and analyze.

Since Patient images constitute a more general category, in terms of possible geometries and variety of thickness, there may be some challenging sample geometries, and the user should use this tool with care.

The system will be idle (in Standby) during the processing. Once completed the button will stay depressed/active. The user can undo the process by pressing the button again.

Inverting, Window Level and Contrast Adjustment

5.4.1 Cont.

The button, shown in Figure 5.4.3, will open the Window Level and Contrast adjustment tool. This tool allows the user to adjust the image's window level and contrast. The user may also restore the Original Contrast by pressing the **Original Contrast** button, or invert the image by pressing the **Invert** button. Inverting flips the color scheme from being predominantly black to being predominantly white and vice versa. See Figure 5.4.4 below.

Figure 5.4.3
Window Level and Contrast Tool icon and Controls

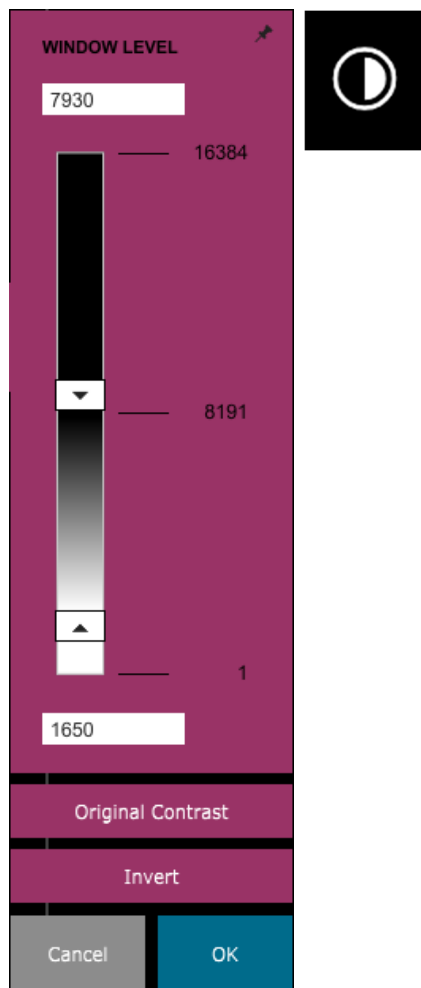

The user may also adjust the slider bar for desired image contrast by clicking on the bar and moving it up and down or by clicking on any of the indicated arrows on the bar to move the lower or upper window level limits. See Figure 5.4.3 (Informally this is also known as "Window Leveling.").

An example of inverting is shown below:

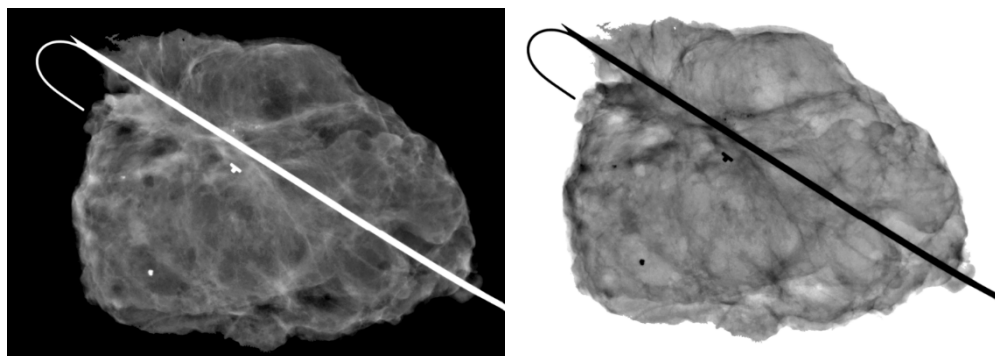

Figures 5.4.4
Example of inverting with the Adjust Contrast and Window Level tool

Dynamic Zoom Adjustment

5.4.1 Cont.

The Zoom Tool icon, *Figure 5.4.5*, will open the Zoom Adjustment tool. After opening this tool, the user may use the slider bar to adjust the zoom level, click the button to **Fit to Specimen**, **Fit to Screen**, or **Zoom 1.0x** (full resolution). See *Figure 5.4.6*. When the image has been zoomed in, panning is necessary to navigate around the image. A thumbnail dialog will appear in the top left corner of the screen, See *Figure 5.4.7* below. Click and hold the left button over the image and move the mouse to move the image around in the main screen.

Note that traditionally, this feature is also called "Pan View" and/or "Pan and Scan."



Figure 5.4.5
Zoom tool icon

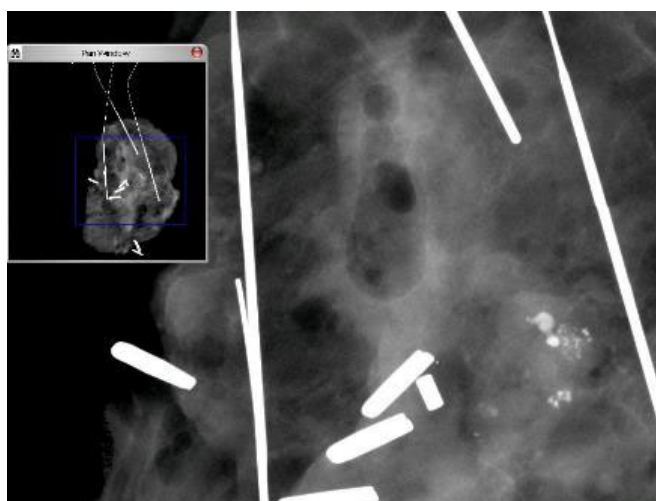

Figure 5.4.6
Zoom Level Adjustment tool

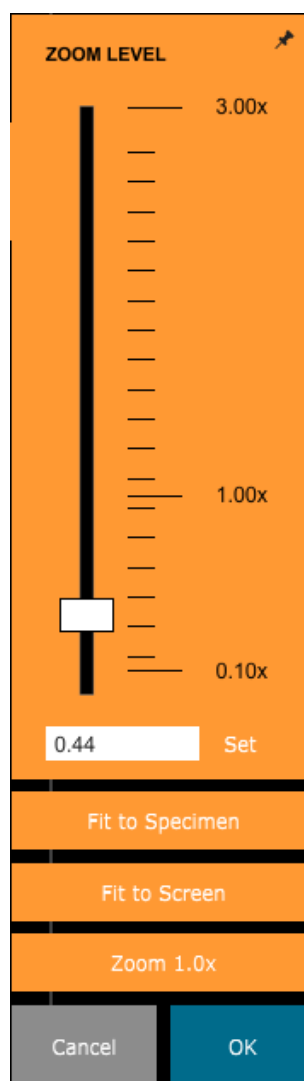

Figure 5.4.7
Pan View example (left)

The **Fit to Specimen** button will attempt to detect and zoom in onto the specimen as to ensure that the specimen is in full view. If a specimen is not detected, it will default to the previous mode (either "Fit to Screen" or "Zoom 1.0x").

Fit to Screen fits the image to the screen.

Zoom 1.0x is traditionally called "Full Resolution" as it brings the image to a 1-1 view with the monitor resolution.

Annotation

The button shown in Figure 5.4.8 will open up the annotation tools. These tools and their many features are discussed in further detail in section 5.8.0.



5.4.1 Cont.

Figure 5.4.8
Annotations icon

PACS Store

The button shown in Figure 5.4.9 will only function when the system is installed in a medical facility with a PACS network. To save your files locally, please refer to section 5.7.0.



Figure 5.4.9
PACS Store icon

PACS Print

The button shown in Figure 5.4.10 will only function when the system is installed in a medical facility with a PACS network. For local printing please refer to section 5.7.0.



Figure 5.4.10
PACS Print icon

Device Control Panel

The button shown in Figure 5.4.11 will open the Device Control Panel, which allows the device user the convenience of controlling the X-Ray system through the software. The user can easily select the Exposure Mode, X-Ray Tube kV settings, Exposure Time, and the number of images to acquire for Image Averaging (if desired) and initiate X-Ray exposure.



Figure 5.4.11
Back to Procedure icon

NOTE: The status, or availability, of the Exposure Settings is indicated by the up/down arrows adjacent to the setting. The arrows will be white for active settings and light blue of inactive settings. The Exposure Settings that are active is dependent on which Exposure Mode is selected.

Figure 5.4.12 to the right shows Full Auto mode has been selected and that kV, Time, and Image Averages are all active. The user can adjust each of these settings.

Note that the mA setting in the Faxitron Path system is not adjustable via the software. The mA settings will show as inactive.

When finished click on the **Request X-Rays** button to acquire an image, or the **Set** button to save the settings and close the Device Control Panel.

If the **Cancel** button is clicked the Device Control Panel will close without saving any of the changes.

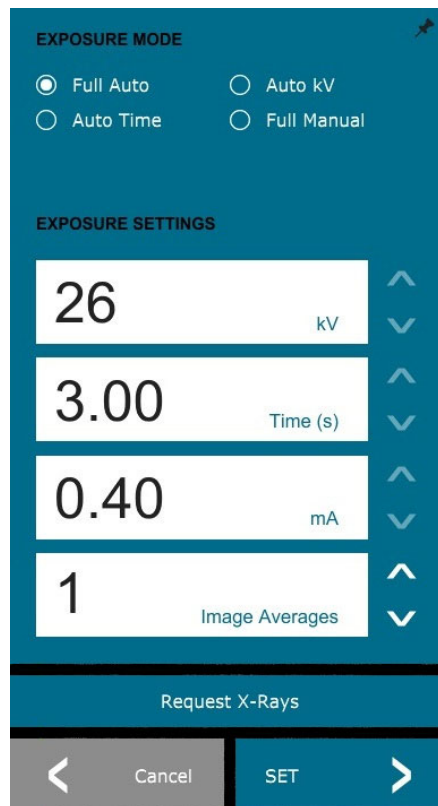

Figure 5.4.12
Device Control Panel

Back to Procedure

The button shown in Figure 5.4.13 exits the image acquisition mode and returns to the Main Menu screen.



5.4.1 Cont.

Figure 5.4.13
Back to Home Menu icon

Shutdown

The button, shown in Figure 5.4.14 will exit the software and shut down the system.



Figure 5.4.14
Shutdown System icon

Additional dialog notes

When a dialog is opened, it is “docked” to the left side of the screen. If a user wishes to un-dock the dialog box, they may click the top-right “Pin” icon to undock the dialog box and be able to drag the box freely. The “pin” then turns into a “X” icon allowing for quick closing.

Users can also quickly navigate between the various dialogs by clicking through the left menu. By doing so, the left menu will quickly close and open the applicable dialogs as appropriate.

Top Menu Bar

The software provides access to “View”, “Tools”, “Image Tools”, “DICOM Utilities” and “Help” menus through a Top Menu Bar. See Figure 5.4.15. The Top Menu Bar is hidden by default and is displayed by clicking on the **Arrow** button in the top right corner of the screen. See Figure 5.4.16. The **Arrow** button will be black or white depending on the software page/screen background. Each menu item is covered in detail in the following pages.



5.4.2 Top Menu Bar

Figure 5.4.15
Top Menu Bar

Note: The **arrow** will point down when the Top Menu is hidden and will point up when it is displayed.



Figure 5.4.16
Top Menu Bar buttons

View Menu

The “View” Menu is located in the top Main Menu and contains the sub0menu items shown in Figure 5.4.17 below. Each sub-menu item will be described in more detail in the following pages.

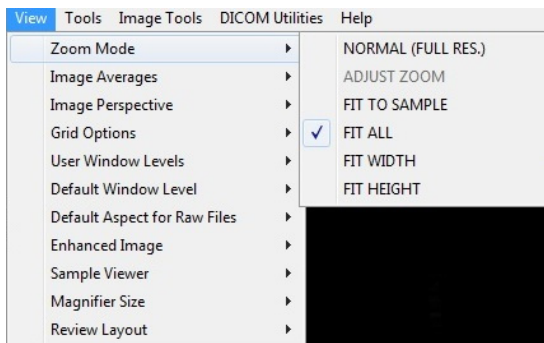

5.4.3 View Menu

Figure 5.4.17
View Menu

Zoom Mode

5.4.3 Cont.

Normal

Displays the acquired image in its native format. The image in Faxitron Path systems exceeds the monitors display area. A thumbnail dialog box will be displayed in the top left corner of the image which allows the user to “pan” the image. Refer to Dynamic Zoom Adjustment in Section 5.4.1.

Adjust Zoom

This option is greyed out and is not available at this time.

Fit to Sample

This option adjusts the acquired image to best fit the specimen sample within the monitors display area.

Fit All

This option displays the entire acquired image, regardless of its native format. The Full Resolution option does not work in this view mode.

Fit Width

This option displays the acquired image across the available width of the entire display area.

Fit Height

This option displays the acquired image across the available height of the entire display area.

Image Averages

This option allows the user to adjust the number of image averages to be taken per an exposure. The available options are 1x, 2x, 4x or 8x shots. Default setting is 1x Shots. If the user selects 2, 4 or 8 shots the software will acquire the number of images selected back to back with a single push of the **Start** button and average those images into a single image.

Image Perspective

This option allows the user to rotate the displayed image to 0, 90, 180 and 270 degrees in orientation.

Grid Options

5.4.3 Cont.

When an image is displayed, either as an acquired image or a retrieved image from the database, the user may activate a grid. Also allows the user to set grid spacing (pitch). See example below.

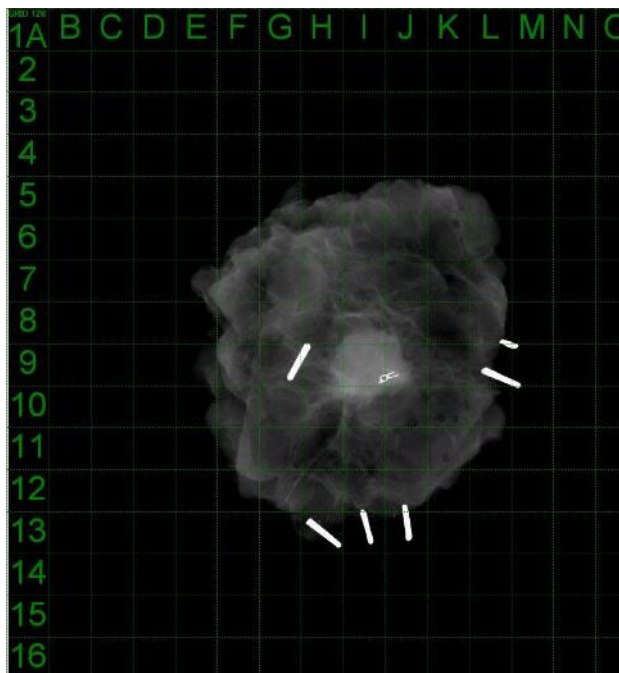

Figure 5.4.18
Sample grid display

User Window Levels

This allows the user to define up to three (3) pre-defined, user set Window Levels (WL). First select the **Window Level** button. Adjust the WL to the desired level. From the “View” tools, select the “User Window Levels”. Select “Record Current WL as USER WL #1, #2 or #3”. The adjusted WL will be saved under the choice previously selected.

Default Window Level

The user has two choices of “Default Window Levels” (WL). “Optimize for whole area”, which adjusts the WL for the entire image, or “Optimize for sample”, which adjusts the WL for under the sample area only. Additionally, there is an option to set the “Default Window Level” which is used for all obtained images located here as well. This will set the default window level based off of the image statistics and will need to be done for the un-enhanced and enhanced images separately.

Default Aspect of Raw Files

This tool is placed under the VIEW menu. It helps importing/opening of previously saved image files with unknown file attributes or binary image data without any header information. Since, exact imager array size is not available from header of image data file, a closest fitting imager dimensions will be used to import/open such images, based on width being larger or smaller than height (default aspect information).

Enhance Image (same as the Enhance Image Button)

Processes current Patient image and enhances visualization of tissue located near the periphery of the sample.

Sample Viewer

5.4.3 Cont.

In the event that the system has a web camera, this toggles the systems' web camera viewer to allow the specimen orientation and alignments.

Review Layout

Helps user configure multiple image panes in the Review (Database) Mode of program. Available options are “(1 X 1) Single”, “(2 X 1) Double H”, “(1 X 2) Double V”, “(1 + (2 X 1) Triple” and “(2 X 2) Quadruple” layout. During multiple pane operation, the user can click on desired pane/image once to make it current selection, the current selected pane will get green rectangular border around. The images in database list view or database thumbnail view will be opened into current selected pane when double click on them. User can also open the images into desired panes directly from right click menu of the mentioned database views After right click menu activated, the user can select from the panes listed under OPEN TO→ which will provide available panes to open the image into (left, right, top, bottom etc.).

Tools Menu

The “Tools” menu is located in the Top Menu Bar, found in the upper left hand corner of the main screen.

5.4.4 Tools Menu

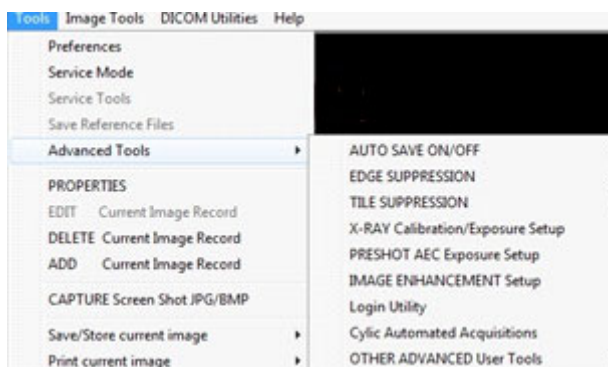

Figure 5.4.19
Tools menu

Preferences

The “Preferences” menu opens a configuration management utility which can be used to change various options or parameters.

NOTE: The “Preference” tool option is password protected and should only be accessed by an authorized Faxitron service representative.

NOTE: Changing configuration parameters without proper knowledge or authorization can cause loss of image quality, system damage, and system malfunctions.

Service Mode

The “Service Mode” is password protected and turned on by Faxitron authorized technicians for troubleshooting purposes.

Service Tools

“Service Tools” is normally greyed out. It is only turned on when the system is in “Service Mode”.

Save Reference Files

5.4.4 Cont.

“Save Reference Files” is normally greyed out. It is only turned on when the system is in “Service Mode”.

Advanced Tools Option

The Advanced tools offer various options to configure aspects of the software such as post-processing and configuration options.

Auto Save On/Off

When “Auto Save” is “on”, all subsequently acquired images are saved to the database. The files are written to a Data Directory defined in the configuration file.

X-Ray Calibration/Exposure Set-up

This is placed under Advanced Tools. The “X-Ray Calibration/Exposure Setup” aids the user in determining the proper exposure time for a selected kV setting for best image quality. Please refer to section 5.2.0 and 5.2.1 for a more detailed description.

Preshot AEC Exposure Setup

The Faxitron Path system utilizes Automatic Exposure Control (AEC) to provide the best possible image quality with a single press of the **Start X-Ray** button. The software utilizes a *Preshot* exposure to calculate the optimal exposure kV and time settings. The *Preshot* is a short, typically 2-3 seconds, x-ray exposure. The software analyzes the results to determine the kV and time needed to produce the best image quality. The Preshot AEC Exposure is configured at the factory and is turned on by default.

“Preshot AEC Exposure Setup” allows the user to adjust the system for particular imaging requirements or to compensate for system aging.

To access the “Preshot AEC Exposure Setup” dialog go to the Top Menu Bar, select “Tools”, “Advanced Tools” the “PRESHOT AEC Exposure Setup”. See Figure 5.4.19

Enter the PRESHOT AEC values in the window shown at right.

The settings shown reflect a 26 kV and 3 second exposure time with a target intensity of 10,000 ADUs for the pre-shot setting. Users can enter the selection of pre-shot parameters only with the selection of DYNAMIC METHOD in the ANALYSIS METHOD section. The STATIC METHOD selection will use Faxitron predefined parameters. In addition, the user has the option of selecting the kV and exposure time settings from the EXPOSURE TUNING METHOD section.

For more accurate images, the user can enter the SOFT TISSUE (Sample) thickness and the TARGET INTENSITY in ADUs. NOTE the values in the above image are an example only. The correct value needs to be determined.

Note: The values in the above image are typical for the Faxitron Path system. The exact values for your system need to be determined.

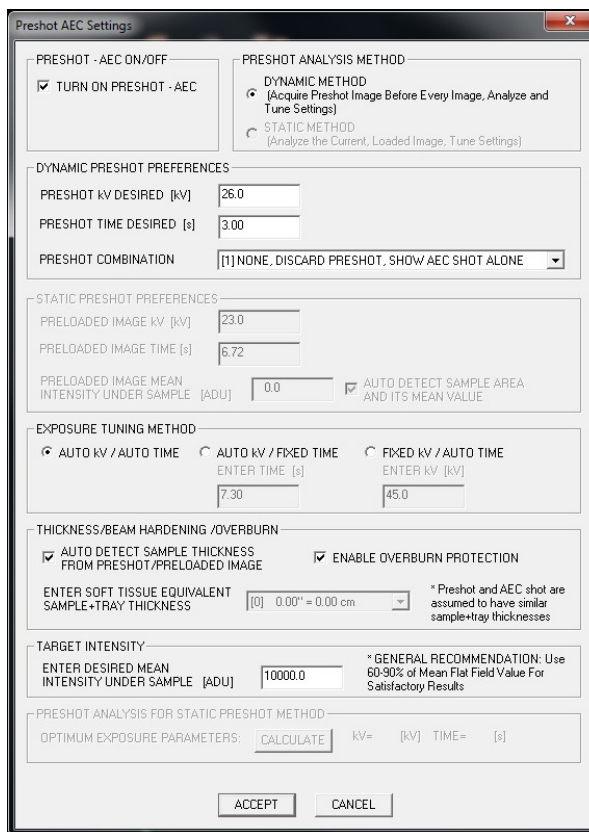

5.4.4 Cont.

Figure 5.4.20
Preshot AEC Setup dialog box

For the AUTOMATIC EXPOSURE CONTROL mode, push the **Start** button within the Vision software (or on the Control Panel). The Vision software will perform a pre-shot (a short, low dose, pre-exposure) of the sample to create a Region of Interest (ROI) for obtaining the exposure parameters for the optimum image exposure.

Login Utility

The Login Utility is under the ADVANCED TOOLS menu and allows the user to configure and activate the start-up password authentication for Vision software. Activation of this feature is optional on the Faxitron Path system. If the user activates the password authentication they will be prompted for the password each time the program is opened. The program will close if the correct password is not entered.

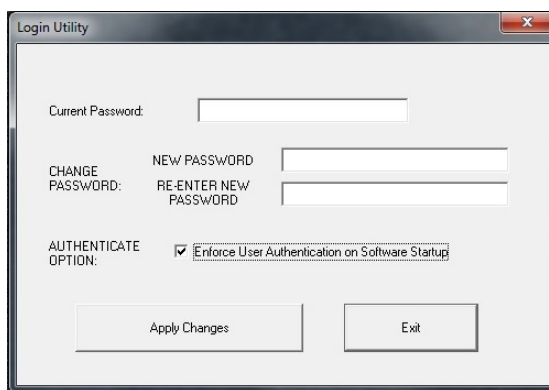

Figure 5.4.21
Login Utility. Same screen will appear during authentication at the startup.

Properties

5.4.4 Cont.

“*Properties*” hides or shows the Image Information Box. See Figure 5.3.9.

Edit Current Image Record

Currently not used.

Delete Current Image Record

Deletes the current image from the file directory as specified in the configuration file.

Add Current Image Record

Adds the current image to the file directory as specified in the configuration file.

Capture Screen Shot JPG/BMP

By selecting this menu choice, the user can do a screen capture of the displayed active window. The user can specify a file name and choose between JPG and BMP as the saved file format.

Save /Store Current Image

The user may “browse” to the directory or file folder to which the image is to be saved. A file name must be assigned in the field provided. Select a file type to save the image as. There are many file types provided. To save the file in a DICOM format, please refer to the “DICOM Functionality” section.

Print Current Image

Prints current image to the WINDOWS printer.

Image Tools

The following features are available to edit the acquired or retrieved image by clicking on the “*Image Tools*” menu. See Figure 5.4.22. The sub-menu options are activated or accessed with a single click on the desired option.

5.4.5 Image Tools



Figure 5.4.22
Image Tools Menu

Original Contrast

5.4.5 Cont.

“*Original Contrast*” restores the image contrast levels. This serves the same purpose as the **Original Contrast** button in the Window Level and Contrast tool. See Section 5.4.1 and Figure 5.4.3.

Invert

“*Invert*” causes the displayed image to become inverted or reversed. Inverting an image reverses its transparency: what is black becomes white and what is white becomes black. Grays are assigned their mirror transparency. Click “*Invert*” again to turn off the feature. Performs the same function as the **Invert** button. Refer to Section 5.4.1 and Figures 5.4.3 and 5.4.4.

Magnify

“*Magnify*” allows the user to magnify an area of interest. To use the Magnify feature, place the mouse cursor over the desired area to be magnified and click the left mouse button. The area of interest will be magnified. Click “*Magnify*” again to turn off the feature. Refer to Figure 5.4.23. The size of the magnified area of interest can be adjusted by the user. Refer to the “*Magnifier Size*” sub-menu in Section 5.4.3.

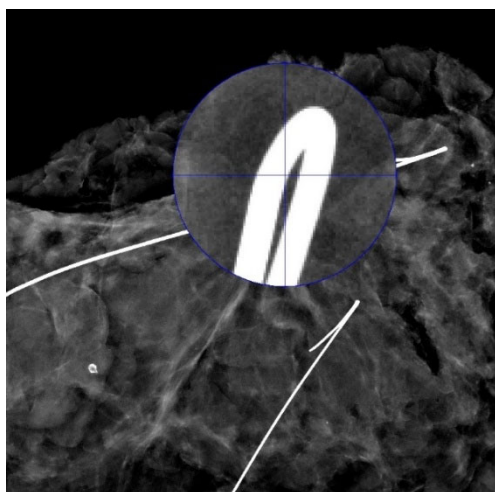

Figure 5.4.23
Magnify

Edge Enhance

“*Edge Enhance*” will create a sharper definition around edges of regions with a contrast difference. Edge Enhancement may amplify the noise in the images in general. Selecting the menu item again will turn off the edge enhancement. Clicking on “*Original Contrast*” will also restore the image back to its original state. Note this is a different feature than the Enhance Image feature in Section 5.4.1 and 5.4.3.

ROI Contrast

“*ROI Contrast*” will optimize the contrast levels within a user-defined region of interest (ROI). After selecting the “*ROI Contrast*” click and hold the left mouse button at the starting point of the desired ROI, drag the mouse and release the mouse button at the desired ending point of the ROI. The contrast will automatically adjust to the best levels for that ROI. (See the Definitions section for ROI).

ROI Window Level

the “*ROI Window Level*” function is not available in the current version of Vision software.

Ruler

5.4.5 Cont.

“Ruler” allows the user to measure the distance between two points in the displayed image. Length measurements are in millimeters (mm). After selecting “Ruler” click and hold the left mouse button, starting at the beginning point of measurement, drag the mouse and release the mouse button at the ending point of the measurement. The Ruler is displayed as a red line on the image.

The measurement (in mm) is displayed at the end of the ruler. The Ruler remains active until the user selects another image tool or until another action is performed. See Figure 5.4.24 to the right. Click “Ruler” again to turn off the feature.

Hint: To get a perfectly straight line, or a line at a perfect 45 degree angle, hold down the SHIFT key (on the keyboard) while holding down the left-mouse button and drag.

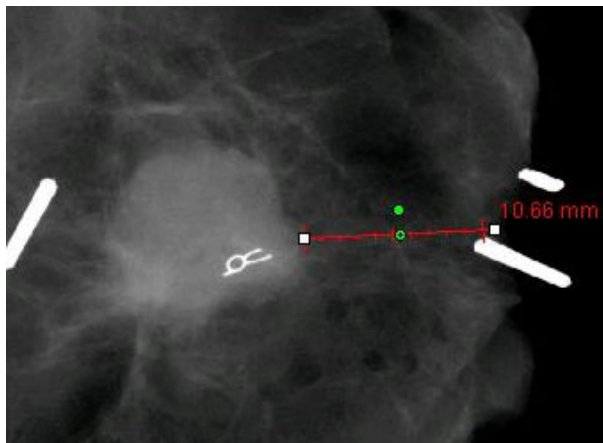

Figure 5.4.24
Ruler

ROI Statistics

“ROI Statistics” will display a dialog box containing image statistics. Click and hold the left mouse button over main image’s region-of-interest (ROI), drag cursor to make selection around area, and then release the mouse button. Statistical information for the selected region will be displayed on the left side of the dialog box and for the whole image on the right side of the box. The stats displayed are: the beginning and end points of the ROI, Minimum, Maximum and Mean intensity values, and Standard Deviation (STD). To close the Statistics information box, simply click on the **Close** button. See Figure 5.4.25. Click “ROI Statistics” again to turn off the feature.

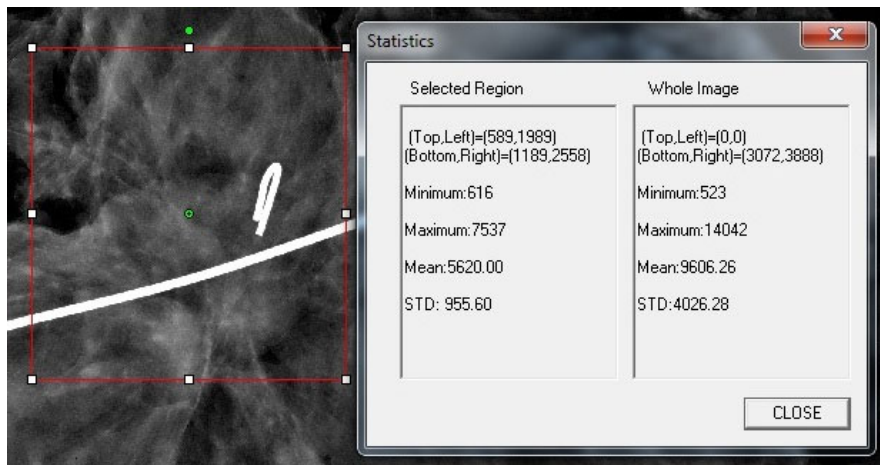

Figure 5.4.25
ROI Statistics

ROI Histogram

5.4.5 Cont.

“ROI Histogram” will create a histogram for a user defined ROI. After selecting the menu item, place the mouse cursor in the displayed image, press and hold down the left mouse button and drag the cursor to make the desired ROI selection. Release the mouse button. Histograms for the selected ROI will be displayed. See Figure 5.4.6.

The Black curve is the Histogram of the selected region. The Blue curve is the Histogram of the whole image. Both curves are normalized against the peak maximum pixel value of the selected region of interest. Click “ROI Histogram” again to turn off the feature.

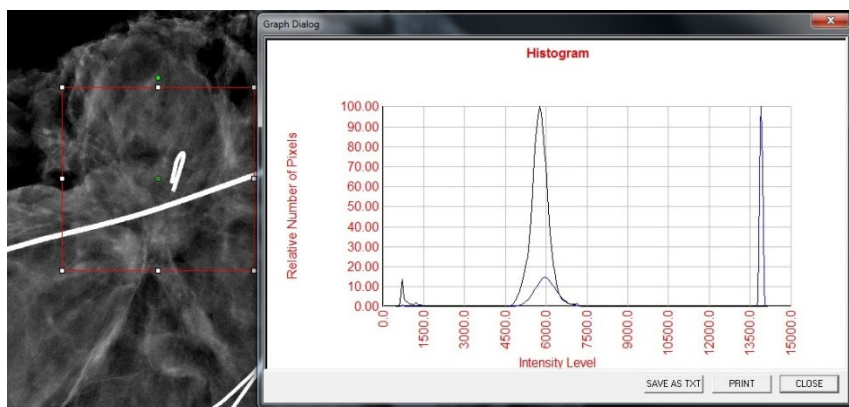

Figure 5.4.26
ROI Histogram

ROI Profile

“ROI Profile” will create a profile for a user defined ROI. After selecting the menu item place the cursor in the displayed image. Hold down the left mouse button and the move cursor across the image to draw a user-defined box around the desired ROI. Release the left mouse button and a profile will be displayed showing the individual pixel value of the defined ROI. See Figure 5.4.27. By default, the averaging direction of the selected ROI is the short axis. The axis may be toggled back and forth by selecting the **SWITCH, HOR<->VERT** button. Click “ROI Profile” again to turn off the feature.

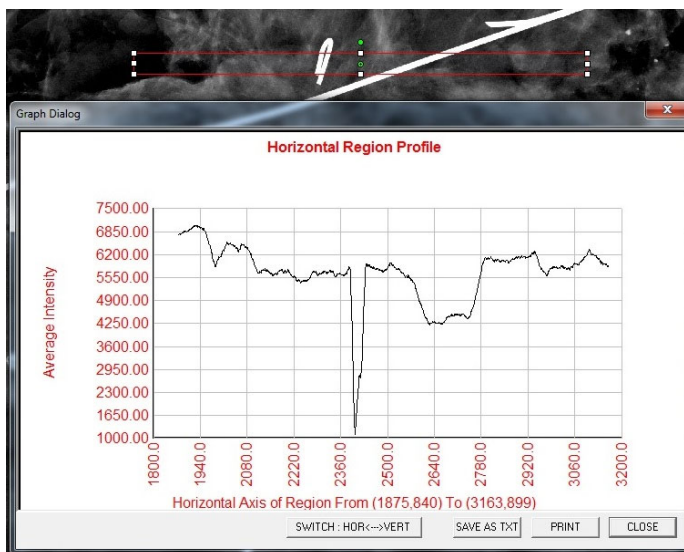

Figure 5.4.27
ROI Profile

Line Profile

5.4.5 Cont.

“Line Profile” will display a profile for a user defined line. After selecting “Line Profile” place the cursor in the displayed image. Hold down the left mouse button and move the cursor across the image to draw a user-defined line. Release the left mouse button and a profile will be given showing the individual pixel value of the defined line. See Figure 5.4.28. By default, the first selected point is always the left most (near origin) portion of the plot (i.e. horizontal axis of the graph can have increasing or decreasing pixel (i,i) indexes, depending on the selected start/end points). Click “Line Profile” again to turn off the feature.

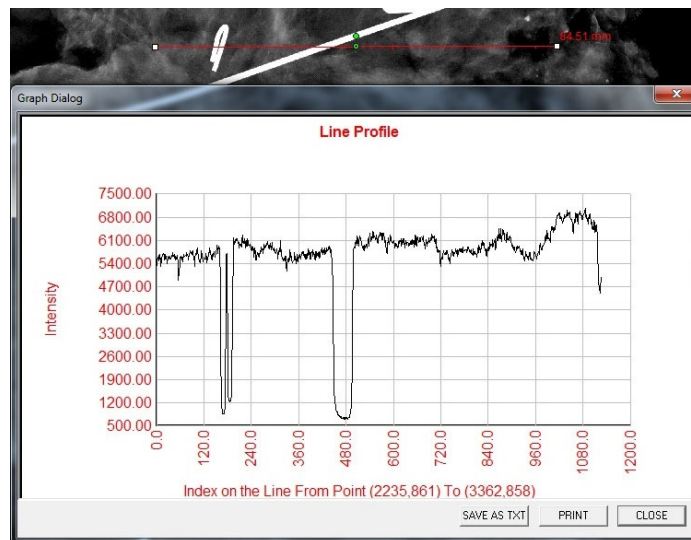

Figure 5.4.28
Line Profile

Built-In Window Level

Vision Software comes with a “built-in” Window Level feature. There is no button or menu item to select it. The Window Level feature is automatically activated whenever an image is acquired or retrieved from the database for review. This feature gives the user the ability to adjust the image contrast and brightness levels using the mouse/cursor.

Click and hold the left mouse button over the displayed image and move the cursor up and down for brightness/darkness levels or move the cursor left and right for low/high contrast. Move the cursor until image is at desired levels.

By pressing the button, shown in Figure 5.5.1, located along the bottom of the image acquisition window, the current patient images thumbnail strip appears. See Figure 5.5.2.



5.5.0 Current Patient Images Browser

Figure 5.5.1
Current Patient Images Browser icon



Figure 5.5.2
Current Patient Images Browser



Figure 5.5.3
Image Database button

The thumbnail strip displays the Procedure date for each individual image series in orange text along the top.

The current image displayed in the image acquisition window will be highlighted in green.

The thumbnail strip supports drag and drop operations to place images into the image display or review panes as necessary.

In addition, with a single click, the user can select multiple images and then select from the various options to Save the images to a USB drive, send the images to PACS, or delete the images. Selected images are highlighted in orange.

There are arrows located to the left and to the right. In the event of many images being taken, the user may traverse the images taken, date ascending, by pressing on the left/right arrows.

There is also an option to **Open the Database** (see Figure 5.5.3), which enters Review mode. This same button is the equivalent of pressing **Review Mode** from the Home Menu. See Figures 5.0.1 and 5.6.1.

Review mode can be entered by clicking the Review button in the Home Menu page, Figure 5.6.1 and 5.0.1, or the **Open** Database button in the Current Image Browser. See Figure 5.5.3. Clicking either of these buttons will open the Database as shown in Figure 5.6.2. The system will be in Standby while in review mode.

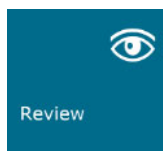

5.6.0 Database

Figure 5.6.1
Review Mode icon displayed on the Home Menu.

The Database is basically comprised of three sections or sub-windows. The Patient List Table section, on the left, the Procedure List Table section, on the top right, and the Image Thumbnail List/Viewer section, located bottom right.

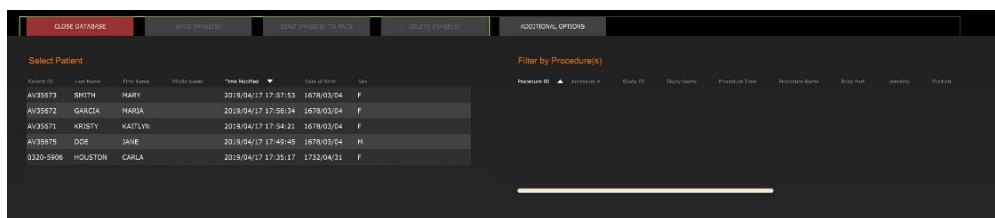

Figure 5.6.2
Image Database

The list tables work in top-to-down hierarchy as indicated by the arrow:

5.6.0 Cont.

The Patient List--->Procedure List--->Image Thumbnail List/Viewer.

The Patient selection window is the upper left most window. The Procedure window is the upper right most window.

When a Patient field is selected, the Procedure window becomes active. The Procedure window displays a listing of all Procedures performed under the selected Patient. Additionally, all images corresponding to the patient are displayed in the bottom right. It is not possible to select multiple patients.

When a Procedure is selected, the image thumbnail list/viewer is filtered to only show the images which correspond to the selected procedure. Multiple procedures can be selected by holding the Shift key and left-clicking each procedure. All the images for the selected procedures will be displayed accordingly.

- The database may have its sorting adjusted by clicking on the top fields such as Patient ID and Last Name to sort by either one. When the mouse cursor is clicked over one of the database fields, a small arrow indicator is displayed within the field. Using the Left Mouse button and selecting the field again changes the arrow from ascending to descending or vice versa. The field selected will be automatically sorted accordingly.
- Scroll bars are located in the database to allow for ease of navigation.
- The thumbnail list/viewer allows for a user to click on the "+" symbol to automatically add the image to a review pane. A user may add up to four images into the review panes. The review panes are automatically adjusted to encompass the four images.
- The same options as available in the Current Patient Images Browser (see Figure 5.5.2) are also located at the top of the Database. However, additional options are also made available, described in section 5.5.2.

Important Note: The "thumbnail" images (.PNG) are separate files from the actual image data (DCM, DAT, DMM, RAW) files. They have the same file name as the image file, but they have a (.PNG) file extension. It is possible to have an image file and no "thumbnail". In that event, Vision will attempt to create a thumbnail automatically for the image to be loaded into the database. However, if this is unsuccessful, the image will not be displayed.

Save Image(s)

The **Save Image(s)** button is available when an entry from the Image Table or Thumbnail List is selected, or through the current patient images, otherwise it is disabled. The selected image can be saved in the following popular 8-bit formats: JPEG, BMP, TIFF and RAW. It can also be saved in 16-bit TIFF format.

The window level of the saved image is the default window level. If the user requires that the window level be arranged, he/she should load the image to the Image View and print from there rather than printing from database dialog.

Send Image(s) to PACS:

This function sends the image(s) to a pre-configured DICOM PACS Server. Refere to Section 5.7.0 for more information.

Image Database Menu Functions and Tools

There are functions to navigate, search in the database, and to edit, delete, and add records to the database. Those functions are explained through database menu items. They are accessed from the top level button labelled **Additional Options** within the database.

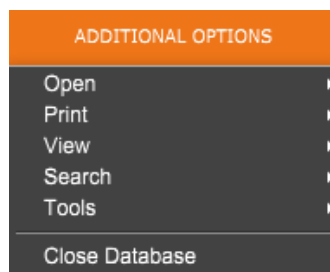

5.6.1 Database Additional Options

Figure 5.6.3
Additional Options Menu

Open Menu

The “Open” Menu has only one option “Open Image from File” which opens a Windows dialog box that allows the user to navigate to and open image files located on local or network drives.

Print Menu

The “DB-PRINT” menu provides for Image/Procedure/Patient print functionality. See Figure 4.6.4.



Figure 5.6.4
Database Print Menu

Print Image to Local Printer

“Print Image to Local Printer” is available when entry from the Image Table or Thumbnail List is selected, otherwise it is disabled. The selected image will be printed using the local default printer of Windows system.

The window level of the printed image is the default window level. It is not recommended that users Print from this menu, unless they are satisfied with the print outs set to the default window levels as calculated by the program. The user can load the image first into the Image View (Review) window and then adjust the image to the desired window levels. When satisfied with the window level, the user can then initiate Print from the menu of Image View window. A Format Options dialog provides a choice between printing formats.

Print Image(s) to DCM Printer

This function sends the image(S) to a pre-configured DICOM printer.

View Menu

The “View” Menu provides the user a number of options affecting the Database view. See Figure 5.6.5

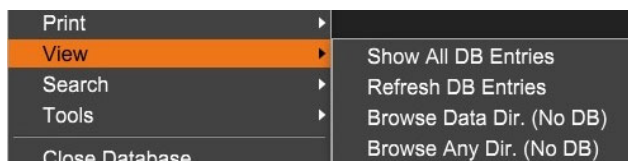

Figure 5.6.5
Database View Menu

Show All DB Entries

5.6.1 Cont.

Reloads the Patient table from the Database file. Any new changes or additions to the Database will be applied to the table. This selection also clears any active Search Filter which may have been applied to the tables. Search Filter is explained in detail under the Database Search subject below.

Refresh DB Entries

Refreshes the Patient table, but maintains any existing Search Filter that has been applied.

Browse Data Directory (No DB)

Displays all thumbnail images in the Data directory established by the configuration file. These files are displayed in the Thumbnail Viewer. They are not associated with the Database, or table lists. This tool is helpful to review un-recorded images, or to debug database problems with images in the current data directory.

Browse Any Directory (No DB)

Allows user to browse to any file directory. These files are displayed in the Thumbnail Viewer. They are not associated with the Database, or table lists. This tool is helpful to review an image directory which was never recorded in the database, or when database records are corrupted.

Search Menu

The database “Search” tools, *see Figure 5.6.6*, provide detailed searches or database filtering. Selecting the “DB-Search” menu allows the user to perform a detailed and specific search. When search criteria is entered and activated in the DB Search Dialog, *see Figure 5.6.7*, the search filter is applied to all list tables on Image Database dialog. The activated search criterion is called “Search Filter” and this filter remains effective until the user selects “stop Search” from “DB-Search” menu or “Show all DB Entries” from the “DB-View” menu. The active “Search Filter” is always shown in the caption of Image Database dialog.



Figure 5.6.6
Database Search Menu

Start Search

“Start Search” opens the DB Search Dialog which allows the user to place an active Search Filter on the database. When the Search Dialog is opened, the Database page is closed and the software goes back to the Image Acquisition page. The Database page will reopen automatically after the Search Dialog is closed.

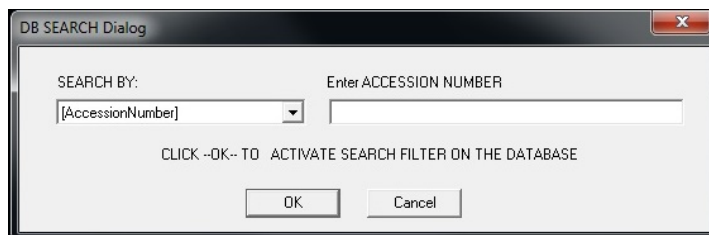

Figure 5.6.7
Starting a DB-SEARCH

Drop down menus provide a listing of the search categories. Select a search category and type in the desired search parameter to start the search. Select the “Start” to initiate the search. If the category can have more than one discrete entry, all entries for that category will be displayed.

Stop Search

5.6.1 Cont.

“*Stop Search*” disables any active Search Filter, clears all list tables, and re-loads the list of all Patients to Patient List Table.

Tools Menu

The “*DB-Tools*” menu provides per Image/Procedure/Patient functions as well as some useful functions to repair or reformat the database.

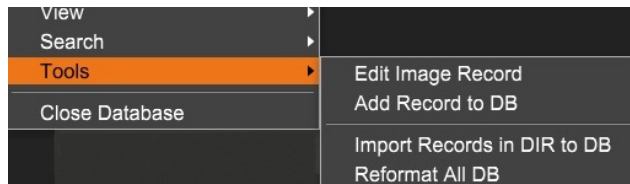

Figure 5.6.8
Database Tools Menu

Edit Image Record

The “*Edit Image Record*” function is not currently available in Vision software.

Add Record to DB

Available when entry from Image Table or Thumbnail List is selected, otherwise disabled. This is especially useful when a directory is browsed without database having entries available for images in that directory. The user can select a single image from the thumbnail list and add records of that image into the database. If the database entry already exists for the selected image it will not do any harm, it may only update the database in terms of where the image file is currently located i.e. file/folder name.

Import Records in DIR to DB:

This tool helps to browse and select a folder, and then to populate the database with all the corresponding entries for all the image files under the selected directory (including subdirectories). The formats for images can be DCM, DAT, DMM and RAW. If thumbnails or images are missing, this tool will also generate BMP thumbnails in the same directory.

Reformat All DB:

“*Reformat All DB*” tool helps to reformat Date [YYYY/MM/DD], Date/Time [YYYY/MM/DD HH:MM:SS] fields of tables, and also capitalizes letters of entries for some other fields. It is a useful tool when some older database file is imported and opened for the first time, or when the user alters database entries manually using MS Access.

Additional Notes on the Database

- The ability to Exit the database, staying within the Review mode, is located under **Additional Options**.
- The top-left button will adjust itself to take the user **Back to Acquisition**, **Back to the Main Menu**, or will become the **Close Database** button, dependent on the workflow used to enter the Database screen, and what is most appropriate.

Edit or Delete Patient Information from the Database

The user may edit or delete patient information from within the database. Right click on the patient's entry in the top section of the database to open a Dialog box. See Figure 5.6.9.

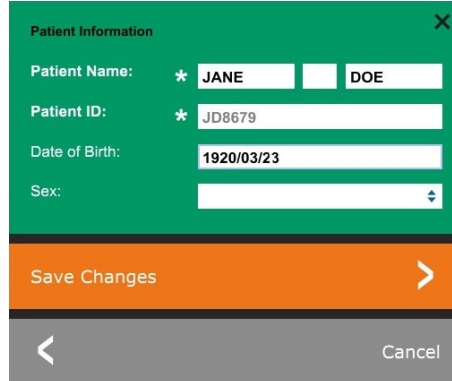
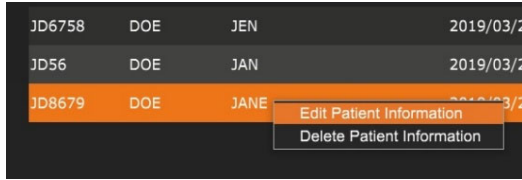

5.6.1 Cont.

Figure 5.6.9
Edit/Delete Dialog Box (Left)

Figure 5.6.10
Patient Information (Right)

Clicking on “*Edit Patient Information*” will open a “Patient Information” dialog box. See Figure 5.6.10. Click **Cancel** to return to the database without making or saving changes. Clicking **Save Changes** will open a “Confirmation” Dialog box.

Click **Yes** to confirm and proceed. Changes are now saved and the user will be returned to the database **No** will void the changes and return to the database. **Cancel** will return the user to the “Patient Information” dialog.

Note: If the system has a start-up password activated (see the Login Utility topic in Section 5.4.4 and Figure 5.4.21), the same password will be requested when trying to “*Delete Patient Information*” from the database.

The DICOM Standard What is the DICOM Standard?

The Digital Imaging and Communications in Medicine (DICOM) Standard is a series of protocols used by medical equipment and software to allow data to be compatible and interchangeable with other medical equipment or software.

When a file is saved in a DICOM format, a file is created that includes relevant Patient data, imaging equipment, hardware data, and image data, all in a single file. Additionally, the saved file contains specific characteristics that identify it to computer and software as a DICOM Standard file. Once a software application recognizes the file as a DICOM Standard file it can initiate a DICOM reader and extract the data properly, regardless of the file's origin.

A file created using the DICOM protocol has the following structure.

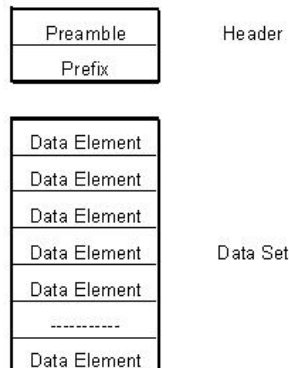

Figure 5.7.1
DICOM Protocol Structure

Where the Preamble consists of 128 bytes, all typically set to 00H unless it is not used by an Applicable Profile or a specific implementation; the Prefix consists of 4 bytes, making up the character string “DICM” encoded as uppercase characters of the ISO 8859 G0 Character Repertoire; and the Data Elements are arbitrarily large (or small) and contain the data.

5.7.0 DICOM Functionality

Modality

5.7.0 Cont.

The DICOM file settings for Modality are accessed from the Top Menu Bar by selecting “DICOM Utilities”, then “DICOM Modality Setup”.

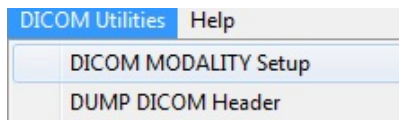

Figure 5.7.2
DICOM Utilities menu

The DICOM storage type, either Presentation or Processing may be selected. The same Dialog box allows for selecting the DICOM Image Modality, either Digital X-Ray or Digital X-Ray Mammography. The Transfer Syntax and Value Representation is not user definable. They are always assigned to be META HEADER PRESENT, LITTLE_ENDIAN and VR_IMPLICIT.

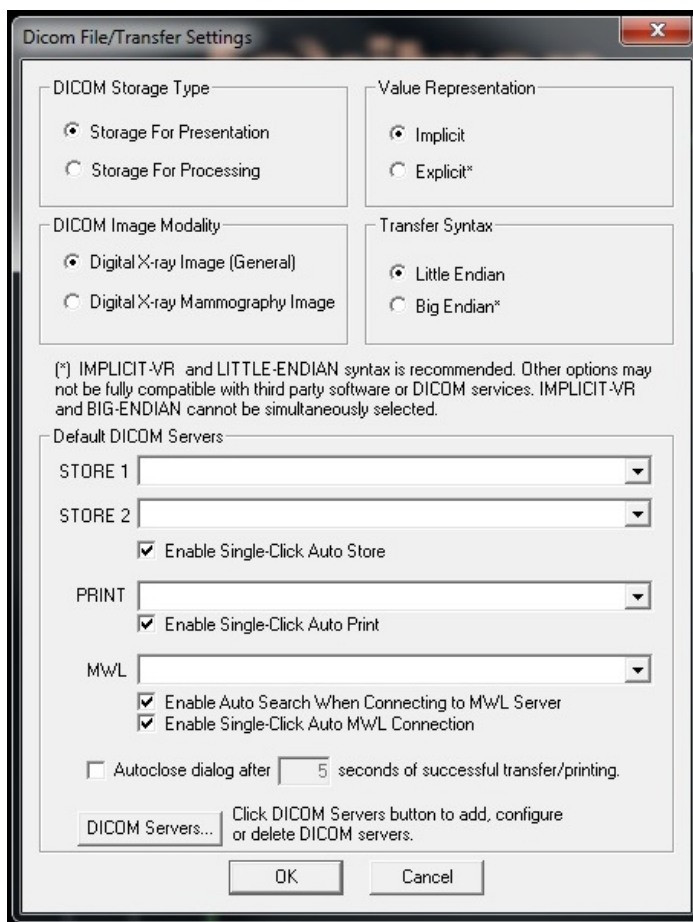

Figure 5.7.3
DICOM Modality Settings
Default settings shown

NOTE: Once the DICOM Modalities have been selected, they remain in effect even after the Vision software has been closed. The Modality settings are stored and will remain in the configured manner until they are changed again using the DICOM File Settings. These settings (Storage Type & Modality, Transfer Syntax, and Value Representation) will be effective for all DICOM Local Save or Print functionalities.

Default DICOM Servers

5.7.0 Cont.

This section contains settings for default DICOM servers and to automate some of the processes when storing, printing or searching PACS and MWL servers.

“Enable Single-Click Auto Store”, “Print” or “MWL Connection” checkboxes allow user to store or print images or automatically connect to the MWL server. If you use a single PACS server for those actions or majority of your work involves a single PACS server, check a desired box to automate those actions.

“Enable Auto Search When Connecting to MWL Server” will tell the application to automatically perform a search with default search settings when looking up patient’s data.

“Auto close dialog after N seconds of successful transfer/printing” will automatically close the DICOM Networking dialog after specified number of seconds passed. The dialog will not close automatically if there was an error with transfer or printing.

Clicking the **DICOM Servers** button will open DICOM Networking dialog, where a user can add, modify or delete DICOM servers. See Figure 5.7.5.

DICOM Save Local

To save the current image to a local drive/directory, right click anywhere in the image. This will display the dialog box shown in Figure 5.7.4 below. Click “Save/Store current image” then “As Local DICOM image”. This will bring up the standard Windows File Save Dialog. Browse or click through to the desired directly/folder, enter the file name and click **Save**.

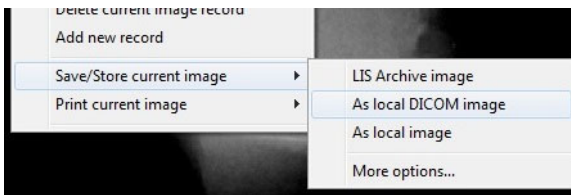

Figure 5.7.4
Save Current Image Dialog

PACS STORE and PACS PRINT

The Vision software allows for PACS (DICOM) Store and PACS (DICOM) Printing. These options are available throughout the software. For example, if the **PACS Store** button is selected, the following DICOM Networking Dialog window can be displayed. This Dialog box allows the user to do a DICOM Store, DICOM Print, or to Add, Modify or Remove DICOM Network connections or Peripherals.

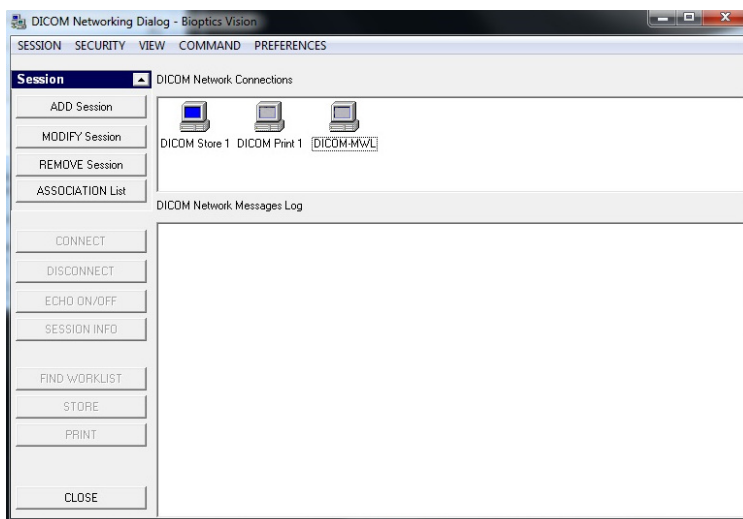

Figure 5.7.5
DICOM Networking Dialog box

PACS DICOM STORE

5.7.0 Cont.

The Vision software supports DICOM 3.0 C-STORE Service. This allows for sending an image or a series of images (under a specified Procedure) to a remote DICOM Application Entity (AE) compliant storage system such as PACS. Again, the DICOM Store capability is provided for throughout the Vision software. Modifications to the Presentation and Processing may be made through the DICOM Modality Setup, under the Tools menu.

Note: For DICOM Store, the “*SET FILM Attributes*” will be grayed out.

The user can add a new configuration for a remote DICOM AE to which to send the image or select from an already configured one, shown under the DICOM Network connections, in the DICOM Networking Dialog. By double clicking (or single click, followed by pressing the Connect button) the icon for the remote DICOM AE, the Vision software will connect and establish a DCIOM association with the selected remote AE. Once the association is successfully established, the image can be sent for storage by pressing the Store button. After the Store button is selected, the Vision software will send the selected image to the defined remote DICOM AE. If the Store operation is successful, the remote DIOCM AE will send a confirmation of reception and storage of the image(s). If the operation fails, the remote DICOM AE will send an error code indicating the reason for failure.

A single image can also be sent for storage by clicking the Right Mouse button on the image “thumbnail” while in the Database Browser and following the same procedure described previously. It is possible to send a whole Series (Procedure) of images for storage. This is accomplished by clicking the Right Mouse button on the Series (Procedure) name, displayed in the Database Browser screen and again, following the same protocol described above.

Add Session

The **Add Session** button opens the Session Dialog box through which the user can configure a new connection to a remote DICOM Application Entity.

To create a new connection configuration to a remote DICOM AE, the user must have the following information available: the Application Entity Title (AE Title), the choice of DICOM / PACS “function to perform”, the IP Address and the Port Number for the Server (i.e. the DICOM printer or PACS system).

The AE Title and Port Number of the user’s system (i.e. the client) are also required. Complete the appropriate data fields and select **OK** to create a new configuration.

Choosing DICOM / PACS Default Session Function Behavior

There are currently four (4) types of functions that a DICOM session can represent as a default. These are found in the Function drop-down list (combo box) seen in the figures below. A list also follows:

1. A GENERAL DICOM / PACS Connection
2. A DICOM STORE Connection
3. A DICOM PRINTER Connection
4. A Modality WORKLIST Connection

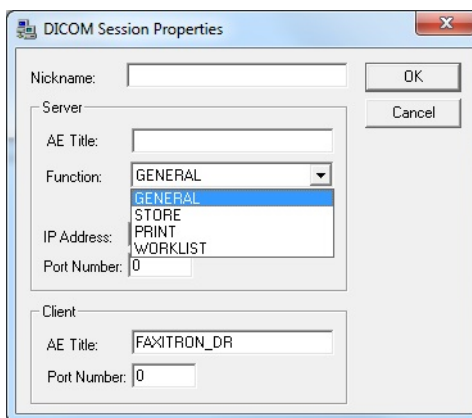

Figure 5.7.6
Session Properties Dialog box

The purpose of the DICOM “Function” is to allow a Session/Connection to be created (added) that allows a DICOM / PACS “device” to only be used as the user has configured it for a particular function category. Once configured, when you view or use the “DICOM Networking Dialog,” (see figure 5.7.5 above) only the icon that matches the function chosen will be “active and lit up.” That is, it will have a blue color as opposed to a “grayed out” color. For example, in figure 5.7.5 above, we have three (3) icons representing, in order, a PACS Store (DICOM Store 1), a PACS Print (DICOM Print 1), and a Modality Worklist (DICOM-MWL). Because the **DICOM Store** button was chosen previously it is the only one active (blue screen). It works the same for the other modes as well.

5.7.0 Cont.

Modify Session

The **Modify Session** button opens the Dialog box for the selected DICOM AE. In this window, the user may modify the Server and Client information described in the Add Session description.

Remove Session

The **Remove Session** button removes the selected DICOM AE configuration from the Vision software. Once removed, a DICOM AE configuration cannot be restored, unless the user manually re-enters the requisite data through the Add Session button. A confirmation of action will be requested, see below.

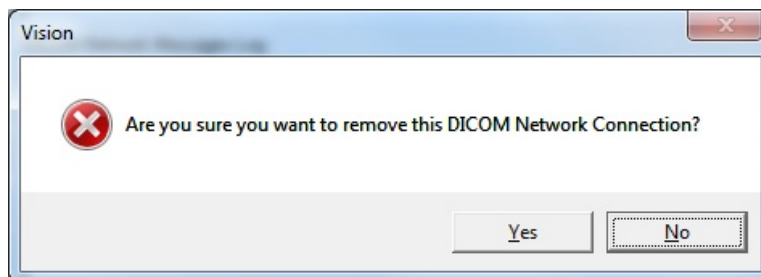

Figure 5.7.7
Verifying Removal of an Existing
DICOM Network Connection

Association

5.7.0 Cont.

The **Association List** button opens the Association Dialog box, depicted below, through which the user can edit the parameters and protocols used by the Vision software when negotiating a connection with a remote DICOM AE. These options should only be modified by an advanced user familiar with DICOM association protocols.

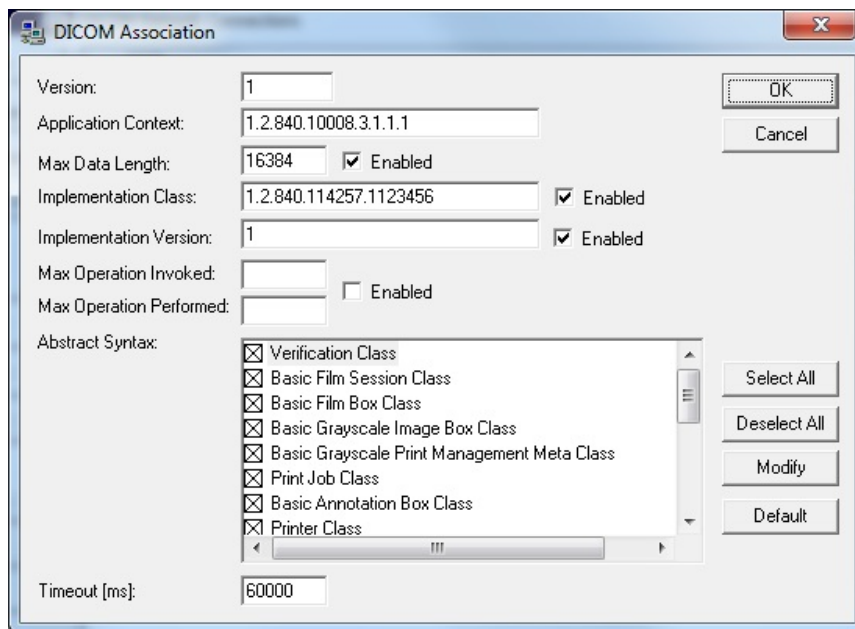

Figure 5.7.8
DICOM Association Window

Film Attributes

Selecting “Set DICOM Print Film Attributes” under the “Command” menu (Figure 5.7.9) displays the DICOM Printer Setup Dialog box. See Figure 5.7.10. In this Dialog box, the user may select various options governing the film and print format. Selecting **Default** restores all of the default options. Configurations to the settings are provided through drop down menus. To accept the modified configuration, select **OK**. To reject the options and exit the window without making any changes, select **Cancel**.

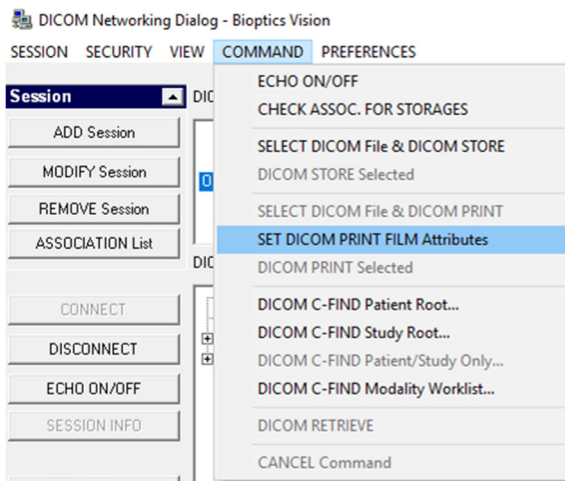
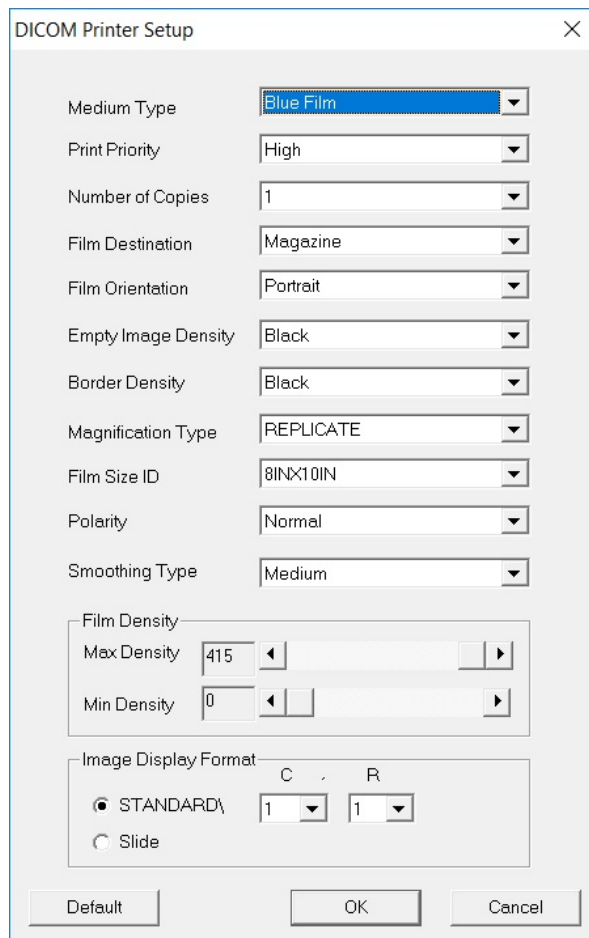

Figure 5.7.9
Set DICOM PRINT FILM
Attributes

5.7.0 Cont.

Figure 5.7.10
DICOM Printer Setup Dialog Box



PACS PRINT

The **PACS Print** option sends the selected image to the selected PACS DICOM printer. The image is printed according to the film and print format options found in the Set Film Attributes Dialog previously described. If the user initiates PACS Print from Image View, then the window level will be chosen from the Image View. If PACS Print is initiated from the Database Dialog, then the Window Level will be the default window level calculated by the Vision software.

Close

The **Close** button closes the DICOM Networking dialog box and returns the user to the area from which the DICOM command was executed. This command also closes the connection or association between the Vision software and the remote DICOM device if a connection was established.

Overview

User Annotations in the Faxitron Vision Software allows one to apply a transparent graphic “overlay” commonly call “annotations” to an image. These annotations take the form of text, lines, “free form” lines (Bezier curves), arrows, ellipse and boxes. This allows additional information and “markers” to be added to the image if desired. Note that all annotations can be easily turned on or off, in other words they can be shown or hidden at will.

5.8.0 User Annotations

Operations

To begin annotating, select the **Annotations** tool from the left menu. See Figures 5.4.1 and 5.8.1. By opening this dialog, the software will immediately put the user into design mode. It will also display a “Tool Pallet.” See Figure 5.8.2 below.



Figure 5.8.1
Annotation Icon

Selecting **Save** or **Cancel** from this dialog will either cancel the previous annotations or Save the current annotations to the window. It will also return you to normal imaging mode.

The tool pallet consists of fifteen (15) tool options that follow. However, the tools may be truncated based on the needs of the user to the most common 8 tools, which are displayed in the top row of the dialog box.

Note the behaviour of most of these tool options involve using the mouse to guide the on screen dynamic position and shape. Mouse “clicks” are used to set the final position and shape. The term “swipe” infers holding down the left-mouse button and moving the object around the screen. Letting go of the left mouse or clicking the right mouse button will “set” the annotations into a “permanent” or final position.

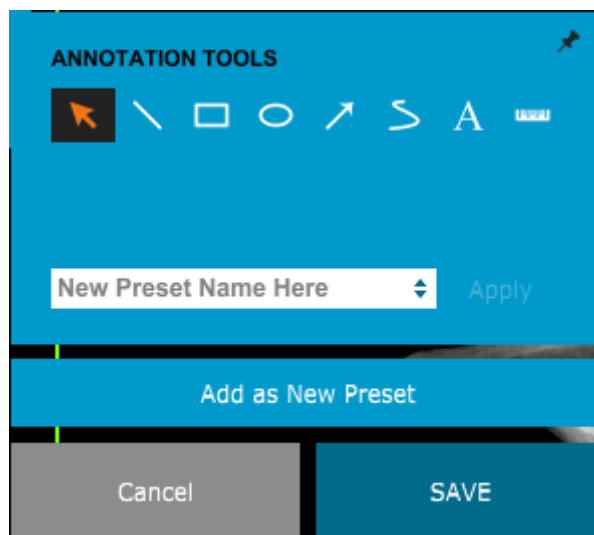

Figure 5.8.2
User Annotation Desing Tool
Pallet

Starting from the upper-left of the above figure a description follows of each tool options.

5.8.0 Cont.

- **Selection Tool:** Use this to select (highlight) a current annotation object. Click and hold the left mouse button down, which sets a starting position, then move the mouse around. Whatever annotations are inside the box being displayed will be selected for further use. Release the left mouse button to finish the operation.
- **Line Tool:** Draw a straight line with this option. Mouse behavior same as above.
- **Box Tool:** Draws a box. Mouse behavior same as above.
- **Ellipse (and Circle) Tool:** Draws an Ellipse or circle. Mouse behavior same as above.
- **Arrow Tool:** Draws a line with an arrow at the end. Mouse behavior same as Line Tool.
- **Polygon Open Line Tool:** Draws non-straight “open segmented” lines. Left-click mouse, hold button, draw. Release left button, this sets a line segment. Repeat as desired. Right-click mouse button and tool operation is complete.
- **Text Tool:** Creates a “textbox” where you can type text-based data.
- **Ruler Tool:** Creates a ruled line segment. Very much like the Image Tools Ruler feature.
- **Polygon Closed Line Tool:** Draws non-straight “closed segmented” lines. Left-click mouse, hold button, draw. Release left button, this sets a line segment. Repeat as desired. Right-click mouse button and tool operation is complete.
- **Curved Open Line Tool:** Draws curved “open segmented” lines. (Bezier curves.) Left-click mouse, hold button, draw. Release left button, this sets a curved-line segment. Repeat as desired. Right-click mouse button and tool operation is complete.
- **Curved Closed Line Tool:** draws curved “closed segmented” lines. (Bezier curves.) Left-click mouse, hold button, draw. Release left button, this sets a curved-line segment. Repeat as desired. Right-click mouse button and tool operation is complete.
- **Text “Balloon” Tool:** creates a textbox with a line segment protruding from a corner of the text box. This can be used to “link” text to something on your image.
- **Segmented Ruler:** Draws non-straight “open segmented” ruled lines. Left-click mouse, hold button, draw. Release left button, this sets a ruled line segment. Repeat as desired. Right-click mouse button and tool operation is complete. The length of all the ruled line segments is shown at the end of the ruler. Useful for a rough estimate of the periphery of an object or Patient.
- **Protractor Tool:** Draws an angle on screen and provides the degree of the angle. Just like a protractor.
- **Orthogonal Ruler Tool:** Provides two (2) ruled lines that are orthogonal to each other.

Design Mode and Mouse Right-Click Menu

5.8.0 Cont.

While in User Annotation Design Mode – but not in a specific operation mode – one can right-click the mouse and get a context sensitive menu. See below.

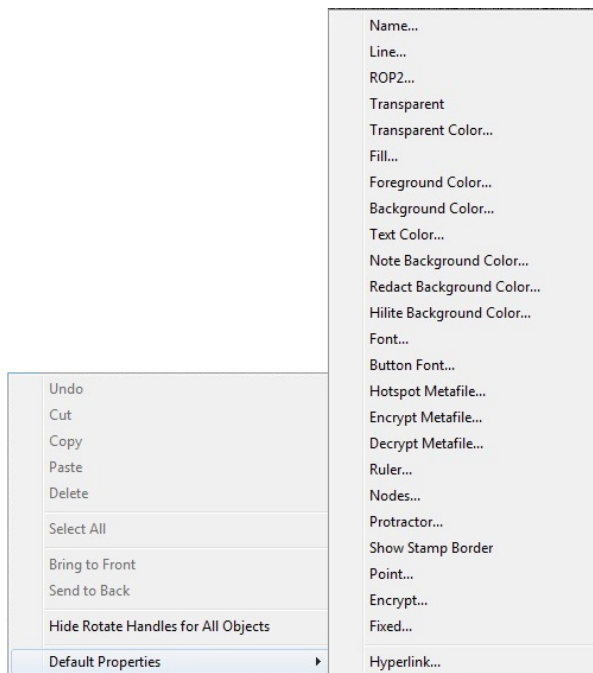

Figure 5.8.3
Right-click Mouse Context Sensitive Menu (Only During Design Mose of User Annotations)

Many specific settings can be made from these context sensitive menus.

Note: If an item seems too small to read or see correctly you can possibly change it from the Right click menus shown above. Alternatively, you can choose to zoom into the image using the Dynamic Zoom tool. This enlarges the image and you should be able to clearly see any annotation.

Show – Hide Annotations

The **Toggle Annotations** button, shown in Figure 5.8.4, allows users to quickly toggle annotations on and off. By default, the annotations will be toggled on. The button is located in the right-side menu near the upper right corner.



Figure 5.8.4
Show/Hide Option for User Annotations

The “Help” submenu, See Figure 5.9.1, is located on the top menu bar and provides quick access to the Faxitron Path User Manual and “About Vision”. Refer to 5.10.0 and Figure 5.10.1.

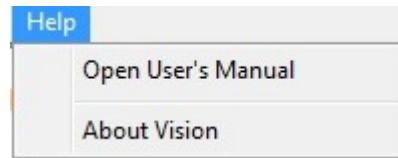

5.9.0 About Help

Figure 5.9.1
Online Help Dialog Box

The About Vision button opens a Dialog box that shows the Vision software version and copyright date and system information.

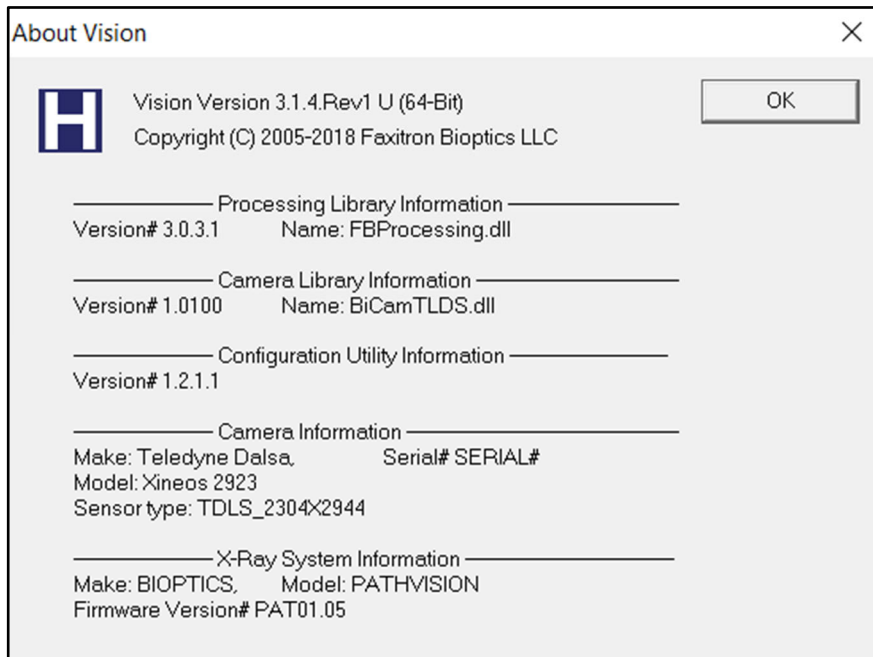

5.10.0 About Faxitron Vision Software

Figure 5.10.1
*About Faxitron Vision Information
Dialog Box*

6

SECTION 6
**Compliance Requirements
and Safety Measure**

Requirements | Faxitron Path Compliance

Emission Limits

Radiation emitted from the Faxitron Path unit does not exceed an exposure of 0.1 milli-Roentgen (mR) per hour at any point 5 centimeters (cm) outside the external surface. For countries requiring emission values measured at 10 cm from the external surfaces, the radiation does not exceed 0.1 mR per hour at 10 cm.

Safety Interlocks

Faxitron Path Specimen DR system has two safety interlocks on the specimen door.

Start Button

Following interruption of X-ray generation by the safety interlocks, the Start button on the front panel will resume X-ray generation when ready.

Key Actuated Control

Key Lock switch located on the front panel, which requires a key to be inserted and turned clockwise to the 3 o'clock position in order to provide power to the cabinet system. The key is captive in the "ON" position.

Emergency Stop Button

The Emergency Stop button on the Faxitron Path front panel is available to terminate the generation of X-rays. This is in addition to the safety interlocks on the system doors.

X-ray Generation Indicators

The Faxitron Path has an X-ray On indicator light on the front panel and graphical user interface, and also produces an audible tone when generating x-rays.

Power Ratings

100-240 50/60 HZ 200 W MAX.

Heat Output

500 BTU/hr MAX.

LASER LOCATOR

The Faxitron Path utilizes a pair of laser generated lines to aid in positioning samples in the middle of the imaging field.

Laser Parameters

Lasers comply with IEC 60825-1:2007

Class 2 Laser Products

Wavelength: 670nm

Peak Power: 2mW

Line Width: 1mm Typical

Beam Divergence: 85° Typical

The lasers require no assembly.

There is no authorized operator maintenance on the lasers. The lasers are to be serviced only by a Hologic Authorized Representative.

LASER ELECTRICAL PARAMETERS

Operating Voltage: Red: 3-6VDC

Black: Ground

Operating Current: 50mA Typical

80mA MAX

6.1.0

Compliance Requirements and Safety Measures

CAUTIONS:

CLASS 2 LASER RADIATION WHEN THE DOOR IS OPEN. DO NOT STARE INTO THE BEAM.

6.1.0 Cont.

A laser beam can be damaging to the eyes, DO NOT look into the laser aperture when the laser is in operation.

Be aware that laser light can also be dangerous when reflected off a mirror-like surface.

For further safety information regarding lasers, refer to ANSI-Z1 36.1 STANDARD FOR THE SAFE USE OF LASERS, available from the Laser Institute of America, phone 407-380-1553.

NOTE: The laser apertures are located in the ceiling of the X-Ray chamber.

Laser CAUTION Label: Located on upper right corner of door.



DICOM Version

6.2.0
DICOM Standard

Faxitron uses the latest DICOM standard:
ACR-NEMA Digital Imaging and Communications in Medicine (DICOM) v3.0, Final Draft, Aug. 1993.

And complies with:
NEMA PS 3.1 - 3.20 (2016), Digital Imaging and Communications In Medicine Set

Storage Classes

FAXITRON_DR provides Standard Conformance to the following DICOM V3.0 SOP Class as a SCU.

SCU SOP Class

SOP Class	SOP Class UID
Computed Radiography Image Storage SOP	1.2.840.10008.5.1.4.1.1.1
Digital X-ray Image Storage Presentation	1.2.840.10008.5.1.4.1.1.1.1
Digital X-ray Image Storage Processing	1.2.840.10008.5.1.4.1.1.1.1.1
Digital X-ray Mammography Image Storage Presentation	1.2.840.10008.5.1.4.1.1.1.2
Digital X-ray Mammography Image Storage Processing	1.2.840.10008.5.1.4.1.1.1.2.1
Study Root Query/Retrieve Info. Model -FIND	1.2.840.10008.5.1.4.1.2.2.1
Patient Root Query/Retrieve Info. Model -FIND	1.2.840.10008.5.1.4.1.2.1.1
Modality Worklist information Model-FIND	1.2.840.10008.5.1.4.31
Greyscale Softcopy Presentation Storage	1.2.840.10008.5.1.4.1.1.11.1

For further details refer to the full DICOM Conformance Statement stored on the system. The file is in C:\Faxitron and a shortcut is provided on the desktop.

If required, a copy of the DICOM conformance statement is available from Faxitron on request.

7

SECTION 7
**Service and
Troubleshooting**

Service

There are no serviceable parts in Faxitron equipment. Please contact your authorized Hologic representative for servicing.

USA: +1.877.371.4372
Europe: +32 2 711 4690
Asia: +852 37487700
Australia: +1 800 264 073
All Other: +1 781 999 7750
Email: BreastHealth.Support@hologic.com

7.1.0 Service and Troubleshooting

Troubleshooting

Computer or System will not turn on

No power to the computer or x-ray system.
Verify power to system is ON and power strip is plugged in and ON.

READY light does not stay "on"

Button was pressed BEFORE Vision Software was running or before software armed the x-ray system for an acquisition. See **Quick Start**.

Image looks like there is another object in x-ray

Verify that during "Calibration" that there were no objects in the X-ray cabinet. Remove objects and repeat **Calibration**.

Poor image quality

Verify that the image intensity values ($I(x,y)$) found in the lower Right-hand corner of the image display window are near 10000 ADUs when preshot AEC target is also set to 10000 ADUs and exposure mode is selected as Auto kV/Auto Time. If needed, repeat the **Imaging** procedure.

Cybersecurity

If a cybersecurity event occurs disconnect the system from the network and contact Faxitron immediately. We will work with your IT department to resolve the issue.

A cybersecurity event can be detected in a number of ways:

- Slower than normal operation and/or network connection
- Suspicious pop-ups or home page changed in internet browser
- Password(s) no longer working
- Unidentified programs in start menu or system tray
- Missing, corrupt or altered data

8

SECTION 8
**Schedule of
Maintenance**

This document provides a schedule of testing and maintenance for the Faxitron Path. It is strongly recommended that the maintenance and tests described in this section be performed at the intervals of time indicated to ensure that your Faxitron X-Ray generator continues to operate at optimal performance.

8.0.0 Maintenance

Warning: Samples containing tissue can harbor infectious agents that are hazardous to your health. Follow appropriate biosafety procedures; wear gloves when handling tissue specimens or any materials with which they come in contact.



8.1.0 Internal

Periodically wipe down the interior of the cabinet with 70-90% isopropyl alcohol or diluted sodium hypochlorite (5.25%-6.15% household bleach diluted 1:500 provides the proper concentration). Ensure the specimen area, marked on the chamber floor, is thoroughly cleaned.

Do not use acetone or other harsh/aggressive solvents on the x-ray chamber door window.

Periodically wipe down the exterior surfaces with isopropyl alcohol, sodium hypochlorite, or mild soap and water. (See 8.1.0 above for appropriate concentrations.) Do not drench or flood surfaces and do not use abrasives which may scratch surfaces. Do not allow any moisture to contact any of the systems electrical components. Test cleaning agents on a small inconspicuous area of the plastic and metal covers to verify they will not damage the finish.

8.2.0 External

Except for External Cables and Fuses – the system has no user replaceable components. The following items can be ordered and replaced by Faxitron staff or approved representatives.

8.3.0 Replaceable Parts

- Digital X-Ray Detector
- PCIe interface Card
- Computer, Monitor, Mouse and Keyboard
- Controller PCB
- X-Ray Tube and HV Power Supply
- Low Voltage Power Supply

- Acrylic Scattering Target (0.25"~ 6mm and 1" ~ 24 mm thick)
- ACR Phantom (Nuclear Associates P/N 18-250)
- Ion chamber Survey Meter, Inovision Model 451B-DE-SI-RYR or similar
- 1 gallon (4 liter) plastic jug of water

8.4.0 Materials Needed

The following references provide information that amplifies or augments the software safety procedures, which are defined in this document.

Safety & Cybersecurity

Any software or firmware updates that have been released since the last maintenance that resolve a safety or security issue can be provided, as necessary.

The firmware is hard coded into the control board so if a firmware update is required, replace the control panel PCB.

8.5.0 Reference Documents and Version Information

The following definitions apply for the terms listed below when referenced in this Schedule of Maintenance.

8.6.0 Definitions

ACR Phantom- American College of Radiology Accreditation Phantom.

ADU- Analog-to-Digital Units.

AEC- Automatic Exposure Control - Computer terminates x-rays when enough signal has reached the detector.

Contrast: Percent of difference between object intensity and background intensity.

Dark current: Thermally generated signal in the sensor; (almost) linear with time.

Flat-fielding: Gain and offset corrections performed on a pixel-by-pixel basis. Each pixel has a different gain and offset and must be calibrated out.

Line pairs per millimeter: Number of alternating lead and air pieces. For example 10 lp/mm means => {air/lead} {air/lead} ... 10 times in one millimeter.

Magnification: Moving the object away from the detector and towards the x-ray source to magnify the image of the object on the detector.

MTF: Modulation Transfer Function. A measurement of the contrast and resolution of an imaging system.

Read noise: RMS noise measurement in 0-second dark exposure (no signal).

ROI: Region Of Interest. Generally a specific sub-region of an image.

SID: Source-to-image distance; distance from the x-ray source to the detector.

Specimen Radiography: X-ray imaging of a piece of tissue after it is extracted from the body.

Periodic maintenance should be performed annually to ensure your Faxitron Path system continues to perform optimally over time. This periodic maintenance includes verification of the following:

8.7.0 Periodic Maintenance

- Safety Interlocks and Indicators, Section 8.8.0,
- ACR Phantom Test (verifies camera performance), Section 8.8.1, and
- Radiographic Survey, Section 8.8.2.

We recommend these procedures be performed annually, however government regulations may require more frequent maintenance schedules.

Interlocks, Lights, Error Messages – To be performed annually

Print this page to use as reference if needed.

Record results under “Safety Interlocks and Indicators” on the Periodic Maintenance Record – Faxitron Path, located at the end of the Section.

8.8.0 Safety Interlocks and Indicators

1. System must be powered on. The key lock switch should be in the 3 o'clock position with the key captive.
2. Verify the “Power” led comes on. No other LED is illuminated at this time.
3. Verify the LCD screen illuminates and displays “System Idle” and there are no other messages, such as “Door Open” at this time.
4. Open the specimen door. The LCD screen will display the message “Door Open”. When the door is closed, this message should disappear.
5. Turn the computer and monitor “ON”. Vision software should automatically start. If the software doesn't automatically start, double-click the Vision Software icon to start the imaging software. If this initiates a calibration, allow the calibration to fully complete.
6. Next, Click the Start Procedure button, then click the Patient Data button, and choose the Enter Manually button to access the patient entry screen. Fill all fields marked with an asterisk (*), and click the “Accept” button. This will allow for an exposure to be taken.
7. Verify that the “Ready” LED is on. The LCD will also display a “Ready” message.
8. Press the green “X-ray” button on the front of the Faxitron Path. The system should begin taking an x-ray exposure. Make sure the LCD screen displays the bar indicator for the exposure, as well as the exposure kV and time. Also check that the “X-Ray On” LED comes on. You should also hear an a short beep about once per second during the exposure. Let the exposure finish and make sure the image shows up on the computer screen.
9. Press the green button again to start another exposure. While the exposure is taking place, press the red “Stop” button and the exposure should stop within 2 seconds of pressing the button. Most notably the buzzer will stop sounding to indicate the exposure has stopped. The software will display interruption errors, which is expected. The errors can be cleared which will enable x-rays to be taken.
10. Press the green button again and let the exposure start. This time, open the specimen door, which should disengage the safety switches and force the exposure to stop. The software may display errors, clear them.

ACR Phantom (Wax Insert Only) – To be performed annually

Print this page to use as reference if needed.

Record results under “ACR Phantom Test” on the Periodic Maintenance Record – Faxitron Path, located at the end of the Section.

The user should be familiar with using the Faxitron Path and should know the procedures of taking X-Rays. Complete the setup procedures and make sure that the camera is calibrated, (Note the calibration kV and time), enter the patient data, and take a picture of the wax Insert portion of mini ACR Phantom shown in Figure 8.1. NOTE: The image will be taken with the wax insert removed from its acrylic holder.

The Mini ACR Phantom contains 12 objects: 4 masses, 4 fibers, and 4 groups of calcifications (specks). Each calcification group contains 6 individual calcifications or specks. All masses, fibers, and calcifications must be visible.

Note: The last group of calcifications may not be visible in this picture.

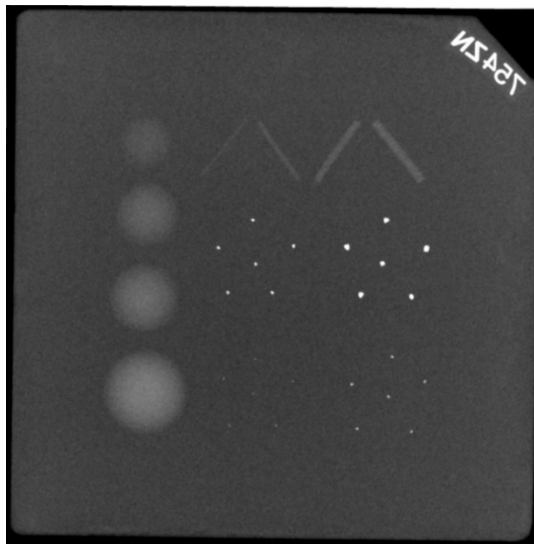

8.8.1 ACR Phantom Test

Figure 8.1
Typical X-ray image of wax insert of the Mini ACR Phantom (Nuclear Associates P/N 18-250)

ACCEPTANCE REQUIREMENTS

1. Configure the system to take a manual image of the wax insert of the Mini ACR Phantom. Set the kV and time to those noted during the calibration.
2. Make sure that the Phantom is clean and free of debris.
3. Place the wax insert directly on the chamber floor in the middle of the image area. Do not use attenuator blocks.
4. Start X-Rays and wait for all processing to be completed and the image to be displayed.
5. All the phantoms' objects may not be visible when the image is first displayed. Adjust contrast and brightness levels as needed for best image.
6. Once the image is corrected, all groups of objects should be visible.
7. Record results on the Periodic Maintenance Record.

Radiographic Survey – to be performed at least annually or if device has been dropped or damaged.

The following pages can be printed and used as instructions for performing the Radiographic Survey.

Record results under “Radiographic Survey” on the Periodic Maintenance Record – Faxitron Path, located at the end of the Section.

The manufacturer recommends that a radiographic survey be performed at least annually* to ensure radiation emissions are within the required limits. If the machine is damaged in any way after installation, the radiographic survey should be conducted prior to putting the machine back into use at the facility.

8.8.2 Radiographic Survey

Required Tools

- Radiographic Survey Meter with Check Source (recommended ionization chamber type survey meter like Inovision 451B, check source comes with device)
- 1 gallon (4 liter) plastic jug of water.

Verify Survey Meter Operation

1. Calibration date: Verify that the survey meter calibration is current.
2. Battery Check: Check for proper battery condition. Replace batteries if required.
3. Check Operation: *(If check source if available). Note: The following steps apply to the Inovision 451B or similar Ion Chamber Survey Meters. Follow manufacturers' instructions for other meters.*
 - Open the sliding Beta Shield on the bottom of the Survey Meter.
 - Set the meter down on the Check Source and monitor for 30 seconds.
 - Survey Meter should read within tolerance listed on Calibration label.
 - Enter the reading on the Periodic Maintenance Record.
 - Close the meter's Beta Shield.

Important Notes

1. All radiation measurements are taken with the radiation Survey Meter no more than 2 inches (5cm) from the surface of the Faxitron Path unit.
2. When recording the radiation measurements, they may need to be multiplied by 0.1 to convert the reading from uSv/hr to mR/hr. For example, 12 uSv/hr is equal to 1.2 mR/hr.

Radiation Survey Procedure

8.8.2 Cont.

1. Take a background radiation reading (point meter toward the center of the room) and record the value.
2. Configure the system to take a manual image.
 - a. Click the Device Panel button and select Full Manual.
 - b. Drag the kV and Time sliders to the far right to maximize the selected kV and Time values.
 - c. Click on the “SET” button.
3. Verify that the “Ready” LED is on.
4. Open the chamber door. Place the 1 gallon (4 liter) plastic jug of water on the chamber floor imaging area and close the door.
5. Press the “START” button and survey radiation emissions at the top, front, back, and both sides of the cabinet. Slowly scan the entire surface with the meter. It should take 1-2 x-ray exposures to complete each scan. Note: You will have to start x-rays multiple times to complete the entire survey.
6. Record the readings for each test location.
7. If any readings are higher than the Faxitron radiation emission limit of 0.1 milli-Roentgen (mR) per hour (1.0 μ Sv/h) at any point 5 centimeters (cm) outside the external surface (*), contact a Faxitron representative to discuss repair options.

(*) 0.5 mR/h at 5 cm from external surfaces is the upper limit by US FDA CDRH for cabinet x-ray systems. If used in another country please check with the hosting country’s official limits for cabinet based in-vitro diagnostic radiography equipment)

For some countries, the test points should be at 10 cm from external surfaces and in this case Faxitron radiation emission should read less than 0.1 mR/h at 10 cm from external surfaces.
8. Remove the jug of water from the x-ray chamber.
9. The bottom of the x-ray cabinet should be surveyed if the system is on a table, or if there are personnel on the floor below where the system is used. Verify there is nothing in the x-ray chamber, start an x-ray and scan the bottom of the cabinet. Record reading.

Periodic Maintenance Record - Faxitron Path

System S/N: _____

Camera S/N: _____

Safety Interlocks and Indicators – per Section 8.8.0

Pass: _____ Fail: _____ Initials: _____ Date: _____

If failed, state the reason and the actions taken to correct the failure.

Initials: _____ Date: _____

ACR Phantom Test – per Section 8.8.1

Number of objects observed: _____ Masses: _____ Fibers: _____ Calcification Groups: _____

Pass: _____ Fail: _____ Initials: _____ Date: _____

If failed, state the reason and the actions taken to correct the failure.

Initials: _____ Date: _____

Radiographic Survey – per Section 8.8.2

Radiation Readings in: mR/hr μ Sv/hr Check Source: _____ Background: _____

Front: _____ Right Side: _____ Top: _____

Back: _____ Left Side: _____ Bottom: _____

Pass: _____ Fail: _____ Initials: _____ Date: _____

If failed, state the reason and the actions taken to correct the failure.

Initials: _____ Date: _____

The periodic maintenance identified above was completed by: _____

Date Completed: _____ Signature: _____

9

SECTION 9
Revision History

Revision	Date	Description of Change	Originator	Approved by
1.0	29-June-2012	Initial Release	Ciaran Purdy	Doug Wiegman
1.1	28-Jan-2016	Minor updates	Mikhail Viznyuk	Ciaran Purdy
2.0	24-Oct-2018	Updated software images for metro release. Add revision section. Re-numbered pages into sections. Index removed.	Cary McLaughlin	Ciaran Purdy
021	16-Jul-2019	<ul style="list-style-type: none"> • Minor Revisions to Section 0 • Authorized EU Rep updated in Section 1 • Changes to Section 2: <ul style="list-style-type: none"> - Added Warnings, Interoperable Connections, and Cybersecurity - Deleted "Start Up Sequence" - Deleted "Shut Down Procedure" - Added Radiation Safety information • Deleted un-necessary information from Section 3. • Re-organized Section 4 for better flow and deleted un-necessary information • Section 5 – Re-organized numerous sub-sections for more logical progressions, <ul style="list-style-type: none"> - Revised Start-up sequence - Revised Camera Calibration section - Changed flow of Patient Data - Revised various sub-sections for clarity • Added Cybersecurity information • Changes to Section 8: <ul style="list-style-type: none"> - Updated Cleaning information in 8.1.0 and 8.2.0, - Corrected references in 8.7.0, - Updated and revised maintenance sections, 8.8.0, 8.8.1, and 8.8.2 for clarity. - Deleted Maintenance Sign-Offs from Sections 8.8.0, 8.8.1 and 8.8.2 - Created a New single page Sign Off Sheet. 	Alan Mihalko	S. Howerton J. Mudd D. Canny D. Saraiya R. Nash T. Longo M. Fremont
022	12-3-2019	Updated branding	Dhaval Saraiya	C. Purdy D. Saraiya R. Nash M. Fremont S. Howerton T. Longo
023	July 2021	Updated Manufacturer and EU Rep Added AU Sponsor Updated Service Contact Information	Alan Mihalko	See CCB
024	August 2021	Added "Consult IFU" symbol and "package-inserts" web address/link Added Brazilian Contact information	Alan Mihalko	See CCB