

Faxitron[®] Path+

Specimen Radiography System

User's Manual

from Hologic[®]

Document #: 5081-9545

Revision: 003

Issued: August 2021

Faxitron Path+ was previously known as PathVisionXL

© 2019 - 2021 Hologic® Inc.

All rights reserved. No parts of this work may be reproduced in any form or by any means - graphic, electronic, or mechanical, including photocopying, recording, taping, or information storage and retrieval systems - without the written permission of the publisher.

Products that are referred to in this document may be either trademarks and/or registered trademarks of the respective owners. The publisher and the author make no claim to these trademarks.

Read all this information carefully before operating the system. Follow all warnings and precautions as stated in this manual. Keep this manual available during procedures. Always follow all the instructions in this manual. Hologic® does not accept responsibility for injury or damage from incorrect system operation. Hologic can arrange for training at your site.

Foreword

This manual was created by Hologic® Inc. It is intended to guide the user on how to setup, install and use the Faxitron Path+ hardware and the Vision Software System, both developed by Hologic® Inc.

Faxitron Path+ was previously known as PathVisionXL

The user must first setup the hardware, then initiate the Vision Software. Please review the required setup procedures in Part 2 of this manual before continuing.

Intended Use

The **Faxitron Path+** is a Cabinet x-ray system that is used to provide film and/or digital x-ray images of harvested specimens from various anatomical regions in order to provide rapid verification that the correct tissue has been excised during the biopsy procedure. Doing the verification directly in the same room or nearby enables cases to be completed faster, thus limiting the time the patient needs to be under examination. Specimen radiography can potentially limit the number of patient recalls.

✓Prescription use (Part 21 CFR 801 Subpart D)

Caution: Federal law restricts this device to sale by or on the order of a physician.

The system can operate as a stand alone device. If connected to a network it is critical that measures are implemented to reduce the risk to patients by decreasing the likelihood that device functionality is intentionally or unintentionally compromised by inadequate cybersecurity.



www.hologic.com/package-inserts

SECTION 1:	User's Manual for the Faxitron Path+	1-1
1.0.0	Introduction	1-2
1.1.0	Warning and Caution Symbols in this Manual	1-2
1.1.1	Warning and Caution Symbols On Labels	1-3
1.2.0	Product Labels	1-4
SECTION 2:	Faxitron Path+ Installation and Set-up	2-1
2.1.0	System Warnings and Precautions	2-2
2.2.0	Faxitron Path+ System Setup	2-4
2.3.0	Specifications	2-5
SECTION 3:	Camera Calibration	3-1
3.1.0	Calibration	3-2
SECTION 4:	Quick Start - Basic Operation of the Faxitron Path+	4-1
4.1.0	Quick Start	4-2
4.2.0	Manual Mode	4-6
4.3.0	Shutdown	4-6
SECTION 5:	Vision Software Operation	5-1
5.0.0	Overview of Vision Software	5-2
5.1.0	Software Start-up	5-3
5.2.0	Advanced Calibration	5-3
5.2.1	Camera Calibration Overview	5-4
5.3.0	Patient Data	5-7
5.3.1	Inverting, Window Level and Contrast Adjustment	5-11
5.3.2	Dynamic Zoom Adjust	5-12
5.3.3	Enhance Image	5-13
5.3.4	Annotations	5-13
5.3.5	PACS Store	5-13
5.3.6	PACS Print	5-13
5.3.7	Back to Procedure	5-13
5.3.8	Device Control Panel	5-14
5.3.9	Shutdown	5-14
5.3.10	View Display	5-15
5.3.11	Tools	5-17
5.4.0	Image Tools	5-21
5.4.1	Original Contrast	5-21
5.4.2	Invert	5-21
5.4.3	Magnify	5-21
5.4.4	Edge Enhance	5-22

5.4.5	ROI Contrast	5-22
5.4.6	ROI Window/L	5-22
5.4.7	Ruler	5-23
5.4.8	ROI Statistics	5-24
5.4.9	ROI Histogram	5-25
5.4.10	ROI Profile	5-25
5.4.11	Line Profile	5-26
5.4.12	Built-In Window Level	5-26
5.5.0	Current Patient Images Browser	5-27
5.5.1	Database	5-27
5.5.2	Database Additional Options	5-29
5.6.0	DICOM Functionality	5-33
5.7.0	User Annotations	5-41
5.8.0	About Help	5-44
5.9.0	About Vision Software	5-44
SECTION 6: Compliance Requirements and Safety Measure		6-1
6.1.0	Compliance Requirements and Safety Measure	6-2
6.2.0	DICOM Standard	6-3
SECTION 7: Service & Troubleshooting		7-1
7.1.0	Service & Troubleshooting	7-2
SECTION 8: Schedule of Maintenance		8-1
8.0.0	Maintenance	8-2
8.1.0	Internal	8-2
8.2.0	External	8-2
8.3.0	Replaceable Parts	8-2
8.4.0	Equipment Needed	8-2
8.5.0	Reference Information	8-3
8.6.0	Definitions	8-3
8.7.0	Periodic Maintenance	8-3
8.8.0	Safety Interlocks and Indicators	8-4
8.8.1	ACR Phantom Test	8-5
8.8.2	Radiation Survey	8-6
SECTION 9: Revision History		9-1
	Revision Table	9-2

1

SECTION 1 Introduction

This manual was created by Hologic. It is intended to guide the user on how to setup, install and use the Faxitron Path+ hardware and Vision Software, both developed by Hologic.

1.0.0 Introduction

The user must first setup the hardware, then initiate the Vision Software. At a minimum, please review the required setup and safety procedures in this manual before attempting to operate the system.

Thank you from all of us at Hologic.

Manufacturer and Contact Information



Hologic, Inc.
36 Apple Ridge Road
Danbury, CT 06810 USA
1.800.447.1856
www.hologic.com

AU SPONSOR

Hologic (Australia and New Zealand) Pty Ltd
Suite 302, Level 3
2 Lyon Park Road
Macquarie Park NSW 2113
Tel: 02 9888 8000



Hologic, BV
Da Vincilaan 5
1930 Zaventem
Belgium
Tel: +32 2 711 46 80
Fax: +32 2 725 20 87



The following symbols are used in this manual and online help system:

Warns the reader of potential electrocution should the reader ignore the warning and deliberately use specialized tools to open a sealed electrical cabinet and handle its contents. Note: No tools are provided.



Warns the reader of a hazardous condition. This symbol is generally accompanied by a more specific symbol and appropriate instructions as to the nature of the hazard, the expected outcome of the hazard, and information on avoiding the hazard.



Cautions the reader to use care in lifting heavy equipment in order to avoid personal injury and damage to the equipment.



Warns the reader that ionized radiation is emitted into the labelled area when the x-ray beam is energized. The Faxitron Path+ has safety interlocks to prevent the labelled area from being accessed while the x-ray beam is energized.

















Warns the reader to use appropriate protection (such as surgical gloves or an approved specimen container) to avoid exposure to potentially infectious materials such as patient tissue samples.



1.1.0 Warning and Caution Symbols in this Manual

1.1.1 Warning and Caution Symbols On Labels

Symbol	Description
	Discard electrical and electronic equipment separately from standard waste. Send decommissioned material to Hologic or contact your service representative.
	Manufacturer
	Date of Manufacture
 or 	Caution—Radiation (X-Rays Produced)
	Caution - Potentially infectious materials
	Warning Electricity
	Caution
 or 	Follow or consult instructions for use
	This system transmits radio frequency (RF) energy (non-ionizing radiation)
	European Authorized Representative
	Medical Device
	Catalog number
	Serial number

Label Locations

1.2.0 Product Labels

Figure 1.2.1 - Warning and Safety Labels

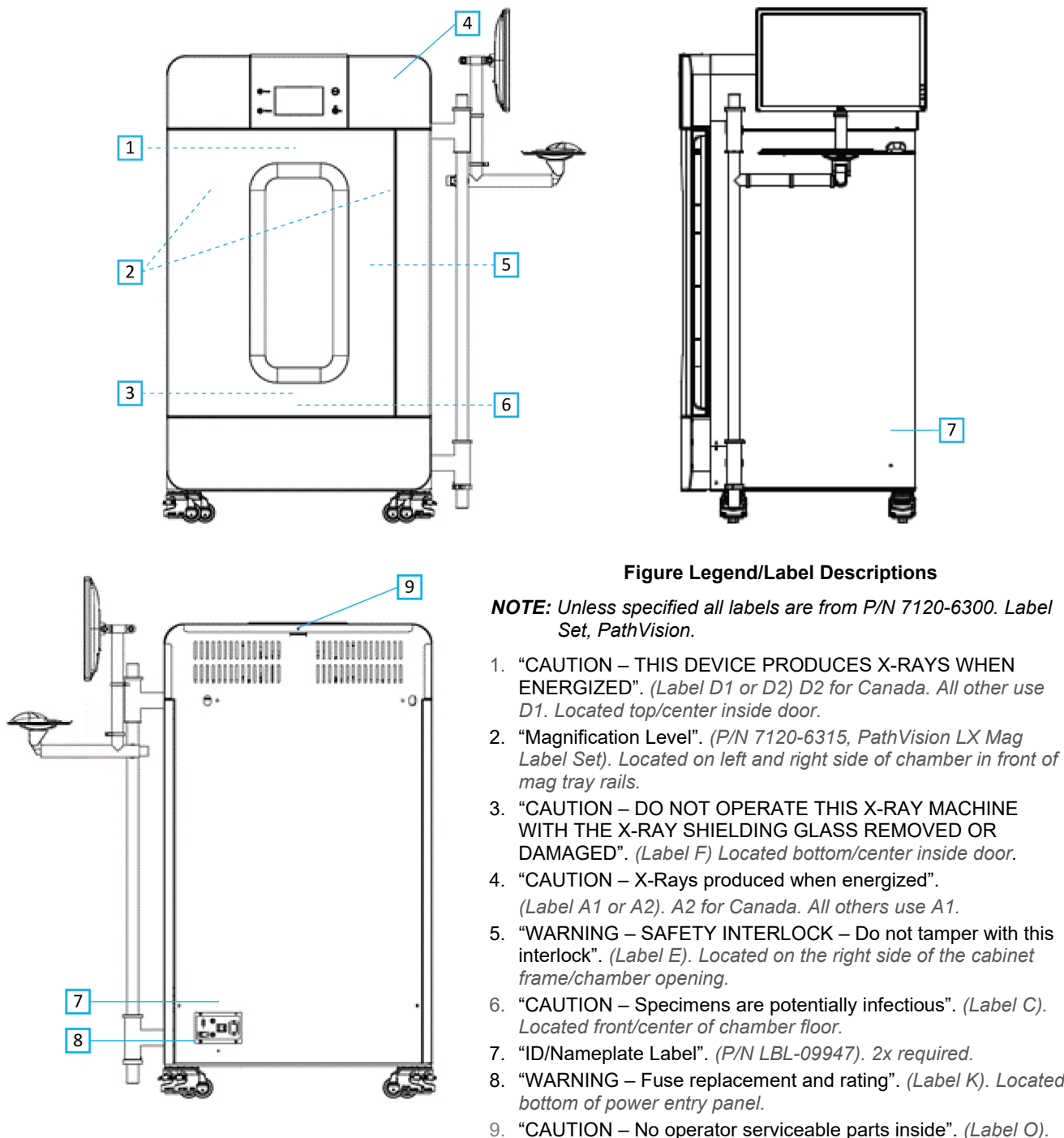

Figure Legend/Label Descriptions

NOTE: Unless specified all labels are from P/N 7120-6300. Label Set, PathVision.

1. "CAUTION – THIS DEVICE PRODUCES X-RAYS WHEN ENERGIZED". (Label D1 or D2) D2 for Canada. All other use D1. Located top/center inside door.
2. "Magnification Level". (P/N 7120-6315, PathVision LX Mag Label Set). Located on left and right side of chamber in front of mag tray rails.
3. "CAUTION – DO NOT OPERATE THIS X-RAY MACHINE WITH THE X-RAY SHIELDING GLASS REMOVED OR DAMAGED". (Label F) Located bottom/center inside door.
4. "CAUTION – X-Rays produced when energized". (Label A1 or A2). A2 for Canada. All others use A1.
5. "WARNING – SAFETY INTERLOCK – Do not tamper with this interlock". (Label E). Located on the right side of the cabinet frame/chamber opening.
6. "CAUTION – Specimens are potentially infectious". (Label C). Located front/center of chamber floor.
7. "ID/Nameplate Label". (P/N LBL-09947). 2x required.
8. "WARNING – Fuse replacement and rating". (Label K). Located bottom of power entry panel.
9. "CAUTION – No operator serviceable parts inside". (Label O).

2

SECTION 2
Faxitron Path+
Installation and Set-up

Warnings

- Please read the instructions carefully before using the system.
- Do not use the system in any other way than its intended use as described in this manual. If in doubt contact Hologic or your authorized distributor.
- Not all power cords have the same rating. Do not use any other power cord with this system other than the one provided. Do not use the power cord from this system on any other equipment.
- This system is tested to the highest international standards; however, it is recommended that you contact your national authorities recording any local operational requirements.
- This system is not intended for public use. It must be located in an area where the general public cannot access the system without an operator being present.

General Precautions

The following precautions must be taken to prevent damage to your Faxitron Path+ System:

- Never connect or disconnect communication and/or power cables, while the detector system power is on. Damage to the CMOS detector or the electronics may occur if the cables are connected / disconnected while the power is on.
- The detector system is fragile and care should be taken to prevent detector damage. The detector system must never be mishandled, hit, knocked or dropped.
- The Faxitron Path+ System has a calibration mode. Calibration must be completed daily to ensure proper system function. Please refer to the Calibration Procedure.
- Caution – Use of controls or adjustments to performance of procedures other than those specified herein may result in hazardous radiation exposure

Interoperable Connections

The Faxitron Path+ is capable of operating as a standalone device without any input or output to other devices. Images can be captured, stored and reviewed directly on the system.

However, the system does come with several interfaces. The primary one is the network connection which allows the system to be connected to a Picture Archiving and Communication System (PACS). Images can then be transmitted from the device directly to the facilities network via our software in a DICOM format. See Section 6 for details on DICOM version. Only Hologic employees or trained IT personnel at the user facility should set up this communication.

The system's connections and their intended use are listed below. No other type of devices should be connected to the Faxitron Path+ without approval from Hologic.

Connection	Purpose	Device Type	Intended User
Ethernet port at rear	To store radiographic images to networked data storage	PACS or Network storage	Set up by Hologic or facility IT personnel. Used by clinicians.
Ethernet port at rear	To allow remote connection by the Hologic service team, so Hologic can diagnose and repair the system.	Network internet connection	Hologic or facility IT personnel at the direction of Hologic only.
USB port on the monitor	To transfer images from device. This should only be used if PACS or network is not available.	USB storage device (Flash Drive)	Clinicians or IT personnel with approved access to the system.
USB port on the monitor	To service and maintain the system. For example, files copied to and from the computer for software updates or to export log files.	USB storage device (Flash Drive)	Hologic or facility IT personnel
USB port at the rear	To allow connection of a printer. Vision software allows for connection of a DICOM printer or a standard windows compatible printer.	DICOM or windows printer	Clinicians or facility IT personnel

2.1.0 System Warnings & Precautions



Cybersecurity

Device security is a shared responsibility between Hologic and the health care facilities. Failure to maintain cybersecurity can result in compromised device functionality, loss of data (medical or personal) availability or integrity, or exposure of other connected devices or networks to security threats. Hologic maintains a set of cybersecurity controls to assure the cybersecurity of its units and to maintain their functionality and safety.

All our units use standard Windows operating system. At installation, we recommend the facility install all the necessary security measures as defined by their own internal requirements, as they would with any other PC connected to the network.

The facility can set up the Windows operating system with all the network protocols and permissions necessary. For example, they can add

- User ID and passwords,
- Layered authorization with appropriate authentication,
- Restrictions on software installations,
- Trusted content requirements, including code signature verification,
- Set up windows updates including security releases.

In addition, our imaging software (Vision) can be password protected so certain users can get on to the operating system without being able to open the Vision software.

The unit comes with a physical key that powers on the X-Ray system. This allows the system to be locked out so even if the software is accessed no x-rays can be initiated.

This unit is designed to be used either as a standalone unit or connected to the Facility's internal PACS or other closed-loop network. It is not intended to be connected to the Internet, unless (a) the Facility is specifically instructed to do so by Hologic, and (b) the Facility takes adequate precautions to ensure the cybersecurity of the unit from threats related to its Internet connection.

Hologic will develop updates or patches for the software to continue to assure the product's safety, as needed throughout the lifecycle of the unit.

Additional security measures, including encryption, can be implemented and Hologic can work with the facilities IT department to reduce the risk to patients as a result of a cybersecurity breach.

Network / User Settings

The detector on the Faxitron Path+ uses an ethernet (network) connection to communicate. Adding users or setting additional network security can prevent the detector from communicating to the software. Set up additional users with local administration rights to ensure the software runs correctly. Work with the Hologic team during installation to make sure the system is configured properly.

Cleaning

Internal Chamber

Samples containing biological specimens can harbour infectious agents that are hazardous to your health. Follow appropriate biosafety procedures: wear gloves when handling tissue specimens or any material which they come in contact with.

Periodically wipe down the interior of the cabinet with 70-90% isopropyl alcohol or diluted sodium hypochlorite (5.25%-6.15% household bleach diluted 1:500 provides the proper concentration). Ensure the specimen area, marked on the chamber floor, is thoroughly cleaned.

External Chamber

Periodically wipe down the exterior surfaces with mild soap and water.

Do not drench or flood surfaces and do not use abrasives which may scratch surfaces. Do not allow any moisture to contact any of the systems electrical components.

Test cleaning agents on a small inconspicuous area of the plastic and metal covers to verify they will not damage the finish.

2.1.0 System Warnings & Precautions



The Faxitron Path+ should only be set up by a Hologic authorized representative.

2.2.0 Faxitron Path+ System Setup

Inspecting the Crate

The Faxitron Path+ System arrives in one large wooden crate. Have the shipping agent transport the crates to an area where they can be kept safe from theft, damage, and environmental extremes until the authorized representative can install the system.

Check crate for any damage. If it appears to be damaged, contact Hologic at +1 520-399-8180 or the local representative.

The crate is about 6 feet tall. It contains the specimen unit, the display monitor, the computer, and the system manuals.

Lifting and Transporting the Crate

Caution: The crate weighs approximately 1600 pounds (725 kg). The packaged system should be kept upright as indicated on the shipping crates.



Unpacking and Assembling the System

The Faxitron Path+ system will be unpacked and assembled on site by a Hologic authorized representative.

A forklift suitable to lift the load will be required to remove the system from the crate.

Safety Checks and Radiation Survey

During installation safety checks and radiation survey must be performed in accordance with the procedure described in Section 8 Schedule of Maintenance.



Location & Building Requirements

The Faxitron Path+ system has ventilation and the power entry connector is at the rear of the cabinet. Leave at least 6" (15cm) of clear space behind the unit when installed to allow the air to flow and give the user access to disconnect the power cord.



Ensure that the floor is designed to sustain that load over the life of the product. Check with local building regulations. Also ensure that the route to the room where the system will be located can withstand the temporary load of the cabinet during its transportation and installation.

When in position ensure the 4 pads on the casters are lowered to hold the weight of the system. The Faxitron Path+ is a lead shielded large X-Ray cabinet that weighs 635kg or 1400lbs. The four pads on the casters will exert a force of 160kg (350lbs) per caster, equivalent to 900 kPa or 130 lbs/in².

Environmental Conditions

2.3.0 Specifications

Operational:

Temperature: 15.5 to 30 degrees C or 60 to 86 degrees F.
Relative humidity: < 75 percent.

Storage and transport:

Temperature: 0 to 45 degrees C or 32 to 113 degrees F.
Relative humidity: < 75 percent.

This equipment is designed for the following conditions:

- Indoor use
- Altitude up to 2000 meters
- Pollution Degree 2
- Over-voltage Category II

RADIATION SAFETY

- Radiation shielded cabinet.
- Compartment door equipped with dual safety interlocks.
- Radiation: Less than 0.1 mR/hr at 5 cm (2 in.) from exterior surface at maximum kV.
- Certified to comply with standards set by the US Food and Drug Administration, Center for Devices and Radiological Health, (21 CFR-1020.40).
- Designed to comply with standards set forth by IEC 61010.

X-RAY TUBE

Focal spot size	< 15 um
kV	20-100kV
mA	1.0mA max
Power	Isowatt limited to 11.5W max
Beryllium window thickness	0.010" (254um)
X-ray beam divergence	40 deg. min.
Target Material	Tungsten (W)

BEAM COVERAGE (BC) AND SOURCE TO OBJECT DISTANCE (SOD) AT DIFFERENT SHELF POSITIONS/MAGNIFICATIONS FACTORS

Shelf Position/ MAG Factor	BC Nominal diameter cm (Inches)	SOD cm (Inches)
10	6.1 (2.4")	9.2 (3.6")
8	76.2 (3.0")	11.5 (4.5")
6	10.2 (4.0")	15.3 (6.0")
5	12.2 (4.8")	18.3 (7.3")
4	15.3 (6.0")	22.9 (9.0")
3	20.3 (8.0")	30.5 (12.0")
2	30.5 (12.0")	45.8 (18.0")
1.5	41.6 (16.0")	61.0 (24.0")
1 (Floor)	61.0 (24.0")	91.5 (36.0")

RADIOGRAPHIC MAGNIFICATION: Up to 10 times

EXPOSURE CONTROL: Automatic or Manual.

X-RAY DUTY CYCLE: 50%

LASER INFORMATION: Class 1 Laser Product
IEC 60825-1 Ed. 2
Complies with 21 CFR 1040.10 and 1040.11 except for deviations pursuant to Laser Notice No. 50, dated June 24, 2007.

POWER REQUIREMENTS: 100 - 240 VAC, 50/60 Hz, 300VA Max

MAX HEAT OUTPUT: 1000 BTU/hr

2.3.0 Specifications Cont.

X-RAY DETECTOR

Detector Size: 43cm x 43cm (17" x 17")

Detector Pixels: 4318 x 4320 @ 100um pitch

Panel: Single substrate amorphous silicon active TFT/diode array

Spatial Resolution: 100um at contact, (<20um with geometric magnification)

Limiting resolution: 5 lp/mm

ADC: 16bit

Typical DQE: 75% (0 lp/mm), 60% (1 lp/mm), 40% (3 lp/mm) for RQA5

Typical MTF: 70% (1 lp/mm), 40% (2 lp/mm), 15% (4 lp/mm) for RQA5

Scintillator: Direct Deposited CsI:TI

EXTERIOR DIMENSIONS (Approximate)

	cm	inches
Height	168	66
Width	137	54
Depth	81	32

COMPARTMENT INTERIOR DIMENSIONS (Approximate)

	cm	inches
Height	86	34
Width	63	25
Depth	63	25

WEIGHT (Approximate)

	With Computer, monitor, keyboard and accessories	
	kg	lbs
Net	635	1400
Shipping	725	1600

DIMENSIONS (Approximate)

2.3.0 Specifications Cont.

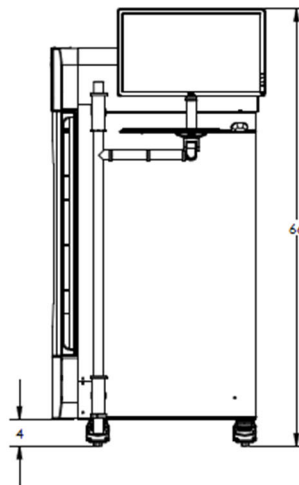
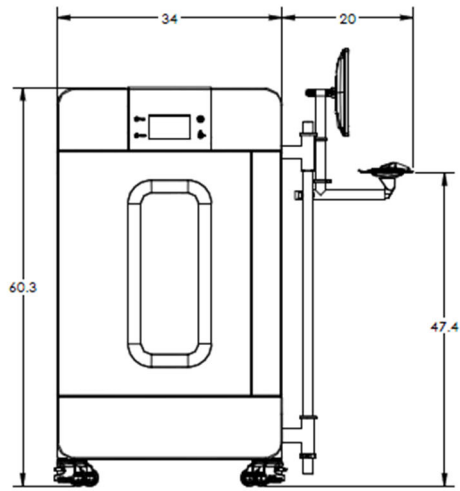
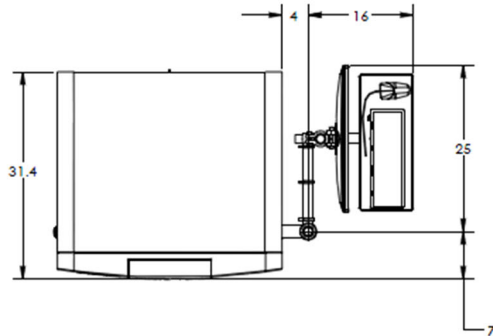

3

SECTION 3 **Camera Calibration**

Calibration

On first installation the system should be allowed to reach the ambient room temperature. Upon initial start-up of the system a system calibration should be performed and can be done at any time if there are any concerns with image quality.

To optimize image quality, Vision Software and the hardware requires periodic calibration. This calibration requires the acquisition of reference images. These images can be grouped into three (3) categories: Offset images, Dark images and Flat-field images.

Caution: Verify the chamber is empty prior to starting calibration.

To manually start Calibration click on the “Calibrate” button.

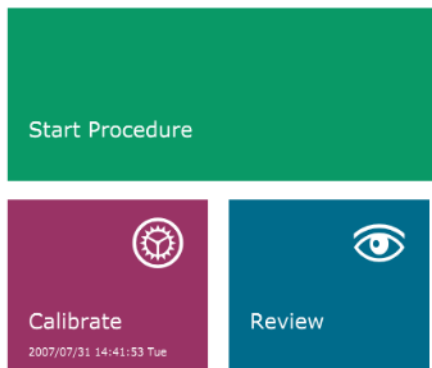

Figure 3.0.1
Calibrate System Button

The user will then be prompted to start calibration.

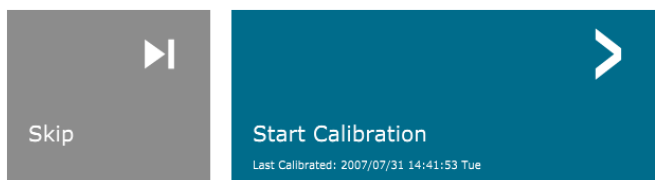

Figure 3.0.2
Start Calibration prompt

ENSURE THE CHAMBER IS EMPTY BEFORE CALIBRATION

Calibration before beginning any procedure is recommended

Once pressed, the calibration is performed.

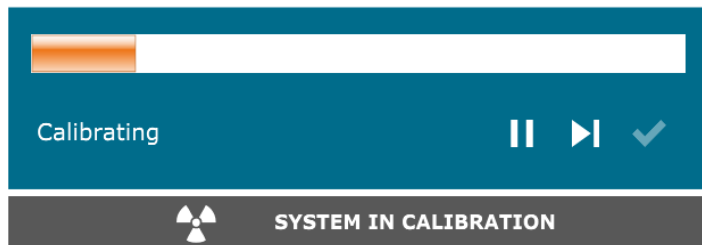

Figure 3.0.3
Calibration Progress

During the calibration, the “System in Calibration” button, shown above, will indicate an “Exposure Status”, with the message: “X-RAY IS ON, WAIT FOR COMPLETION”. The user may stop X-Ray exposure by pressing on this button at any time.

The Calibration will automatically go to the Home menu on completion.

Typically, the Faxitron Path+ will calibrate around 30kV for 15 seconds to get 8000ADU. This will vary system to system.

4

SECTION 4
Quick Start
Basic Operation of the
Faxitron Path+

Before powering up the system, please make sure that all cabling connections are secured.

4.1.0 Quick Start

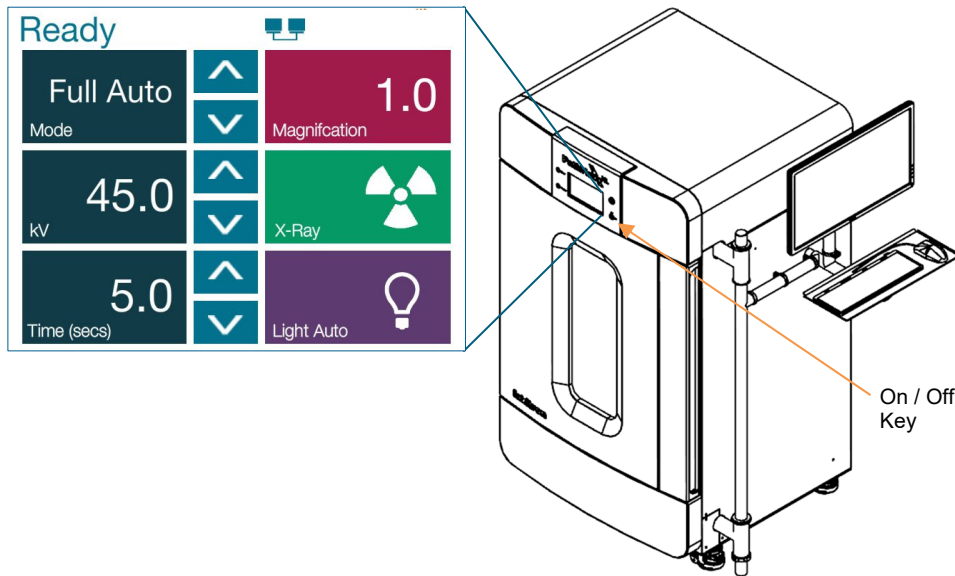

Figure 4.1.1
Faxitron Path+ front panel

System Start-up Sequence Protocol

This start-up sequence must be followed to ensure proper system function and image quality:

Power Up System

- Turn the power on to the Faxitron Path+ System by switching the power switch On, the power button is located on the back of the system next to the power cord outlet. Switch to "1" for "Power ON and "0" for "Power OFF".
- Turn the Faxitron Path+ System "ON" by inserting the Faxitron Path+ Key into the key lock switch, located on the front panel and turning it clockwise to the 3 o'clock position. Note: the key cannot be removed in this position.
- Turn on the monitor if it is not already on.



Start Software

- Verify there is nothing in the Faxitron Path+ x-ray chamber.
- The Vision software should automatically start when the Windows operating system has completed booting. If the software doesn't automatically start "Double Click" the Vision Icon on the Windows desktop.



Figure 4.1.2
VISION Desktop Icon

Calibrate

- Upon initial start-up of the day the software should open to the Calibration page.
- Press the "Calibrate" button and allow the system to complete the calibration.

Additional Recommendations for Consistent Image Quality

Allow the system to warm up for a minimum of a half hour before calibration and image acquisition. Perform a complete calibration daily prior to initial system use. The system is configured to perform this calibration when you start the Vision software.

Basic Imaging Procedures

4.1.0 Cont.

Warning: Use approved containers or gloves in order to avoid contact with any potentially hazardous samples.

Caution – Use of controls or adjustments or performance of procedures other than those specified herein may result in hazardous radiation exposure.

Note - During the setup of the detector and software the touch panel on the X-Ray cabinet will show the status at the top of the screen. For example – Calibrating, Stand-by and Ready



Start Procedure

- From the Home Menu page select the **Start Procedure** button.

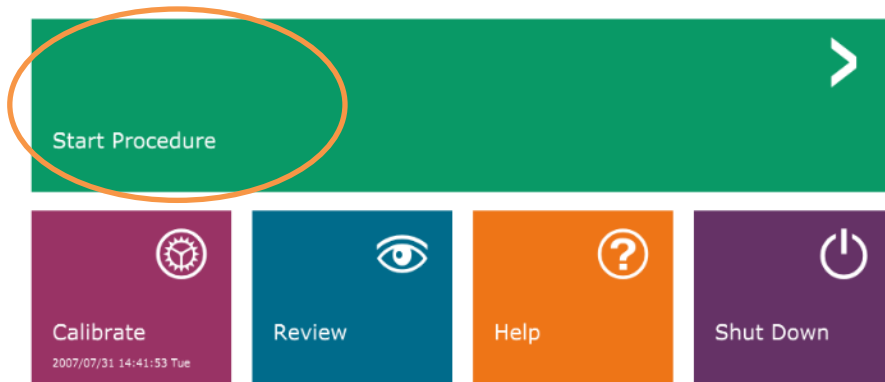

Figure 4.1.3
Vision Program Start-up (Home) Screen

- The user will be given options to **Select form Work List**, **Manual Entry**, **Select from Database**, or **Continue with current patient**.
- To manually enter a new Procedure, select the **Manual Entry** button.

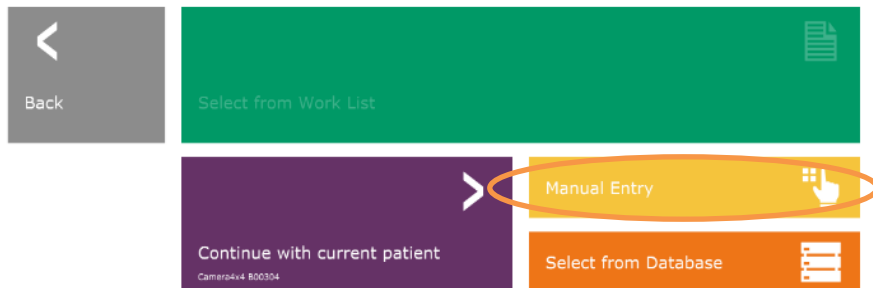

Figure 4.1.4
Start Procedure Options

- The **Patient Information Editor** dialog box will open

4.1.0 Cont.

Figure 4.1.5
Sample / Patient Data Screen

HOLOGIC®

Patient Information

Patient Name: * Camera4x4 M B00304

Patient ID: * B00304

Accession #: * B00304

Date of Birth: 2007/07/27

Gender: Female

Procedure Information

Procedure Name:

Laterality: * L

Position View:

Body Part:

Refer. Physician:

Technician:

Technician ID:

Study Information

Study Name:

Study ID:

Accept >

< Start a New Patient or Procedure

Note: Required Fields are indicated by a white asterisk (*).
Default required fields are: Patient Name, Patient ID, Accession Number, and Laterality.

- Enter all required fields. The **Accept** button will not be active if any required field is missing. The user may complete other fields as desired.

Note: The Date must be entered as year, month, day (e.g. 1962/08/13). If entered incorrectly, an error message will appear.

- Select **Accept** to enable image acquisition

X-Ray Imaging

4.1.0 Cont.

- Place specimen(s) in a specimen container provided by Hologic, Inc. or your institution, and lay it inside the PathVision x-ray chamber. The imaging area is designated by an outline decal. (The user may also place the specimen and container on the magnification tray provided with the PathVision system.)
- Press the green **Start X-ray** button (either in the software or on the front of the x-ray cabinet) to initiate image acquisition/x-rays.
- Wait until image is displayed.

Note: With the Full Auto mode selected, two X-Rays will be taken, the first to work out the best settings and the second to take the image. The settings used during exposure (kV and time) will be displayed in the cabinets' LCD screen.

Note: After the exposure is complete the system may collect a "dark" image to remove noise from the image. The dark image takes the same time as the x-ray exposure.
- The final image can then be saved to PACS by clicking the Store icon below.

Note: The Vision software is configured to automatically save the image to the Faxitron database on the system computers' local drive.

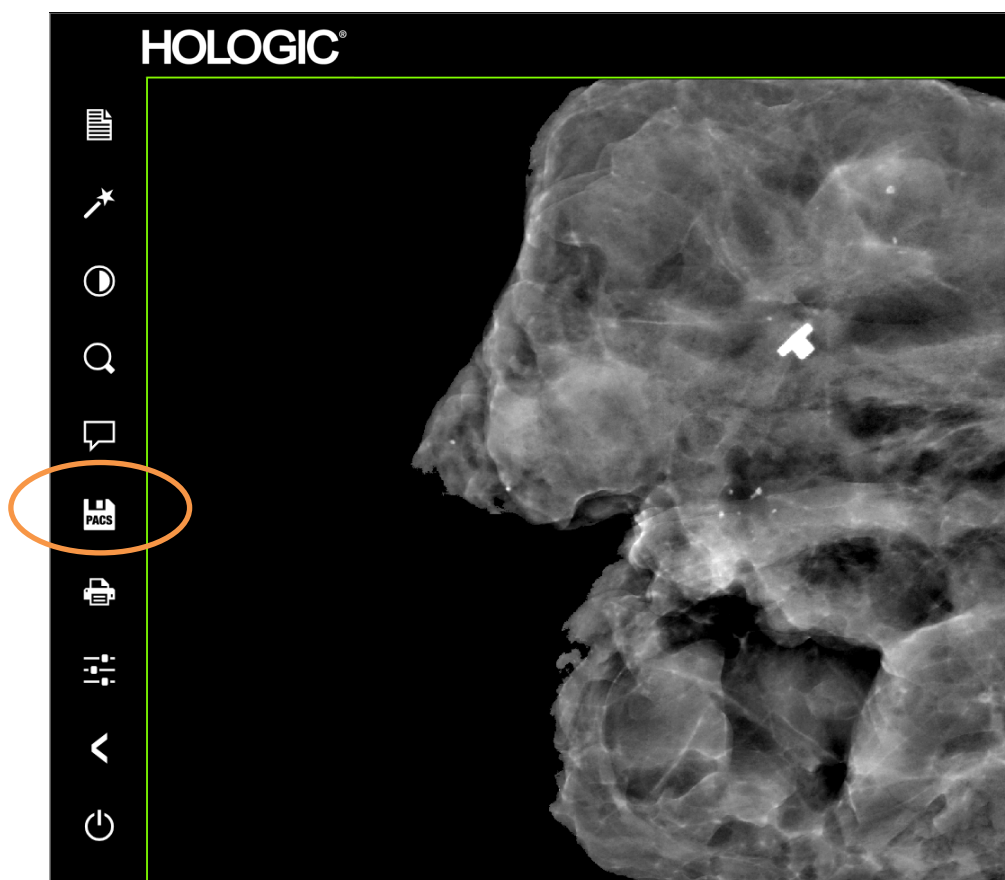

Figure 4.1.6
Image Screen

For more information on adjusting the image settings, X-ray controls, and reviewing and save options, see Section 5.

The Faxitron Path+ can operate without a computer / internal digital camera attached. In this mode the system can make X-rays and captured images via film or third-party imaging system.

When the system is not fitted with an internal digital detector and PC, the front panel will display an X through the Icon at the top of the screen and only manual mode will be selectable.

4.2.0 Manual Mode



Figure 4.2.1
Touch Panel

In this mode

- Place a sample in the chamber, on the bottom or on a magnification shelf.
- Set the desired kV (20-100kV) and Time (1-60 secs)
- Press "X-Ray"

Turn the key-switch on the front panel counter-clockwise until it stops and, if required, you can remove the key. Wait 30 seconds to ensure the computer powers down completely.

Note: Do not try to turn the system back on until the computer has powered down completely.

Note: There is no need to turn off the monitor as It will go into power saving mode automatically.

4.3.0 Shutdown

Figure 4.3.1
Shutdown System Icon

5

SECTION 5
**VISION Software
Operation**

Vision Software is a complete image acquisition and processing package, designed exclusively to work with Faxitron X-Ray Generators (such as VersaVision, PathVision, CoreVision and BioVision Systems.) In addition to the acquisition and processing functions, the software offers an extensive database module that allows user control and maintenance of image archiving, storage, filing and retrieval. The software is also Digital Imaging and Communications in Medicine (DICOM) compliant, allowing saving and printing of Patient images in DICOM format 3.0.

When started, the software will report that a calibration is needed and will offer the option to either start calibration or skip it. System calibration is required at the beginning of every new day of system use for best image quality.

Calibration may also be performed at any time by the user. After calibration, the Main Start-Up Menu will be displayed. It is from this screen that navigation to all other areas of the software is carried out. For ease of use, application buttons are provided, see *Figure 5.0.1*. These buttons are in the center of the screen. Button descriptions and definitions are outlined in the following sections of this manual.

5.0.0

Overview of Vision Software

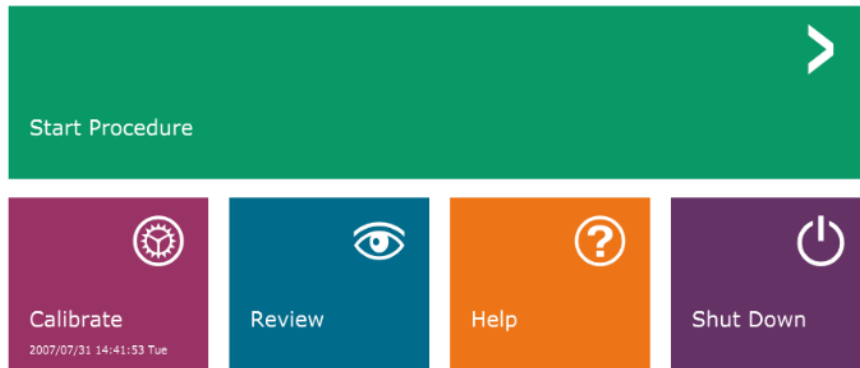

Figure 5.0.1
Vision Software
Start-up Screen

Sequence Protocol

This start-up sequence must be followed to ensure proper system functionality and image quality:

- Turn the power on to the Faxitron Path+ System by turning the key on the front of the unit to the "ON" position.
- Turn on the monitor if not done already.
- Allow the system to warm up for a minimum of a half hour before calibration and image acquisition.
- From the WINDOWS desktop, double click on the Vision Software icon, if Vision has not started already.
- Refer to the "Calibration Overview" section for calibration protocols.

Vision Software has been pre-installed on the computer packaged with your particular X-Ray system. In the event that Vision software is not set to automatically start, the user may need to activate the Vision Software by "double clicking" the left mouse button on the Vision Software icon located on the WINDOWS desktop. See *Figure 5.1.1*.



5.1.0 Software Start-up

Figure 5.1.1
Vision Software Desktop Icon

While the Vision software is loading, a Dialog box will appear to indicate software initialization.

Occasionally it may be desirable to incorporate the X-Ray attenuation characteristics of a uniform attenuator in the flat-field reference calibration images. For example, if all objects to be imaged are placed on a thin plastic plate, X-Ray attenuation characteristics of the plate will be observed in every image acquired. In this case, placing the plate in the X-Ray beam during flat-field reference calibration image acquisition could improve image quality.

Note: Different X-Ray generators have slightly different settings.

5.2.0 Advanced Calibration

Calibration Introduction

To optimize image quality, Vision Software and the hardware requires periodic calibration. This calibration requires the acquisition of reference images.

Upon initial startup of the system or at any time desired by the user, a system calibration may be requested and performed. It is recommended that after an elapsed time of twelve (12) hours, the following calibrations be performed.

These reference calibration images are used to calibrate a "raw" X-Ray image on a pixel-by-pixel basis to generate a "corrected" image for display. Image corrections performed include gain, offset and linearity corrections.

Calibration Sequence

For convenience, Vision software combines the numerous steps of calibration into a single unified step.

When a Faxitron X-Ray System has been turned off for longer than six (6) hours, the system will automatically request to re-calibrate. It is highly recommended that the system be re-calibrated after extended periods of inactivity or after the system is moved from one room to another room with potentially different ambient temperature/humidity settings.

To calibrate the system at any time, click the Calibrate button on the Vision Startup Screen (main screen) and then proceed to press "Start Calibration." The "Skip" feature may be used to skip the calibrations if desired before starting calibration and during calibration. However, this could result in sub-standard image quality. See Figure 5.2.1. The Dialog will display a status message during calibration.

During calibration, X-Rays may be generated. During X-Ray generation, a "Stop X-Ray" button will be made visible to allow a user the option to stop X-Ray through software.

5.2.1 Camera Calibration Overview

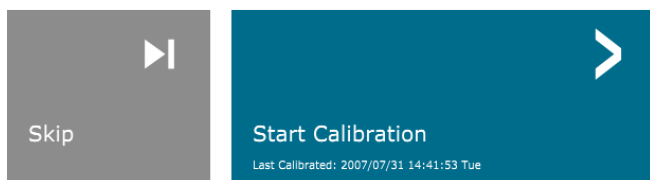
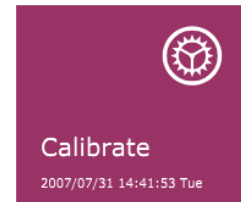

ENSURE THE CHAMBER IS EMPTY BEFORE CALIBRATION

Calibration before beginning any procedure is recommended



Figure 5.2.1
Detector Offset and Dark Field
Calibration Dialog Box

The following is a summary of the advanced calibration protocol for "Both" (Flat Field and Image):

Place the uniform attenuator on the detector. The entire detector surface should be covered by the attenuator. For ideal results, the attenuator should be larger than the detector's imaging area.

From the startup screen of the imaging software, press the top-right "^" icon to bring the menu into focus. Select the drop down menu item "Tools" in the horizontal menu located at the top of the screen and then proceed to "Advanced Tools" to "X-Ray Calibration/Exposure Setup".

5.2.1 Cont.

Figure 5.2.2
X-Ray Generator and Exposure
Dialog Box

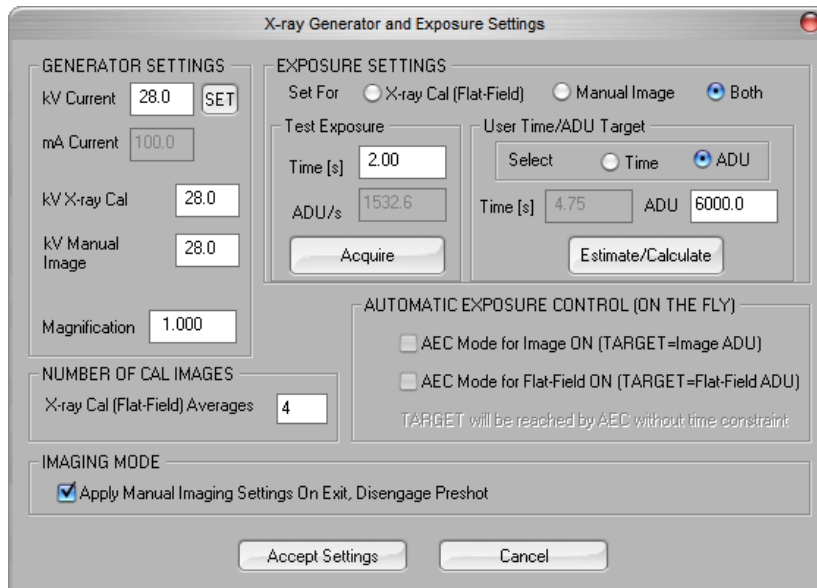

NOTICE: The values displayed in the example screen above are NOT necessarily correct for your type of X-Ray generator.

- Under "X-Ray Generator and Exposure Settings", enter the generator kV setting in the appropriate field.
- Set a "Magnification" or leave as the default setting of one (1.0).
- Select the "Set for" "Both" button in the dialog box.
- Leave the default "user ADU target" setting. X-Ray exposure will be terminated when the detector has accumulated a mean signal level of ADUs that are acceptable for the X-Ray generator you have.
- Leave the default test exposure time and click on the "Acquire" button. The system will automatically begin X-Rays and obtain an image.
- When the X-Ray exposure is complete, click on the "Estimate/Calculate" button.
- Record the calculated exposure time "Time [s]" reading. The system calculates this time and the number is greyed out.

- Enter the calculated exposure time reading "Time [s]" in the "Test Exposure" time box. Press the "Acquire" button to automatically begin X-Rays and obtain an image.
- When X-Ray exposure is complete, click on the "Estimate/Calculate" button.
- Record the calculated exposure time "Time [s]" reading.
- Enter the calculated exposure time reading in the "Test Exposure" time box once again.
- Click on the "Accept Settings" button.
- Perform a standard calibration procedure, as described in the "Camera Calibration Overview" section.

5.2.1 Cont.

Experienced users may wish to set the "X-Ray Cal (Flat-Field)" and "Manual Image" "Exposure Settings" independently or "Both" (Flat-Field and Manual Image) as previously described. By selecting the "Flat Field" radio button, the system will determine the optimum exposure time for acquiring Flat Field images at the desired ADU level. Accordingly, the selection of "Manual Image" will determine the optimum exposure time for the system with an object which will attenuate the X-Ray signal. For best results, the entire imaging area of the detector must be covered by the object.

After the selection of either "X-Ray Cal (Flat-Field)" and "Manual Image" and the ADU level has been set, select the "Acquire" button. For the "Manual Image" selection, it is desired to have the object or X-Ray attenuator in the X-Ray beam. Press the "Acquire" button to generate X-Rays and obtain an image. When X-Ray exposure is complete, click on the "Estimate/Calculate" button. The system calculates optimum time and the number is greyed out. When the "Accept Setting" is selected, the "Exposure Settings" are saved to the system's configuration file. **Note: Only the settings for the selected radio button are saved.** Next perform a standard calibration procedure, as described in the "Camera Calibration Overview" section.

The *Start Procedure* button takes the user to the Patient Data Entry page which provides methods to enter patient data. If a Work List has not been configured, the option will be greyed out and only the Continue with current patient, Manual Entry, and Select from Database options will be accessible. The options are explained in the next sections.

5.3.0 Patient Data

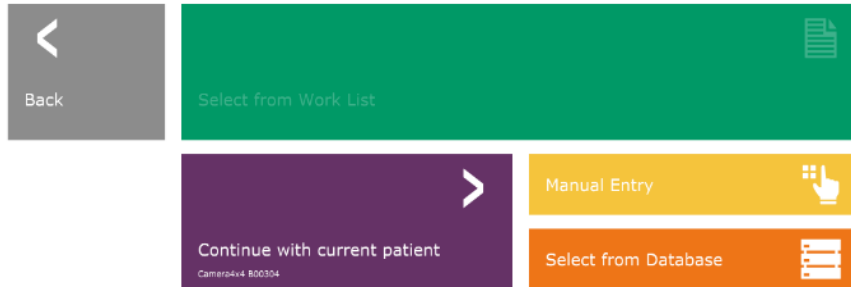

Figure 5.3.1
Patient Data Entry screen

ENTER MANUALLY

5.3.0 Cont.

To manually enter a new Procedure, select the "Manual Entry" button. The "Imaging Information Editor" window is displayed. See Figure 5.3.2.

The screenshot shows the 'Imaging Information Editor' interface. It features a dark background with a green sidebar on the left containing navigation icons. The main content area is a green form with the following sections:

- Patient Information:** Patient Name (required, *), Patient ID (required, *), Accession # (required, *), Date of Birth, Gender (dropdown).
- Procedure Information:** Procedure Name (dropdown), Laterality (required, *), Position View (dropdown), Body Part (dropdown), Refer. Physician, Technician, Technician ID (text inputs).
- Study Information:** Study Name, Study ID (text inputs).

At the bottom of the form, there is a blue 'Accept' button with a right-pointing arrow, and a grey button labeled 'Start a New Patient or Procedure' with a left-pointing arrow.

Figure 5.3.2
Imaging Information Editor

Note: Required Fields are indicated by a white asterisk (*). Default required fields are: Patient Name, Patient ID, Accession Number, and Laterality.

The user must enter all required fields prior to being able to select the "Accept" button. The user may also enter a Date, Referring Physician, Procedure Name, Accession Number, Sex, Technician, Position View, Body Part, and Study ID if so desired. The Procedure Name and Position View are chosen by a drop down menu.

Note: The Date must be entered as year, month, day (e.g. 1962/08/13). If entered incorrectly, an error message will appear.

Note: The "required fields" may be altered or deleted depending on the application. Contact Hologic support for further information.

Select Accept to accept or Start a New Patient or Procedure to return to the Patient Data Entry page.

Once an image is taken, the current image information (image properties) can be viewed by pressing the (i) icon in the top-right corner, shown in Figure 5.3.3.

5.3.0 Cont.



Figure 5.3.3
Image Properties Icon

The box is semi-transparent to allow one to see what's underneath the box.

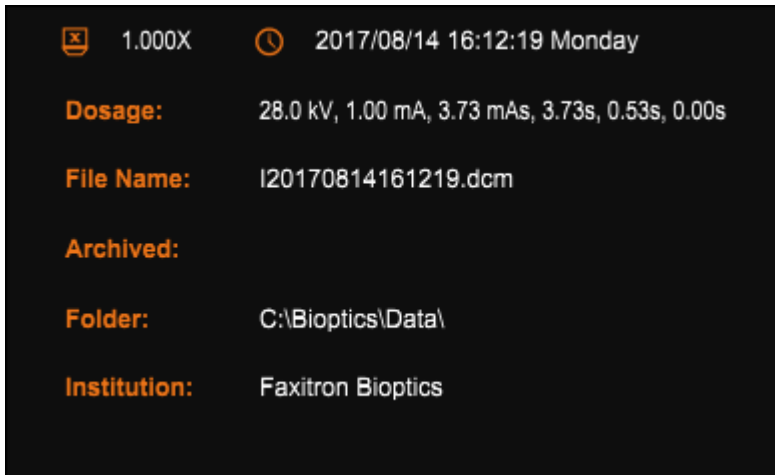

Figure 5.3.4
Image Properties dialog

If the user wishes to change or view the information after it has been input and before an image has been taken, he or she may press the "Patient Data" button in the top left corner, shown in Figure 5.3.5, and re-input the information and accept the changes by pressing the "Accept" button. Other options are to select a new patient or procedure or cancel the changes that have been made:



Figure 5.3.5
Patient Data Icon

If the user wishes to view the information after acquiring an image, the user may access the same Patient Data but instead will be given only two buttons. One to "Close Dialog" and the other, "Start a New Patient or Procedure", which takes the user back to the Patient Data Entry page.

NOTICE: Patient information must be entered before acquiring any images.

Choosing the Select from Database button will display the following page. See *Figure 5.3.6 below.*

5.3.0 Cont.

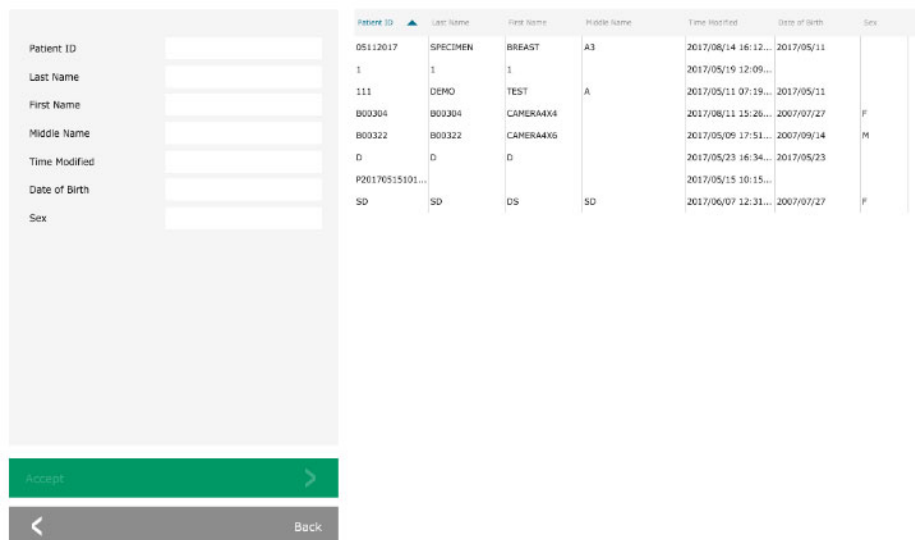

Figure 5.3.6
Selecting Patient From Local Database Entries

The user may filter the Patient Database by typing in the specified entries on the left-hand side. Additionally, the user may single-click an entry in the Database table and press “Accept” to populate the Imaging Information Editor with the patient information.

NOTICE: The user may also double click any entry within the table to quickly go into the Imaging Information Editor without having to press “Accept.”

SELECT FROM WORKLIST (Remote Modality Work list)

Choosing the "SELECT FROM WORKLIST" button will display the following page. See *Figure 5.3.7 below.*

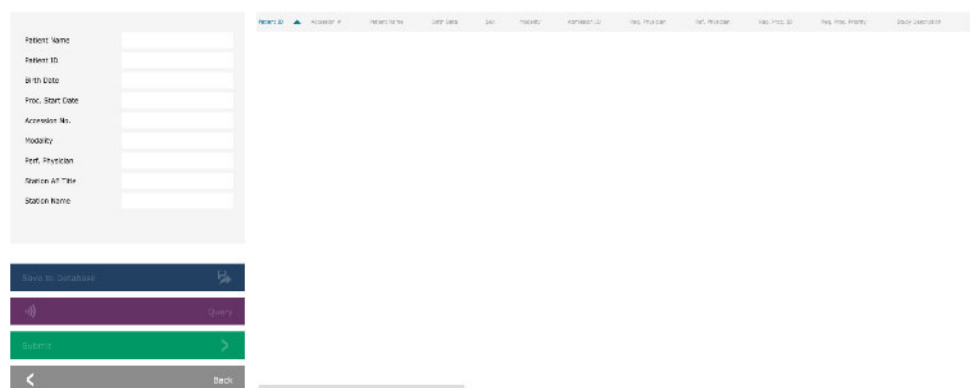

Figure 5.3.7
Modality Worklist Search Dialog

On the left are various filters that may be used to search for scheduled procedures for the Station Application Entity (AE). Verify that the station AE Title is defined, then any single field or any combination of fields may be used as a filter to search for scheduled procedures for this AE. By selecting the "Query" button located in the bottom left corner, the table is re-populated with the entries that match the queried information.

The user can then single-click any entry and hit “Submit” to automatically populate the Imaging Information Editor with the patient information.

NOTICE: The user may also double click any entry within the table to quickly go into the Imaging Information Editor without having to press “Submit.”

The button, shown in Figure 5.3.8, will open the Window Level and Contrast adjustment tool which allows the user to adjust the image's window level and contrast, or adjust it back to the Original Contrast by pressing the "Original Contrast" button, or invert the image by pressing the "Invert" button. Inverting flips the color scheme from being predominantly black to being predominantly white and vice versa.

The user may also adjust the slider bar for desired image contrast by clicking on the bar and moving it up and down or by clicking on any of the indicated arrows on the bar to move the lower or upper window level limits. See Figure 5.3.9 (Informally this is also known as "Window Leveling.").

An example of inverting is shown below:



5.3.1 Inverting, Window Level and Contrast Adjustment

Figure 5.3.8
Example of inverting with the Adjust Contrast / Window Level tool

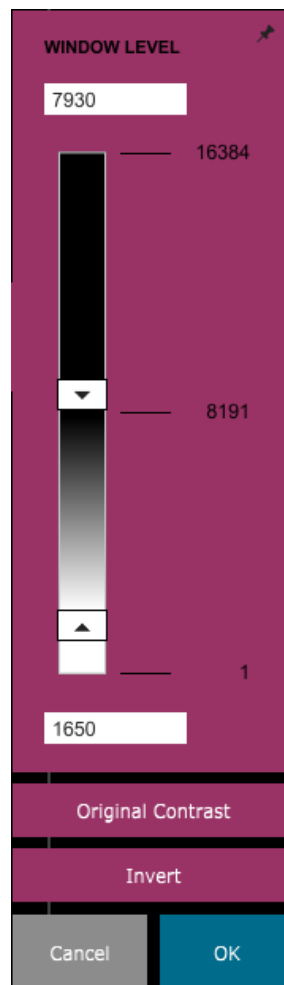
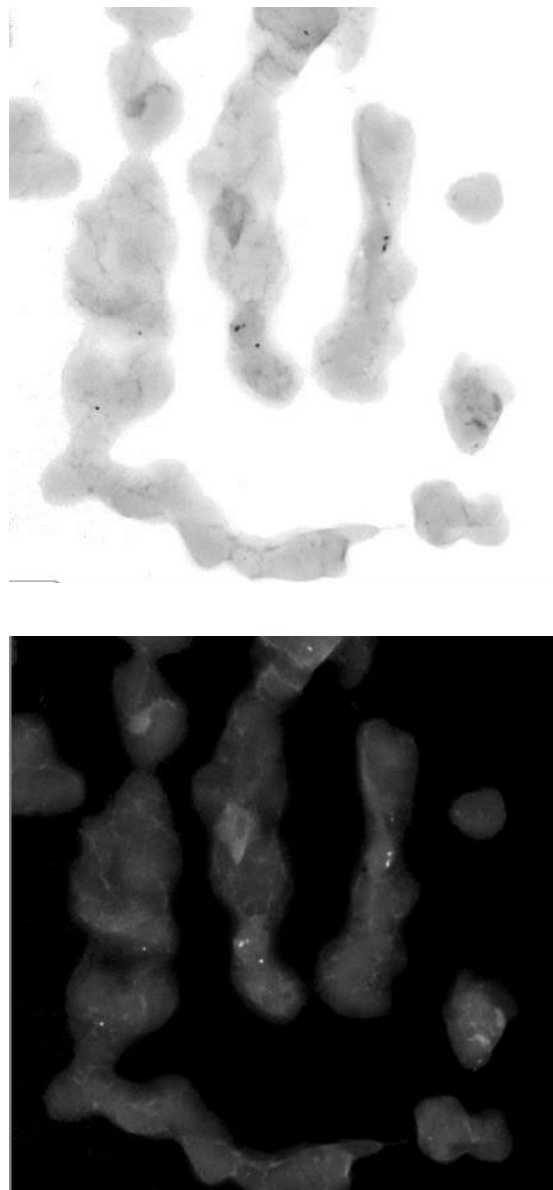

Figures 5.3.9
Example of inverting with the Adjust Contrast / Window Level tool

This button will open the Zoom Adjustment tool. After opening this tool, the user may use the slider bar to adjust the zoom level, fit to the specimen, fit to screen, or zoom 1.0x (full resolution). When the image has been zoomed in, panning is necessary to navigate around the image. A thumbnail dialog will appear in the top left corner of the screen which will allow the user click and hold the left button over the image and move the mouse to move the image around in the main screen.

5.3.2 Dynamic Zoom Adjustment

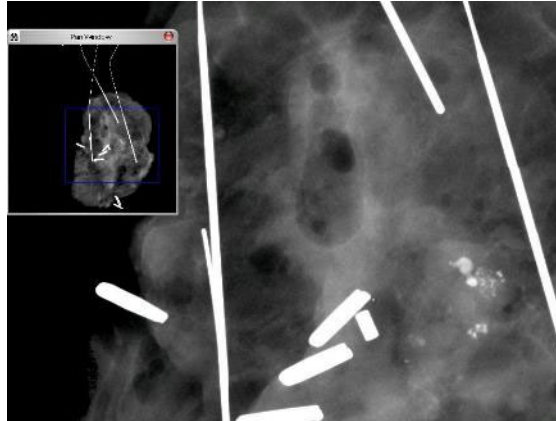
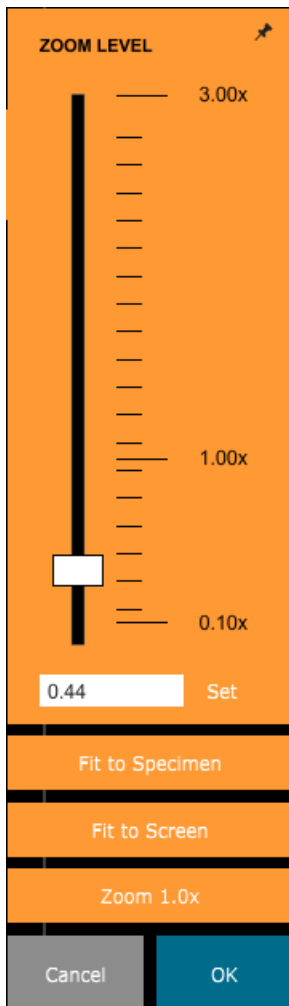

Figure 5.3.10
Zoom tool icon

Figure 5.3.11
Pan View example



Note that traditionally, this feature is also called "Pan View" and/or "Pan and Scan."

The "Fit to Specimen" button will attempt to detect and zoom in onto the specimen as to ensure that the specimen is in full view. If a specimen is not detected, it will default to the previous mode (either "Fit to Screen" or "Zoom 1.0x").

Figure 5.3.12
Zoom Level Adjustment tool

Zoom 1.0x is traditionally called "Full Resolution" as it brings the image to a 1-1 view with the monitor resolution.

Fit to screen fits the image to the screen.

The button shown in Figure 5.3.13 will process the image on the display to emphasize the smaller details such as micro-calcifications and small masses in the image.



5.3.3 Enhance Image

Figure 5.3.13
Image Enhancement icon

The algorithm, commonly known as "Peripheral Equalization" or "Thickness Equalization" in advanced imaging, is applied to the whole image. In addition to this algorithm, Faxitron employs a second, internally developed algorithm called the "Calcification Emphasis" algorithm. This secondary algorithm was made to bring out small details in the image and make them much easier to see and analyze.

Since Patient images constitute a more general category in terms of possible geometries and variety of thickness, there may be some challenging sample geometries and the user should use this tool with care.

The system will be idle (in Standby) during the processing and once completed the button will stay depressed/active. The user can undo the process by pressing the button again.

The button shown in Figure 5.3.14 will open up the annotation tools. These tools and their many features are discussed in further detail in section 5.7.0.



5.3.4 Annotations

Figure 5.3.14
Annotations icon

The button shown in Figure 5.3.15 will only function when the system is installed in a medical facility with a PACS network. To save your files locally, please refer to section 5.5.0.



5.3.5 PACS Store

Figure 5.3.15
PACS Store icon

The button shown in Figure 5.3.16 will only function when the system is installed in a medical facility with a PACS network. For local printing please refer to section 5.5.0.



5.3.6 PACS Print

Figure 5.3.16
PACS Print icon

The button shown in Figure 5.3.17 exits the image acquisition mode and returns to the Main Menu screen.



5.3.7 Back to Procedure

Figure 5.3.17
Back to Procedure icon

The button shown in Figure 5.3.18 will open the Device Control Panel, which allows the device user the convenience of controlling the X-Ray system through the software. The user can easily select the Exposure Mode, X-Ray Tube kV setting, Exposure Time, and the number of images to acquire for Image Averaging (if desired), and initiate the X-Ray exposure. Additional options, such as Floro Mode, may be available depending on the system.



5.3.8 Device Control Panel

Figure 5.3.18
Device Control Panel Icon

For soft tissue imaging, like breast specimens, the Full auto mode is the best setting. The system will take a pre-shot and calculate the best exposure setting for the tissue.

For samples with large regions of higher density, for example bone, manual setting will be more suitable. Start with a Full Auto images and then if required switch to Full Manual and adjust kV to get more penetration on the denser areas and increase time to get a brighter overall image (higher ADU).

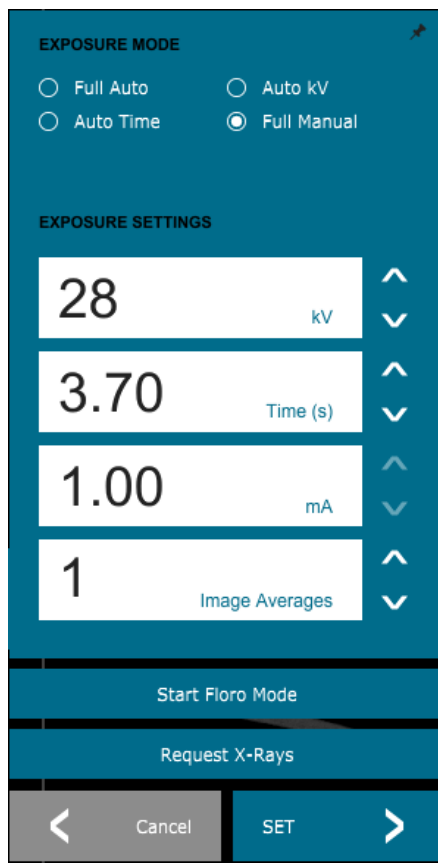

Figure 5.3.19
Device Control Panel

5.3.9 Shutdown

Turn the key to the “OFF” Position to shut down the system. Wait 30 seconds for the computer to shut down.

Additional dialog notes

When a dialog is opened, it is “docked” to the left side of the screen. If a user wishes to undock the dialog box, they may click the top-right “Pin” icon to undock the dialog box and be able to drag the box freely. The “pin” then turns into a “X” icon allowing for quick closing.

Users can also quickly navigate between the various dialogs by clicking through the left menu. By doing so, the left menu will quickly close and open the applicable dialogs as appropriate.

View Display

5.3.10 View Display

In the Main Menu, is the View Menu which gives the user various options which are described below.

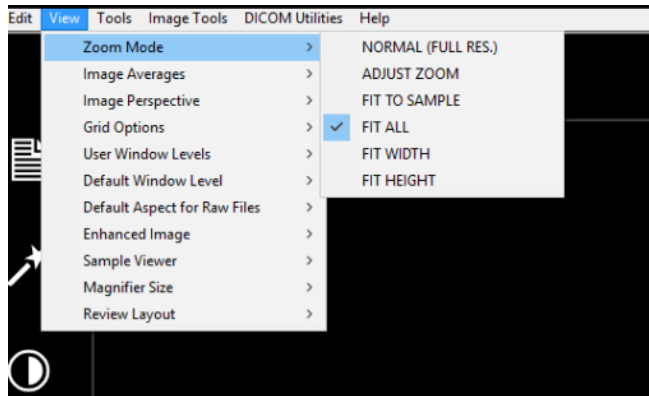

*Figure 5.3.21
View Menu*

Zoom Mode

Normal

Displays the acquired image in its native format and for large area images, scroll bars are provided to view the image, as the image exceeds the available graphics area. The middle scroll button on the mouse may be used to scroll up and down the display area.

Adjust Zoom

This option enables the Adjustable Zoom dialog and subsequent

Fit All

This option displays the entire acquired image, regardless of its native format. The Full Resolution option does not work in this view mode.

Fit Width

This option displays the acquired image across the available width of the entire display area.

Fit Height

This option displays the acquired image across the available height of the entire display area.

Other Options

Image Averages

This option allows the user to adjust the number of image averages to be taken per an exposure.

Image Perspective

This option allows the user to rotate the displayed image to 0, 90, 180 and 270 degrees in orientation.

Grid Options

5.3.10 Cont.

When an image is displayed, either as an acquired image or a retrieved image from the database, the user may activate a grid. Also allows the user to set grid spacing (pitch). See example below.

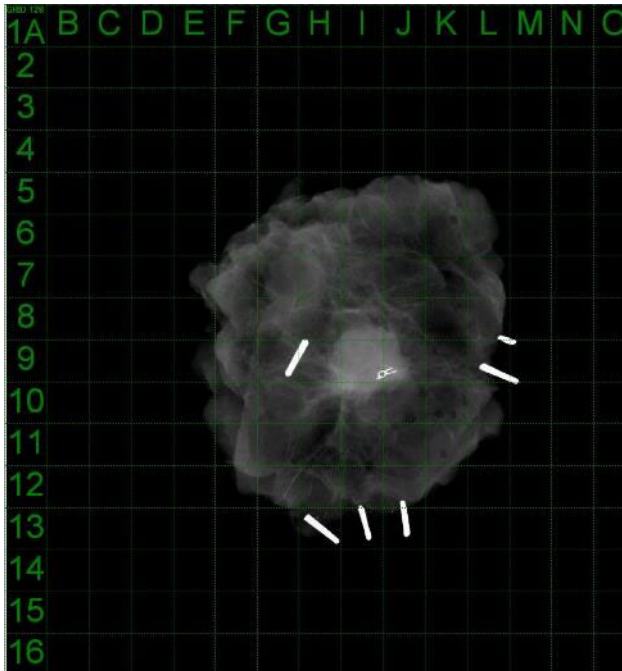

Figure 5.3.22
Sample grid display

User Window Levels

This allows the user to define up to three (3) pre-defined, user set Window Levels (WL). First select the Window Level button. Adjust the WL to the desired level. From the "View" tools, select the "User Window Levels". Select "Record Current WL as USER WL #1, #2 or #3". The adjusted WL will be saved under the choice previously selected.

Default Window Level

The user has two choices of default window levels (WL). Optimize for whole area. This adjusts the WL for the entire image. The Optimize for sample, adjusts the WL for under the sample area only. Additionally, there is an option to set the Default Window Level which is used for all obtained images located here as well. This will set the default window level based off of the image statistics and will need to be done for the un-enhanced and enhanced images separately.

Default Aspect of Raw Files

This tool is placed under the VIEW menu. It helps importing/opening of previously saved image files with unknown file attributes or binary image data without any header information. Since, exact imager array size is not available from header of image data file, a closest fitting imager dimensions will be used to import/open such images, based on width being larger or smaller than height (default aspect information).

Enhance Image (same as the Enhance Image button)

5.3.10 Cont.

Processes current Patient image and enhances visualization of tissue located near the periphery of the sample.

Sample Alignment

In the event that the system has a web camera, this toggles the systems' web camera viewer to allow for specimen orientation and alignment.

Review Layout

Helps user configure multiple image panes in the Review (Database) Mode of program. Available options are dual horizontal, dual vertical, triple and quadruple layout. During multiple pane operation, the user can click on desired pane/image once to make it current selection, the current selected pane will get green rectangular border around. The images in database list view or database thumbnail view will be opened into current selected pane when double clicked on them. User can also open the images into desired panes directly from right click menu of the mentioned database views. After right click menu activated, the user can select from the panes listed under OPEN TO→ which will provide available panes to open the image into (left, right, top, bottom etc).

5.3.11
Tools

The *Tools* menu is located in the horizontal menu found in the upper left hand corner of the main screen.

*Figure 5.3.23
Tools menu*

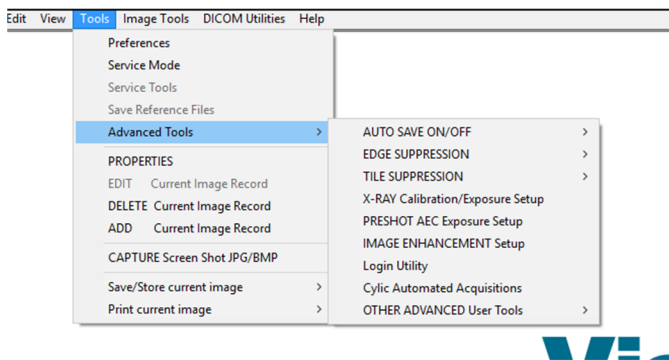

Preferences

This opens the internal configuration management utility which can be used to change various options. NOTE: Changing configuration parameters without proper knowledge or authorization can cause loss of image quality, system damage, and system malfunction.

Service Mode

Service Mode is activated for troubleshooting purposes, allowing the technician access to additional features within Vision software.

Advanced Tools Options

5.3.11 Cont.

The Advanced tools offers various options to configure aspects of the software such as post-processing and configuration options.

Auto Save On/Off

This is placed under ADVANCED TOOLS. When Auto save is "on", all subsequently acquired images are saved to the database written to a Data Directory define in the configuration file.

Preshot AEC Exposure Setup

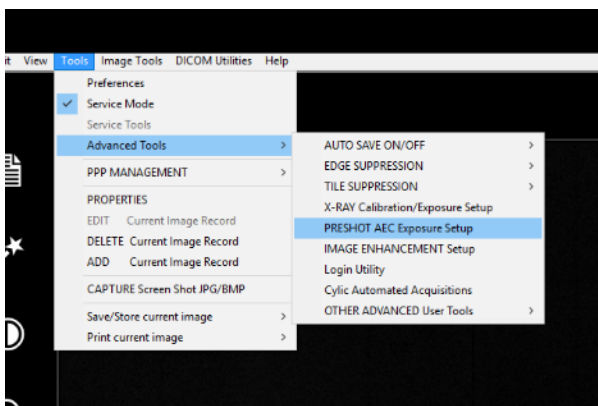

Go to the main-menu, (the menu at the very top of the screen). Choose "TOOLS", "ADVANCED TOOLS" then "PRESHOT AEC Exposure Setup."

Figure 5.3.24
Selecting Preshot AEC Exposure Setup

Enter the PRESHOT AEC values in the window below. Note: the values in the image are examples only. The correct values will need to be input for your particular system.

Figure 5.3.25
Preshot AEC Exposure Setup

For a Faxitron Path+, the options are typically 30kV and 15 seconds for the preshot, with a Target ADU of 8000.

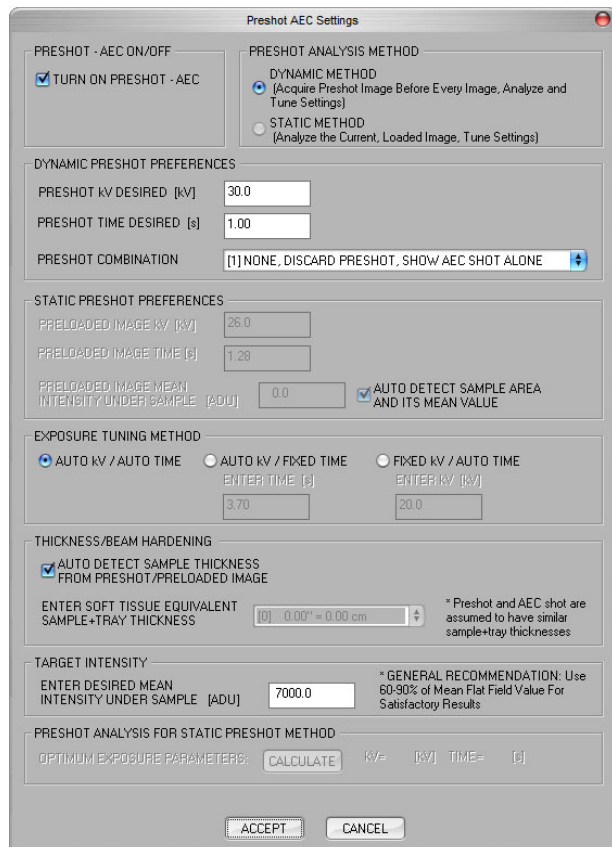

The above settings reflect a 30 kV and 1 second exposure time for the pre-shot setting. Users can enter the selection of pre-shot parameters only with the selection of DYNAMIC METHOD in the ANALYSIS METHOD section. The STATIC METHOD selection will use Faxitron predefined parameters. In addition, the user has the option of selecting the kV and exposure time settings from the EXPOSURE TUNING METHOD section.

For more accurate images, the user can enter the SOFT TISSUE (Sample) thickness and the TARGET INTENSITY in ADUs. NOTE the values in the above image are an example only. The correct value needs to be determined.

For the AUTOMATIC EXPOSURE CONTROL mode, push the START button within the Vision software. The Vision software will perform a pre-shot (a short, low dose, pre-exposure) of the sample to create a Region of Interest (ROI) for obtaining the exposure parameters for the optimum image exposure.

5.3.11 Cont.

Login Utility

This is placed under ADVANCED TOOLS. It helps configure and activate the startup password authentication for the program, if desired. The desired changes will only apply if user password is entered correctly. If password authentication is activated the program will ask and verify the password at the startup of the program and will exit the program if correct password is not given.

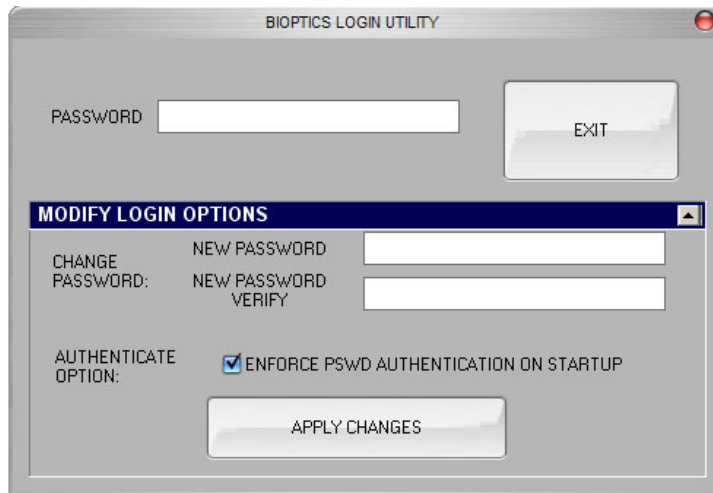

Figure 5.3.26
Login Utility. Same screen will appear during authentication at the startup.

X-Ray Calibration/Exposure Set-up

This is placed under ADVANCED TOOLS. The X-Ray generator/exposure setup aids the user in determining the proper exposure time for a selected kV setting for best image quality. Please refer to section 5.2.1 and Figure 5.2.2 for a more detailed description.

5.3.11 Cont.

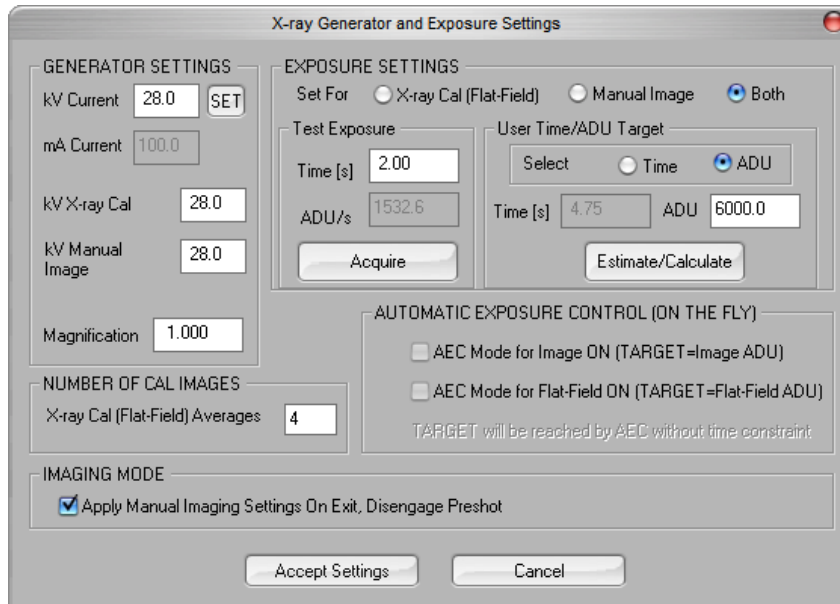

Figure 5.3.27
X-Ray Generator and Exposure
Dialog box

Digital Imaging and Communications in Medicine (DICOM)

Properties

The Properties hides or shows the Sample Information Box.

Edit

Currently not used.

Delete

Deletes the current image from the file directory as specified in the configuration file.

Add

Add the current image to the file directory as specified in the configuration file.

Print Local

Prints current image to WINDOWS printer.

Save Local

The user may "browse" to the directory or file folder to which the image is to be saved. A file name must be assigned in the field provided. Select a file type to save the image as. There are many file types provided. To save the file in a DICOM format, please refer to the "DICOM Functionality" section.

DICOM Local

5.3.11 Cont.

Save, Store and Print

This functionality is applied to the image, which is currently in session. Please refer to the "DICOM Functionality" section for a detailed review of these features.

Capture Screen JPG/BMP

By selecting this menu choice, the user can do a screen capture of the displayed active window. The user can specify a file name and choose between JPG or BMP as the saved file format.

The following features are available to edit the acquired or retrieved image by clicking on the Image Tools menu on the main-menu. See *Figure 5.4.1*.

**5.4.0
Image Tools**

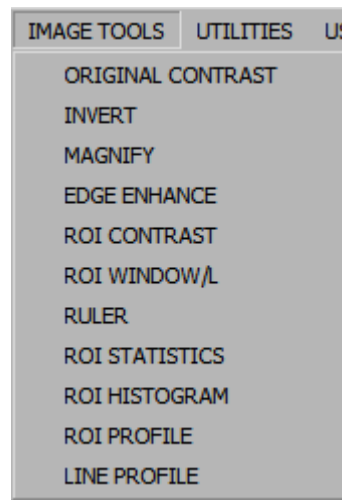

Figure 5.4.1
Image Tools Menu

By selecting the *Original Contrast* from the Image Tools menu, the image contrast levels will be restored. Same behavior as the Original Contrast button.

**5.4.1
Original Contrast**

By selecting Invert from the Image Tools menu, the displayed image will become inverted or reversed. Inverting an image reverses its transparency: what is black becomes white and what is white, becomes black. Grays are assigned their mirror transparency. Click Invert again to turn off the feature. Performs the same function as the Invert button.

**5.4.2
Invert**

Selecting Magnify from the Image Tools menu allows the user to magnify an area of interest. To use the Magnify feature, place the mouse cursor over the desired area to be magnified and click the left mouse button. The area of interest will be magnified. Click Magnify again to turn off the feature.

**5.4.3
Magnify**

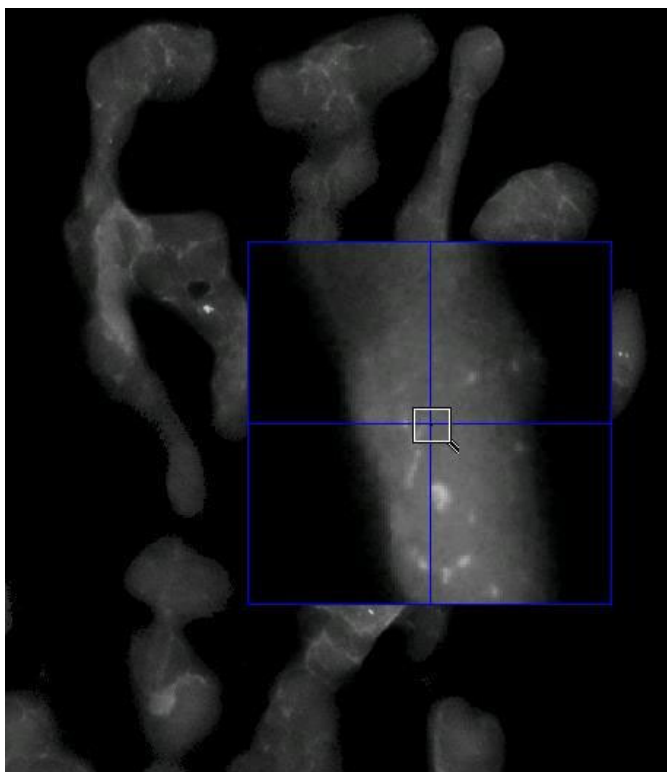

5.4.3 Cont.

Figure 5.4.2
Magnify

Selecting *Edge Enhance* from the Image Tools menu, will create a sharper definition around edges of regions with a contrast difference. Edge Enhancement may amplify the noise in the images in general. Selecting the menu item again will turn off the edge enhancement. Selecting the *Original Contrast* button will also restore the image back to its original state. Note this is a **different** feature than the Enhance Image feature.

5.4.4 Edge Enhance

Selecting ROI Contrast from the Image Tools menu will optimize the contrast levels within a user-defined region of interest (ROI). After selecting the ROI Contrast menu button, click and hold the left mouse button at the starting point of the desired ROI, drag the mouse and release the mouse button at the desired ending point of the ROI. The contrast will automatically adjust to the best levels for that ROI. (See the Definitions section for ROI)

5.4.5 ROI Contrast

Selecting the *ROI Window/L* (window Level) function from the Image Tools menu can be used to adjust the image contrast and brightness levels in a user-defined ROI. After selecting the *ROI Window/L*, click and hold the left mouse button at the desired starting point of the desired ROI, drag the mouse and release the mouse button at the desired ending point of the ROI. See *Figure 5.4.3*. To modify the contrast and brightness levels, move the bar up or down. Click ROI Window/L again to turn off this feature. (See the Definitions sections for ROI)

5.4.6 ROI Window/L

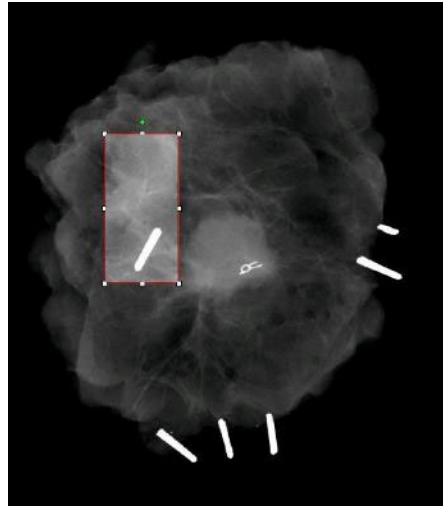

5.4.6 Cont.

Figure 5.4.3
ROI W/L

By selecting Ruler from the Image Tools menu, this will allow the user to measure the distance between two points in the displayed image. Length measurements are in millimetres (mm). After selecting the Ruler from the Image Tools menu, click and hold the left mouse button starting at the point of measurement, drag the mouse and release the mouse button at the ending point of measurement.

5.4.7 Ruler

Measurements (in mm) are displayed on the bottom right side of the graphics window. The Ruler remains active until the user selects another image tool and a line is displayed in red until another action is performed. See *Figure 5.4.4* below. Click Ruler again to turn off the feature.

Hint: To get a perfectly straight line or a line at a perfect 45 degree angle, hold down the SHIFT key (on the keyboard) while holding down the left-mouse button and drag.

5.4.7 Cont.

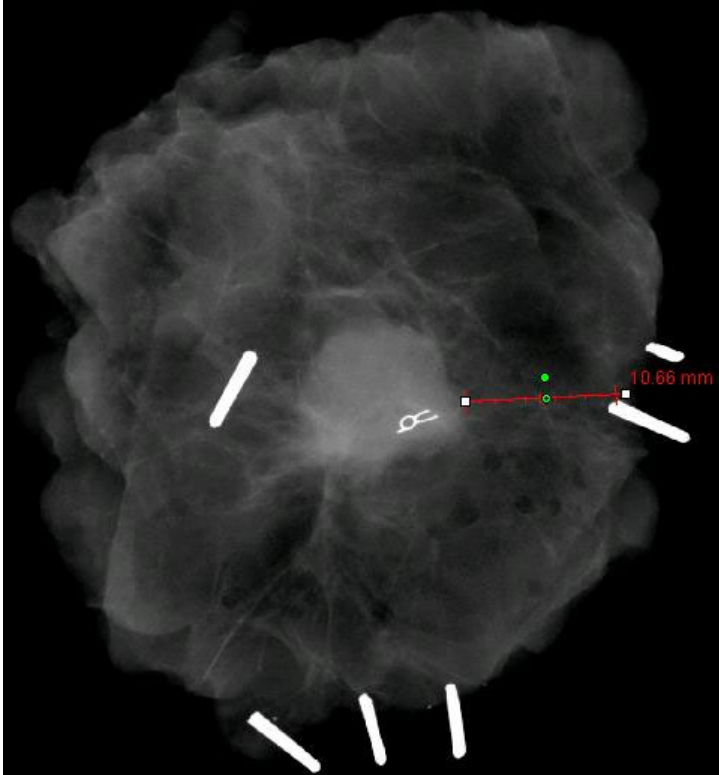

Figure 5.4.4
Ruler

After selecting the ROI Statistics from the Image Tools menu, click and hold the left mouse button over main image's region-of-interest (ROI), drag cursor to make selection around area, then release the mouse button. Statistical information will be displayed for that particular ROI, including Mean, Standard Deviation, Max/Min intensity values and total Pixels. To close the Statistics information box, simply click on the Close button. See *Figure 5.4.5*. Click ROI Statistics again to turn off the feature.

5.4.8
ROI Statistics



Figure 5.4.5
ROI Statistics

The *ROI Histogram* from the Image Tools menu will create a histogram for the ROI the user defines.

After selecting the menu item, place the mouse cursor in the displayed image, press and hold down the left mouse button and drag the cursor to make the desired ROI selection. Release the mouse button. A histogram for the selected ROI will be displayed, see *Figure 5.4.5*.

The Black curve is the Histogram of the selected region. The Blue curve is the Histogram of the whole image. Both curves are normalized against the peak maximum pixel value of the selected region of interest. Click *ROI Histogram* again to turn off the feature.

5.4.9 ROI Histogram

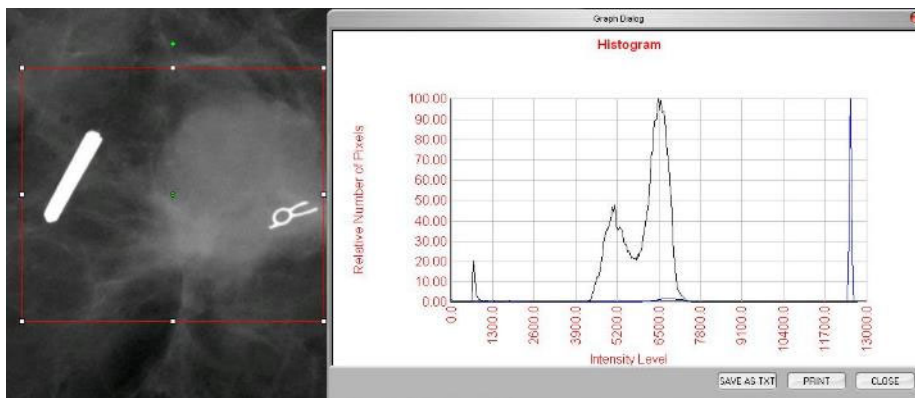

Figure 5.4.6
ROI Histogram

After selecting the ROI Profile from the Image Tools menu, place the cursor in the displayed image.

While holding down the left mouse button, move cursor across the image to draw a user-defined box around the desired ROI. Release the left mouse button and a profile will be displayed showing the individual pixel value of the defined ROI, please refer to *Figure 5.4.7*. By default, the averaging direction of the selected ROI is the short axis. The axis may be toggled back and forth by selecting the SWITCH, HOR<->VERT button. Click ROI Profile again to turn off the feature.

5.4.10 ROI Profile

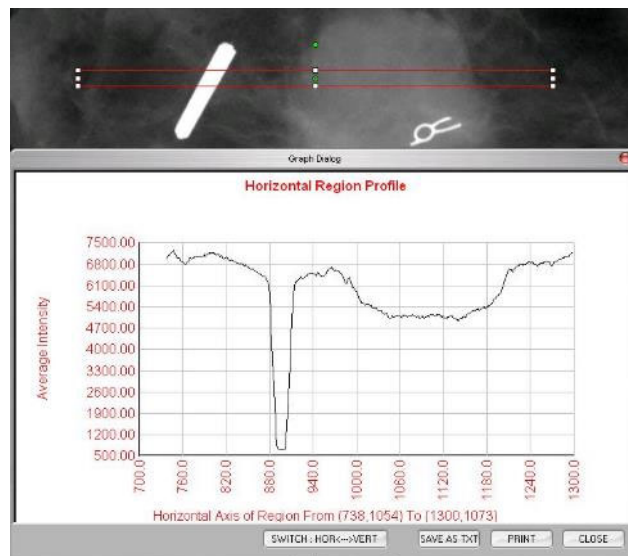

Figure 5.4.7
ROI Profile

After selecting the *Line Profile* from the Image Tools menu, place the cursor in the displayed image.

While holding down the left mouse button, move cursor across the image to draw a user-defined line.

Release the left mouse button and a profile will be given showing the individual pixel value of the defined line, please see *Figure 5.4.8*. By default, the first selected point is always the left most (near origin) portion of the plot (i.e. horizontal axis of the graph can have increasing or decreasing pixel (i,j) indexes, depending on the selected start/end points). Click *Line Profile* again to turn off the feature.

5.4.11 Line Profile

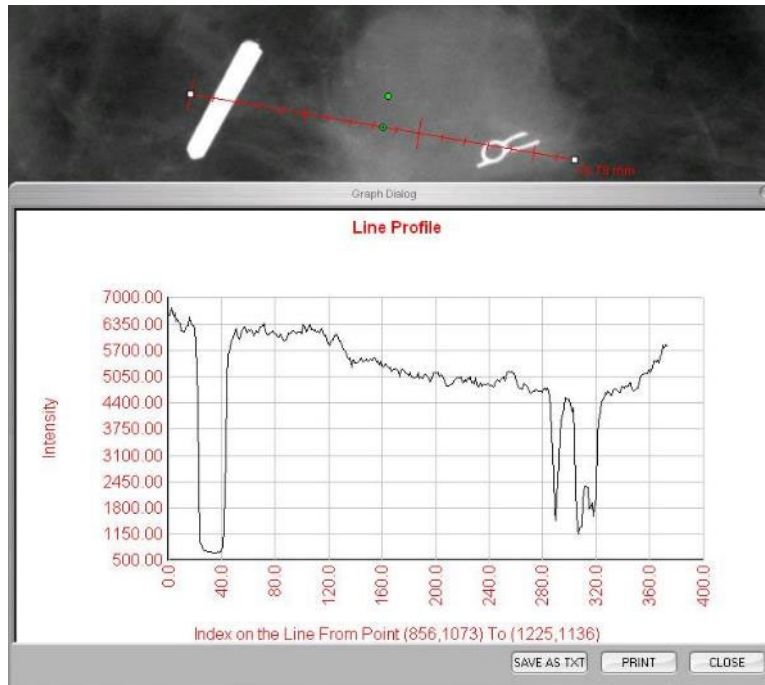

Figure 5.4.8
Line Profile

This feature is an "automatic" feature. This is no button or menu item to select it. Once an image has been acquired or retrieved from the database and is displayed on the screen, a built-in Windows Level is available automatically giving the user the ability to adjust the image contrast and brightness levels.

Click and hold the left mouse button over the displayed image and move cursor up and down for brightness/darkness levels or move cursor left and right for low/high contrast. Move cursor until image is at desired levels.

5.4.12 Built-In Window Level

By pressing the button, shown in Figure 5.5.1, located along the bottom of the image acquisition window, the current patient images thumbnail strip appears.

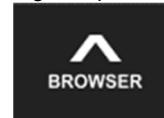

5.5.0 Current Patient Images Browser

Figure 5.5.1
Current Patient Images Browser icon



Figure 5.5.2
Current Patient Images Browser

The thumbnail strip, in orange text along the top, displays the Procedure date for each individual image series.

Highlighted in green will be the current image in the image acquisition window.

The thumbnail strip supports drag and drop operations to place images into the image display or review panes as necessary.

In addition, with a single click, the user can select multiple images and then select from the various options to Save the images to a USB drive, send the images to PACS, or delete the images. Selected images are highlighted in orange.

There are arrows located to the left and to the right. In the event of many images being taken, the user may traverse the images taken, date ascending, by pressing on the left/right arrows.

There is also an option available to Open the Database, which enters Review mode. This same button is the equivalent of pressing "Review Mode" from the Main Menu.

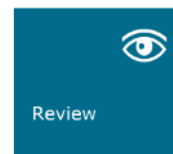

5.5.1 Database

Figure 5.5.3, 5.5.4
Image Database Button in Current Patient Images Browser. On right, the Review Mode icon displayed on the Main Menu.

By pressing either one of these buttons, the system goes into Review mode, keeping the system in Standby, and will display the following tabular structure:

Code: Patient	Procedure	Procedure Date	Procedure Time
00254	0000	2017/01/14 14:02:00	2017/01/14 14:02:00
0113017	0000	2017/01/14 14:02:00	2017/01/14 14:02:00
00	00	2017/01/14 14:02:00	2017/01/14 14:02:00
01	00	2017/01/14 14:02:00	2017/01/14 14:02:00
02	00	2017/01/14 14:02:00	2017/01/14 14:02:00
03	00	2017/01/14 14:02:00	2017/01/14 14:02:00
04	00	2017/01/14 14:02:00	2017/01/14 14:02:00
05	00	2017/01/14 14:02:00	2017/01/14 14:02:00
06	00	2017/01/14 14:02:00	2017/01/14 14:02:00
07	00	2017/01/14 14:02:00	2017/01/14 14:02:00
08	00	2017/01/14 14:02:00	2017/01/14 14:02:00
09	00	2017/01/14 14:02:00	2017/01/14 14:02:00
10	00	2017/01/14 14:02:00	2017/01/14 14:02:00
11	00	2017/01/14 14:02:00	2017/01/14 14:02:00
12	00	2017/01/14 14:02:00	2017/01/14 14:02:00
13	00	2017/01/14 14:02:00	2017/01/14 14:02:00
14	00	2017/01/14 14:02:00	2017/01/14 14:02:00
15	00	2017/01/14 14:02:00	2017/01/14 14:02:00
16	00	2017/01/14 14:02:00	2017/01/14 14:02:00
17	00	2017/01/14 14:02:00	2017/01/14 14:02:00
18	00	2017/01/14 14:02:00	2017/01/14 14:02:00
19	00	2017/01/14 14:02:00	2017/01/14 14:02:00
20	00	2017/01/14 14:02:00	2017/01/14 14:02:00

Figure 5.5.5
Image Database

The Database is basically comprised of three sections or sub-windows. The Patient List Table section, on the left, the Procedure List Table section, on the top right, and the Image Thumbnail List/Viewer section, located bottom right.

5.5.1 Cont.

The list tables work in top-to-down hierarchy as indicated by the arrow:

The Patient List--->Procedure List--->Image Thumbnail List/Viewer.

- The Patient selection window is the upper left most window. The Procedure window is the upper right most window.
- When a Patient field is selected, the Procedure window becomes active. The Procedure window displays a listing of all Procedures performed under the selected Patient. Additionally, all images corresponding to the patient are displayed in the bottom right. It is not possible to select multiple patients.
- When a Procedure is selected, the image thumbnail list/viewer is filtered to only show the images which correspond to the selected procedure. By holding shift, the user may select multiple procedures to view the images for.
- The database may have its sorting adjusted by clicking on the top fields such as Patient ID and Last Name to sort by either one. When the mouse cursor is clicked over one of the database fields, a small arrow indicator is displayed within the field. Using the Left Mouse button and selecting the field again changes the arrow from ascending to descending or vice versa. The field selected will be automatically sorted accordingly.
- Scroll bars are located in the database to allow for ease of navigation.
- The thumbnail list/viewer allows for a user to click on the "+" symbol to automatically add the image to a review pane. A user may add up to four images into the review panes. The review panes are automatically adjusted to encompass the four images.
- The same options as available in the Current Patient Images Browser are also located at the top of the Database. However, additional options are also made available, described in section 5.5.2.

Important Note: The "thumbnail" images (.PNG) are separate files from the actual image data (DCM, DAT, DMM, RAW) files. They have the same file name as the image file, but they have a (.PNG) file extension. It is possible to have an image file and no "thumbnail". In that event, Vision will attempt to create a thumbnail automatically for the image to be loaded into the database. However, if this is unsuccessful, the image will not be displayed.

Save Image(s)

The "Save Image(s)" button is available when an entry from the Image Table or Thumbnail List is selected, or through the current patient images, otherwise it is disabled. The selected image can be saved in the following popular 8-bit image formats: JPEG, BMP, TIFF, RAW. It can also save in 16-bit TIFF format.

The window level of the saved image is the default window level. If the user requires that the window level be arranged, he/she should load the image to the Image View and print from there rather than printing from database dialog.

Send Image(s) to PACS:

This function sends the image(s) to a pre-configured DICOM PACS Server.

Image Database Menu Functions and Tools

There are functions to navigate, search in the database, and to edit, delete, and add records to the database. Those functions are explained through database menu items. They are accessed from the top level button labelled “Additional Options” within the database.

5.5.2 Database Additional Options

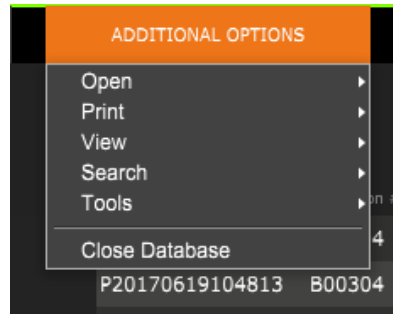

*Figure 5.5.6
Additional Options Menu*

View Menu

Show All DB Entries

Reloads the Patient table from the Database file. Any new changes or additions to the Database will be applied to the table. This selection also clears any active "SEARCH FILTER" which may have been applied to the tables. "SEARCH FILTER" is explained in detail under the DB-SEARCH subject below.

Refresh DB Entries

Refreshes the Patient table, but maintains any existing "SEARCH FILTER" that has been applied.

Browse Data Directory (No DB)

Displays all thumbnail images in the Data directory established by the configuration file. These files are displayed in the Thumbnail Viewer. They are not associated with the Database, or table lists. This tool is helpful to review un-recorded images or debug the database problems with images in the current data directory.

Browse Any Directory (No DB)

Allows user to browse to any file directory. These files are displayed in the Thumbnail Viewer. They are not associated with the Database, or table lists. This tool is helpful to review an image directory which was never recorded in the database or when database records are corrupted.

Search Menu

The database search tools provide detailed searches or database filtering. By selecting the DB-SEARCH menu, a detailed and specific search may be performed. When search criteria is entered and activated in the DB Search Dialog (explained below), the search filter is applied to all list tables on Image Database dialog. The activated search criterion is called "SEARCH FILTER" and this filter remains effective until the user selects "STOP SEARCH" from DB-SEARCH menu or "SHOW All DB Entries" from DB-VIEW menu. The active "SEARCH FILTER" is always shown in the caption of Image Database dialog.

START SEARCH:

"START SEARCH" opens the DB Search Dialog, allowing for individuals to place an active SEARCH FILTER on the database.

Figure 5.5.7
Starting a DB-SEARCH



Drop down menus provide a listing of the search categories. Select a search category and type in the desired search parameter to start the search. Select the Start button to initiate the search. If the category can have more than one discrete entry, all entries for that category will be displayed.

STOP SEARCH:

"STOP SEARCH" disables any active "SEARCH FILTER" and clears all list tables and re-loads the list of all Patients to Patient List Table.

Tools Menu

"DB-TOOLS" menu provides per Image/Procedure/Patient functions as well as some useful functions to repair or reformat the database.

ADD Record:

Available when entry from Image Table or Thumbnail List is selected, otherwise disabled. This is especially useful when a directory is browsed without database having entries available for images in that directory. The user can select a single image from the thumbnail list and add records of that image into the database. If the database entry already exists for the selected image, it will not do any harm, it may only update the database in terms of where the image file is currently located i.e. file/folder name.

EDIT Record:

"EDIT Record" item is available when entry from Patient or Procedure Table is selected; this option is disabled when Image entry is selected. When "EDIT Record" is selected, the Edit Patient/Procedure Properties dialog box will pop up. The user needs to fill in the area according to the selection level which is either Procedure Entry or Patient Entry. The entries on the other level will be disabled. As seen below, when the user selects a procedure entry from Procedure Table to edit, the procedure parameters will be enabled to edit and others disabled (Patient parameters). PatientID is never allowed to be changed.

IMPORT Records in DIR to DB:

This tool helps to browse and select a folder and then to populate the database with all the corresponding entries for all the image files under the selected directory (including subdirectories). The formats for images can be DCM, DAT, DMM, RAW. If thumbnails of images are missing, this tool will also generate BMP thumbnails in the same directory.

REFORMAT ALL DB:

"REFORMAT ALL DB" tool helps to reformat Date [YYYY/MM/DD], Date/Time [YYYY/MM/DD HH:MM:SS] fields of tables and also capitalizes letters of entries for some other fields. It is a useful tool when some older database file is imported and opened for the first time or when the user alters database entries manually using MS Access.

Print Menu

"DB-PRINT" menu provides per Image/Procedure/Patient print functionality

PRINT LOCAL Image:

"PRINT LOCAL Image" item is available when entry from the Image Table or Thumbnail List is selected, otherwise it is disabled. The selected image will be printed using local default printer of Windows system.

The window level of the printed image is the default window level. It is not recommended that users Print from this menu, unless they are satisfied with the print outs set to the default window levels as calculated by the program. The user can load the image first into the Image View(Review) window and then adjust the image to the desired window levels. When satisfied with the window level, the user can then initiate Print from the menu of Image View window. A Format Options dialog provides a choice between printing formats.

PACS PRINT:

This function sends the image(s) to a pre-configured DICOM printer.

Additional Notes on the Database:

- The ability to Exit the database, staying within the Review mode, is located under Additional Options.
- The top-left button will adjust itself to take the user back to acquisition, back to the main menu, or will become the "Close Database" button dependent on the workflow used to enter the Database screen and what is most appropriate.

Difference between PRINT and PRINT LOCAL or SAVE and SAVE LOCAL:

As well as "PRINT LOCAL..", "SAVE LOCAL.." and "DICOM SAVE LOCAL..", there will be so called "unspecified" PRINT and SAVE drop down menu options or buttons. These menu and button tools will prompt the user to select whether to PRINT on the LOCAL system (provided by Windows System infrastructure) or DICOM Networking environment (provided by this program's DICOM Networking infrastructure) and whether to SAVE the image in an 8-bit JPEG, BMP, TIFF, RAW format or in a 16-bit DICOM or 16-bit TIFF format.

The DICOM Standard

What is the DICOM Standard?

**5.6.0
DICOM
Functionality**

The Digital Imaging and Communications in Medicine (DICOM) Standard is a series of protocols used by medical equipment and software to allow data to be compatible and interchangeable with other medical equipment or software.

When a file is saved in a DICOM format, a file is created that includes relevant Patient data, imaging equipment and hardware data, and image data, all in a single file. Additionally, the saved file contains specific characteristics that identify it to computer and software as a DICOM Standard file. Once a software application recognizes the file as a DICOM Standard file, it can initiate a DICOM reader and extract the data properly, regardless of the file's origin.

A file created using the DICOM protocol has the following structure:

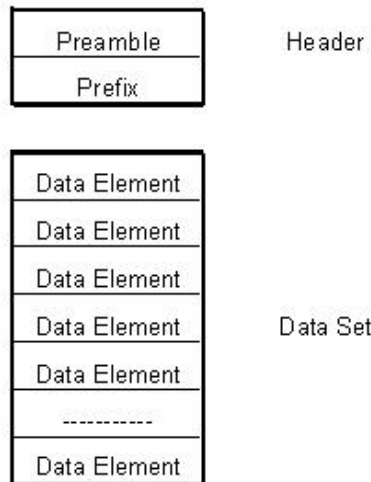

Figure 5.6.1
DICOM Protocol Structure

Where the Preamble consists of 128 bytes, all typically set to 00H unless it is not use by an Application Profile or a specific implementation; the Prefix consists of 4 bytes, making up the character string "DICM" encoded as uppercase characters of the ISO 8859 G0 Character Repertoire; and the Data Elements are arbitrarily large (or small) and contain the data.

5.6.0 Cont.

Modality

The DICOM file settings for Modality are accessed from the main-menu Tools menu. From the Tools menu, the "DICOM Modality Setup" can be selected.

The DICOM storage type, either Presentation or Processing may be selected. The same Dialog box allows for selecting the DICOM Image Modality, either Digital X-Ray or Digital X-Ray Mammography. The Transfer Syntax and Value Representation are not user definable. They are always assigned to be META HEADER PRESENT, LITTLE_ENDIAN and VR_IMPLICIT.

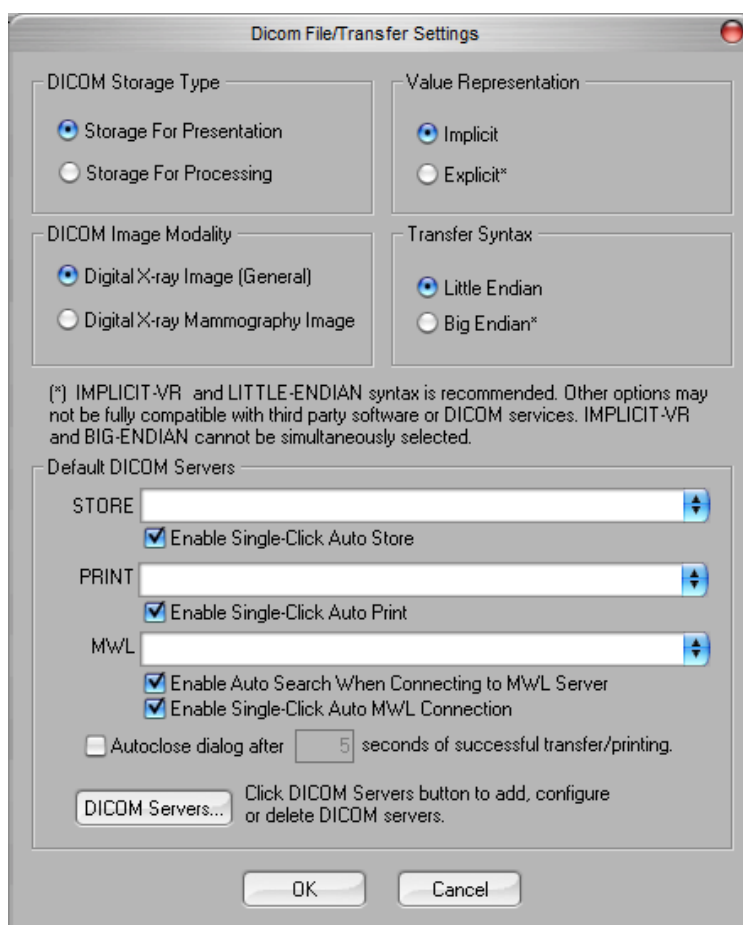

Figure 5.6.2
DICOM Modality Settings
Default settings shown

NOTE: Once the DICOM Modalities have been selected, they remain in effect, even after the Vision software has been closed. The Modality settings are stored and will remain in the configured manner until they are changed again, using the DICOM File Settings. These settings (Storage Type & Modality, Transfer Syntax, Value Representation) will be effective for all DICOM LOCAL SAVE or PRINT functionalities.

Default DICOM Servers

5.6.0 Cont.

This section contains settings for default DICOM servers and to automate some of the processes when storing, printing or searching PACS and MWL servers.

“Enable Single-Click Auto Store”, “Print” or “MWL Connection” checkboxes allow user to store or print images or automatically connect to the MWL server. If you use a single PACS server for those actions or majority of your work involves a single PACS server, check a desired box to automate those actions.

“Enable Auto Search When Connecting to MWL Server” will tell the application to automatically perform a search with default search settings when looking up patient’s data.

“Autoclose dialog after N seconds of successful transfer/printing” will automatically close the DICOM Networking dialog after specified number of seconds passed. The dialog will not close automatically if there was an error with transfer or printing.

Clicking the “DICOM Servers” button will open DICOM Networking dialog, where a user can add, modify or delete DICOM servers.

Saving a DICOM File

This command option appears in several places within the Vision software, review "DICOM SAVE LOCAL".

DICOM SAVE LOCAL

The DICOM Save option (which is provided at various locations throughout the Vision software) displays the following window. The user may enter the File name under which the procedure information is to be stored. Additionally, the user may select the folder in which to save the file.

PACS STORE and PACS PRINT

The Vision software allows for PACS (DICOM) Store and PACS (DICOM) Printing. These options are available throughout the software. For example, if the PACS Store button is selected, the following DICOM Networking Dialog window can be displayed.

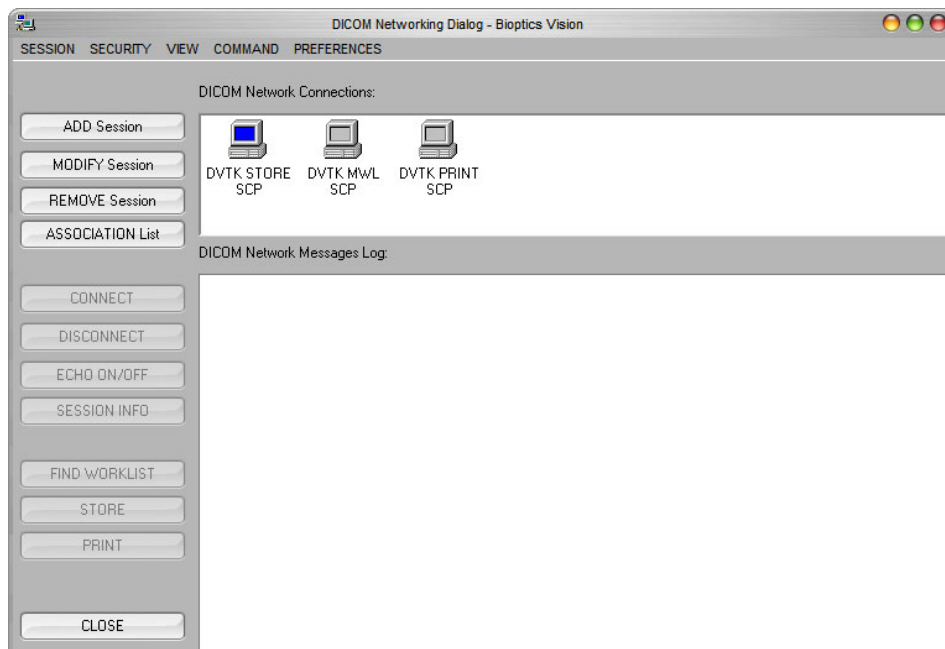

Figure 5.6.3
DICOM Networking Dialog
box

From this displayed Dialog box, the user may choose to do a DICOM Store or DICOM Print. This Dialog box enables the user to Add, Modify or Remove DICOM Network connections or Peripherals.

5.6.0 Cont.

PACS DICOM STORE

The Vision software supports DICOM 3.0 C-STORE Service. This allows for sending an image or a series of images (under a specified Procedure) to a remote DICOM Application Entity (AE) compliant storage system such as PACS. Again, the DICOM Store capability is provided for throughout the Vision software. Modifications to the Presentation and Processing may be made through the DICOM Modality Setup, under the Tools menu. Note: For DICOM Store, the "SET FILM Attributes" will be grayed out.

The user can add a new configuration for a remote DICOM AE to which to send the image or select from an already configured one, shown under the DICOM Network connections, in the DICOM Networking Dialog. By double clicking (or single click, followed by pressing the Connect button) the icon for the remote DICOM AE, the Vision software will connect and establish a DICOM association with the selected remote AE. Once the association is successfully established, the image can be sent for storage by pressing the Store button. After the Store button is selected, the Vision software will send the selected image to the defined remote DICOM AE. If the Store operation is successful, the remote DICOM AE will send a confirmation of reception and storage of the image(s). If the operation fails, the remote DICOM AE will send an error code indicating the reason for failure.

A single image can also be sent for storage by clicking the Right Mouse button on the image "thumbnail" while in the Database Browser and following the same procedure described previously. It is possible to send a whole Series (Procedure) of images for storage. This is accomplished by clicking the Right Mouse button on the Series (Procedure) name, displayed in the Database Browser screen and again, following the same protocol described above.

Add Session

The Add Session button opens the Session Dialog box through which the user can configure a new connection to a remote DICOM Application Entity.

To create a new connection configuration to a remote DICOM AE, the user must have the following information available: the Application Entity Title (AE Title), the choice of DICOM / PACS "function to perform", the IP Address and the Port Number for the Sever (i.e. the DICOM printer or PACS system).

The AE Title and Port Number of the user's system (i.e. the client) are also required. Complete the appropriate data fields and select OK to create a new configuration.

Choosing DICOM / PACS Default Session Function Behaviour

5.6.0 Cont.

There are currently four (4) types of functions that a DICOM session can represent as a default. These are found in the Function drop-down list (combo box) seen in the figures below. A list also follows:

1. A GENERAL DICOM / PACS Connection
2. A DICOM STORE Connection
3. A Modality WORKLIST Connection
4. A DICOM PRINTER Connection

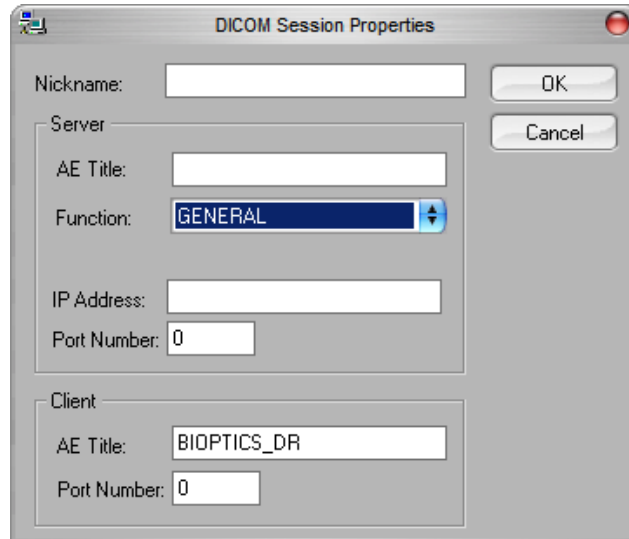

Figure 5.6.4
Session Properties Dialog box

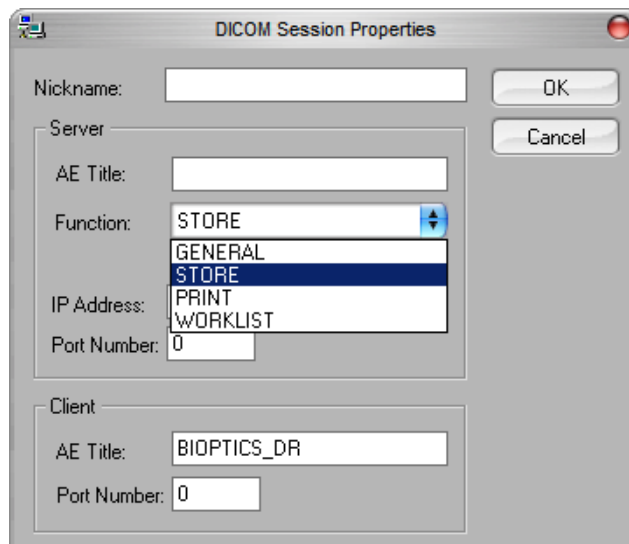

Figure 5.6.5
Functions Shown

The purpose of the DICOM "Function" is to allow a Session/Connection to be created (added) that allows a DICOM / PACS "device" to only be used as the user has configured it for a particular function category.

5.6.0 Cont.

Once configured, when you view or use the "DICOM Networking Dialog," (see *figure 5.6.3 above*) only the icon that matches the function chosen will be "active and lit up." That is, it will have a blue color as opposed to a "grayed out" color. For example, in *figure 5.6.3 above*, we have three (3) icons representing, in order, a PACS Store, a Modality Worklist and a DICOM printer. Because the PACS Store button (see *Figure 5.3.16*) was chosen previously, only the PACS Store icon (DVTK STORE SCP) is active. It works the same for the other modes as well.

Modify Session

The Modify Session button opens the Dialog box for the selected DICOM AE. In this window, the user may modify the Server and Client information described in the Add Session description.

Remove Session

The Remove Session button removes the selected DICOM AE configuration from the Vision software.

Once removed, a DICOM AE configuration cannot be restored unless the user manually re-enters the requisite data through the Add Session button. A confirmation of action will be requested, see below.

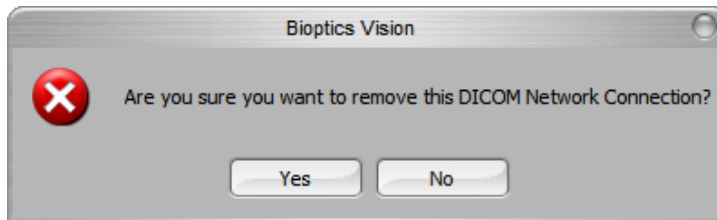

Figure 5.6.6
*Verifying Removal of an Existing
DICOM Network Connection*

Association

5.6.0 Cont.

The Association List button opens the Association Dialog box, depicted below, through which the user can edit the parameters and protocols used by the Vision software when negotiating a connection with a remote DICOM AE. These options should only be modified by an advanced user familiar with DICOM association protocols.

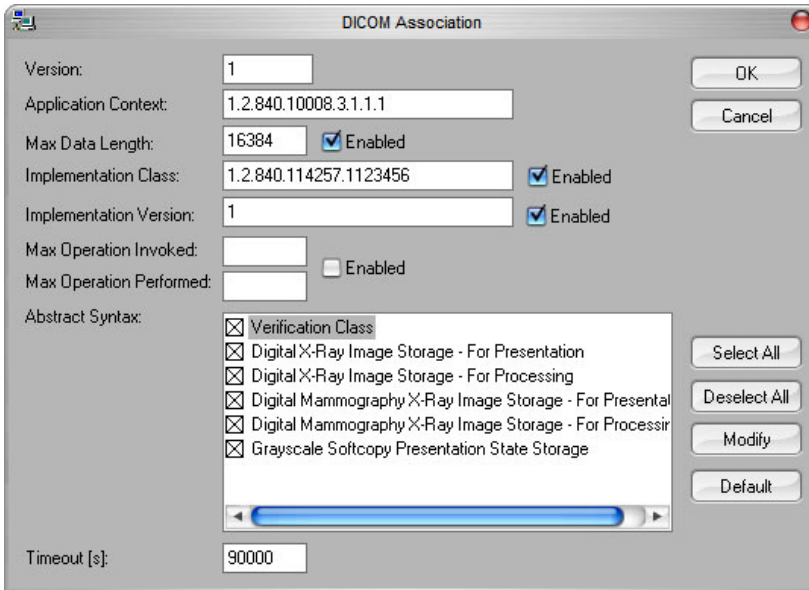
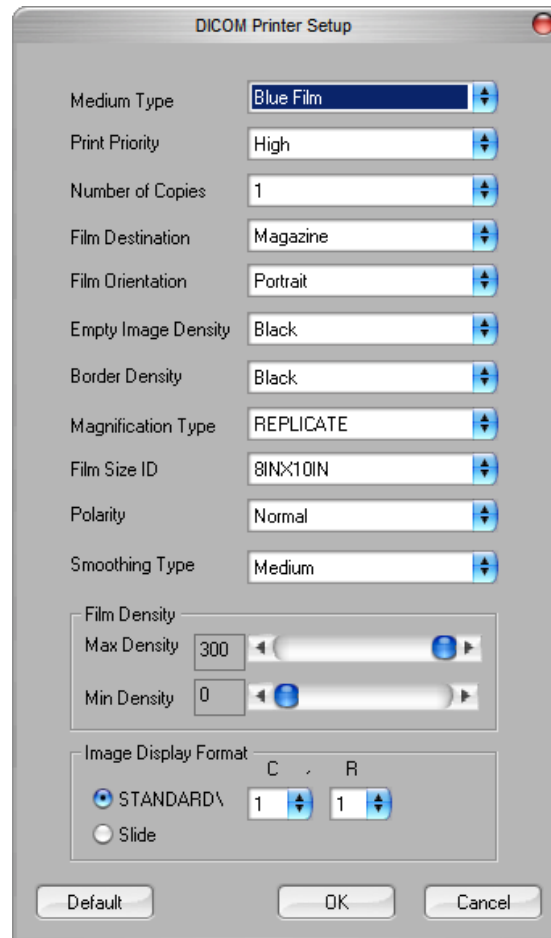

Figure 5.6.7
DICOM Association Window

Film Attributes

Selecting the Set Film Attributes button displays the Film Session Dialog box. In this Dialog box, the user may select various options governing the film and print format. Selecting Default restores all of the default options. Configurations to the settings are provided through drop down menus. To accept the modified configuration, select OK. To reject the options and exit the window without making any changes, select Cancel.



5.6.0 Cont.

Figure 5.6.8
DICOM PrinterSetup Dialog Box

PACS PRINT

The PACS Print option sends the selected image to the selected PACS DICOM printer. The image is printed according to the film and print format options found in the Set Film Attributes Dialog previously described. If the user initiates PACS Print from Image View, then the window level will be chosen from the Image View. If PACS Print is initiated from the Database Dialog, then the Window Level will be the default window level calculated by the Vision software.

Close

The Close button closes the DICOM Networking dialog box and returns the user to the area from which the DICOM command was executed. This command also closes the connection or association between the Vision software and the remote DICOM device if a connection was established.

Overview

User Annotations in the Vision Software allows one to apply a transparent graphic "overlay" commonly called "annotations" to an image. These annotations take the form of text, lines, "free form" lines (Bezier curves), arrows, ellipse and boxes. This allows additional information and "markers" to be added to the image if desired. Note that all annotations can be easily turned on or off, in other words they can be shown or hidden at will.

Operation

To begin annotating, select the "Annotations" tool from the left menu. See Figure 5.7.1 for more information. By opening this dialog, the software will immediately put the user into design mode. It will also display a "Tool Pallet." See below

Selecting "Save" or "Cancel" from this dialog will either cancel the previous annotations or Save the current annotations to the window. It will also return you to normal imaging mode.

The tool pallet consists of fifteen (15) tool options that follow. However, the tools may be truncated based on the needs of the user to the most common 8 tools, which are displayed in the top row of the dialog box. Note the behavior of most of these tool options involve using the mouse to guide the on screen dynamic position and shape. Mouse "clicks" are used to set the final position and shape. The term "swipe" infers holding down the left-mouse button and moving the object around the screen. Letting go of the left mouse, or clicking the right mouse button will "set" the annotation into a "permanent" or final position.

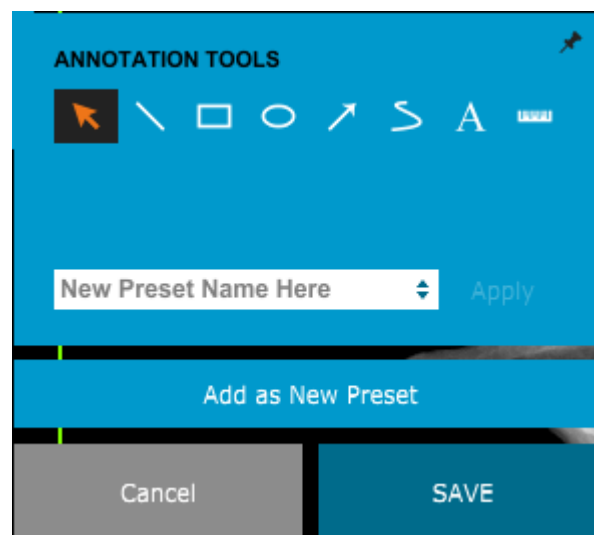

Figure 5.7.1
User Annotation Design
Tool Pallet

Starting from the upper-left of the above figure a description follows of each tool option.

Selection Tool: Use this to select (highlight) a current annotation object. Click and hold the left mouse button down, which sets a starting position, then move the mouse around. Whatever annotations are inside the box being displayed will be selected for further use. Release the left mouse button to finish the operation

5.7.0 Cont.

- **Line Tool:** Draw a straight line with this option. Mouse behavior same as above.
- **Box Tool:** Draws a box. Mouse behavior same as above.
- **Ellipse (and Circle) Tool:** Draws an Ellipse or circle. Mouse behavior same as above.
- **Arrow Tool:** Draws a line with an arrow at the end. Mouse behavior same as Line Tool.
- **Polygon Open Line Tool:** Draws non-straight "open segmented" lines. Left-click mouse, hold button, draw. Release left button, this sets a line segment. Repeat as desired. Right-click mouse button and tool operation is complete.
- **Text Tool:** Creates a "textbox" where you can type text-based data.
- **Ruler Tool:** Creates a ruled line segment. Very much like the Image Tools Ruler feature.
- **Polygon Closed Line Tool:** Draws non-straight "closed segmented" lines. Left-click mouse, hold button, draw. Release left button, this sets a line segment. Repeat as desired. Right-click mouse button and tool operation is complete.
- **Curved Open Line Tool:** Draws curved "open segmented" lines. (Bezier curves.) Left-click mouse, hold button, draw. Release left button, this sets a curved-line segment. Repeat as desired. Right-click mouse button and tool operation is complete.
- **Curved Closed Line Tool:** Draws curved "closed segmented" lines. (Bezier curves.) Left-click mouse, hold button, draw. Release left button, this sets a curved-line segment. Repeat as desired. Right-click mouse button and tool operation is complete.
- **Text "Balloon" Tool:** Creates a textbox with a line segment protruding from a corner of the text box. This can be used to "link" text to something on your image.
- **Segmented Ruler:** Draws non-straight "open segmented" ruled lines. Left-click mouse, hold button, draw. Release left button, this sets a ruled line segment. Repeat as desired. Right-click mouse button and tool operation is complete. The length of all the ruled line segments is shown at the end of the ruler. Useful for a rough estimate of the periphery of an object or Patient.
- **Protractor Tool:** Draws an angle on screen and provides the degree of the angle. Just like a protractor.
- **Orthogonal Ruler Tool:** Provides two (2) ruled lines that are orthogonal to each other.

Design Mode and Mouse Right-Click Menu

5.7.0 Cont.

While in User Annotation Design Mode - but not in a specific operation mode - one can right-click the mouse and get a context sensitive menu. See below.

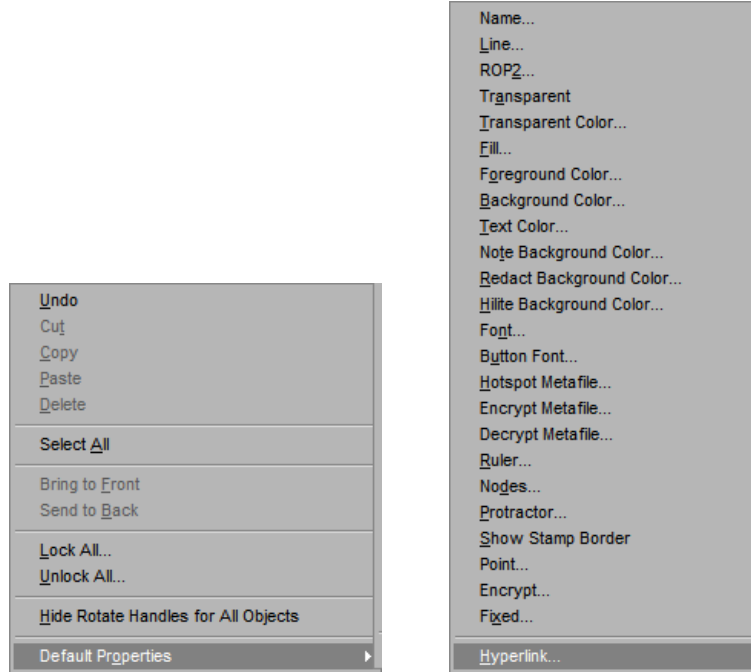

Figure 5.7.2
Right-click Mouse Context Sensitive Menu (Only During Design Mode of User Annotations)

Many specific settings can be made from these context sensitive menus.

Note if an item seems too small to read or see correctly, you can possibly change it from the Right click menus shown above. Alternatively, you can choose to zoom into the image using the Dynamic Zoom tool. This enlarges the image and you should be able to clearly see any annotation.

Show - Hide Annotations

The Toggle Annotations button, shown as Figure 5.7.3, allows users to quickly toggle annotations on and off. By default, the annotations will be toggled on. The button is located in the right-side menu near the upper right corner.

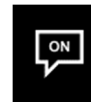

Figure 5.7.3
Show/Hide Option For User Annotations

The Vision Software includes this manual in an electronic copy, accessible in PDF Format, from the top menu under the “Help” submenu.

5.8.0 About Help

The About button opens a Dialog box that shows the Vision software version and copyright date and system information.

5.9.0 About Vision Software

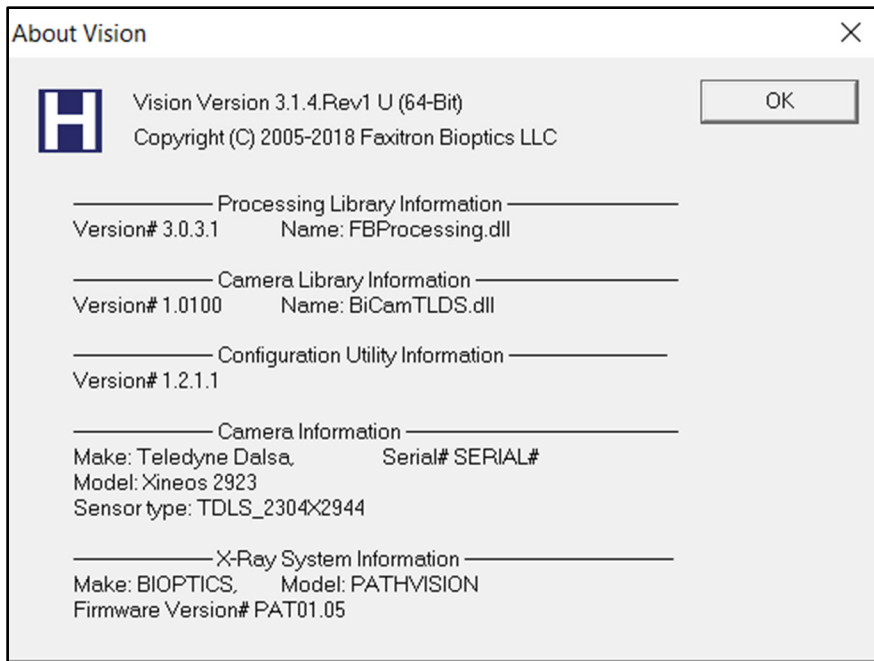

Figure 5.9.1
*About Vision Information Dialog
Box*

6

SECTION 6

Compliance Requirements and Safety Measure

Requirements | Faxitron Path+ Compliance

Emission Limits

Radiation emitted from the Faxitron Path+ unit does not exceed an exposure of 0.1 milli-Roentgen (mR) per hour at any point 5 centimetres (cm) outside the external surface. For countries requiring emission values measured at 10 cm from the external surfaces, the radiation does not exceed 1.0 μ S/hr per hour at 10 cm.

Safety Interlocks

Faxitron Path+ system has two safety interlocks on the specimen door.

Start Button

Following interruption of X-Ray generation by the safety interlocks, the Start button on the front panel will resume X-Ray generation when ready.

Key Actuated Control

Key Lock switch located on the front panel, which requires a key to be inserted and turned clockwise to the 3 o'clock position to provide power to the cabinet system. The key is captive in the "ON" position.

Emergency Stop Button

The Emergency Stop button on the Faxitron Path+ front panel is available to terminate the generation of X-Rays. This is in addition to the safety interlocks on the system doors.

X-Ray Generation Indicators

The Faxitron Path+ has an X-Ray On indicator light on the front panel and graphical user interface, and also produces an audible tone when generating X-Rays.

Power Ratings

100-240VAC 50/60Hz 300W Max.

Tested Standards

Testing carried out by Underwriters Labels (UL), a US Nationally Recognized Testing Laboratory and European Notified Body

IEC 61010-1:2010 Ed.3 Safety Requirements for Electrical Equipment for Measurement, Control, and Laboratory Use - Part 1: General Requirements

IEC 61010-2-091:2012 Ed.1 Part 2-091: Particular Requirements for Cabinet X-Ray Systems

IEC 61010-2-101:2015 Ed.2 Part 2-101: Particular Requirements for In Vitro Diagnostic (IVD) Medical Equipment

IEC 61326-1 Issued: 2012/07/10 Ed: 2 Electrical Equipment for Measurement, Control and Laboratory Use - EMC Requirements - Part 1: General Requirements

IEC 61326-2-6 Issued:2012/07/10 Ed 2.0 Part 2-6: Particular requirements – In vitro diagnostic (IVD) medical equipment

CE Marked

Complies with DHHS radiation performance standards, 21 CFR, Subchapter J

Complies with 21 CFR 1040.10 and 1040.11 except for deviations pursuant to Laser Notice No. 50, dated June 24, 2007

6.1.0

Compliance Requirements and Safety Measures

DICOM Version

Vision uses the latest DICOM standard:
ACR-NEMA Digital Imaging and Communications in Medicine (DICOM) v3.0, Final Draft,
Aug. 1993.

And complies with:
NEMA PS 3.1 - 3.20 (2016), Digital Imaging and Communications In Medicine Set

6.2.0

DICOM Standard

Storage Classes

FAXITRON_DR provides Standard Conformance to the following DICOM V3.0 SOP Class as a SCU.

SCU SOP Class

SOP Class	SOP Class UID
Computed Radiography Image Storage SOP	1.2.840.10008.5.1.4.1.1.1
Digital X-ray Image Storage Presentation	1.2.840.10008.5.1.4.1.1.1.1
Digital X-ray Image Storage Processing	1.2.840.10008.5.1.4.1.1.1.1.1
Digital X-ray Mammography Image Storage Presentation	1.2.840.10008.5.1.4.1.1.1.2
Digital X-ray Mammography Image Storage Processing	1.2.840.10008.5.1.4.1.1.1.2.1
Study Root Query/Retrieve Info. Model -FIND	1.2.840.10008.5.1.4.1.2.2.1
Patient Root Query/Retrieve Info. Model -FIND	1.2.840.10008.5.1.4.1.2.1.1
Modality Worklist information Model-FIND	1.2.840.10008.5.1.4.31
Greyscale Softcopy Presentation Storage	1.2.840.10008.5.1.4.1.1.11.1

For further details refer to the full DICOM Conformance Statement stored on the system. The file is in C:\Faxitron and a shortcut is provided on the desktop.

If required, a copy of the DICOM conformance statement is available from Hologic on request.

7

SECTION 7

Service and Troubleshooting

Service

There are no serviceable parts in the system. Please contact your authorized Hologic representative for servicing.

USA: +1.877.371.4372
Europe: +32 2 711 4690
Asia: +852 37487700
Australia: +1 800 264 073
All Other: +1 781 999 7750
Email: BreastHealth.Support@hologic.com

7.1.0

Service and Troubleshooting

Troubleshooting

Computer or System will not turn on

No power to the computer or X-ray system.

Verify power to system is ON and power cables are plugged in and ON.

READY status does not stay "on"

Button was pressed before Vision Software was running or before software armed the X-ray system for an acquisition. See **Quick Start**.

Image looks like there is another object in

Verify that during "Calibration" that there were no objects in the X-ray cabinet. Remove objects and repeat **Calibration**.

Poor image quality

Verify that the image intensity values (I (x,y)) found in the lower Right-hand corner of the image display window are near the target ADU value of 8000. If needed, repeat the **Imaging** procedure.

No Detector Found on Start-up

The Faxitron Path+ detector, takes up to 60 seconds to be ready for acquisition on first start up. Try closing the software and re-starting.

If that does not work, try turning off Windows Firewall and see if the detector is found. If you require the Firewall to be On contact Hologic to set up the ethernet based detector to allow it to communicate through the Firewall.

Cybersecurity

If a cybersecurity event occurs disconnect the system from the network and contact Hologic immediately. We will work with your IT department to resolve the issue.

A cybersecurity event can be detected in a number of ways:

- Slower than normal operation and/or network connection
- Suspicious pop-ups or home page changed in internet browser
- Password(s) no longer working
- Unidentified programs in start menu or system tray
- Missing, corrupt or altered data

The Faxitron Path+ can operate without the computer and digital detector if the facility has radiological film or CR plate. When the computer is powered down the system will operate in Manual mode where the kV and mA are set using the small touchscreen on the system. Place the radiologic film inside the chamber, place the specimen on top and then expose the film or CR Plate to X-Ray. You may need to work with a radiologist to set the correct exposure.

8

SECTION 8 **Schedule of Maintenance**

This document provides a schedule of testing and maintenance for the Faxitron Path+. It is strongly recommended that the maintenance and tests described in this section be performed at the intervals of time indicated to ensure that your X-Ray generator continues to operate at optimal performance.

8.0.0 Maintenance

Warning: Samples containing tissue can harbor infectious agents that are hazardous to your health. Follow appropriate biosafety procedures; wear gloves when handling tissue specimens or any materials with which they come in contact.



8.1.0 Internal

Wipe down the interior of the cabinet with 70-90% isopropyl alcohol or diluted sodium hypochlorite (5.25%-6.15% household bleach diluted 1:500 provides the proper concentration). Ensure the specimen area, marked on the chamber floor, is thoroughly cleaned.

Do NOT use the following on the specimen door's window:

- Isopropyl Alcohol
- Acetone

Wipe down the system with a moistened cloth with mild soap and water. No harsh abrasives or cleaners should be used on the system to prevent scratching. Do not allow any moisture whatsoever to come in contact with the electrical components of the unit.

8.2.0 External

Detector

1070-7003 PKE XRPAD 4343 F DETECTOR

Computer System

2001-0021 COMPUTER ETHERNET CARD, DELL

2001-0022 COMPUTER, GRAPHICS CARD GEFORCE GT 730

2001-0024 COMPUTER, 64BIT DELL OPTIPLEX XE2

2009-0026 MONITOR, DELL 27 UHD, U2718Q

2013-0018 MOUSE, OPTICAL, WHITE MICROSOFT

2013-0027 KEYBOARD, USA, KSI-U10020-US-HOL-2 (for other languages contact Hologic)

8.3.0 Replaceable Parts

Controller

2001-0034 TOUCHSCREEN, 7 INCH, LCD

43805-65335 PCB ASSY, CONTROLLER BOARD

X-Ray Tube and HV Power Supply

130-552027 TUBE, MICROFOCUS, 100KV MXR

131-10024 HVPS, 100KV GAMMA, MXR & TRUFOCUS

Low Voltage Power Supply

131-20010 SWITCHING POWER SUPPLY ASTEC LPQ252-C

Door Interlock

3101-1989 PLUNGER ASSY, INTERLOCK SWITCH

3101-1990 SWITCH BODY ASSY, INTERLOCK

For other items contact Hologic

- ACR Phantom (Nuclear Associates P/N 18-250)
- Ion chamber Survey Meter, Inovision Model 451B-DE-SI-RYR or similar
- 1 gallon (4 liter) plastic jug of water

8.4.0 Equipment Needed

The following software components are requirement for the system.

Vision Software
Faxitron Processing Library
BiCam Library
Autostart Utility
Optional:
Config Utility

8.5.0 Reference Information

The following definitions apply for the terms listed below when referenced in this Schedule of Maintenance.

8.6.0 Definitions

ACR Phantom- American College of Radiology Accreditation Phantom.

ADU- Analog-to-Digital Units.

AEC- Automatic Exposure Control - Computer terminates x-rays when enough signal has reached the detector.

Contrast: Percent of difference between object intensity and background intensity.

Dark current: Thermally generated signal in the sensor; (almost) linear with time.

Flat-fielding: Gain and offset corrections performed on a pixel-by-pixel basis. Each pixel has a different gain and offset and must be calibrated out.

Line pairs per millimeter: Number of alternating lead and air pieces. For example 10 lp/mm means => {air/lead} {air/lead} ... 10 times in one millimeter.

Magnification: Moving the object away from the detector and towards the x-ray source to magnify the image of the object on the detector.

MTF: Modulation Transfer Function. A measurement of the contrast and resolution of an imaging system.

Read noise: RMS noise measurement in 0-second dark exposure (no signal).

ROI: Region Of Interest. Generally a specific sub-region of an image.

SID: Source-to-image distance; distance from the x-ray source to the detector.

Specimen Radiography: X-ray imaging of a piece of tissue after it is extracted from the body.

The system must be maintained at least once per annum. More regular intervals for radiation surveys and image tests can be conducted by the user in accordance with the instructions in this manual. Refer to local government regulations and facility procedures for further guidance and compliance.

8.7.0 Periodic Maintenance

A radiation survey must be conducted every time the system is relocated or damaged.

Cybersecurity

Any software or firmware updates that have been released since the last maintenance that resolve a safety or security issue can be provided, as necessary.

The firmware is hard coded into the control board so if a firmware update is required, replace the control panel PCB.

Interlocks, lights, Error Messages.

Print this page to use as test documentation if needed.

Record results under “Safety Interlocks and Indicators” on the Periodic Maintenance Record, located at the end of the Section, or on an approved form.

8.8.0

Safety Interlocks and Indicators

1. System must be powered on. The key lock switch should be in the 3 o'clock position with the key captive.

2. Make sure the green “Power” led comes on, and no other LED comes on at this time.

3. Make sure the LCD screen illuminates and displays “System Idle” and there are no other messages, such as “Door Open” at this time.

4. Open the specimen door. The LCD screen will display the message “Door Open”. When the door is closed, this message should disappear.

5. If the software has not already started, double-click the Vision icon. If this initiates a calibration, allow the calibration to fully complete.

6. Next, Click the Start Procedure button, then click the Patient Data button, and choose the Enter Manually button to access the patient entry screen. Fill all fields marked with an asterisk (*), and click the Start button. This will allow for an exposure to be taken.

7. Verify that the green “Ready” LED is on.

8. Press the green “X-ray” button on the touchscreen on the front of the Faxitron Path+. The system should begin taking an x-ray exposure. Make sure

- The Touchscreen LCD displays X-Ray On and displays correct kV and time.
- Software displays X-Ray On (bottom right corner)
- Audible noise heard during entire exposure
- Red “X-Ray On” LED comes on.

Let the exposure finish and make sure the image shows up on the computer screen.

9. Press the green button again to start another exposure. While the exposure is taking place, press the red “Stop” button and the exposure should stop within 2 seconds of pressing the button. Most notably the buzzer will stop sounding to indicate the exposure has stopped. The software will display interruption errors, which is expected. The errors can be cleared which will enable x-rays to be taken.

10. Repeat this test using the software stop button.

11. Press the green button again and let the exposure start. This time, open the specimen door, which should disengage the safety switches and force the exposure to stop. The software may display errors, clear them.

ACR Phantom (Wax Insert Only)

Note: Other test phantoms can be used. Contact Hologic for guidance.

Record results under “ACR Phantom Test” on the Periodic Maintenance Record, located at the end of the Section, or on an approved form.

The user should be familiar with using the Faxitron Path+ and should know the procedures of taking X-Rays. Complete the setup procedures and make sure that the detector is calibrated, (note the calibration kV and time), enter the patient data, and take an image of the wax Insert portion of mini ACR Phantom at x2 magnification. Wax insert needs to be taken out of its acrylic holder.

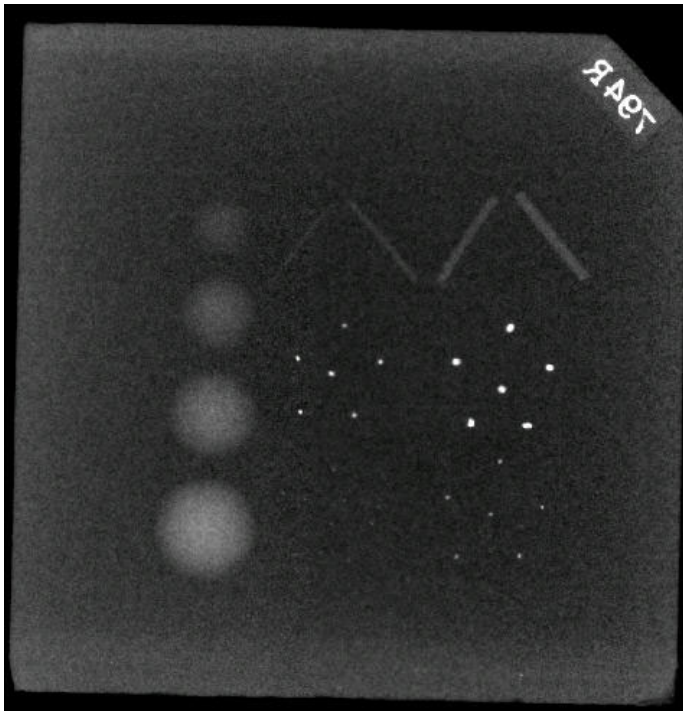

Figure 8.6
Typical X-ray image of mini ACR Phantom (wax insert only)

The Mini ACR Phantom contains 12 objects: 4 masses, 4 fibers, and 4 groups of calcifications (specks). Each calcification group contains 6 individual calcifications or specks.

All masses, fibers, and calcifications must be visible

ACCEPTANCE REQUIREMENTS

1. Configure the system to take a manual image of the wax insert of the Mini ACR Phantom. Set the kV and time to those noted during the calibration.
2. Make sure that the Phantom is clean and free of debris.
3. Place the wax insert directly on the chamber floor in the middle of the image area. Do not use attenuator blocks.
4. Start X-Rays and wait for all processing to be completed and the image to be displayed.
5. All the phantoms' objects may not be visible when the image is first displayed. Adjust contrast and brightness levels as needed for best image
6. Once the image is corrected, all groups of objects should be visible.
8. Record results on the Periodic Maintenance Record.

Figure 8.7
X-ray image of wax insert of the Mini ACR Phantom (Nuclear Associates P/N 18-250).

Radiation Survey

The manufacturer recommends that a radiographic survey be performed at least once a year to ensure that there is no significant excess radiation emission. If the machine is relocated or damaged in any way after installation, the radiographic survey should be conducted prior to putting the machine back into use at the facility.

Record results under "Radiographic Survey" on the Periodic Maintenance Record, located at the end of the Section, or on an approved form.

Required Tools

- Ionization chamber type Radiation Survey Meter with adequate accuracy at maximum kVp and beam quality of the x-ray unit surveyed.
- 4 litre (1 gallon) plastic jug of water.

Verify Survey Meter Operation

1. Calibration date: Make certain that the survey meter calibration is current.
2. Battery Check: Check for proper battery condition. Replace batteries before survey if required.
3. Check Operation: (If check source if available).

Note: The following steps apply to the Inovision 451B or similar Ion Chamber Survey Meters. Follow manufacturers' instructions for other meters.

- Open the sliding Beta Shield on the bottom of the Survey Meter.
- Set the meter down on the Check Source and monitor for 30 seconds.
- Survey Meter should read within tolerance listed on Calibration label.
- Enter the reading on the Periodic Maintenance Record.
- Close the meter's Beta Shield.

Important Notes

1. All radiation measurements are taken with the radiation Survey Meter no more the 2 inches (5 cm) from the surface of the Faxitron Path+ unit.
2. When recording the radiation measurements, they may need to be multiplied by 0.1 to convert the reading from uSv/hr to mR/hr. For example, 12 uSv/hr is equal to 1.2 mR/hr.

8.8.2 Radiation Survey

Radiation Survey Procedure

8.8.2 Cont.

1. Take a background radiation reading (point meter toward the center of the room) and record the value (Note the units used on the Record / Form).
2. Complete a full calibration including a full system warm-up.
3. On the Faxitron Path+ touch screen place the system in Manual mode.

Note: You can turn the computer off by using the software shutdown button in Vision but leave the key in the ON position. This will allow the system to generate X-Rays without the image acquisition, which speeds up the process, but you can also do it in digital acquisition mode (PC On).

4. Open the chamber door. Place the 1 gallon (4 liter) plastic jug of water on the chamber floor imaging area and close the door.
5. Press the "START" button and survey radiation emissions at the top, front, back, and both sides of the cabinet. Slowly scan the entire surface with the meter. It should take 1-2 x-ray exposures to complete each scan. Note: You will have to start x-rays multiple times to complete the entire survey.
6. Record the readings for each test location.
7. If any readings are higher than the Faxitron radiation emission limit of 0.1 milli-Roentgen (mR) per hour (1.0 μ Sv/h) at any point 5 centimeters (cm) outside the external surface (*), contact a Hologic representative to discuss repair options.

(*) 0.5 mR/h at 5 cm from external surfaces is the upper limit by US FDA CDRH for cabinet x-ray systems. If used in another country please check with the hosting country's official limits for cabinet based in-vitro diagnostic radiography equipment.

For some countries, the test points should be at 10 cm from external surfaces and in this case Faxitron radiation emission should read less than 0.1 mR/h at 10 cm from external surfaces.

8. Remove the jug of water from the x-ray chamber.
9. The bottom of the x-ray cabinet should be surveyed again without the water jug. Verify there is nothing in the x-ray chamber, start an x-ray and scan the bottom of the cabinet. Record reading

Periodic Maintenance Record - Faxitron Path+

System S/N: _____

Camera S/N: _____

Safety Interlocks and Indicators – per Section 8.8.0

Pass: _____ Fail: _____ Initials: _____ Date: _____

If failed, state the reason and the actions taken to correct the failure.

Initials: _____ Date: _____

ACR Phantom Test – per Section 8.8.1

Number of objects observed: Masses: _____ Fibers: _____ Calcification Groups: _____

Pass: _____ Fail: _____ Initials: _____ Date: _____

If failed, state the reason and the actions taken to correct the failure.

Initials: _____ Date: _____

Radiographic Survey – per Section 8.8.2

Radiation Readings in: mR/hr μ Sv/hr Check Source: _____ Background: _____

Front: _____ Right Side: _____ Top: _____

Back: _____ Left Side: _____ Bottom: _____

Pass: _____ Fail: _____ Initials: _____ Date: _____

If failed, state the reason and the actions taken to correct the failure.

Initials: _____ Date: _____

The periodic maintenance identified above was completed by: _____

Date Completed: _____ Signature: _____

9

SECTION 9

Revision History

Revision	Date	Description of Change	Author/Originator	Approved by
Draft 1.0	01-May-2018	Engineering Initial Draft	Joseph Mudd	Ciaran Purdy
Draft 1.1	11-Oct-2018	Added detector specifications, EU Rep and updated barcode label	Ciaran Purdy	Ciaran Purdy
Draft 1.2	27-Jan-2019	Add Cybersecurity event detection (7-2) Added interoperable connection descriptions and table (2-2)	Ciaran Purdy	Ciaran Purdy
Draft 1.3	11-Mar-2019	Added DICOM version and storage classes to Section 6	Ciaran Purdy	Ciaran Purdy
001	26-Aug-2019	Updated branding and released for Production Modified certain sections to be consistent with other manuals.	Ciaran Purdy	S. Howerton J. Mudd D. Canny D. Saraiya R. Nash T. Longo
002	July 2021	Added "Follow Instructions" symbol and "package-insert" web address/link Updated Manufacturer and EU Rep Added AU Sponsor and Brazilian Contact Updated table for Warning and Caution symbols on Labels (Section 1.1.1) Deleted images of product labels (Section 1.2.0). Updated "Label Location" figure. Added "Figure Legend and Label Description" to replace images of figures. Updated Service Contact Information	Alan Mihalko	See CCB
003	August 2021	Updated Faxitron Path+ logo from "TM" to ® Changed all occurrences of "Bioptics" to "Hologic" Changed appropriate occurrences of "Faxitron" to "Hologic".	Alan Mihalko	See CCB