

Artwork consists of:

- Sixty 8.5-inch x 11-inch pages graphic attached.

Artwork master disk contains the following file(s):

File Name	Description
AW-14391-002_011_02.zip	Source and supplier print file
AW-14391-002_011_02.pdf	View file

Artwork prints Black.

Die line shown on artwork is for position only and does not print.

REV AUTHORED BY P.CLEMENTI	DATE 01/28/19	HOLOGIC [®]	SIGNATURES ON FILE	
REV DRAFTED BY P.CLEMENTI	DATE 01/28/19			
PROPRIETARY: This document contains proprietary data of Hologic, Inc. No disclosure, reproduction or use of any part thereof may be made except by written permission from Hologic.		TITLE	DOCUMENT NUMBER	REV
		TEXT, MYOSURE SYSTEM OP MANUAL, FMS, EN	AW-14391-002	011
REV. RELEASE DATE:	7 JUN 2019	SIZE A	SHEET 1 OF 1	



Fluent Fluid Management System

Operator's Manual

English

This page is intentionally left blank

Fluent Fluid Management System

Operator's Manual

Procedure Setup:

Introduction	6
Chapter 1: Introduction to Fluent Fluid Management System	11
Chapter 2: Configuring the Touchscreen Settings	17
Chapter 3: Connecting the System Components	18
Chapter 4: Priming the System.....	24

During Procedure:

Chapter 5: Operating the System	25
Chapter 6: Replacing Components	27

After Procedure:

Chapter 7: Disassembly and Disposal	30
Chapter 8: Maintenance.....	32

Troubleshooting

Chapter 9: Notifications and Messages	34
Chapter 10: Troubleshooting	36

Supplementary Information

Chapter 11: Annual Inspection and Testing.....	42
Chapter 12: Technical Specifications.....	43
Chapter 13: Electromagnetic Compatibility.....	45
Chapter 14: Disposables and Accessories	48
Chapter 15: Service and Warranty Information	49
Symbols	51
Glossary	54

This page is intentionally left blank



Procedure Setup

Introduction

This manual is written for medical personnel who will be responsible for operating the Fluent® Fluid Management System. It is extremely important that the operator read and thoroughly understand the contents of this manual, and follow the instructions contained herein for reliable, safe and efficient operation of the product.

RX ONLY (U.S.) Federal law restricts this device to sale by or on the order of a physician pursuant to 21 CFR 801.109(b)(1).

Copyright/Trademark Information

Hologic and Fluent are registered trademarks of Hologic, Inc. and its subsidiaries in the United States and other countries. All other trademarks, registered trademarks, and product names are the property of their respective owners.

Manufacturer

HOLOGIC, INC.
250 Campus Drive,
Marlborough, MA 01752 USA
1.800.442.9892 (US Toll Free)

Indications For Use

The Fluent Fluid Management System is intended to provide liquid distension of the uterus during diagnostic and operative hysteroscopy, and to monitor the volume differential between the irrigation fluid flowing into and out of the uterus while providing drive, control and suction for hysteroscopic morcellators.

Intended Use

The Fluent® Fluid Management System is intended to provide liquid distension of the uterus during diagnostic and operative hysteroscopy, and to monitor the volume differential between the irrigation fluid flowing into and out of the uterus.

The Fluent Fluid Management System is designed to be used in operating room, ambulatory surgical center, and physician's office environments. The gynecologist should be trained in diagnostic and therapeutic hysteroscopy, resection, and removal of gynecological tissue.

Contraindications

The system may not be used to introduce fluids into the uterus when hysteroscopy is contraindicated. See the operator's manual of your hysteroscope for absolute and relative contraindications.

The Fluent Fluid Management System should not be used to remove pathologies from pregnant patients or patients exhibiting pelvic infection, cervical malignancies, or previously diagnosed endometrial cancer.

Relative contraindications to endometrial ablation:

Hysteroscopic endometrial ablation, whether by laser or electrosurgery, should not be undertaken before adequate training, preceptorship, and clinical experience. Additionally, tissue sampling is required prior to destruction of the endometrium. The following are clinical conditions that can significantly complicate hysteroscopic endometrial ablation:

- Adenomatous endometrial hyperplasia
- Uterine leiomyoma
- Severe adenomyosis
- Pelvic pain (subtle PID)
- Uterine anomalies
- Surgical skill (see above)
- Severe anemia
- Inability to circumnavigate the myoma (re: myoma size) - predominantly intramural myomas with small submucous components.

Important User Notes

Read this manual carefully and become familiar with the operation and function of the Fluent Fluid Management System and the accessories before use during surgical procedures. Non-observance of the instructions listed in this manual can lead to:

- Life-threatening injuries to the patient
- Severe injuries of the surgical team, nursing staff, or service personnel
- Damage or malfunction of the system and/or accessories

Essential Performance

Essential Performance of the Fluent Fluid Management System is to provide fluid irrigation and monitor fluid use to prevent unacceptable levels of intravasation.

Warnings, Cautions, and Notes Defined

The words **WARNING**, **Caution**, and **Note** carry special meanings.

WARNING!

Warnings indicate risks to the safety of the patient or user. Failure to follow warnings may result in injury to the patient or user.

Caution!

Cautions indicate risks to the equipment. Failure to follow cautions may result in damage to the system or the potential loss of patient data or system data.

Note:

Notes provide special information to clarify instructions or present additional information.

Warnings and Precautions

The operating instructions in this guide make the system easier to use, while the recommended maintenance procedures help to ensure optimal performance over years of reliable use. As with any surgical instrument, there are important health and safety considerations. These are listed below and highlighted within the text. In order to meet the IEC 60601 safety standard, this console is equipped with an potential equalization conductor which can be used to bring other equipment into the same case potential as the console.

Note:

The following warnings and cautions apply only to the Fluent Fluid Management System. For details, warnings, and cautions on using the hysteroscope and tissue removal device with the Fluent Fluid Management System, refer to the specific documentation for the device.

WARNING!

- Check all factory settings.
- Before using the Fluent Fluid Management System for the first time, please review all available product information.
- Before using the Fluent Fluid Management System, you should be experienced in hysteroscopic surgery with powered instruments. Healthy uterine tissue can be injured by improper use of the tissue removal device. Use every available means to avoid such injury.
- Use only the Fluent Fluid Management System to connect to the MyoSure® Tissue Removal Device. Use of any other drive mechanism may result in failure of the device to operate or lead to patient or physician injury.
- The use of accessory equipment in the patient vicinity not complying with the equivalent medical safety requirements of this equipment may lead to a reduced level of safety of the resulting system. The use of accessory equipment outside the patient vicinity not complying with medical or otherwise appropriate safety requirements may lead to a reduced level of safety of the resulting system.
- The use of an accessory, transducer, or cable, other than those specified by Hologic may result in increased emissions or decreased immunity of the Fluent Fluid Management System.
- Intrauterine distention is usually possible with pressure values between 35 to 70 mmHg. A pressure above 75 to 80 mmHg is required only in rare cases or if the patient has an excessively high blood pressure.
- An air embolism can be the result of air contained in the tube set or connected instrument reaching the patient. Ensure there is always fluid in the bag to prevent air from being pumped into the patient.
- Place the system in such a way as to allow for easy visualization of the display values, system functions, and access to the control elements.
- Pressing the ON/OFF switch does not disconnect the system from the wall power outlet. This requires pulling the power cord located in the rear of the system.
- No modification of this equipment is allowed.
- To avoid the risk of electric shock, this equipment must only be connected to a supply mains with protective earth.
- To avoid risk to patient and operators, do not use this equipment in the presence of intentional magnetic sources, intentional ultrasound sources, or intentional heat sources.
- Consult an expert on electromedicine safety before using this equipment near an RF generator to ensure proper setup and use. If you detect or suspect any interference between the Fluent system and any other medical system, discontinue use of the Fluent system and contact customer support.

- Patient and operators are exposed to plastic (tube set, TRD), metal (console, TRD) and fluid (saline).
- Do not prime inside the patient.

Fluid overload:

There is a risk of irrigation fluid reaching the circulatory system of the patient's soft tissue by passing through the uterus. This can be affected by distention pressure, flow rate, perforation of the uterine cavity and duration of the hysteroscopic surgery. It is critical to closely monitor the input and outflow of the distending liquid at all times.

Fluid deficit:

The fluid left in the patient must be monitored. The deficit is the total amount of fluid left in the patient or unaccounted for otherwise. Take notice of the measurement tolerance of the system. Estimating the fluid volume remaining in the patient is the physician's responsibility.

Fluid intake and output surveillance:

Strict fluid intake and output surveillance should be maintained. If a low viscosity liquid distention medium is used, intrauterine instillation exceeding 2 liters should be followed with great care due to the possibility of fluid overload. If a high viscosity fluid (e. g. Hyskon) is used, the use of more than 500 ml should be followed with great care. See labeling for Hyskon for additional information.

Hyponatremia:

Some distention fluids may lead to fluid overload and, consequently, hyponatremia with its attending sequelae. This can be affected by the distending pressure, flow rate, and duration of hysteroscopic procedure. It is critical to closely monitor the input volume and outflow volume of the distending liquid at all times.

Pulmonary edema:

Hysteroscopic surgery is associated with a risk of developing pulmonary edema resulting from fluid overload with isotonic fluids. It is critical to closely monitor the input and outflow of the distending liquid at all times.

Cerebral edema:

Hysteroscopic surgery is associated with a risk of developing cerebral edema resulting from fluid overload and electrolyte disturbances with hyperosmolar (nonionic) fluids such as glycine 1.5% and sorbitol 3.0%. It is critical to closely monitor the input and outflow of the distending liquid at all times.

Idiosyncratic reactions

In rare cases, idiosyncratic reactions, including intravascular coagulopathy and allergic reaction including anaphylaxis may occur while performing hysteroscopy if a liquid distention medium is used. Specifically, idiosyncratic anaphylactoid reactions have been reported when using Hyskon as an irrigation fluid during hysteroscopy. These should be managed like any allergic reaction.

Hypothermia (monitoring body temperature)

Continuous flow of distention fluids can lead to a lowering of the patient's body temperature during hysteroscopic surgery. Lower body temperatures can cause coronary and cardiovascular problems. Always monitor the patient's body temperature during the entire surgery. Make especially sure that the following, hypothermia promoting, operation conditions are avoided as best as possible: longer operating times and use of cold irrigation fluid.

Rupture of the fallopian tube secondary to tubal obstruction

Distention of the uterus may lead to a tear of the fallopian tube should there be an obstruction or permanent occlusion. The rupture could lead to irrigation fluid flowing into the patient's peritoneal cavity, resulting in a fluid overload. It is critical to closely monitor the input and outflow of the distending liquid at all times.

Original accessories

For your own safety and that of your patient, use only Fluent accessories.

Danger: explosion hazard

Do not use in the presence of a flammable anesthetic mixture. Do not use in the presence of flammable gases or liquids.

Professional qualification

This manual does not include descriptions or instructions for surgical procedures/ techniques. It is also not suitable for training physicians in the use of surgical techniques. Medical instruments and systems may be used only by physicians or medical assistants with the appropriate technical/medical qualification working under the direction and supervision of a physician.

Sterile media and accessories

Always work exclusively with sterile substances and media, sterile fluids, and sterile accessories, if so indicated.

Replacement accessories

In case any of the accessories fail during a procedure, replacement accessories should be kept within easy reach to be able to finish the operation with the replacement components.

Cleaning the system

Do not sterilize the system.

Condensation / Water penetration

Protect the system from moisture. Do not use if moisture has penetrated the system.

System defect

If a system defect is suspected or confirmed, do not use the system. Ensure the system is fully functional as described in Chapter 8: Maintenance.

Replacing fuse

Replace the fuse only with a fuse of the same type and rating. The fuse type is T5AH, 250 V fuses. There are 2 per system.

Single Use

Tubing sets are single use disposables.

Danger: Explosion Hazard

Do not use in the presence of an oxygen rich environment. Oxygen Rich Environment is environment in which the concentration of oxygen is:
a) greater than 25 % for ambient pressures up to 110 kPa; or b) the partial pressure of oxygen is greater than 27,5 kPa at ambient pressures exceeding 110 kPa



Caution!

Electrical Interference:

- Electrical interference with other devices or instruments was practically eliminated when developing this system and none was detected during testing. However, if you still detect or suspect such interference, please follow these suggestions:
 - Move the Fluent Fluid Management System, the other device, or both devices to a different location
 - Increase the distance between devices used
 - Consult an electro-medical expert
- Do not sterilize or immerse the Fluent Fluid Management System in disinfectant.
- Electrical safety testing should be performed by a biomedical engineer or other qualified person.
- This equipment contains electronic printed circuit assemblies. At the end of the useful life of the equipment, it should be disposed of in accordance with any applicable national or institutional related policy relating to obsolete electronic equipment.

Electromagnetic Safety

This section contains important information regarding the electromagnetic safety of this product.

- The Fluent Fluid Management System needs special precautions regarding electromagnetic safety and needs to be installed and put into service according to the electromagnetic safety information provided in this manual.
- This equipment is designed and tested to minimize interference with other electrical equipment. However, if interference occurs with other equipment it may be corrected by one or more of the following measures:
 - Reorient or relocate this equipment, the other equipment, or both.
 - Increase the separation between the pieces of equipment.
 - Connect the pieces of equipment into different outlets or circuits.
 - Consult a biomedical engineer.
- All equipment performance is considered safety-related performance. That is, the failure or degradation of the performance specified in this manual will pose a safety risk to the patient or operator of this equipment.

Note:

If the Fluent Fluid Management System is put into service in accordance to the safety instruction in this manual, the product should remain safe and provide the performance listed above. If the product fails to provide this level of performance, the procedure should be aborted. Contact Hologic. The problem needs to be corrected before continuing or starting a new procedure.

- Portable and mobile RF communications equipment, including cellular telephones and other wireless devices, can affect medical electrical equipment. To insure safe operation of the Fluent Fluid Management System, do not operate communications equipment or cellular telephones at a distance closer than specified in Chapter 13: Electromagnetic Compatibility.
- The Fluent Fluid Management System is not designed to work with or in the vicinity of electrical surgical equipment. If electrical surgical equipment must be used in the same area as the Fluent Fluid Management System, the Fluent Fluid Management System should be observed for proper operation before performing a procedure. This includes operating the electrical surgical equipment in its active mode at a power level suitable for the procedure.
- Use of the Fluent Fluid Management System adjacent to or stacked with other equipment should be avoided because it could result in improper operation. If such use is necessary, the Fluent Fluid Management System and the other equipment should be observed to verify that they are operating normally.
- For more information regarding the electromagnetic safety of this product, please see Chapter 13: Electromagnetic Compatibility.

Chapter 1: Introduction to Fluent Fluid Management System

This chapter introduces the Fluent Fluid Management System by describing all the components for use.

Introduction to the Fluent Fluid Management System

The Fluent Fluid Management System (FMS) is designed to provide liquid distension of the uterus during diagnostic and operative hysteroscopy while monitoring the volume differentials between fluid flowing into and out of the uterus. Additionally, the Fluent Fluid Management System supports the use of the MyoSure Tissue Removal Devices for tissue removal.

Technical application scope of the system

The Fluent Fluid Management System allows intrauterine pressure to be adjusted between 40 and 120 mmHg. The maximum inflow rate is 650 ml/min and is reduced automatically by the pump once the pre-set intrauterine pressure setting has been reached. The system has been designed to provide both fluid and vacuum systems that maximize the performance of the MyoSure® Tissue Removal System.

Suggested distension media

The Fluent Fluid Management System should only be used with Sterile Media. The Fluent Fluid Management System can be used with hypotonic, electrolyte-free media (e.g., glycine 1.5% and sorbitol 3.0%) and isotonic, electrolyte containing media (e.g., saline 0.9% and Lactated Ringer's). See "Introduction" section for risks related to Viscosity and the use of a high viscosity media such as Hyskon under "Fluid intake and output surveillance."

Pressure measuring and regulating

The system operates with a completely non-contact pressure measurement of the irrigation medium. The pressure control circuit continuously compares the desired preset intrauterine pressure with the actual intrauterine pressure. The function of this algorithm is to maintain the pre-set intrauterine pressure.

Components Included With the Fluent Fluid Management System

This section lists and describes the Fluent Fluid Management System components.

- | | | |
|-----------|---|---|
| 1 | Fluid Bag Hooks | Location to hang up to 6L of fluid |
| 2 | Fluid Bag Pole | Contains two IV Hooks to hang up to 6L fluid |
| 3 | Touchscreen Monitor | Allows configuring, adjusting, and monitoring the status |
| 4 | Fluent In-FloPak Receptacle | Location to insert the Fluent In-FloPak |
| 5 | Fluent Out-FloPak Receptacle | Location to insert the Fluent Out-FloPak |
| 6 | MyoSure Tissue Removal Device (TRD) Connector | Location to connect the MyoSure TRD drive cable to the Fluent Fluid Management System |
| 7 | Foot Pedal Connector | Location to connect the MyoSure Foot Pedal cord to the Fluent Fluid Management System |
| 8 | Waste Bag Hanger | Location to hang a Waste Bag |
| 9 | Waste Bag | Waste Bag |
| 10 | Wheels | Enables movement and positioning of the Fluent Fluid Management System |
| 11 | Wheel Locks | Prevents movement and positioning of the wheels |

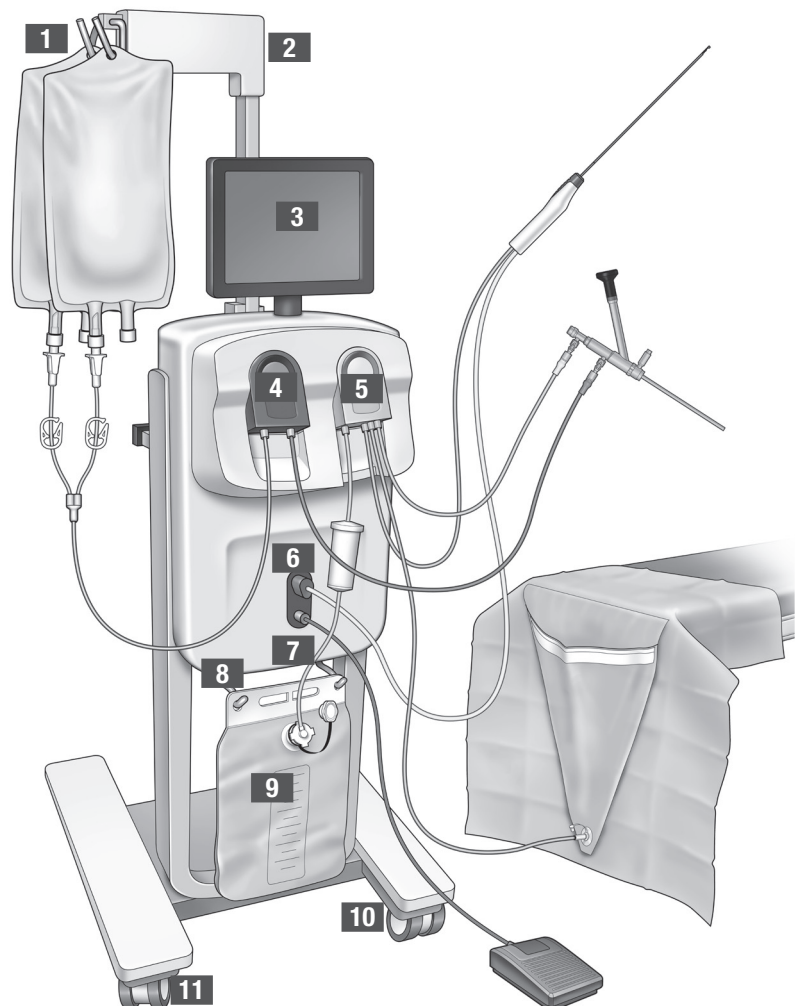

Figure 1: The front of the Fluid Management System console with corresponding component parts attached

The following illustration shows the components on the rear of the Fluent Fluid Management System console.

- | | | |
|-----------|-----------------------------|--|
| 12 | Handle | <ul style="list-style-type: none"> - Grasp to move and position the System - Location to wrap the Power Cord when not in use |
| 13 | On/Off Switch | Turns the System On (I) and Off (O) |
| 14 | Power Port | Location to connect the Power Cord to the System |
| 15 | Equipotential Plug | Connector used to electrically bond the system to another conductive material, or ground the system to a safety ground. |
| 16 | Storage Basket mount points | Location to hang Storage Basket |

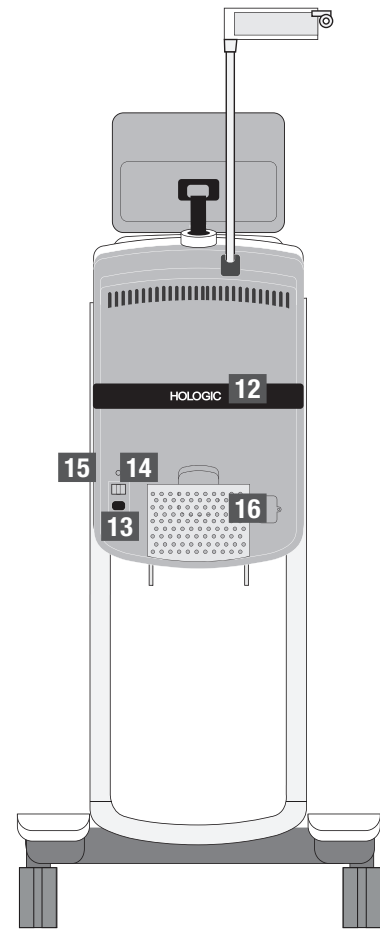

Figure 2: The rear of the Fluent Fluid Management System console

The shipping crate contains the Fluent Fluid Management System console and a separate shipping box containing the Fluent Fluid Management System components.

The following components are contained in the Fluent Fluid Management System shipping box:

- Touch Screen: Integrated User Interface for device control and operations support.
- Foot Pedal: Controls MyoSure Tissue Removal Device (TRD) operation
- Storage Basket: Container for lightweight items such as the Foot Pedal when not in use
- Power Cord: Establishes an electrical connection between the Fluent Fluid Management System and a wall outlet
- Fluent Fluid Management System Initial Setup Card: One sheet that shows how to unpack and set up the Fluent Fluid Management System
- Fluent Fluid Management System Operator's Manual: Document that describes how to use the Fluent Fluid Management System
- Fluent Fluid Management System User Reference Card: One sheet that highlights how to use the Fluent Fluid Management System

For a list of components not included, see Chapter 14: Disposables and Accessories

Fluid Bag

Fluid Bags (not included) hang on the IV Hooks at the top of the Fluent Fluid Management System. Hooks provide the ability to hang up to 6 liters of fluid containing hypotonic, isotonic, ionic and non-ionic distention fluids at once.

The Fluid Bag Tube connects to the blue Inflow Tube Set, which connects to the hysteroscope Inflow Channel Tube. Fluid is pulled from the Fluid Bag through the Inflow Tube Set and delivered through the hysteroscope Inflow Channel Tube into the patient's uterus.

WARNING!

Placing excessive force or weight on the IV Hooks can overload the scale connected to the IV Hooks. Doing so may result in an inaccurate fluid deficit value, causing risk to patient safety.

WARNING!

When performing monopolar hysteroscopic electrosurgery, the distension medium must be electrically non-conductive. Examples include glycine, sorbitol and mannitol. Isotonic irrigation fluids may only be used when performing bipolar electrosurgical resection procedures. Examples include saline and lactated Ringer's solution.

Touchscreen Monitor

The Touchscreen Monitor includes two system speakers and the Touchscreen User Interface. Tilt and swivel the monitor for optimal viewing.











Caution!









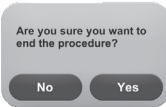

Only use the Handle to move or position the Fluent Fluid Management System. Do not pull or push the system by the Touchscreen Monitor.

Touchscreen User Interface

Use the Touchscreen User Interface to configure and view system information, set the deficit limit, prime the system, and make other adjustments as needed. The Touchscreen prompts performing a task (such as Hang Fluid Bag) and displays task status (such as Fluid Bag Hung).

Touchscreen Icons

Icon	Name	Description
	Help	Displays additional information
	System Settings	Displays the System Settings screen
	Clear	Clear
	Back	Clears an error condition
	Next	Displays the next step or screen
	Prime	Primes the system
	Confirm	Confirms the system request
	Pause	Pauses the procedure. When the system is paused, this button changes to Run to restart the procedure.
	Change	Displays the available settings for the selected item
	Down/Up	Decreases or increases the settings for the selected item
	Accept/Confirm	Applies the change to the selected setting

	Cancel/Decline	Cancels the change to the selected setting
	Run	Starts the pumps running to provide irrigation. When running, this button changes to Pause to halt the pumps.
	Complete Procedure	When ending a procedure, the Outflow pump continues to run to collect the remaining flow. Pressing this button stops the Outflow pump and displays the values for Total Deficit, Total Fluid Volume, Final Pressure, and Cutting Time.
	Exit	Returns to previous screen
	New Procedure	Displays the System Setup screen to start a new procedure
	Last Procedure	Displays results from the previous procedure
	End	Ends the procedure and begins evacuating the Out-FloPak tubing
	Zero	Resets the procedure's deficit value to zero
	Reprime	Primes the system again after a procedure has started
	Done	Ends evacuation of the Out-FloPak tubing

Fluent Procedure Kit

The Fluent Procedure Kit contains the Fluent In-FloPak, the Fluent Out-FloPak, the Waste Bag, and the Tissue Trap.

 **WARNING!** Do not reprocess or sterile disposable products

Reuse of Fluent In-FloPaks or Fluent Out-FloPaks can cause an infection hazard for patients and/or users as well as impair product functionality. Contamination and/or impaired functionality of the system can cause risk of injury, illness, or death. Do not re-process any of the components contained within the single-use Procedure Kit.

Fluent In-FloPak

The blue Fluent In-FloPak pulls clean fluid from the Fluid Bag.

The Fluent In-FloPak contains the Fluid Bag Tube and the hysteroscope Inflow Tube. It fits securely into the blue Fluent In-FloPak Receptacle on the front left side of the Fluid Management System.

Before each procedure, connect the tubes as follows:

- From the Fluid Bag Tube spike to the Fluid Bag
- From the hysteroscope Inflow Tube (that has a blue band adjacent to the Luer lock connector) to the Hysteroscope Inflow Channel

These connections allow the transfer of irrigation fluid from a Fluid Bag to the hysteroscope Inflow Channel. The flow of fluid is monitored and controlled using the Touchscreen to maintain the pressure at a specified setting.

Fluent Out-FloPak

The yellow Fluent Out-FloPak drains waste fluid from the hysteroscope Outflow Channel, the MyoSure Tissue Removal Device (TRD) Tube, and the Under Buttocks (UB) Drape Tube into the Waste Bag.

The Fluent Out-FloPak contains the Waste Bag Tube (which contains the in-line Tissue Trap), the hysteroscope Outflow Tube, the MyoSure Tissue Removal Device (TRD) Tube, and the Under Buttocks (UB) Drape Tube. It fits securely into the yellow Fluent Out-FloPak Receptacle on the front right side of the Fluid Management System.

Before each procedure, connect the tubes as follows:

- From the Waste Tube connector to the Waste Bag
- From the hysteroscope Outflow Tube (that has a yellow band adjacent to the Luer lock connector) to the Hysteroscope Outflow Channel

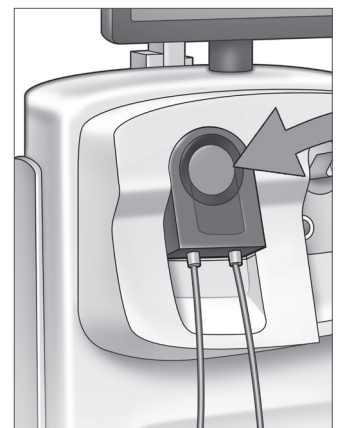

Fluent In-FloPak

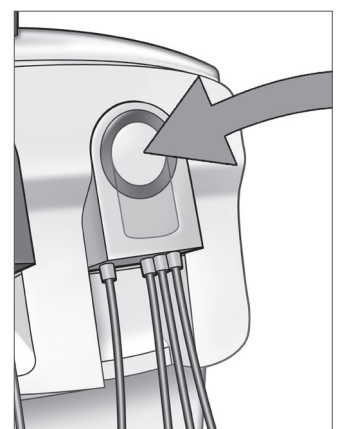

Fluent Out-FloPak

- Only when using MyoSure Tissue Removal Device (TRD) connect the tube that has a green band adjacent to the barb connector to the MyoSure Tissue Removal Device (TRD)
- From the Under Buttocks (UB) Drape Tube (that has a yellow suction connector) to the Under Buttocks (UB) Drape Port

These connections allow the transfer of fluid from the hysteroscope Outflow Channel, the MyoSure Tissue Removal Device (TRD), and the Under Buttocks (UB) Drape Port to the Waste Bag.

Waste Bag

The Waste Bag is designed to capture waste fluid from hysteroscopic procedures. The Waste Bag hangs on the Waste Bag Hanger at the bottom of the Fluent Fluid Management System. Hang only one Waste Bag at a time. The Waste Bag includes an attached cap. For details on replacing the Waste Bag, see Chapter 6: Replacing Components. If an accurate manual deficit assessment is required, pour fluid into calibrated container.

WARNING! The markings on the waste bag are not intended as a measuring device, only for general reference, not a specific volumetric measurement.

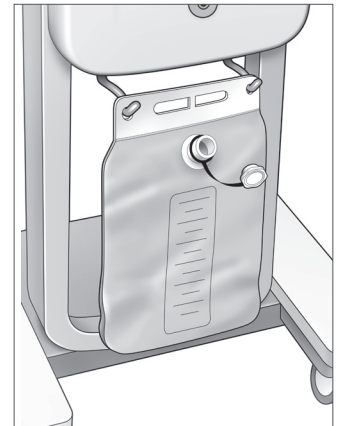

Waste Bag

Tissue Trap

The Waste Tube contains an in-line Tissue Trap designed to capture resected tissue throughout the procedure to allow the tissue to be sent to pathology for testing. The Tissue Trap Holder contains the Tissue Trap that captures the resected tissue. Please monitor the Tissue Trap so it does not overfill. For details on handling the Tissue Trap, see Chapter 7: Disassembly and Disposal.

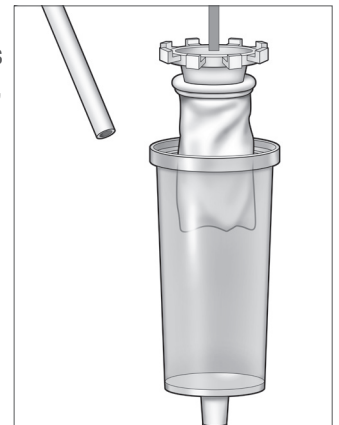

Tissue Trap

Controls and Functions

This section describes Fluent Fluid Management System controls and functions.

Wheels

The four wheels located on the bottom of the Fluent Fluid Management System enable movement and positioning of the Fluent Fluid Management System. For details on using the Wheel Locks, see Assembly Instructions provided in Chapter 3.

Contained in the Shipping Box

Foot Pedal

The Foot Pedal controls tissue removal device operation. It connects to the Foot Pedal Connector located on the Fluent Fluid Management System front panel.

Storage Basket

The Storage Basket hangs on the rear of the Fluent Fluid Management System. It is used to store lightweight items such as the Foot Pedal when not in use. Do not place heavy items in the Storage Basket. The maximum recommended weight is 10 pounds.

Power Cord

The Power Cord connects to Power Cord Connector located on the rear of the Fluent Fluid Management System. When the system is not in use, wrap the Power Cord around the Handle on the rear of the system.

Located on the Front of the Fluent Fluid Management System

MyoSure Tissue Removal Device (TRD) Connector

The MyoSure Tissue Removal Device (TRD) Connector is located on the Fluent Fluid Management System front panel above the Foot Pedal Connector. For details on operating the Tissue Removal Device, refer to MyoSure Tissue Removal Device Instructions For Use.

Foot Pedal Connector

The Foot Pedal Connector is located on the Fluent Fluid Management System front panel below the MyoSure Tissue Removal Device (TRD) Connector.

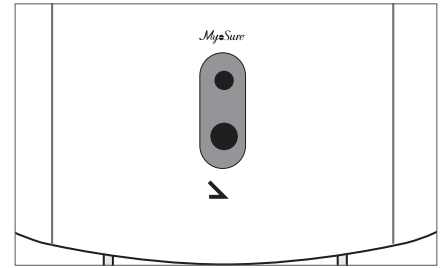

Foot Pedal Connector

Located on the Rear of the Fluent Fluid Management System

Handle

The Handle is located on the rear of the system.



Caution!

Only use the Handle to move or position the Fluent Fluid Management System. Do not pull or push the system by the IV Hooks or the Touchscreen Monitor.

On/Off Switch

The On/Off Switch is located on the rear of the Fluent Fluid Management System above the Power Cord Connector. The On/Off Switch is labeled with I for On and O for Off.

Power Cord Connector

The Power Cord Connector is located on the rear of the Fluent Fluid Management System below the On/Off Switch.

Equipotential Plug

The connector used to electrically bond the system to another conductive material, or ground the system to a safety ground.

After you have been introduced to the Fluent Fluid Management System components, you are ready to learn how to configure the Touchscreen settings. The next chapter describes configuring the Touchscreen settings.

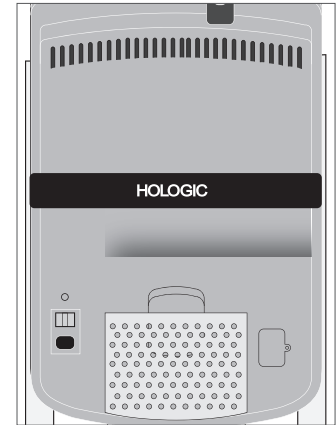

Rear of System

Chapter 2: Configuring the Touchscreen Settings

After you have been introduced to the Fluent Fluid Management System components, you are ready to configure the Touchscreen settings. This chapter describes how to configure the Touchscreen settings.

Turning on the Fluent Fluid Management System



WARNING! To avoid risk of electric shock, this equipment must only be connected to a supply mains with protective earth.



WARNING! Equipment should be positioned such that power cord can be easily disconnected.

To turn the system on, perform the following steps.

1. Connect the Power Cord to the rear of the Fluent Fluid Management System.
2. Plug the Power Cord directly into a wall outlet with the appropriate power for the Fluent Fluid Management System.
3. Press the top of the On/Off switch on the rear of the system to the On (I) position.
The system performs a setup routine and then displays the System Setup screen (Screen 1).

Note:

Touch the Help icon (?) at any time to display step-by-step instructions on the touchscreen.

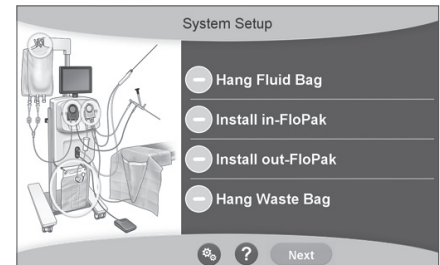

Screen 1: System Setup Screen

Configuring the Settings

When you first turn on the system, the System Setup screen is displayed.

To configure the system settings, touch the Settings icon (⚙️). The Settings screen is displayed as shown in Screen 2. Use the Settings screen to:

- Select the language to display
- Adjust the touchscreen brightness
- Adjust the speaker volume for alerts
- Display additional system information

To configure the settings, do any of the following:

- To configure the Language, touch the down arrow and select the language.
- To increase or decrease the Brightness, touch the plus sign or the minus sign.
- To increase or decrease the Volume, touch the plus sign or the minus sign.
- To view last procedure information, touch Last Procedure.

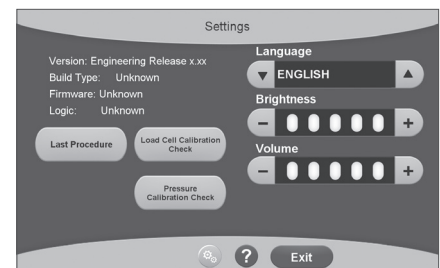

Screen 2: Settings Screen

After configuring the Touchscreen settings, you will want to connect the Fluent Fluid Management System components. The next chapter describes connecting the Fluent Fluid Management System components.

Chapter 3: Connecting the System Components

After you have configured the Touchscreen settings, you are ready to connect the Fluent Fluid Management System components. This chapter provides information and instructions for moving the system and connecting components.

Note:

For details on the setup and operation of the hysteroscope, refer to the hysteroscope's Instructions For Use.

Before Moving the Fluent Fluid Management System

Before moving the system from one location to another, make sure the system is in transport position:

- The Power Switch is in the Off (O) position
- The Power Cord is unplugged from the mains outlet and wrapped around the Handle on the rear of the system
- The Foot Pedal is disconnected from the front of the system and is located in the Storage Basket on rear of the system
- The wheels are in the unlocked position
- No fluid bags are attached to either the supply or waste hooks
- The rear basket contents weigh less than 10 lbs

Locking and Unlocking the Wheels

All wheels swivel to ease steering and positioning of the system, and have locks, as shown.

To lock the wheels:

Use your foot to touch down on the outer part of each wheel lock to secure the system from rolling, as shown.

To unlock the wheels:

Use your foot to touch against (inward) the upper part of each wheel lock.

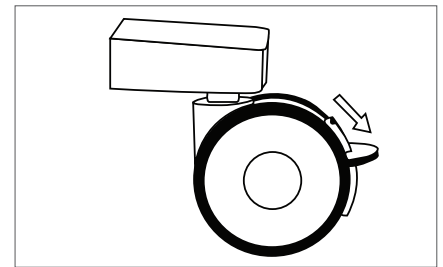

Wheel Lock

Using the Handle to Move the Fluent Fluid Management System

To move the Fluent Fluid Management System from one location to another, make sure to use only the Handle to push, pull, or steer the system.

WARNING!

Placing excessive force or weight on the IV Hooks can overload the scale connected to the IV Hooks. This can result in an inaccurate fluid deficit value, causing risk to patient safety.

Caution!

Do not lean on the Handle. Leaning may cause the system to tip.

Positioning the System

It is important to position the Fluent Fluid Management System a minimum of 5 ft (1.5 m) from the MyoSure Tissue Removal Device (TRD) to allow the Tissue Removal Device drive cable to hang in a large arc with no bends, loops, or kinks.

The ideal placement of the Fluent Fluid Management System is behind the Physician either to the right (if right-handed) or to the left (if left-handed).

Connecting the Components

Connecting the Power Cord

The Power Cord is connected to the rear of the system and wrapped around the Handle when not in use.

Connect the Power Cord directly into a wall outlet. Make sure the Fluent Fluid Management System is positioned in such a way that the Power Cord does not obstruct positioning or cause a tripping hazard.

WARNING!

Equipment should be positioned such that the Power Cord can be easily disconnected.

⚠ Caution!

Check to ensure the available wall outlet voltage matches the data listed on the label attached to the rear of the system. Incorrect voltage can cause errors and malfunctions and may destroy the system.

The power connection must be equipped with a grounding outlet. Use the Fluent Fluid Management System Power Cord to establish a connection between the wall outlet and the Power Port located on the rear of the Fluid Management System.

Note:

For more information about power cord safety, see Chapter 12: Technical Specifications.

Identifying Fluent Flo-Pak Tubes**Fluent In-FloPak Tubes**

The tubes of the blue Fluent In-FloPak connect to the following:

- The Fluid bag
- The Hysteroscope Inflow Channel

Fluent Out-FloPak Tubes

The tubes of the yellow Fluent Out-FloPak connect to the following:

- The Waste Bag
- The Under Buttocks (UB) Drape
- The Hysteroscope Outflow Channel
- Optional: The MyoSure Tissue Removal Device (TRD). Use only if performing MyoSure procedure.

System Setup

Perform the System Setup steps in the order that is most logical for your facility. Handle all materials according to your facility's protocol. Perform the following steps to prepare the Fluent Fluid Management System for use.

Hang the Fluid Bag**⚠ WARNING!**

The maximum amount of weight should not exceed 6L of fluid. Doing so may negatively impact fluid deficit accuracy.

1. Hang up to 6L of fluid from the IV Pole with distension media appropriate for the procedure. If you need to replace a Fluid Bag during the procedure, see the Chapter 6: Replacing Components.

Note:

The Fluent Fluid Management System does not need to be powered on to hang the Fluid Bags. If it is on, then follow the prompts. After the Fluid Bags have been hung properly, the system displays a green check mark.

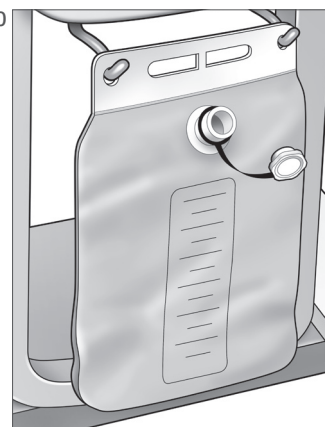

Waste Bag Hanger

Unpack the Fluent Procedure Kit

- 2a. Open the Fluent Procedure Kit package.
- 2b. Set the non-sterile Waste Bag aside.
- 2c. Peel back the sterile seal to open the Fluent In-FloPak and Fluent Out-FloPak and place them on a sterile surface.

Hang the Waste Bag**⚠ WARNING!**

The maximum amount of weight should not exceed one full Waste Bag (6kg). This can negatively impact fluid deficit accuracy.

3. Hang a new Waste Bag on the Waste Bag Hanger to begin any new procedure.

After the Waste Bag has been hung properly, the system displays a green check mark.

Connect the Blue Fluent In-FloPak

! WARNING! Original accessories

For your own safety and that of your patient, use only Fluent accessories.

- 4a. Snap the Fluent In-FloPak into place and wait for the green check mark before proceeding. Ensure Fluent In-FloPak is flushed with front of the console.
- 4b. Hang the Fluid Bag.
- 4c. Close both tubing clamps.
- 4d. Spike the Fluid Bag.
- 4e. Connect the hysteroscope Inflow Tube (that has a blue band adjacent to the Luer lock connector) to the hysteroscope Inflow Channel.
- 4f. Connect the light cord and the camera to the hysteroscope.

Note:

Do not unclamp the fluid bag tubes until prompted by system.

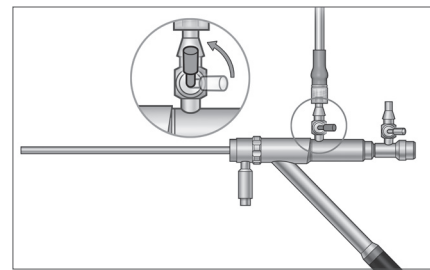

Hysteroscope Inflow Tube

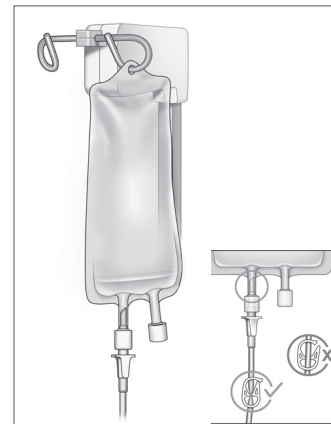

Close the tube clamp and spike.

Connect the Yellow Fluent Out-FloPak

! WARNING! Original Accessories

For your own safety and that of your patient, use only Fluent accessories.

- 5. Snap the Fluent Out-FloPak into place and wait for the green check mark before proceeding. Ensure Fluent Out-FloPak is flushed with front of the console.
- 6a. Connect the hysteroscope Outflow Tube (that has a yellow band adjacent to the Luer lock connector) to the hysteroscope Outflow Channel.
- 6b. Firmly press the Waste Tube Connector onto the Waste Bag opening.
- 6c. Connect the yellow suction connector onto the Under Buttocks (UB) Drape Port.
- 7. Touch 'Next' on the Touchscreen.

After you touch 'Next', the Fluent In-FloPak and Fluent Out-FloPak will lock into place. Unclamp Fluid Bag tube before priming. If you do this step before Step 7, fluid will leak out of the hysteroscope.

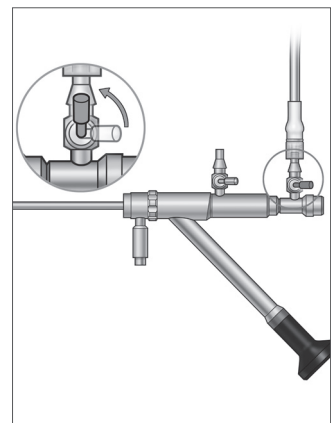

Hysteroscope Outflow Tube

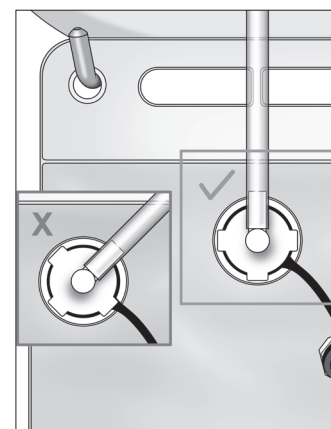

Waste Tube Connector

Connect the MyoSure Tissue Removal Device when required

Note:

MyoSure Tissue Removal Device setup may be performed at any stage of the procedure.

**WARNING! Original Accessories**

For your own safety and that of your patient, use only Fluent accessories. Tubing sets are single use disposables.

Following your facility's sterile protocol, perform the following steps:

- 1.** Connect the foot pedal.
- 2.** Connect the MyoSure drive cable to the connector on the front panel of the Fluent Fluid Management System.
- 3.** Connect the suction tube of the MyoSure Tissue Removal Device to the tube on the Out-FloPak that has a green band adjacent to the barb connector.

After connecting the Fluent Fluid Management System components, you are ready to prime the system as per Chapter 4: Priming the System.

This page is intentionally left blank



During Procedure

Chapter 4: Priming the System

After you have connected all the Fluent Fluid Management System components, you are ready to prime the system.

This chapter provides instructions for priming the system.

Touching the Prime icon causes the following events to occur:

- Outflow and Inflow pumps turn on
- Pressure default value is set to 80 mmHg
- Deficit limit default is set to 800 mL
- Fluid is drawn from the Fluid Bag through the tubing and out the hysteroscope (which is aimed at the Under Buttocks (UB) Drape) and collected into the Waste Bag.

Priming the Fluent Fluid Management System

Begin each procedure with a new, full Fluid Bag. Priming the system runs the pump for approximately 1 minute to purge air from the tubing and determine the flow resistance of the hysteroscope. Once Priming has begun, do not adjust Fluid or Waste Bag. Allow System to complete prime prior to adjusting Fluid or Waste Bag. Failure to do so may result in inaccurate deficit readings or final procedure results. If this occurs, the deficit or final procedure results will need to be calculated manually.

Before Priming: Make sure that the Fluent In-FloPak and Fluent Out-FloPak are properly connected as described in Chapter 3: Connecting the System Components.

When to Prime: Prime the system at the beginning of a case, and again if you change hysteroscopes.

How to Prime: To prime the system, perform the following steps:

1. Confirm the Fluid Bag clamp is open.
2. Make sure that the blue hysteroscope Inflow Channel is open.
3. Aim the hysteroscope into the Under Buttocks (UB) Drape at the patient height.

WARNING!

Do not prime inside the patient.

4. Touch 'Prime' on the Touchscreen.

To stop priming at any time, touch 'Pause'.

When priming is resumed after pausing, the system will restart the priming sequence from the beginning.

5. When the Prime Complete screen displays, Touch 'Next' on the Touchscreen. System does not need to be zeroed after priming if priming was done inside the under-buttocks drape. If priming was done outside of the under-buttocks drape the fluid deficit needs to be zeroed as a false deficit can ensue.

After successfully priming the Fluent Fluid Management System, it is ready to operate during a procedure. The next chapter provides instructions for operating the Fluent Fluid Management System.

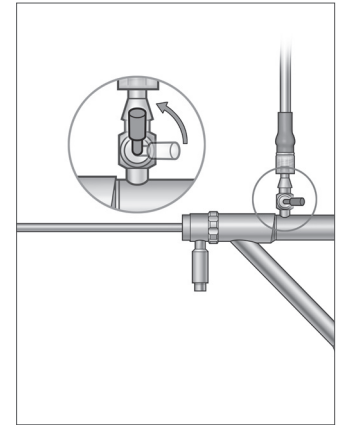

Open Inflow Channel

Chapter 5: Operating the System

After you have primed the Fluent Fluid Management System, you are ready to operate the system.

This chapter provides information and instructions for operating the Fluent Fluid Management System with the MyoSure Hysteroscope and MyoSure Tissue Removal Device (TRD). For complete instructions on the use and operation of the Hysteroscope and the TRD, including warnings and cautions, refer to the documentation for those devices.

Adjusting the Intrauterine Pressure

This section describes how to adjust the intrauterine pressure. The pressure can be adjusted from 40 mmHg to 120 mmHg.

WARNING!

The uterine cavity distention pressure should be the lowest pressure necessary to distend the uterine cavity and ideally should be maintained below the mean arterial pressure (MAP).

To adjust the pressure:

1. Touch the 'Change' button in the Pressure circle.
2. Touch the Down or Up controls to change the Pressure setting.
3. Touch the Accept icon () to confirm.

WARNING!

If the deficit is rapidly increasing, or the visualization field does not respond to a change in pressure set point, this may indicate that the uterus has been perforated or that fluid is escaping elsewhere. Examine the visual field for injury or a leak from the cervix.

Adjusting the Deficit Limit

The deficit is the total amount of fluid left in the patient, remaining in In-FloPak and Out-FloPak, or unaccounted for otherwise.

About Deficit Limits

- The default Deficit Limit is set to 800 mL
- The Deficit Limit can be adjusted from 100 mL to 2500 mL in increments of 50 mL.

Note:

Deficit reported is the total fluid volume that has left the fluid bags and has not returned to the waste bag. This may include fluid remaining in In-FloPak and Out-FloPak

Perform the following steps to adjust the Deficit Limit as necessary.

1. Touch the 'Change' button in the Deficit Limit circle.
2. Touch the Down or Up controls to change the Deficit Limit or select the setting.
3. Touch the () to confirm.

Starting the Hysteroscopy

Touch 'Run' to start the Hysteroscopy and wait 3 seconds for system to stabilize.

Using the MyoSure Tissue Removal Device (TRD)

After pressing the 'Run' button to start the procedure, the foot pedal can be used to operate the MyoSure Tissue Removal Device. The MyoSure Tissue Removal Device cannot be operated when the Fluent Fluid Management System is paused. Refer to the MyoSure Tissue Removal Device Instructions for Use for more information on how to use the MyoSure Tissue Removal Device.

System Recovery

If at any point during a procedure, (i.e. after a power failure) the System Recovery screen is displayed, touching 'Recover' will recover procedure data, including deficit data, to resume current procedure. If resuming a current procedure is desired, touching 'Recover' is recommended. Starting a new procedure will lose all previous procedure data. If a new procedure is started unintentionally, the deficit will need to be calculated manually.

Replacing Items during a Procedure

The Fluent Fluid Management System allows you to replace the following components during a procedure.

- The Fluid Bag
- The Waste Bag

- The Tissue Trap

For instructions on replacing these components, see Chapter 6: Replacing Components.

Changing Hysteroscope during a Procedure

The Fluent Fluid Management System allows you to change hysteroscope during a procedure. Changing the scope may prompt the user to Reprime. For complete instructions on the use and operation of the hysteroscope, including warnings and cautions, refer to the documentation for the devices.



Caution!

Failure to reprime after changing hysteroscope may affect uterine pressure control.

The system may only be connected with hysteroscope designed for and featuring the technical specification permitting such a combined use. Any utilized hysteroscope must comply with the most recent versions of EC 60601-2-18 and ISO 8600.

Note:

Before beginning reprime, ensure Fluid Bag has enough fluid to complete the reprime process. If there is not enough fluid, replace Fluid Bag with a new, full Fluid Bag. Once repriming has begun, do not adjust Fluid or Waste Bag. Allow System to complete reprime prior to adjusting Fluid or Waste Bag. Failure to do so may result in inaccurate deficit readings or final procedure results. If this occurs, the deficit or final procedure results will need to be calculated manually.

Completing the Procedure

Perform the following steps to end the procedure:

1. When the procedure is complete, touch the 'End' button.
2. The system displays a message confirming that you want to end the procedure.
3. To end the procedure, touch 'Yes'. To continue the procedure, touch 'No'.

Note:

Do not remove the Fluent Out-FloPak if you want to allow suction to continue to run to remove excess fluid from the Under Buttocks (UB) Drape to accurately reflect the deficit. The Fluent Out-FloPak will continue to evacuate fluid to ensure accurate deficit value and all resected tissue is captured.

Do not remove Fluid Bag and Waste Bag at this time. Allow the system to remove excess fluid to accurately reflect the deficit. If the Fluid Bag or Waste Bag are removed at this time, the deficit will need to be calculated manually.

4. When you feel the excess fluid has been removed from the Under Buttocks (UB) Drape, touch 'Done'.
5. The system displays a message, 'OK to remove Disposables.'
6. Clamp the Fluent in-FloPak tubes.
7. The Summary Screen displays the following final procedure results:
 - Total Deficit
 - Total Fluid Volume Collected
 - Final Pressure
 - Cutting Time
8. Disconnect outflow tubing from Waste Bag.
9. Remove the Tissue Trap from the Tissue Trap Holder to access resected tissue.
10. Screw on the cap and remove Waste Bag.
11. Disconnect tube sets from the hysteroscope.
12. Dispose of FloPaks and Waste Bag.
13. Turn off system and unplug cord from outlet.
14. Remove the In-FloPak and Out-FloPak and discard it.

Note:

If you forget to record the results, the Fluent Fluid Management System retains the results from the last procedure. To view the results prior to starting a new procedure, perform the following steps:

1. On the System Setup Screen, touch the Settings icon (⚙️).
2. On the Settings screen, touch '**Last Procedure**'.

After operating the Fluent Fluid Management System, you will want to disassemble and dispose of materials that you used during the procedure. Chapter 7 provides instructions for disassembly and disposal.

Chapter 6: Replacing Components

This chapter provides information and instructions for replacing Fluent Fluid Management System Fluid Bags, Waste Bags, and Tissue Traps.

Depending on the procedure, you may need to replace disposable components. To alert you of changes, the Fluent Fluid Management System IV Pole and Waste Bag built-in scales prompt you if you need to take action. Changing waste bag without pausing the system may lead to inaccurate deficit values.

Note:

Prior to replacing any System Component, ensure any error messages are resolved first. Failure to do so may result in inaccurate deficit readings or final procedure results.

If Fluid or Waste Bag are not changed in accordance with the instructions below, the deficit and/or final procedure results may need to be calculated manually.

Replacing the Fluid Bag

Add a new Fluid Bag when the system alerts you the supply bag is low.

Perform the following steps to replace the Fluid Bag during a procedure:

1. Hang bag on either hook (**do not remove empty bag, doing so may result in inaccurate final procedure results, such as total fluid volume collected.**)
2. 1-3 Liter bag may be used.
3. Maximum weight on hook = 6 Liters of fluid.
4. Insert spike into bag port.
5. If using two bags, only spike one at a time.
6. Open clamp on the spiked bag before resuming procedure.

Replacing the Waste Bag

Replace the Waste Bag when the system alerts you.

Perform the following steps to replace the Waste Bag during a procedure:

1. Touch 'Pause' to pause the system. (**Not touching 'Pause' may result in inaccurate deficit readings.**)
2. Remove outflow tubing from Waste Bag.
3. Screw cap into Waste Bag Opening.
4. Remove from hooks and discard according to facility protocols.
5. Hang bag by placing both outer rings on both hooks.
6. Bag should sit clearly in hook notches.
7. Make sure Waste Bag cap is not closed.
8. Attach outflow tubing from yellow out-FloPak onto Waste Bag opening.
9. If 'Missing Waste Bag' error is displayed, make sure Waste Bag is in valley of the hooks, touch 'Clear' and continue with the procedure.

Replacing the Tissue Trap

Perform the following steps to replace the Tissue Trap during a procedure.

1. Touch 'Pause' to pause the system.
2. Open Tissue Trap Holder lid.
3. Remove Tissue Trap and place into pathology container.
4. Place new Tissue Trap into the Tissue Trap Holder.
5. Close the Tissue Trap Holder lid securely.
6. Make sure Waste Bag cap is still attached to Waste Bag.

This page is intentionally left blank



After Procedure

Chapter 7: Disassembly and Disposal

After completing the procedure with the Fluent Fluid Management System, you are ready to disassemble and dispose of materials that you used during the procedure. This chapter provides information and instructions for disconnecting the Fluent Procedure Kits and other components from the Fluent Fluid Management System, and information for disposing of components.



WARNING! Reprocessing of sterile disposable products

Reuse of Fluent In-FloPaks or Fluent Out-FloPaks can cause an infection hazard for patients and/or users as well as impair product functionality. Contamination and/or impaired functionality of the system can cause risk of injury, illness, or death. Do not re-process single-use Fluent In-FloPaks or Fluent Out-FloPaks.

Note:

Comply with your facility's hygiene rules when disposing of Fluent Procedure Kits, the Tissue Trap, fluid collected, and the Waste Bag.

Disassembly and Disposal

1. Remove the MyoSure Tissue Removal Device (TRD) and hysteroscope from the patient.
2. Perform the following steps:
 1. Disassemble the MyoSure Tissue Removal Device (TRD)
 - a. Remove the TRD from the hysteroscope.
 - b. Disconnect the outflow TRD Tube from the TRD.
 - c. Disconnect the TRD from the Fluent Fluid Management System console.
 - d. Dispose of the TRD according to your facility's protocol.
 2. Collect Pathology
 - a. Locate a pathology container (not supplied).
 - b. Pull the waste bag connector from the Waste Bag to detach.
 - c. Open the Tissue Trap Holder lid.
 - d. Remove the Tissue Trap and place it into the pathology container.
 - e. If additional tissue is to be collected, place a new Tissue Trap into the Tissue Trap Holder. Close the Tissue Trap Holder lid securely and attach the Waste Tube Connector to the Waste Bag.
 3. Dispose of Waste Materials
 - a. Screw on the attached Waste Bag Cap and remove the Waste Bag.
 - b. Discard the Waste Bag according to your facility's protocol.
 4. Disassemble the Under Buttocks (UB) Drape
 - a. Remove the Under Buttocks (UB) Drape Tube from the Under Buttocks (UB) Drape Port.
 - b. Dispose of the Under Buttocks (UB) Drape according to your facility's protocol.
 5. Disassemble the Hysteroscope
 - a. Clamp the hysteroscope Inflow Tube.
 - b. Remove the hysteroscope Inflow Tube.
 - c. Remove the hysteroscope Outflow Tube.
 6. Disassemble the Fluent In-FloPak
 - a. Clamp the Fluid Bag Tube.
 - b. Remove the spike from the Fluid Bag.
 - c. Remove the Fluent In-FloPak from the Fluent In-FloPak Receptacle on the front left side of the Fluent Fluid Management System console.
 - d. Dispose of the Fluent Out-FloPak according to your facility's protocol.

7. Disassemble the Fluent Out-FloPak

- a.** Remove the Fluent Out-FloPak from the Fluent Out-FloPak Receptacle on the front right side of the Fluent Fluid Management System console.
- b.** Dispose of the Fluent Out-FloPak according to your facility's protocol.

8. Disassemble the Fluent Fluid Management System

- a.** Touch the On/Off switch to the Off (O) position.
- b.** Unplug the Foot Pedal and store the Foot Pedal in the Storage Basket.
- c.** Unplug the Fluent Fluid Management System console Power Cord.
- d.** Wrap the Power Cord around the Handle on the back of the system.
- e.** Disinfect the Fluent Fluid Management System surface according to your facility's protocol.

After disassembling and disposing of materials that you used during the procedure, you will want to clean the Fluent Fluid Management System and store it for future use. The next chapter provides instructions for maintaining the system.

Chapter 8: Maintenance

After disassembling and disposing of materials that you used during the procedure, you are ready to maintain the Fluent Fluid Management System by shutting it down and storing it until the next procedure. This chapter provides information and instructions for maintaining the Fluent Fluid Management System. No other serviceable components.

Storing the System

After the procedure is completed, perform the following steps to shut down the system and store it until the next procedure:

1. Make sure the power switch on the rear of the Fluent Fluid Management System is in the Off (O) position.
2. Disconnect the Power Cord from the power outlet.
3. Wrap the Power Cord around the Handle on the rear of the Fluent Fluid Management System.
4. Disconnect the Foot Pedal from the front of the Fluent Fluid Management System and store it in the Storage Basket.
5. Clean the Fluent Fluid Management System in preparation for its next procedure.

Note:

To prolong the life of the Fluent Fluid Management System, do not hang any items from the IV Pole while storing the system.

Cleaning the Fluent Fluid Management System

1. Disconnect the Fluent Fluid Management System from the electrical source
2. Wipe the System with a clean damp cloth and mild germicide or isopropyl alcohol

Wiping the System Down

Wipe the surface of the system with a soft cloth moistened with a disinfectant (for example, 5% dishwashing soap in water or PDI Sani-Cloth AF3 or PDI Sani-Cloth HB or 70% isopropyl alcohol or 10% bleach solution). The concentration of the used disinfectant depends on the information provided by the manufacturer of the disinfectant. Make sure moisture does not enter the system.

Note:

- a) 10% chlorine bleach and water solution (consisting of one part commercially available bleach and nine parts water)
- b) Commercially available isopropyl alcohol solution (typically 70% isopropyl alcohol by volume, undiluted)



Caution!

Do not sterilize or immerse the Fluent Fluid Management System in disinfectant.

Replacing the Fuse

If the system does not function, the fuse may be defective and need to be replaced.

The fuse holder is located in the power module on the rear of the system. The fuse type is T5AH, 250 V fuses. There are 2 per system.

Before replacing the fuse, check the following:

- The Power Cord is properly connected to both the Power Port on the rear of the Fluent Fluid Management System and to a grounded safety wall outlet.
- The wall outlet has power. Test the outlet by plugging in another device to ensure it is working properly.

To replace the fuse:



WARNING!

Unplug the Power Cord from the wall outlet and from the system before checking the fuse.



Caution!

Before replacing the fuse, check that the new fuse type matches the fuse specified in the Technical Specifications chapter.

1. Turn the system off (O).
2. Disconnect the power cord from the wall outlet.
3. Using a small flathead screwdriver, remove the fuse holder.

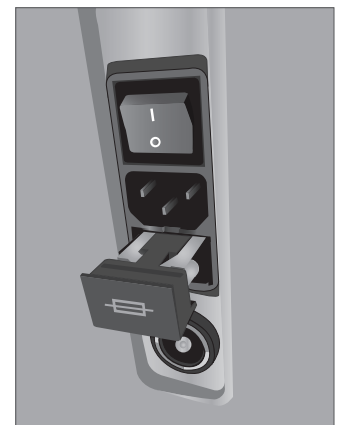

Fuse Location

4. Pull out the fuse holder and check the fuse.
5. Insert the new fuse. Use only the type of fuse: T5AH, 250 V fuses.
6. Insert the fuse holder.
7. Reconnect the Power Cord to the wall outlet and turn the system On (I) to ensure it is working properly.

Load Cell Calibration Check

The fluid deficit measurement test checks the fluid bag load cell and the waste bag load cell and the accurate measurement of weight to ensure that all elements are functioning properly. This test requires a 500 gram weight which is shipped with the system.

1. Turn the system ON.
2. Touch button (ⓘ) for settings screen
3. Hang 500 gram weight on one of the fluid bag hooks
4. Touch the button for 'Load Cell Calibration Check'
5. Number displayed for the 'Supply Weight' should be $500 \pm 25\text{g}$
6. Remove weight from the fluid bag hook and hang the 500 gram weight on one of the waste bag hooks
7. Number displayed for 'Collection Weight' should be $500 \pm 25\text{g}$
8. Remove weight from the waste bag hook
9. Select 'Exit' to return to the setup screen.

Pressure Calibration Check

The pressure measuring test checks the pressure accuracy to ensure that all elements are functioning properly. This test requires an in-FloPak, 3000mL fluid bag and an under buttocks drape or bucket. The fluid bag is placed on the supply load cell hanger to produce the hydrostatic pressure that is used to test the pressure sensor.

1. Turn the system ON.
2. Place the in-FloPak onto the console.
3. Touch (ⓘ) button for settings screen
4. Choose 'Pressure calibration check'
5. Choose 'Lock'
6. Hang the 3000mL of fluid bag on one fluid bag hook. Make sure that bag clamp is pinched. (Fluid will spill out if not done)
7. Fully pinch both inflow clamps
8. Remove bag spike cap and spike bag with one inflow spike, leave other spike capped.
9. Place a bucket onto the ground and place the Hysteroscope Inflow Channel Luer lock into the bucket.
10. Open clamp connected to full bag
11. Open clamp connected to the in-FloPak
12. Open clamp connected to the Hysteroscope Inflow Channel Luer Lock
13. Touch 'Start' to fill tube with fluid. When tube is filled and air bubbles in line are gone, touch 'Stop'.
14. Remove the Luer Lock from the bucket and hold it even with top of fluid bag hanger.
15. Apply firm, even pressure on the In-FloPak to ensure it is seated properly.
16. Number displayed for pressure reading should be $20 \pm 5 \text{ inH}_2\text{O}$.
17. Place the Luer Lock back into the bucket.
18. Select 'Exit' to return to the setup screen.
19. Pinch fluid bag clamp.
20. Remove bag spike from the fluid bag. Then remove cartridge from the console to allow fluid to drain into the bucket.

Chapter 9: Notifications and Messages

The Fluent Fluid Management System Touchscreen Monitor provides help for troubleshooting notifications and messages. To display help for a component, touch the component within its yellow circle on the Touchscreen Monitor.

Help During Setup

- To display help at any time, touch the Help icon (?).
- Alternatively, if you touch a component within its yellow circle, a help screen for that component appears.
- Follow the on-screen prompts.
- During setup, help for the following procedures is available:
 - Hang Fluid Bag
 - Install In-FloPak
 - Install Out-FloPak
 - Hang Waste Bag

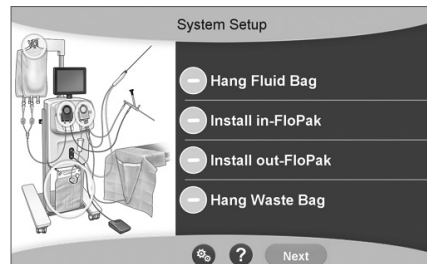

Help during Setup

Help During a Procedure

- To display help at any time, touch the Help icon (?).
- Follow the on-screen prompts.
- During a procedure, help for the following components is available:
 - Fluid Bag
 - Inflow and In-FloPak
 - Outflow and Tissue Trap
 - Waste Bag
 - Hysteroscope
 - MyoSure Tissue Removal Device



Troubleshooting

Chapter 10: Troubleshooting

This chapter describes problems that you might encounter while using the Fluent Fluid Management System and how to solve them. For help with errors not listed in this chapter, please follow the on-screen prompts.

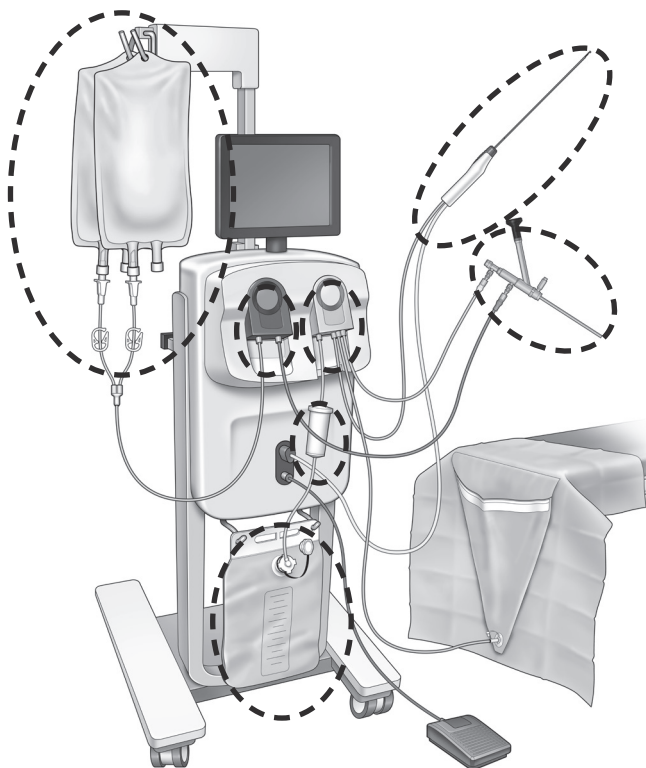

During Setup

- If the In-FloPak is not detected, apply firm, even pressure on the In-FloPak to ensure it is seated properly and press 'Next'.
- If the Waste Bag is not detected, ensure tube connection is oriented vertically.

Loss of Suction

- Ensure the hysteroscope outflow tubing is connected to the hysteroscope.
- Ensure the buttocks drape tubing is connected to the buttocks drape.
- Ensure the outflow tubing is connected to the outflow port.

Visibility Issues

- Verify that the fluid bag clamp is open.
- To provide a tamponade effect, intrauterine pressure may need to be adjusted during the procedure.
- If performing a MyoSure procedure, advance the MyoSure Tissue Removal Device to the fundus and allow circulation of fluid through the blade to clear field.
- Ensure the out-flow stop cock is fully open.

Poor Uterine Distension

- Avoid over dilation of the cervix. If the cervix is over dilated, use a second tenaculum to seal the cervix.
- Verify the fluid bag clamp is open.
- Ensure the pressure setting is adequate.
- Ensure the inflow tubing is not occluded or pinched.

Cutting Issues

- Ensure the MyoSure Tissue Removal Device is fully inserted into the Fluent Fluid Management System.

- Orient the MyoSure Tissue Removal Device cutting window against the tissue when the foot pedal is activated. If you see flashing from the scope, it means the window is not directly over the tissue.
- Ensure the outflow tubing is not occluded or pinched.
- Avoid bending the MyoSure tissue removal device handle.

Fluent Fluid Management System

- If the Fluent Fluid Management System powers down unexpectedly, leave it off for 15 seconds, restart the system and follow on-screen prompts.

Display Error and Troubleshooting

Warning Text	Warning Code	Description	Resolution
Supply bag low -	01010033	Bag contains less than 500ml	Add and spike another Fluid bag
Waste bag almost full -	01010034	WB will be full in 500ml	Replace waste bag
Approaching Deficit Limit -	01010037	Deficit is within 75% of set limit	Readjust Deficit Limit if appropriate.
Warning - High Pressure -	010A0004	Any momentary high pressure condition that lasts more that 2s but less than 5s	Ensure that line between in-FloPak and scope inflow is open. Ensure scope tip is not up against uterine fundus.
Reprime required -	010A0008	Unexpected difference between measured and predicted uterine pressure	During priming, the scope must be open to the air at the level of the patient. Ensure that the fluid flow at the end of the scope is not blocked. Scope must not be in the uterus when priming. Ensure that inflow tube clamp and scope stopcock are open to allow fluid to flow freely. Once checked per above steps - Reprime the scope.
MyoSure device not found -	01070001	Device is not fully plugged in or defective	Ensure device is properly plugged in. If problem persists use another MyoSure device.
MyoSure motor stalled -	01070009	Excessive force or bend is being applied to the device	Reduce bending force on MyoSure device, then release and depress foot pedal to resume cutting. If problem persists, use another MyoSure device.
in-FloPak locking error -	01040004	In-FloPak failed to properly lock into the console, or is not fully seated	Make sure the In-FloPak is fully seated into the console. You may need to hold it down during the locking sequence.
Pump is moving when calibration pressure is requested -	01040008	Pump is on during pressure calibration check	Exit calibration check and run the calibration check again.

Warning Text	Warning Code	Description	Resolution
Out-FloPak locking error -	01050004	Out-FloPak failed to properly lock into the console, or is not fully seated	Make sure the Out-FloPak is fully seated into the console. You may need to hold it down during the locking sequence.
MS motor sensor fault -	01070002	MyoSure motor error	Reduce bending force on MyoSure device, then release and depress foot pedal to resume cutting. If problem persists, use another MyoSure device.
MS Motor Temp Too High -	01070003	MyoSure motor error	Release and depress foot pedal to restart.
Pressure limited by scope size being used -	010A000B	The set pressure is greater than the system will allow with the scope being used.	If clinically safe, use a larger diameter scope. Check if the inflow stopcock is partially closed or blocked during priming. If so, reprime the scope.
Flow limited by scope size being used -	010A000C	The flow rate is limited by the scope being used.	If clinically safe, use a larger diameter scope. Check the inflow stopcock is partially closed or blocked during priming. If so, reprime the scope.

Error Text	Error Code	Description	Resolution
Supply empty, clamped or not spiked -	020A0006	The pump fluid used is greater than the load cell fluid used.	Ensure that supply line is open and that the bag contains fluid.
Supply bag missing -	02010023	Supply bag is missing or empty.	Hang another supply bag.
Waste bag missing -	02010024	Waste bag is not correctly hung or is missing	Ensure waste bag is correctly hung from both waste hooks.
Waste bag full -	02010025	Waste bag is at full capacity.	Replace the waste bag with a new waste bag.
Check fluid bag hooks -	02010026	Check if the hooks were handled, or if a supply bag has been excessively jostled. This may also occur when excessive force is momentary imparted on the hooks during a bag change or when moving the console.	Keep hands off of supply hooks. Remove any object other than bags from hooks. If bag is moving, stabilize it, wait a few seconds and touch 'Clear'

Error Text	Error Code	Description	Resolution
Check waste bag hooks-	02010027	Check if the hooks were handled, or if the waste bag has been excessively jostled. This may also occur when excessive force is momentary imparted on the hooks during a bag change or when moving the console.	Keep hands off of waste hooks. Remove any object other than the bag from hooks. If bag is moving, stabilize it, wait a few seconds and touch 'Clear'
Deficit limit exceeded -	02010028	Deficit limit exceeded	End the procedure. If the doctor determines that it is clinically safe, increase the deficit limit, touch Clear, and resume running the procedure.
Pressure too high -	020A0005	Measured uterine pressure is greater than 165 mmHg for over 5s. End of scope may be up against uterine fundus.	Ensure scope is clean and tip is not blocked. Ensure the inflow stopcock and outflow stopcock are both open.
Priming error, ensure scope end not blocked -	020A0007	The system has detected pressure buildup during priming.	During priming, the scope must be open to the air at the level of the patient. Ensure that the fluid flow at the end of the scope is not blocked. Scope must not be in the uterus when priming. Ensure that inflow tube clamp and scope stopcock are open to allow fluid to flow freely. All scopes must be primed prior to use. To continue procedure, exit this screen: 1. Touch 'Clear' 2. Remove scope from uterus 3. Reprime the scope before continuing the procedure.

Runtime and System Fault Text	Runtime and System Fault Code	Description	Resolution
Supply bag overweight -	04010020	There is more 15kg of weight on the supply bag hook.	Remove all weight from supply hooks and reboot the system
Waste bag overweight -	02010021	There is more 15kg of weight on the waste bag hook.	Remove all weight from waste hooks and reboot the system
Various Text -	04XXXXXX	Various Runtime Faults	Turn power off, and then on. If problem persists, contact Hologic.
Various Text -	08XXXXXX	System Fault	Turn off system and contact Hologic.



Supplementary Information

Chapter 11: Annual Inspection and Testing

This chapter provides information about the annual inspection, and information and instructions for performing the safety tests.

Annual Inspection

The Manufacturer stipulates that these tests are performed annually to assess its functionality and technical safety. These inspections must be carried out annually. Regular inspections will assist in early detection of possible malfunctions. This helps maintain the system and increases its safety and service life.



WARNING!

If the specified parameters and tolerances are exceeded, the system must be returned to Hologic for evaluation.

Load Cell Calibration Check

The fluid deficit measurement test checks the fluid bag load cell and the waste bag load cell and the accurate measurement of weight pressure (and differential) to ensure that all elements are functioning properly. This test requires a 500 gram weight.

1. Turn the system ON.
2. Touch button (ⓘ) for settings screen
3. Hang 500 gram weight on one of the fluid bag hooks
4. Touch the button for 'Load Cell Calibration Check'
5. Number displayed for the 'Supply Weight' should be $500 \pm 25g$
6. Remove weight from the fluid bag hook and hang the 500 gram weight on one of the waste bag hooks
7. Number displayed for 'Collection Weight' should be $500 \pm 25g$
8. Remove weight from the waste bag hook
9. Select 'Exit' to return to the settings screen, then select 'Exit' to return to the setup screen.

Pressure Calibration Check

The pressure measuring test checks the pressure chamber, pressure sensor and the accurate measurement of pressure to ensure that all elements are functioning properly. This test requires an in-FloPak and 3000mL fluid bag and an under buttocks drape or bucket. The fluid bag is placed on the supply load cell hanger to produce the hydrostatic pressure that is used to test the pressure sensor.

1. Turn the system ON.
2. Place the in-FloPak onto the console.
3. Touch (ⓘ) button for settings screen
4. Choose 'Pressure calibration check'
5. Choose 'Lock'
6. Hang the 3000mL of fluid bag on one fluid bag hook. Make sure that bag clamp is pinched. (Fluid will spill out if not done)
7. Fully pinch both inflow clamps
8. Remove bag spike cap and spike bag with one inflow spike, leave other spike capped.
9. Place a bucket onto the ground and place the Hysteroscope Inflow Channel Luer lock into the bucket.
10. Open clamp connected to full bag
11. Open clamp connected to the in-FloPak
12. Open clamp connected to the Hysteroscope Inflow Channel Luer Lock
13. Touch 'Start' to fill tube with fluid. When tube is filled and air bubbles in line are gone, touch 'Stop'.
14. Remove the Luer Lock from the bucket and hold it even with the tip of the fluid bag bracket.
15. Number displayed for pressure reading should be 20 ± 5 inH2O.
16. Place the Luer Lock back into the bucket.
17. Select 'Exit' to return to the settings screen, then select 'Exit' to return to the setup screen.
18. Pinch fluid bag clamp.
19. Remove bag spike from the fluid bag. Then remove cartridge from the console to allow fluid to drain into the bucket.

Chapter 12: Technical Specifications

This chapter lists the technical specifications for the Fluent Fluid Management System and information about power cord safety.

Technical Specifications

Table 1 Fluent Fluid Management System Technical Specifications

Item	Specification
Model or type designation	FLT-100
Mains voltage range [V]	100-240 VAC
Supply Frequency Range [Hz]	50-60Hz
Fuse designation	T5AH, 250 V fuses
Mode of Operation	Continuous
Power Consumption	350W
Upper Voltage Range	
Normal Operation	240 VAC
Peak	264 VAC
Lower Voltage Range	
Normal Operation	120 VAC
Peak	90 VAC
Protection class (I, II, III)	I
Application part type (B, BF, CF)	BF
Defibrillator protected (yes, no)	No
Protection type (IP code)	IP21
Classification (I, IIa, IIb, III acc. To Appendix IX of European MDD)	IIb
Conformity with the following standards	IEC 60601-1:2005 + A1:2012 IEC 60601-1-6 IEC 62366-1:2015Ed.1 IEC 62304:2006 Ed.1 +A1 IEC 60601-1-2:2014
Operating conditions	15-30°C / 58-85°F 20-80% rel. humidity, Non-Condensing 8000 ft (2438.4 Meters) max. altitude above sea level for use
Use possible with flammable anesthetic gases	No
Storage and transportation conditions	-10-60°C / 14-140°F 10-80% rel. humidity, Non Condensing
Maximum sound level	≤75 decibels (dBa at 1meter)
Adjustable Values	
Pressure range (mmHg)	40 - 120
Deficit Limit (mL)	100 - 2500
Measurement range	
Flow (mL/min)	0-650
Deficit (mL)	-9999 / +99999
Accuracy	
Pressure (mmHg)	± 15
Flow (mL/min)	± 50
Deficit (mL)	± 50 under normal use

Item	Specification
Dimensions (Width x Height x Depth)	25in x 60in x 25in / 250mm x 600 x 250mm
Weight	Unpacked console 40kg
Mass	40Kg
Safe Working Mass	44.5Kg
Interfaces	
Signal IN/OUT components	None
Mains connection	IEC-60320-1 C14
Maximum Load Cell Capacity	<6.3Kg for Supply and Waste bag hooks
System Useful Life	The system shall have a useful life up to 1,000 hr

Power Cord Safety

Ensure the connection data and technical specifications of the power supply comply with DIN VDE or national requirements. The wall outlet power supply cord must be plugged into a properly installed safety wall plug (see DIN VDE 0107). Read the device label located in rear of pump to determine the operating voltage of the system.

The power connection must be equipped with a grounding contact. Use the Fluent Fluid Management System power cord to establish a connection between the wall outlet and the power cord connection located in the rear of the system.

Only for U.S. operators: Use only a certified (UL-listed), removable power cord, type SJT, minimal 18 AWG, 3 leads. The plug connectors must comply with NEMA 5-15 or IEC 320/CEE22. Grounding will only be reliable if the equipment is connected to a corresponding hospital grade outlet.

Integrate the system into the potential equalization system as specified by local safety rules and regulations.

Medical devices are subject to special safety and protective measures concerning electromagnetic compatibility (hereafter abbreviated as EMC).

This system is to be used only for the purposes described in the manual and has to be installed, set up, and operated in compliance with the EMC notes and instructions. See Chapter 13: Electromagnetic Compatibility.

Chapter 13: Electromagnetic Compatibility

This chapter provides information about the electromagnetic compatibility of the Fluent Fluid Management System.

Guidance and Manufacturer's Declaration

Electromagnetic Emissions

The FLUENT FLUID MANAGEMENT SYSTEM is intended for use in the electromagnetic environment specified below. The customer or the user of the FLUENT FLUID MANAGEMENT SYSTEM should assure that it is used in such an environment.

Emissions test	Compliance	Electromagnetic environment - guidance
RF emissions CISPR 11	Group 1	The FLUENT FLUID MANAGEMENT SYSTEM uses RF energy only for its internal function. Therefore, its RF emissions are very low and are not likely to cause interference in nearby electronic equipment.
RF emissions CISPR 11	Group 2	The FLUENT FLUID MANAGEMENT SYSTEM must emit electro-magnetic energy in order to perform its intended function. Nearby electronic equipment may be affected.
RF emissions CISPR 11	Class A	The FLUENT FLUID MANAGEMENT SYSTEM is suitable for use in all establishments other than domestic and those directly connected to the public low-voltage power supply network that supplies buildings used for domestic purposes.
Harmonic emissions IEC 61000-3-2	Complies	NOTE: The EMISSIONS characteristics of this equipment make it suitable for use in industrial areas and hospitals (CISPR 11 class A). If it is used in a residential environment (for which CISPR 11 class B is normally required) this equipment might not offer adequate protection to radio-frequency communication services. The user might need to take mitigation measures, such as relocating or re-orienting the equipment.
Voltage fluctuations / flicker emissions IEC 61000-3-3	Complies	

Guidance and Manufacturer's Declaration

Electromagnetic Immunity

The FLUENT FLUID MANAGEMENT SYSTEM is intended for use in the electromagnetic environment specified below. The customer or the user of the FLUENT FLUID MANAGEMENT SYSTEM should assure that it is used in such an environment.

Immunity test	IEC 60601 test level	Compliance level	Electromagnetic environment - guidance
Electrostatic discharge (ESD) IEC 61000-4-2	± 8 kV contact ± 15 kV air	± 8 kV contact ± 15 kV air	Floors should be wood, concrete or ceramic tile. If floors are covered with synthetic material, the relative humidity should be at least 30%.
Electrical fast transients / bursts IEC 61000-4-4	± 2 kV for power supply lines ± 1 kV for input / output lines	± 2 kV for power supply lines	Mains power quality should be that of a typical commercial or hospital environment.
Surge IEC 61000-4-5	± 1 kV line(s) to line(s) ± 2 kV line(s) to earth	± 1 kV line(s) to line(s) ± 2 kV line(s) to earth	Mains power quality should be that of a typical commercial or hospital environment.
Voltage dips, short interruptions and voltage variations on power supply input lines IEC 61000-4-11	0% UT (100% dip in the UT) for ½ cycle at 0°, 45°, 90°, 135°, 180°, 225°, 270°, and 315°	0% UT (100% dip in the UT) for ½ cycle at 0°, 45°, 90°, 135°, 180°, 225°, 270°, and 315°	Mains power quality should be that of a typical commercial or hospital environment. If the user/operator of the FLUENT FLUID MANAGEMENT SYSTEM requires continued operation during power mains interruptions, it is recommended that the FLUENT FLUID MANAGEMENT SYSTEM be powered from an uninterruptible power supply or battery.
	0% UT (100% dip in the UT) for 1 cycle and 70% (30% dip in the UT) UT for 25/30 cycles at 0°	0% UT (100% dip in the UT) for 1 cycle and 70% (30% dip in the UT) UT for 25/30 cycles at 0°	
	0% UT (100% dip in the UT) for 250/300 cycles	0% UT (100% dip in the UT) for 250/300 cycles	
Power frequency (50/60 Hz) magnetic field IEC 61000-4-8	30 A/m	30 A/m	Power frequency magnetic fields should be at levels characteristic of a typical location in a typical commercial or hospital environment.

Immunity test	IEC 60601 test level	Compliance level	Electromagnetic environment - guidance
<p>Conducted RF IEC 61000-4-6</p> <p>Radiated HF interference quantities according to IEC 61000-4-3</p>	<p>3 Vrms 150 kHz to 80 MHz</p> <p>6 Vrms in ISM Bands between 150kHz and 80 MHz</p> <p>3 V/m 80 MHz to 2.7 GHz</p>	<p>3 Vrms 150 kHz to 80 MHz</p> <p>6 Vrms in ISM Bands between 150kHz and 80 MHz</p> <p>3 V/m 80 MHz to 2.7 GHz</p>	<p>Portable and mobile RF communications equipment used no closer to any part of the FLUENT FLUID MANAGEMENT SYSTEM, including cables, than the recommended separation distance calculated from the equation applicable to the frequency of the transmitter.</p> <p>Recommended safety distance:</p> <p>$d = 1.2\sqrt{P}$ for 150 KHz to 80 MHz</p> <p>$d = 1.2\sqrt{P}$ for 80 MHz to 800 MHz</p> <p>$d = 2.3\sqrt{P}$ for 800 MHz to 2.7 GHz</p> <p>Where P as the maximum output power rating of the transmitter in watts [W] according to the transmitter manufacturer d as recommended separation distance in meters [m].</p> <p>Field strengths from fixed RF transmitters, as determined by an electromagnetic site survey ^a, should be less than the compliance level in each frequency range. ^b</p> <p>Interference may occur in the vicinity of equipment marked with the following symbol:</p> 

Note *: UT is the AC mains voltage prior to application of the test level.

Note 1: At 80 MHz and 800 MHz, the higher frequency range applies.

Note 2: These guidelines may not apply in all situations. Electromagnetic propagation is affected by absorption and reflection of structures, objects, and people.

a) Field strengths from fixed transmitters, such as base stations for radio (cellular/cordless) telephones and land mobile radios, amateur radio, AM and FM radio broadcast and TV broadcast cannot be predicted theoretically with accuracy. To assess the electromagnetic environment due to fixed RF transmitters, an electromagnetic site survey should be considered. If the measured field strength in the location in which the FLUENT FLUID MANAGEMENT SYSTEM is used exceeds the applicable compliance level above, the FLUENT FLUID MANAGEMENT SYSTEM should be observed to verify normal operation. If abnormal performance is observed, additional measures may be necessary, such as re-orienting or relocating the changing orientation or the location of the FLUENT FLUID MANAGEMENT SYSTEM.

b) Over the frequency range of 150 kHz to 80 MHz, field strengths should be less than 3 V/m.

Recommended Separation Distances

The following lists the recommended separation distances between portable and mobile RF communications equipment and the FLUENT FLUID MANAGEMENT SYSTEM.

Recommended Separation Distances

The FLUENT FLUID MANAGEMENT SYSTEM is intended for use in an electromagnetic environment in which radiated RF disturbances are controlled. The customer or the user of the FLUENT FLUID MANAGEMENT SYSTEM can help prevent electromagnetic interference by maintaining a minimum distance between portable and mobile RF communications equipment (transmitters) and the FLUENT FLUID MANAGEMENT SYSTEM as recommended below, according to maximum output power of the communications equipment.

Rated maximum output power of transmitter [W]	Separation distance according to frequency of transmitter [m]		
	150 kHz to 80 MHz $d = 1.2\sqrt{P}$	80 MHz to 800 MHz $d = 1.2\sqrt{P}$	800 MHz to 2.7 GHz $d = 2.3\sqrt{P}$
0.01	0.12	0.12	0.23
0.1	0.38	0.38	0.73
1	1.2	1.2	2.3
10	3.8	3.8	7.3
100	12	12	23

For transmitters rated at a maximum output power not listed above, the recommended separation distance d in meters (m) can be estimated by using the equation applicable to the frequency of the transmitter, where P is the maximum output power rating of the transmitter in watts [W] according to the transmitter manufacturer.

Note 1: At 80 MHz and 800 MHz, the separation distance for the higher frequency range applies.

Note 2: These guidelines may not apply in all situations. Electromagnetic propagation is affected by absorption and reflection from structures, objects, and people.

Chapter 14: Disposables and Accessories

This chapter lists the accessories that are available for use with the Fluent Fluid Management System.

Accessories

The following accessories are available.

Item	Order Number
Fluent Fluid Management System Pack of Six Procedure Kits (In-FloPak, Out-FloPak, Tissue Trap and Waste Bag)	FLT-112
Fluent Fluid Management Waste Bag - Five Pack	FLT-005
Fluent Fluid Management Tissue Trap - Ten Pack	FLT-010
Compatible with MyoSure Tissue Removal Device	10-403
Compatible with MyoSure Lite Tissue Removal Device	30-403LITE
Compatible with MyoSure Reach Tissue Removal Device	10-403FC
Compatible with MyoSure XL for Fluent Tissue Removal Device	50-603XL
500g Weight	MME-03095
Fluent Power Cord	ASY-11124
Fluent Basket	FAB-13444

Chapter 15: Service and Warranty Information

This chapter provides information about the recommended maintenance interval and certification, technical support and the warranty.

Authorized Service Technician Maintenance

Two-year maintenance interval

It is recommended that a Hologic Personnel services the system at appropriate intervals to ensure safety and functionality. The minimum service interval is two years, depending on frequency and duration of use.

If this interval is not maintained, the manufacturer does not assume any liability for the functional safety of the system. A sticker located on the rear panel of the system contains the latest date for the next service or maintenance check.

Warranty Information

Except as otherwise expressly stated in the Agreement: i) Equipment manufactured by Hologic is warranted to the original Customer to perform substantially in accordance with published product specifications for one (1) year starting from the date of shipment, or if Installation is required, from the date of Installation ('Warranty Period'); ii) digital imaging mammography x-ray tubes are warranted for twenty-four (24) months, during which the x-ray tubes are fully warranted for the first twelve (12) months and are warranted on a straight-line prorated basis during months 13-24; iii) replacement parts and remanufactured items are warranted for the remainder of the Warranty Period or ninety (90) days from shipment, whichever is longer; iv) consumable Supplies are warranted to conform to published specifications for a period ending on the expiration date shown on their respective packages; v) licensed Software is warranted to operate in accordance with published specifications; vi) Services are warranted to be supplied in a workman-like manner; vii) non-Hologic Manufactured Equipment is warranted through its manufacturer and such manufacturer's warranties shall extend to Hologic's customers, to the extent permitted by the manufacturer of such non-Hologic Manufactured Equipment. Hologic does not warrant that use of Products will be uninterrupted or error-free, or that Products will operate with non-Hologic authorized third-party products.

These warranties do not apply to any item that is: (a) repaired, moved, or altered other than by Hologic authorized service personnel; (b) subjected to physical (including thermal or electrical) abuse, stress, or misuse; (c) stored, maintained, or operated in any manner inconsistent with applicable Hologic specifications or instructions, including Customer's refusal to allow Hologic recommended Software upgrades; or (d) designated as supplied subject to a non-Hologic warranty or on a pre-release or 'as-is' basis.

Technical Support and Product Return Information

Contact Hologic or your representative if the Fluent Fluid Control System fails to operate as intended. If product is to be returned to Hologic for any reason, Technical Support will issue a Returned Materials Authorization (RMA) number. Return Fluent Fluid Management System according to the instructions provided by Technical Support. Be sure to clean the Fluent Fluid Management System with a clean damp cloth and germicide or isopropyl alcohol before returning it and include all accessories in the box with the returned unit.

Hologic and its distributors and customers in the European Community are required to comply with the Waste Electrical and Electronic Equipment (WEEE) Directive (2002/96/EC). Hologic is dedicated to meeting country specific requirements related to the environmentally sound treatment of its products.

Hologic's objective is to reduce the waste resulting from the disposal of its electrical and electronic equipment. Hologic realizes the benefits of subjecting such WEEE to potential reuse, treatment, recycling or recovery to minimize the amount of hazardous substances entering the environment.

Hologic customers in the European Community are responsible for ensuring that medical devices marked with the following symbol, indicating that the WEEE Directive applies, are not placed into a municipal waste system unless authorized to do so by local authorities.

Contacting Hologic Technical Support

Contact Hologic Technical Support to arrange for proper disposal of the Fluent Fluid Management System in accordance with the WEEE Directive.

Hologic Technical Support

United States and Canada:















Hologic, Inc.
250 Campus Drive
Marlborough, MA 01752 USA
Phone: 1.800.442.9892 (toll-free)
www.hologic.com











Authorized European Representative:



Hologic BVBA
Da Vincilaan 5
1930 Zaventem
Belgium
Phone: +32 2 711 46 80
Fax: +32 2 725 20 87

Symbols

Symbols	Definitions
	Consult Instructions For Use
	Do not use if package is damaged
	Do not re-use
	Patient contact parts not made with DEHP
	Sterilized using ethylene oxide
	Do not re-sterilize
	Manufacturer
	Authorized representative in the European Community
	Catalog Number
	Quantity
	Batch code
	Serial number
	Atmospheric pressure limitation

Symbols	Definitions
	Humidity limitation
	Temperature limit
	Combined weight of the equipment and its safe working load
	Category non-AP equipment
	Type BF applied part
	Discard electrical and electronic equipment separately from standard waste. Equipment to be disposed in compliance with European Directive 2002/96/EC on Waste Electrical and Electronic Equipment (WEEE).
	Do not stack
	This way up
	Contents
	Keep Dry
	Follow instructions for use. This symbol appears in Blue on the label.
Rx ONLY	Caution: Federal Law (U.S.A.) restricts this device to sale by or on the order of a physician.
	Power on
	Power off

Symbols	Definitions
IP21	$N_1 =$
	0 Non-protected
	2 Protected against solid foreign objects of 12.5 mm \varnothing and greater
	$N_2 =$
	1 Protection against vertically falling water drops

Glossary

Term	Definitions
Contamination Soiling	Pollution of rooms, water, foods, objects, or persons due to microorganisms or radioactive materials, biological poisons or chemical agents
Contraindication	Circumstances (e.g., age, pregnancy, certain illness, medication) prohibiting the use of an otherwise indicated measure (contrary to an indication)
Deficit	The total amount of fluid left in the patient or unaccounted for otherwise. The fluid left in the patient must be monitored.
Embolism	Obstruction of a blood vessel by a clot or air bubble
Flow rate	Quantity (in mL) of irrigation fluid flowing through the tube set per minute.
Hypervolemia	An increased volume of circulating blood.
Hyponatremia	A low concentration (< 130 mmol/L) of sodium in the patient's bloodstream.
Hysteroscope	An instrument designed to provide visual examination of the uterus
Intrauterine pressure	The pressure in the uterine cavity.
Intravasation	Entry of foreign material (distention fluid) into the blood vessels
Saline	Isotonic saline solution, i.e., one liter (L) contains 9.0 grams of sodium chloride.
Tissue Trap	A component between the waste outflow and waste bag that separates tissue from fluid and collects resected tissue throughout the procedure to allow the tissue to be sent to pathology for testing.
TRD	Tissue Removal Device
UB Drape	Under Buttocks Drape