

Compass™ Stainer Operator's Manual

HOLOGIC®



Hologic, Inc.
250 Campus Drive
Marlborough, MA
01752 USA
Tel: 1-800-442-9892
1-508-263-2900
Fax: 1-508-229-2795
Web: www.hologic.com

EC REP

Hologic BV
Da Vincilaan 5
1930 Zaventem
Belgium

Australian Sponsor:
Hologic (Australia and
New Zealand) Pty Ltd
Suite 302, Level 3
2 Lyon Park Road
Macquarie Park
NSW 2113
Australia
Tel: 02 9888 8000

UK Responsible
Person:
Hologic, Ltd.
Oaks Business Park
Crewe Road
Wythenshawe
Manchester
M23 9HZ
United Kingdom

© Hologic, Inc., 2022. All rights reserved. No part of this publication may be reproduced, transmitted, transcribed, stored in a retrieval system, or translated into any language or computer language, in any form, or by any means, electronic, mechanical, magnetic, optical, chemical, manual, or otherwise, without the prior written permission of Hologic, 250 Campus Drive, Marlborough, Massachusetts, 01752, United States of America.

Although this guide has been prepared with every precaution to ensure accuracy, Hologic assumes no liability for any errors or omissions, nor for any damages resulting from the application or use of this information.

Hologic and Compass are trademarks and/or registered trademarks of Hologic, Inc. or its subsidiaries in the United States and other countries. All other trademarks are the property of their respective owners.

Changes or modifications to this unit not expressly approved by the party responsible for compliance could void the user's authority to operate the equipment.

Document Number: AW-23958-001 Rev. 001

9-2022



Revision History

Revision	Date	Description
AW-23958-001 Rev. 001	9-2022	Clarify intended use. Add instructions regarding reporting serious incidents. Add UK CA mark.

This page intentionally left blank.



TABLE OF CONTENTS

OVERVIEW OF THE COMPASS™ STAINER.....	5
Intended Use	5
Materials Provided	6
TECHNICAL SPECIFICATIONS	6
Electrical Characteristics	6
Power Input	6
Fuse Rating.....	6
Display	6
Keyboard	6
USB Flash Drive Interface	6
Physical Characteristics	6
Operating Environmental Conditions	7
Storage/Transportation Conditions	7
Functional Capabilities.....	7
Installation Category.....	7
Pollution Degree	7
Compass Stainer System Standards.....	8
Compass Stainer System Hazards	8
Symbols Used On the Instrument	9
Location of Labels on the Instrument	11
Important Safety and Operational Information.....	12
Disposal	12
Disposal of the Instrument.....	12
Disposal of Waste Electrical and Electronic Equipment (WEEE).....	12
Your Responsibility.....	12
Symbol Used on the Instrument.....	12
Reclamation	13
INSTALLATION	14



Action Upon Delivery	14
Preparation Prior to Installation	14
Location	14
Moving the Compass Stainer	14
Storage and Handling Post Installation	15
Power on the Compass Stainer	15
Shutdown Procedure	16
System overview	16
Description of Various Functional Areas	17
Display	17
Fume Shield	17
Transport Arm Mechanism	17
USB Data Port	18
Keypad	18
OPERATION	21
Operating Procedure Overview	21
Run a Program	21
Start a Run - Single Rack	21
Pause or Stop a Run	23
Completion of a Run	24
Running Multiple Racks	24
Pause or Stop a Run of Multiple Racks	26
Completion of Multiple Racks	27
Create, Review and Edit Programs	27
Parameter Definitions	28
Parameter Entry/Selection Scheme	29
Create a New Program	30
Review and Edit a Program	32
Insert a Step	33
Delete a Step	34



Utility Menu	35
Contrast.....	35
Agitation.....	36
Programs.....	36
Export	37
Import	37
Password Implementation.....	38
Event Log	39
MAINTENANCE	40
General Information	40
Routine Maintenance Schedule.....	40
Cleaning Procedures.....	40
Charcoal Filter Replacement (Once every 3 months, or as needed)	41
Changing the Fuses (as needed)	41
SERVICE INFORMATION	42
Corporate Address	42
Business Hours	44
Customer Service.....	42
Technical Support	42
Protocol for Returned Goods.....	43
ORDERING INFORMATION.....	44
Mailing Address	44
Remittance Address	44
Business Hours	44
Customer Service.....	44
Protocol for Returned Goods.....	44
OPTIONAL ACCESSORIES	45
TROUBLESHOOTING GUIDE.....	46
STAINING PROTOCOL, 95% Reagent Alcohol Fixed ThinPrep™ Slides for use with ThinPrep Imaging.....	47
Stain Protocol Worksheet.....	49



This page intentionally left blank.



OVERVIEW OF THE COMPASS™ STAINER

The Compass Stainer is an automated stainer designed for use in cytology/anatomical pathology laboratories as a stand-alone, benchtop unit for staining histologic and cytologic samples on slides.

The Compass Stainer must be operated only by trained laboratory personnel. As with all laboratory procedures, universal precautions should be followed.

The Compass Stainer offers flexibility and programmability for routine and special stains of samples mounted on glass slides. This bench top unit contains 24 stations. Specific functions of some of these stations are as follows.

Station Number/Name	How Many	Function
LOAD	1	Load Station
UNLOAD	1	Unload Station
1 - 22	22	Reagent Stations

The stations are organized in a circular fashion and are numbered in clockwise direction on the platform. LOAD and UNLOAD Stations are located in the front of the unit. The station numbers for the reagent stations (1 – 22) are clearly laser etched on the platform.

This manual covers information about initial set up, programming test protocols, and slide staining operations only.

These instructions are not for use in the United States. If you are in the United States, follow the instructions in the file called “US English” with the part number AW-27500-001. The instructions for using the Compass Stainer are the same regardless of the instrument color.

The system must be operated only according to the instructions contained in this manual and only for its intended use as defined in this manual. **Any other use of the system is considered improper and voids the warranty!**

Intended use

The Compass Stainer is an automated stainer designed for use in cytology/anatomical pathology laboratories as a stand-alone, benchtop unit for staining histologic and cytologic samples on slides. For professional use.



Materials Provided

The following items are included when the Compass Stainer is delivered for installation. (These items may vary according to your order.)

Part Number	Description	Quantity
ASY-05576	Compass Stainer	1
OEM-01078	Reagent Containers with Lids	24
51873-001	Sakura 20-Slide Rack	4
OEM-01100	Adapter (Hanger) for Sakura or Leica Slide Rack	4
50077-013	Fuse (pack of 2 fuses)	1 spare set (1 set installed in the unit)
5008*-001	Line Cord (* country specific)	1
MAN-08472-001	Operator's Manual, English Text and CD with translations	1
OEM-01081	Charcoal filter	2
OEM-01084	Fume Shield	1

TECHNICAL SPECIFICATIONS

Electrical Characteristics

Power Input

Voltage: 100–230 VAC, 50/60 Hz

Power: 1.0 Amp max

Fuse Rating

1 Amp x 250 volts Slo-Blo (Time Delayed) fuse

Display

5 volts dc, max 0.5 amp, 8 lines x 20 characters per line presentation, LCD with white LED back light.

Keyboard

Membrane keypad with 20 keys

USB Flash Drive Interface

USB 2.0 (low power) Flash Drive interface to exchange Programs

Physical Characteristics

Dimensions:

Width: 32" (81 cm) Additional required clearance 6" (15 cm)

Depth: 31" (79 cm) Additional required clearance 6" (15 cm)

Height: 16" (41 cm) Additional required clearance 12" (30 cm)



Weight:

Actual Weight: 55 lbs (25 kg) Max – without reagents in the container

Shipping Weight: 110 lbs (52 kg)

Operating Environmental Conditions

All Compass Stainer products are laboratory systems and should be used ONLY in laboratories with the following conditions:

Indoor use Only

Ambient Temperature 15° C to 35° C (59° F to 95° F)

Relative Humidity 20-80% non-condensing

Ambient Pressure 29"-31" (740-790 mm) of Hg

Altitude Less than 6500 feet (Less than 2000 Meters)

Storage/Transportation Conditions

Temperature 10-40°C (50 to 102°F)

Humidity 15-80% non-condensing

Pressure 28"-32" (70-80 mm) of Hg

Functional Capabilities

Number of Stations 24

Dedicated Stations 2: one Load Station and one Unload Station

Reagent Stations 22

Reagent Volume 350 - 360 ml

Number of Programs Up to 15

Steps in a Program Up to 35

Step Duration 10 seconds up to 99 Minutes 59 Seconds per step
(programmable in 1 second increments)

Simultaneous Processing Up to 4 reagent racks at a time

Installation Category

In reference to Installation category as defined in UL 61010-1 standard, the Compass Stainer products are categorized as Category II systems.

Pollution Degree

In reference to Pollution Degree as defined in UL 61010-1 standard, the Compass Stainer products are categorized as Pollution Degree 2



COMPASS STAINER SYSTEM STANDARDS

This system has been built and tested in accordance with the following safety regulations on electrical measuring, control, regulating and laboratory devices: IEC 61010 – 1, 2nd Edition.

Electrical equipment for laboratory use.

Compass Stainer System Hazards

The Compass Stainer is intended to be operated in the manner specified in this manual. Be sure to review and understand the information listed below in order to avoid harm to operators and/or damage to the instrument.

If this equipment is used in a manner not specified by the manufacturer, then the protection provided by the equipment may be impaired.

If any serious incident occurs related to this device or any components used with this device, report it to Hologic Technical Support and the competent authority local to the user and/or patient.

Warnings, Cautions and Notes

The terms **Warning**, **Caution** and **Note** have specific meanings in this manual.

A **Warning** advises against certain actions or situations that could result in personal injury or death.

A **Caution** advises against actions or situations that could damage equipment, produce inaccurate data or invalidate a procedure, although personal injury is unlikely.

A **Note** provides useful information within the context of the instructions being provided.



Warning: Attention: This symbol on the system and in the manual showing the warning triangle indicate that the correct operating instructions (as defined in this manual) must be followed when operating or replacing the item marked.











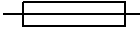

Failure to adhere to these instructions may result in an accident, personal injury, damage to the system or accessory equipment.

Warning: For continued protection against fire hazard, replace fuse with fuse of same type and rating.







Warning: Electrical shock hazard. Disconnect line cord before servicing. Refer servicing to qualified service personnel. To avoid the risk of injury from electrical shock, do not open the instrument's enclosure.



Symbols Used On the Instrument

	<p>Attention, refer to accompanying documents.</p>
	<p>Caution, risk of electric shock</p>
	<p>Fuse</p>
	<p>Waste Electrical and Electronic Equipment. Do not dispose in municipal waste. Contact Hologic for disposal of the instrument.</p>
	<p><i>In vitro</i> diagnostic equipment</p>
	<p>Consult instructions for use</p>
	<p>Serial number</p>
	<p>Manufacturer</p>
	<p>Date of manufacture</p>
	<p>Made in USA</p>
	<p>Information is applicable only in the USA and Canada</p>
	<p>Authorized Representative in the European Community</p>



	Catalogue number
	Product meets the requirements for CE marking in accordance with EU-IVD Regulation 2017/ 746
	UK Conformity Assessed (Great Britain)
	Caution: Federal (USA) law restricts this device sale by or on the order of a physician, or any other practitioner licensed by the law of the State in which the practitioner practices to use or order the use of the device and are trained and experienced in the use of the product.
	UL Listing means that UL has tested representative samples of a product and determined that the product meets specific, defined requirements.
	Power Supply ON indication. Push the Power ON/OFF switch in the direction marked with this symbol to turn the unit power on.
	Power Supply OFF indication. Push the Power ON/OFF switch in the direction marked with this symbol to turn the unit power off.



Location of Labels on the Instrument

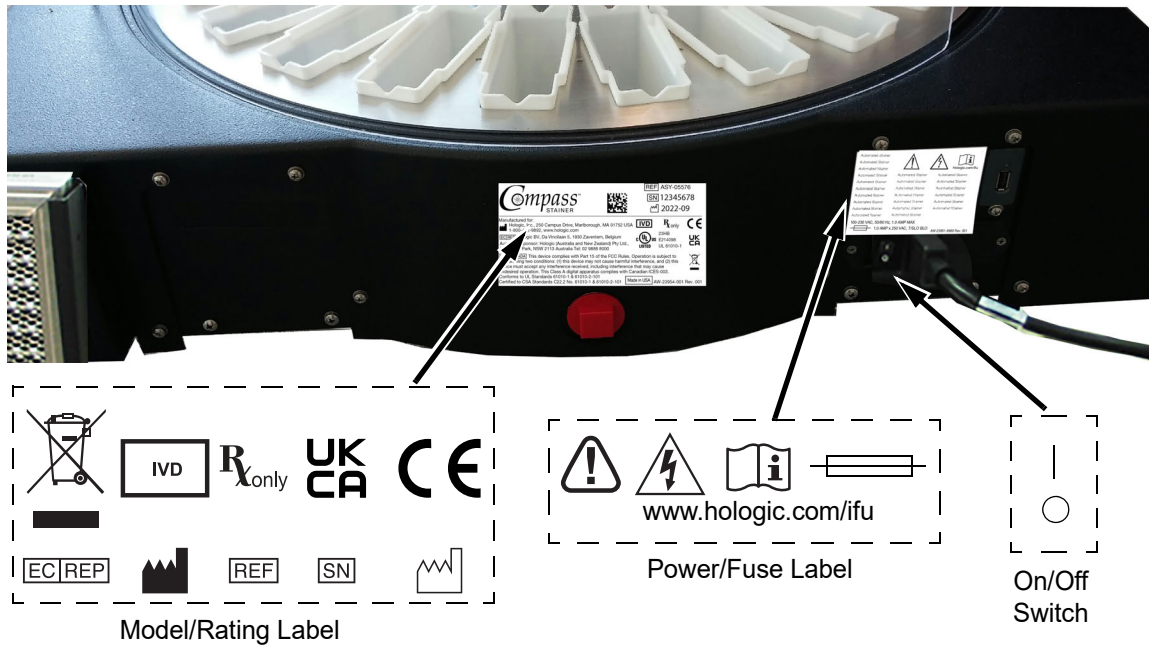

Figure 1-1 Rear of the Compass Stainer



Important Safety and Operational Information

- This instruction manual includes important information related to the operating safety and maintenance of the system and it is an important part of the product.
- Obtain, review and retain the Safety Data Sheets (SDS) for the reagents used from the manufacturers of the reagents. Follow the safety precautions and disposal recommendations provided in SDS.
- Caution - flammable liquids. Keep away from fire, heat, sparks and flame. Be sure to close the fume shield cover when instrument is in use.
- Caution - glass. This instrument processes microscope slides, which have sharp edges. Use caution when handling glass slides.
- Caution - moving parts. Be sure to keep hands away from the transport arm mechanism while the instrument is operating. Keep the fume shield doors closed while running the instrument.
- As with all laboratory procedures, universal precautions should be followed.

Disposal

The system or the parts of the system must be disposed of according to prevailing local applicable regulations.

Disposal of the Instrument

Disposal of Waste Electrical and Electronic Equipment (WEEE)

Hologic is dedicated to meeting country specific requirements associated with the environmentally sound treatment of our products. Our objective is to reduce the waste arising from our electrical and electronic equipment. Hologic realizes the benefits of subjecting such WEEE equipment to potential reuse, treatment, recycling or recovery to minimize the amount of hazardous substances entering the environment.

Your Responsibility

As a Hologic customer, you are responsible for ensuring that devices marked with the symbol shown below are not placed into the municipal waste system unless authorized to do so by the authorities in your area. Please contact Hologic (see below) prior to disposing of any electrical equipment provided by Hologic.

Symbol Used on the Instrument



Do not dispose in municipal waste.

Contact Hologic (see below) for information regarding proper disposal.



Reclamation

Hologic will provide for the collection and proper reclamation of electrical devices we provide to our customers. Hologic strives to reuse Hologic devices, subassemblies, and components whenever possible. When reuse is not appropriate, Hologic will ensure the waste material is properly disposed of.

<p>Manufacturer/Corporate Headquarters</p> 	<p>Hologic, Inc. 250 Campus Drive Marlborough, MA 01752 USA Tel: 1-800-442-9892 1-508-263-2900 Fax: 1-508-229-2795 web:www.hologic.com</p>
<p>Authorized Representative - Europe</p> 	<p>Hologic BV Da Vincilaan 5 1930 Zaventem Belgium</p>



INSTALLATION

WARNING: Service installation only.

The Compass Stainer must be installed by personnel who have completed Hologic Service Training.

Action Upon Delivery

Inspect the packing cartons for damage. Report any damage immediately to the shipper and/or Hologic Technical Support as soon as possible.

Leave the instrument in the packing cartons for Hologic Service installation.

Store the instrument in a suitable environment until installation (cool, dry, vibration-free area).

Retain all packaging material for the duration of the warranty period.

Preparation Prior to Installation

A pre-installation site assessment is performed by Hologic Service Personnel. Be sure to have prepared any and all site configuration requirements as instructed by Service personnel.

Location

Locate the Compass Stainer near (within 3 meters) a 3-wire grounded power outlet that is free of voltage fluctuations and power surges. If your system is configured with the optional UPS (uninterruptable power supply), the UPS will be plugged into the electrical outlet and the stainer plugged into the UPS.

Be sure the table or bench where the stainer is located can support a weight of 100 lbs (46 kg). The system must be on a vibration-free surface.

The Instrument must be installed in an area in the laboratory that is well ventilated and free from any ignition sources. The chemicals used in the Compass Stainer are flammable and noxious and the system should not be operated in rooms with explosion hazards.

The instrument must not be located in direct sunlight or under a source of light that has a high ultra violet light content.

If the laboratory's bench depth is too shallow, the instrument may be allowed to overhang the table by no more than 7 inches (18 cm). For stability, the rear 8 feet must be securely positioned on the table.

Note: Adequate clearance is necessary on the rear of the instrument.

Please review the section on hazards and safety before operating this unit (page 1.12).

Moving the Compass Stainer

CAUTION: the system weighs approximately 55 lbs (25 kg) and should always be moved by at least two people.



The Compass Stainer should be handled with care. Prior to relocating the stainer, unload any items which may spill or break. Shut down the stainer. Disconnect power to the unit by removal of the power cord from the electrical outlet or the UPS, depending on your configuration.

If the stainer must be moved, it should be grasped and lifted by the bottom of the housing.

If the stainer is to be shipped to a new location, please contact Hologic Technical Support. (Refer to Service Information, page 1.42.)

Storage and Handling Post Installation

The Compass Stainer may be stored where it is installed. Be sure to clean and maintain the stainer as described in the Maintenance section of this manual, page 1.40.

Power on the Compass Stainer

WARNING: Grounded Outlet, Moving Parts

The power switch to the stainer is located on the rear of the unit. Refer to Figure 1-3. Press the rocker switch to the ON position. The interface will display software version and a message that the mechanisms are initializing while the system starts up and then standby screen will appear when the stainer is ready for use.

Note: The Compass Stainer can be left ON or you can choose to power it down when not in use. For shut down or extended shut down, see page 1.16.

```
COMPASS STAINER

HOST SW: 2.00
IOC SW: 0.85

REMOVE ALL RACKS
PRESS ENTER
```

Startup Display

```
COMPASS STAINER

ADD SLIDES AT
LOAD STATION,
THEN PRESS RUN.
```

Standby Display

The startup display shows the software versions of Master Controller software and IO Controller Software. It also prompts the user to remove all sample slide racks from the system before the system begins mechanism initialization.

When the user presses the ENTER key, the system assumes that there are no racks in the system and that the user's hand or fingers are not obstructing the path of the transport mechanism. While the system initializes the transport mechanism, the transport mechanism can move across the UNLOAD and LOAD stations. During normal operation of the system the transport arm never crosses from UNLOAD to LOAD stations to avoid accidental obstruction by the user while loading or unloading a sample rack.



Shutdown Procedure

Remove all racks, cover all baths, close the fume shield.

The Stainer can be left ON when not in use or it can be powered down.

To power down, press the On/Off switch on the rear of the stainer to OFF.

For **extended** shutdown or if the stainer is to be taken out of service, remove any items that may be on board and close the fume shield. Press the On/Off switch on the rear of the stainer to OFF.

Completely remove power to the stainer by unplugging the power cord from the power source.

System overview

Major functional areas of the Compass Stainer are shown in the following figures.

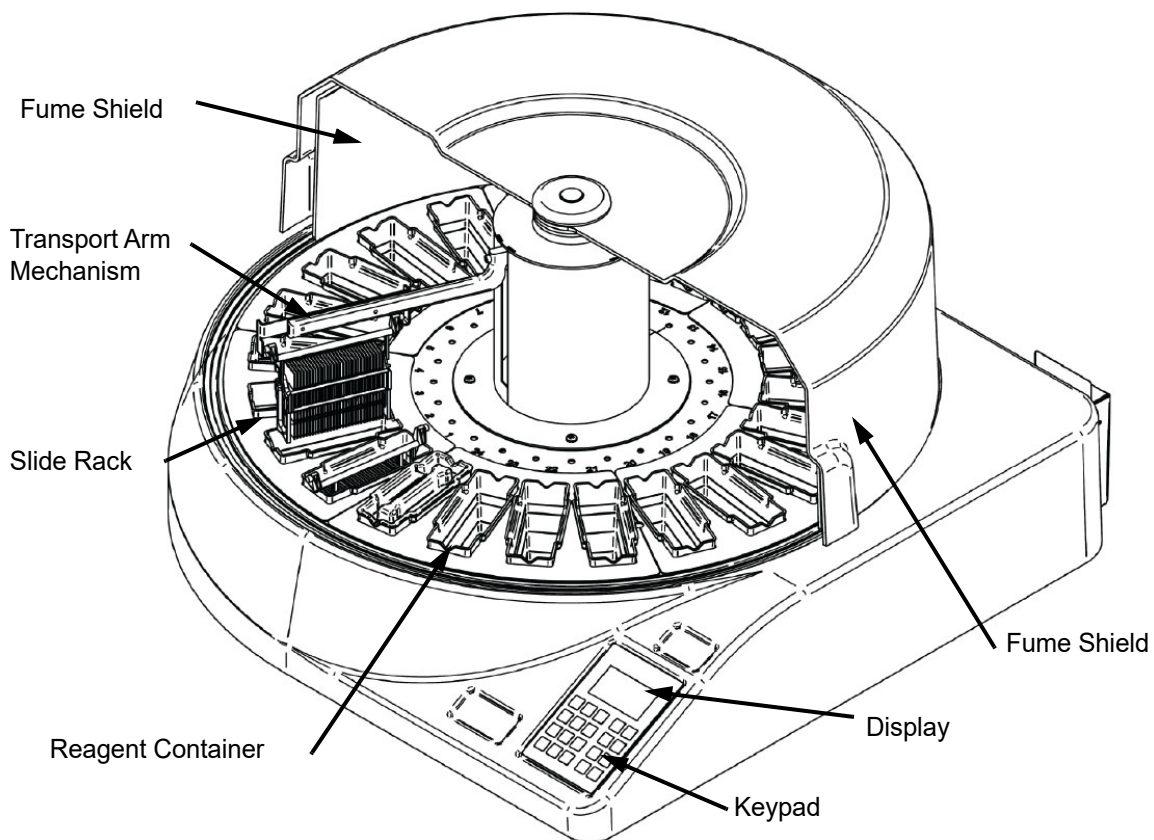

Figure 1-2 Compass Stainer - Front View

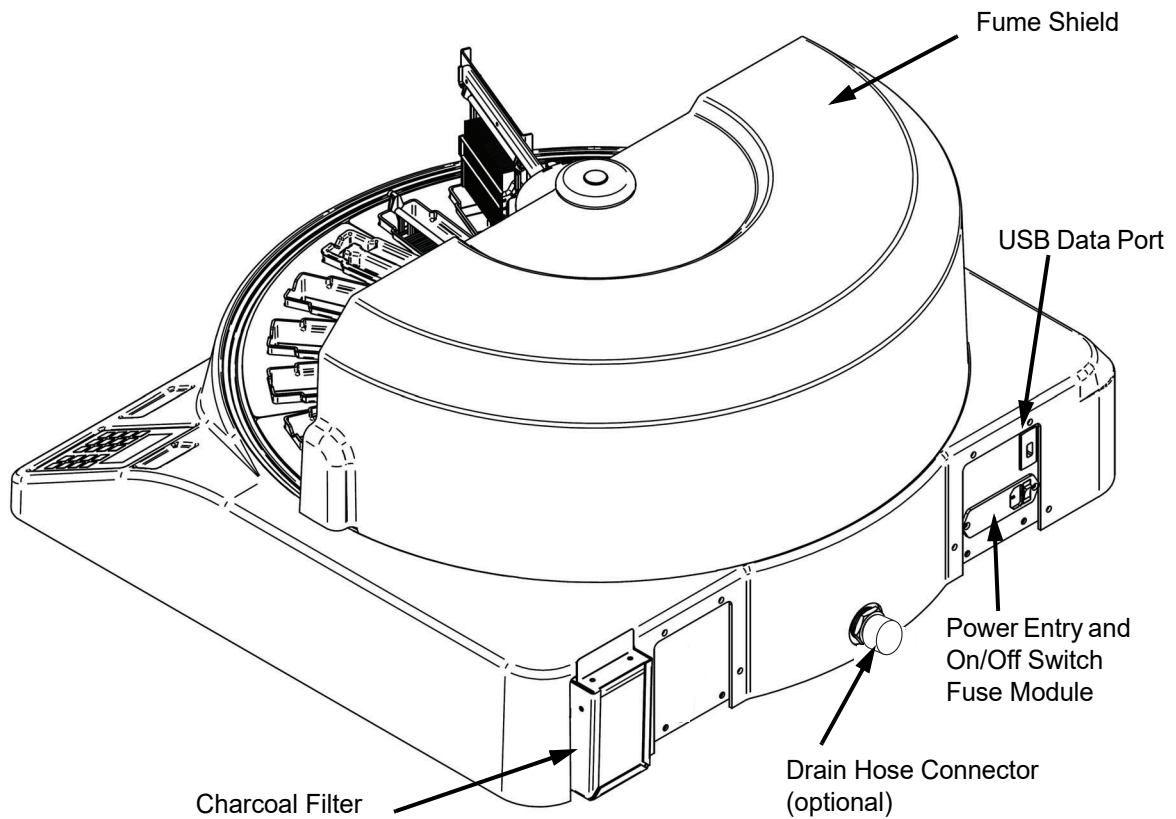

Figure 1-3 Compass Stainer - Rear View

Description of Various Functional Areas:

Display The Compass Stainer uses a 20 character wide x 8 line alpha-numeric passive LCD display for an operator interface. The user can adjust the contrast of the displayed information in the service mode to obtain the clearest text, based on User's viewing angle.

Fume Shield The cover helps minimize the reagent fumes escaping to the ambient air. It also allows the user to observe the progress of the processing.

The Transport Arm Mechanism The transport arm mechanism provides two types of travel to the slide rack – up/down (z-axis) and rotary. Up/down motion allows immersing, agitating and removing of the sample slide racks from a reagent station and the rotary motion transports the slide rack from one station to another station.



USB Data Port The operator can use one of the Utilities to upload the user programs to an optional external flash drive. The USB Flash Drive must be inserted into the USB Port in the rear of the unit. The Utility mode software also allows for downloading programs from the drive.

It should be noted that when programs are downloaded, all the programs in the system memory are erased except for Program 1 (ThinPrep Imaging protocol) and only the programs in the USB Flash Drive are loaded.

Keypad

The Compass Stainer uses a membrane-style keypad with 20 keys. For user convenience, the keys are arranged in three functional groups. The first group is for numeric entry; it includes the number keys (0 – 9), CLEAR and ENTER. The second group is for programming and running the specimen processing protocols, and includes the RUN, PROG, REVIEW and STOP keys. The third group, consisting of the UP and DOWN ARROW keys, UTIL and SVC, is used to set up and maintain the system.



Figure 1-4 Compass Stainer Keypad

The keypad has the following Keys:

KEY	FUNCTION
-----	----------

0-9:	These keys are used to provide a numeric entry.
------	---



CLEAR: Use this key to delete a programmed step from a processing protocol. Press the CLEAR key when requested to erase stored information (e.g. to delete Stored Programs).

ENTER: Use this key to accept or confirm the Numeric Data entry just made.



Arrow Keys are used to scroll through selection menus, and to raise and lower the transport mechanism.

RUN: Use this Key to initiate a RUN.

PROG (PROGRAM): Use this key to start entering processing steps for a new program.

UTIL (UTILITY): This key allows access to various Utility functions to set up the system as well as to view the status of the last Run.

REVIEW: Use this key to review programs that have previously been created and to edit programs that have previously been stored.

SVC (SERVICE): This key provides access to various functions for servicing and troubleshooting the system. Access to the Service Mode Function is password protected and is intended for Hologic Service Personnel use only.

STOP: This Key is used to either Pause or Stop a Run in progress or exit various Operator Interaction Modes.

The user interactions with the system are divided into the following categories:

1. Program, Review and Edit processing protocols
2. Running programmed protocols
3. Utility Functions (System setup, Review Last Run, etc.)
4. Service Functions (Troubleshooting information)



The system powers up in the Standby Mode. During Standby mode the mechanisms are not moving. From Standby mode, the user must press ENTER to initialize the system - the transport arm moves clockwise through all positions, stopping at Station1.

The user can start a slide staining run by pressing the RUN key or select the UTILITY mode by pressing UTIL. Once in RUN mode, the user can add another rack without exiting the RUN mode or can initiate a PAUSE or CANCEL the run. Once the run is completed for all the racks that are running, the system will enter the Standby Mode.

Several examples of display and keypad interactions are described below to clarify some of the conventions and the nomenclature used in the displayed messages. Please contact Technical Support if you have any questions or need further assistance.



OPERATION

Operating Procedure Overview

1. Power ON, refer to page 1.15 for instructions.
2. Press ENTER to initialize the system.
3. Ensure that all stations have reagent containers.*
4. Remove all the lids from the reagent containers.*
5. Remove all slide racks (if any are present) from the Stainer. *

* Note that the UP arrow can be pressed to elevate the transport arm if it is blocking access to a station. Be sure to press the DOWN arrow when finished.

6. Ensure that proper reagents are loaded in the Stainer at proper locations for the protocols that you will be running.
7. Place a rack of slides in the LOAD station.
8. Press the RUN key. The system will prompt for the desired program number, which the user enters via keypad and presses ENTER again.
9. The system will confirm that the selected program exists in the non-volatile memory. If the program exists in the system memory, the system will prompt for pressing the ENTER key to continue. The system initializes the mechanisms and the rack will be picked up within next 10 seconds. The processing will begin.
10. Once the rack has been picked up from the Load Station, you can add another rack for processing.
11. When the staining is completed, the Stainer will put the processed rack in the UNLOAD station. Remove the rack from UNLOAD station and press ENTER to notify the system that the rack has been removed and it is okay to place another rack in the UNLOAD station. Failure to remove the processed rack in a timely manner may delay the processing of the other racks.

Run a Program

Start a Run - Single Rack

To start a program, first load the reagents needed for the staining program in proper sequence. Ensure that there are no racks or any other obstructions for the transport mechanism. Load the slides for staining in a slide rack and place the rack in the LOAD station and close the fume shield cover.

Press the RUN key and the software will prompt for the program number as shown below:

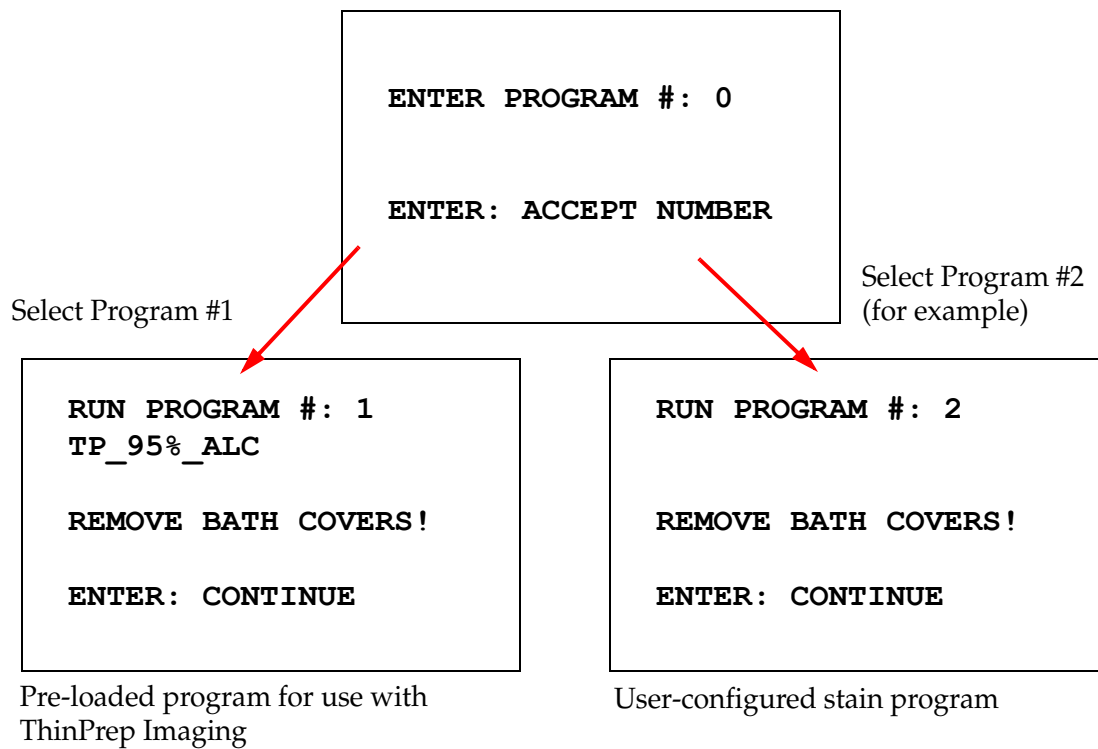

Once a desired program number is entered (program number followed by the ENTER key), the software will check if the selected program exists in the memory. If the program exists in the memory, the system will start the execution of the program once the user presses ENTER.

The transport mechanism is initialized first and “**MOVING THE RACK...**” message is displayed. Once the rack is at a station, the run time status is displayed as follows:



If the user presses the STOP key to cancel the run, the following screen is displayed.

**RUN WAS CANCELLED!
REMOVE THE RACKS,
THEN PRESS ENTER.**

The user can press the up or down arrow keys to move the transport mechanism at this point to lift the rack from the reagent station and remove it without pushing the transport mechanism sideways.

Completion of a Run

When processing of a rack is completed, the system drops the completed rack in the UNLOAD Station, beeps 5 times and prompts the user to remove the rack. Only after the user confirms that the rack is removed by pressing ENTER, can the system begin the next run.

When the user presses the ENTER key after removing the rack, the transport mechanism is re-initialized and the Standby Screen is displayed.

**REMOVE SLIDE RACK
FROM UNLOAD STATION
THEN PRESS ENTER.**

System prompts user to remove the slide rack from the UNLOAD station.

**COMPASS STAINER
ADD SLIDES AT
LOAD STATION,
THEN PRESS ENTER.**

The System returns to the standby display

Run Multiple Racks

The Compass Stainer is designed to run multiple slide racks at the same time and optimizes a schedule to reduce overall staining time while respecting any steps with critical timing. The following guidelines apply when running multiple racks in the stainer simultaneously.



- If subsequent racks are run after the first rack has begun, the system will only run the same program for the other racks.
- The user must wait until a rack is picked up from the Load Station.
- When a rack is already running and a new slide rack is inserted into the Load Station, the software must determine the optimal schedule to run all racks simultaneously. This processing may take several seconds so a "Please Wait..." message will appear on the screen. Please note that the stainer will finish any current motions before the scheduling calculation begins.
- When a new slide rack is inserted and the stainer is in the middle of processing an existing rack in a station marked as critical (Step Criticality=Yes), the scheduling of the new rack may be delayed. Once the existing rack has exited the critical station the new rack will be scheduled as usual.
- Running multiple racks at the same time is more efficient than waiting until each rack is completed before starting the next one. However there are situations when there is insufficient time to process additional racks and not adversely affect the racks already in progress. In those situations the new rack may not start processing immediately and its processing may be delayed until the completion of the racks currently being processed. It is recommended that each user analyze the set of steps that will be run and the desired throughput to determine the maximize number of racks to run at one time.
- The user should remove the processed racks as soon as possible to avoid delays and extension of station times for the remainder of the racks.
- The Compass Stainer can process up to four (4) racks simultaneously. It will not allow the user to start a fifth rack while other four racks are being processed. The rack # on the display will increment with each additional rack up to '4' and then return the counter to '1' if subsequent racks are added.

To add another rack, the user has to place the new rack at the LOAD station, press the RUN key and follow the prompts on the display.

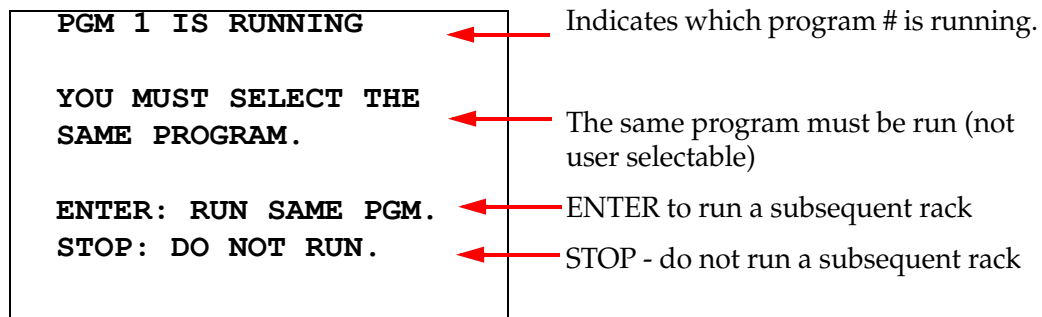

Press the ENTER key to proceed with a subsequent rack.



```
R: S: ST: PT:
 1 03 00:51 00:28:47
 2  _ _ : _ _ WAITING
 _ _ _ : _ _ : _ : _
 _ _ _ : _ _ : _ : _

RUN: ANOTHER RACK
STOP: PAUSE / CANCEL
```

Second rack waiting

```
R: S: ST: PT:
 1 04 06:26 00:25:55
 2 01 00:46 00:43:20
 _ _ _ : _ _ : _ : _
 _ _ _ : _ _ : _ : _

RUN: ANOTHER RACK
STOP: PAUSE / CANCEL
```

Second rack in progress

Load a third rack in the LOAD station and press RUN.

```
PGM 1 IS RUNNING

YOU MUST SELECT THE
SAME PROGRAM.

ENTER: RUN SAME PGM.
STOP: DO NOT RUN.
```

Same program message is displayed. RUN to continue

```
R: S: ST: PT:
 1 05 04:21 00:23:51
 2 03 00:10 00:41:36
 3 01 00:58 00:57:21
 _ _ _ : _ _ : _ : _

RUN: ANOTHER RACK
STOP: PAUSE / CANCEL
```

Third rack in progress

Pause or Stop a Run of Multiple Racks

To Pause or Stop the run, the user presses the STOP key and follows the prompt as displayed: press RUN to resume the run; press STOP to cancel the run.

```
***** PAUSE! *****

RUN: RESUME RUN.
STOP: CANCEL RUN.
```

Note: Cancel Run will cancel ALL racks in progress!!



Completion of Multiple Racks

When processing of a rack is completed, the system drops the completed rack in the UNLOAD station, beeps 5 times and prompts the user to remove the rack. Only after the user confirms that the rack is removed by pressing ENTER, will the system place another rack in the UNLOAD station. While a completed rack is waiting to be removed, the system will continue to process other racks (if they are already running) until it can no longer move a rack to its desired destination. At that point, all running racks will experience longer station times until the completed rack removal is acknowledged by the user.

```
REMOVE SLIDE RACK
FROM UNLOAD STATION,
THEN PRESS ENTER
```

System prompts user to remove the slide rack from the UNLOAD station. Note that the display stays at this screen until ENTER is pressed.

```
R:  S:  ST:   PT:
  _  _  _:  _  _:  _:  _
  2 03 00:10 00:41:36
  3 01 00:58 00:57:21
  _  _  _:  _  _:  _:  _

RUN: ANOTHER RACK
STOP: PAUSE / CANCEL
```

Example of rack 1 complete, while racks 2 and 3 continue processing.

When the user presses the ENTER key after removing all the racks, the transport mechanism is re-initialized and the Standby Screen is displayed.

Completion of Multiple Racks When Running the ThinPrep Stain Protocol

The system will remove racks when completed as explained previously but while a completed rack is waiting to be removed, the system will continue to process other racks (if they are already running) and place subsequent racks **in the last available "non-critical" station** until it can no longer move a rack to its desired destination.

Create, Review and Edit Programs

The Compass Stainer allows you to create, review, or modify programs (stain protocols). User-created protocols are identified only by their program number and cannot be given an alpha-numeric name.

When the system is in Standby mode, the user can:

- press PROG to begin programming a new protocol
- press REVIEW to look at the contents of a program that already exists, or to modify one or more steps of a pre-existing program



The Compass Stainer can store up to 15 staining protocols or programs, with the first one pre-loaded and locked to accommodate the ThinPrep™ Stain Protocol for use on the ThinPrep Imaging System. Each program can have up to 35 steps. While running a program the user must place appropriate reagents at proper stations for running a program. If the user desires to run multiple racks, only one program can be used for all racks in that series of runs.

Parameter Definitions

While programming a processing step, the following five parameters are entered for each step:

1. Station Number
2. Duration
3. Is Station Time Critical or Not
4. Is Agitation needed upon Rack Entry or Not
5. Exit Speed of the Rack upon completion of the station time

Station Number: The Compass Stainer has 24 stations. The stations are labeled as LOAD, UNLOAD and Stations 1-22. At LOAD Station a new rack is placed by the user. The system places the slide rack at UNLOAD Station upon completion of the staining program. While creating a Program, the user does not program LOAD and UNLOAD stations – these stations are implied and are always added in the Program. A valid Station Number value is between 1 and 22.

Duration: The time duration for a step ranges from 10 seconds (00:10) to 99 minutes and 59 seconds (99:59), programmable in 1 second increments. If a longer station time is desired, the user must select the next step at the same station with the remainder of the time. The system will pick up the rack momentarily out of the station and put it back in (with selected agitation).

Critical Time: Criticality is a feature that ensures a rack is not left submerged in a station for longer than the specified duration time. The selection choice is YES/NO. If the step is flagged as critical by selecting the "Yes" option, the duration at the selected station will not be extended to accommodate multiple rack processing.

Agitation: Agitation is a feature that relies on the Transport Mechanism Arm to move the slide rack in an up and down motion to ensure even stain distribution based on the agitation setting. Agitation can be turned on or off for a station by selecting "Yes" or "No", respectively. Agitation is performed only upon entry into a reagent station. Number of Agitation dips during agitation and the height of



the agitation dip are set up by a Utility Mode menu selection. These selections apply to all stations of all programs.

Exit Speed The Compass Stainer allows a selection between Normal and Fast exit speed. Normal speed allows the rack to be removed slowly to minimize reagent carry over from one station to next by allowing more time for the reagent to drain from the rack and slides.

Parameter Entry/Selection Scheme

ENTER The ENTER key accepts any new numerical data entry (if within a valid range) and advances to the next parameter option selection. If no new data entry was made, it simply advances to the next parameter selection.

Number Keys Number keys are used in two different ways. If a parameter field needs numerical data (Station Number and Station Time), the number keys provide that information. For other fields (Criticality, Agitation and Exit Speed) only 0 and 1 keys have specific meanings. By pressing 0, the user can select NO for Criticality and Agitation, and NORMAL SPEED for the Exit speed. By pressing 1, the user can select YES for Criticality and Agitation, and FAST Speed for the Exit speed.

Arrow Keys Allows the user to go from one step to another. In Program Mode, pressing the ↓ Down Arrow key automatically creates a blank entry for entering a new step in the program. In Review Mode, when the last step of the program being reviewed is displayed and the user presses the ↓ Down Arrow key, the system asks the user if a new step needs to be entered.

STOP The STOP key notifies the system that the user wants to exit the task/mode that is currently active: During Program and Review Modes pressing the STOP key will be an indication that the creation of new program or the review and edit of an existing program is completed by the user. If a new program was being created or an existing program was modified, the system will prompt the user whether the new data should be saved or not.

CLEAR In Review Mode, the CLEAR key is used for deleting a step of an existing Program. A step cannot be deleted in the Program Mode.

The CLEAR key is NEVER used to clear a numeric data entry. To clear a numeric data entry the user simply has to keep on pressing extra zeros until only zeros are displayed in the field and then enter the new number.



PROG The PROG key serves two purposes:

- In **Standby Mode**, pressing the PROG key initiates programming of a new staining protocol.
- In **Review Mode**, pressing PROG key allows the user to insert a new step just above the currently displayed step.

Create a New Program

When the PROG key is pressed, the following information is displayed.

PRESS 1-9 FOR PROG #	← Use numbers on keypad to enter program # 1-15
STOP: SAVE AND EXIT	← STOP is used to Save and Exit a program
ENTER: ACCEPT VALUE	← ENTER is used to accept a value
0: NO, NORMAL SPEED 1: YES, FAST SPEED	← Keys 0 and 1 are used to select options for criticality, dips, exit speed

This screen shows the function of different keys for programming a run. The Up and Down arrow keys move from one step to another, the STOP key allows to exit the programming mode and the ENTER key accepts the numerical data and moves to the next parameter field. '0' and '1' keys are used to select NO and YES or Normal and Fast Exit Speed values.

Enter a program number 1 - 15. (Program 1 is pre-loaded and cannot be edited or deleted.) The system searches for the selected program. The following screen is displayed briefly.

```
CHECKING MEMORY FOR
EXISTING PROGRAMS .

PLEASE WAIT . . .
```

If the selected program already exists (for example '3') the following screen will be displayed.



```
PROGRAM 03 EXISTS!  
  
REVIEW: VIEW PROGRAM  
CLEAR: ERASE IT.  
STOP: EXIT.
```

If a program already exists,
REVIEW = view program
CLEAR = erase entire program
STOP = exit and return to main screen

If a program does not exist, the display presents step 1 of a program. The operator programs the actions for the step as described below.

```
Step # (1-35 possible) → STEP 01  
Program # (1-15 possible) → PROG 03  
  
  (1)                (2)  
STA                 TIME  
*00                 00:00  
  (3)                (4)    (5)  
CRIT                DIP    EXIT  
NO                  YES    NORM
```

5 fields to enter actions for that program step - numbered in red to demonstrate the sequence

* indicates the field being edited

↓ = next step
STOP = exit
CLEAR = delete step

The first two lines of the display show the step number and the program number that is being created. The fourth line of the display shows that the station number and the station time have not been programmed for this step yet. An asterisk symbol (“*”) under STA indicates that the Station number entry is expected. The last two lines of the display show that Criticality has been selected as ‘Not critical’, Agitation (dipping) and ‘Normal exit speed’ has been selected by default for this step. The user can enter a station number followed by ENTER key and the asterisk symbol (“*”) will move to the TIME selection. Station number and Station Time parameters need numerical entry followed by ENTER key. The other three parameters – Criticality, Dipping and Exit Speed – are selected by pressing 0 or 1 key for desired value.

The ENTER key can be used to go from one parameter to another. Once all the parameters for a given step are appropriately set, the user may press the down arrow key to move to the next step. If all steps are programmed for a given program, press the STOP key. At this point the user may:

- Save the newly created program by pressing ENTER
- Exit without saving and lose the new program by pressing CLEAR



The following screen is shown.

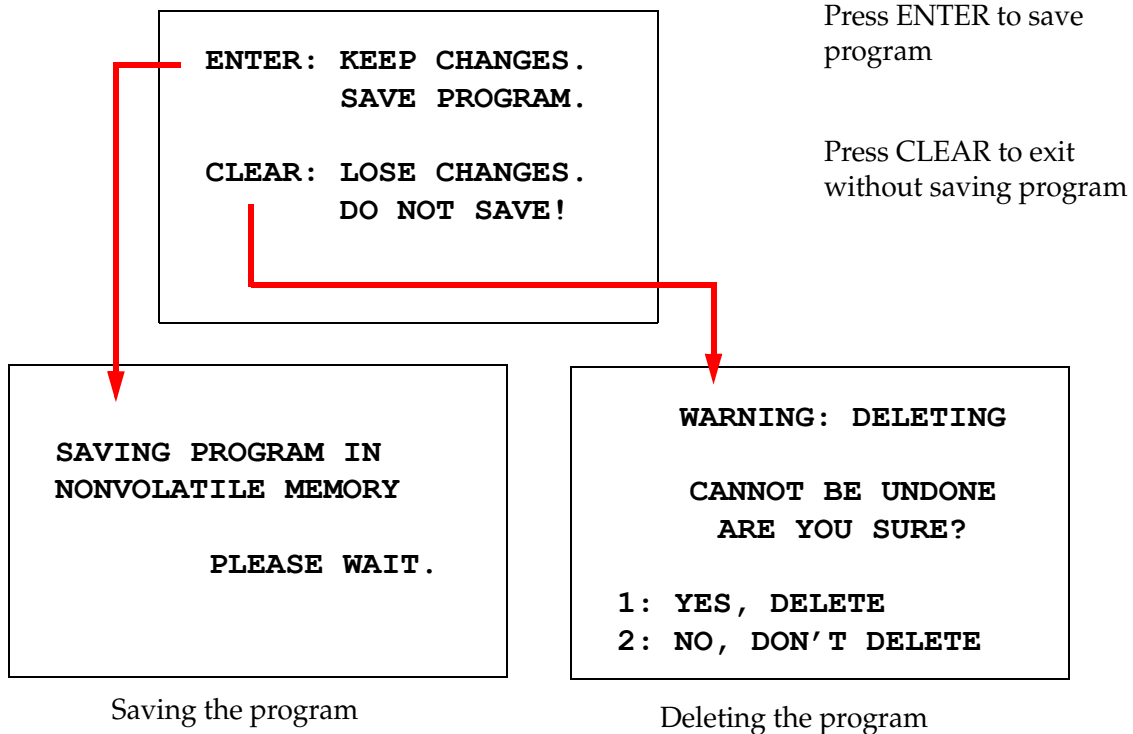

The user can save the program by pressing the ENTER key and the screen shown above will be displayed while the system is saving the program in the non-volatile memory.

Once the program is saved, the Standby screen is displayed.

Review and Edit a Program

An existing program can be reviewed and edited by the user by pressing the REVIEW key followed by the program number. The system will check memory for existence of that program.

The first step of the selected program is displayed in the same manner as if a new step was being programmed as explained above, however, the previously saved parameter values of the step are displayed. The user can navigate the steps by pressing up or down arrow keys, can change the parameter values or exit as explained before.

In the event the down arrow key is pressed when the last step is being displayed, the system asks if a new step needs to be added at the end by displaying the following screen.



ADD ANOTHER STEP?

1 = YES
0 = NO

Press 1 to add another step

Press 0 for no new step
(return to previous screen)

If the user presses '0' to indicate that a new step is not needed, the system returns to the last screen displayed. To end the review, press STOP to exit.

Insert a Step

While reviewing a program, you can insert a step just above the step that you are reviewing. Press PROG key to start inserting a step and fill in the Station, Time, Criticality, Dip and Exit fields, as shown on page 1.31. All fields must be entered, or a system warning appears:

STEP IS NOT COMPLETE
ENTER: FINISH STEP
CLEAR: QUIT NOW!

Press ENTER to finish the step (and any remaining steps, too)

Press CLEAR to quit immediately (no changes made)

When all fields for the inserted step are complete, press the ↓arrow to review any steps remaining in the program.

If editing was made to the program during a review, a message will be displayed when STOP is pressed, prompting the operator to save or clear the edits:

ENTER: KEEP CHANGES .
SAVE PROGRAM .

CLEAR: LOSE CHANGES .
DO NOT SAVE!



Delete a Step

To delete the step being reviewed, press the CLEAR key. The following warning is displayed:

**WARNING: DELETING
CANNOT BE UNDONE**

ARE YOU SURE?

1: YES, DELETE STEP

0: NO, DON'T DELETE

Delete cannot be undone.

Press 1 to delete the step

Press 0 to cancel delete
action

In the Review Mode, the user can erase the existing program from the memory by pressing the CLEAR key. To exit the review mode and go back to the standby screen, the user can press STOP.



Utility Menu

The software provides access to the following Utility functions when the UTIL key pressed.

```
1 CONTRAST
2 AGITATION
3 PROGRAMS
4 PASSWORD
5 EVENT LOG

SELECT UTILITY 1-5
```

Contrast

Contrast utility allows the user to adjust the contrast of the LCD display for best looking display from the desired viewing angle. Use the $\uparrow\downarrow$ keys to adjust the contrast and then press STOP to save the setting and exit.

```
CONTRAST UTILITY:

USE  $\uparrow\downarrow$  KEYS TO
ADJUST CONTRAST
ON THE DISPLAY.

PRESS STOP TO EXIT.
```



Agitation

Agitation utility allows the user to select the number of dips and the agitation stroke height during run. The number of dips can be set to any number between 1 and 10, inclusive. The dipping stroke can be set to either a 20 mm or 30 mm height.

PRESS 1 TO SELECT
THE NUMBER OF DIPS.

PRESS 2 TO SELECT
THE DIPPING STROKE

PRESS STOP TO EXIT.

NUMBER OF DIPS: 10

RANGE IS 1 TO 10.

ENTER: ACCEPT NUMBER
STOP: KEEP PREVIOUS

DIP STROKE: 20 MM

↑↓: OTHER VALUE

ENTER: ACCEPT NUMBER
STOP: KEEP PREVIOUS

Programs

Program utility allows the user to export and import the programs using a USB flash drive inserted at the rear of the system (refer to Figure 1-3). Exporting the programs to a flash drive is a good way to backup the protocols that have been developed.

1: EXPORT PROGRAMS

2: IMPORT PROGRAMS

PRESS STOP TO EXIT.

Important Operational Notes:

- All 15 programs will import or export together. Individual protocols cannot be selected and moved.



- Note that the Import function will overwrite any protocols already on the system!
- The storage capacity of the USB flash drive should be 4GB or less for optimal performance.

Export Programs

The export function allows the user to save programs to a USB drive. Place a USB drive in the port at the rear of the stainer. Select Export. The programs will be copied to the flash drive. The instrument beeps every 3 seconds during the transfer.

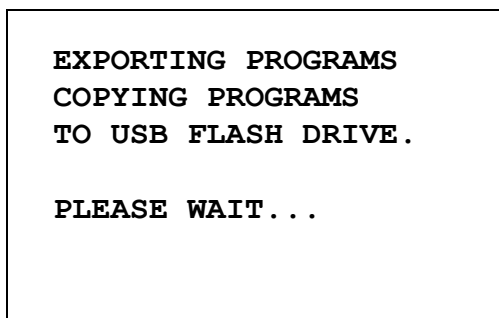

The programs are copied to the USB drive.
The instrument beeps during transfer.

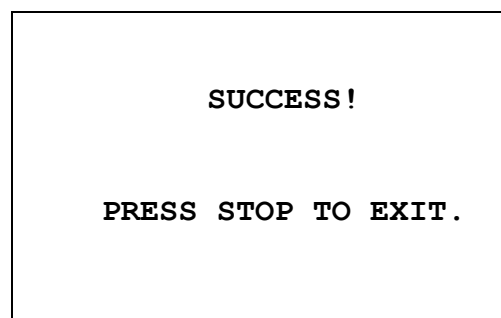

File export complete. Press STOP to exit.

When export has completed, press STOP to exit the utility. Remove the USB drive from the port.

The file on the USB drive is an ASCII (text) file named OLD_PROG.RSF. This file contains all 15 programs (even if programs are empty).

If programs are exported to a USB drive and then the same drive is used again for export, the old program OLD_PROG.RSF should be deleted off the drive first. Otherwise, the program files keep appending to the end of the original file.

Import Programs

To import program files to the Compass Stainer, the name of the file on the USB must be changed to NEW_PROG.RSF.

Place the USB drive in the port on the rear of the instrument. Select Import. The programs will be copied from the flash drive. The instrument beeps every 3 seconds during the transfer.



**IMPORTING PROGRAMS
COPYING PROGRAMS
FROM USB FLASH DRIVE.

PLEASE WAIT...**

The programs are copied from the USB drive.
The instrument beeps during transfer.

**SUCCESS!

PRESS STOP TO EXIT.**

File import complete. Press STOP to
exit.

When import has completed, press STOP to exit the utility. Remove the USB drive from the port.

When the programs are imported, the first program (ThinPrep protocol) is ignored and all remaining programs (2-15) in the stainer memory are overwritten.

Password Implementation

Password utility allows the user to set or change the password.

**ENTER NEW PASSWORD:

0000

USE THE NUMBER KEYS,
THEN PRESS ENTER.**

The Password menu allows you to set and change a 4-digit Password for the system. The system is shipped with no password set. A password of 0000 implies that the password use is deactivated.

To set a password, select the PASSWORD selection in Utility menu and enter the new password. The system prompts you to enter it again. If the numbers don't match, an error message is displayed. If the two numbers are the same, the new password will be saved.

It must then be entered correctly whenever the operator attempts to PROGRAM, or REVIEW a program or to enter the UTILITY mode. For operator's convenience, once the password entry has been entered correctly, PROGRAM, REVIEW and UTILITY menus are accessible for a period of 5 minutes without re-entering the password. For example, this allows the operator to review more than one program without re-entering the password over and over again.



Running a staining program DOES NOT require a password entry.
To deactivate the password protection, enter 0000 as new password.

Event Log

Event Log utility provides the information regarding various events that took place during the last run. Every station step and time is recorded. The system captures up to 130 steps and then purges the oldest as newer events are added.

1. VIEW EVENT LOG

MAKE A SELECTION.

**USE ↑↓: TO SCROLL
THROUGH EVENT LOG.**

PRESS STOP TO EXIT.

Press 1 to view the event log. Use the ↑↓ arrows to scroll through the event log. Press STOP to exit.

Rack #	Station #	Station Time (time spent at the station)	Program Time in seconds (total accumulated run time for the rack)
R1	S22	03:00	01624.3
R1	S23	00:00	01810.2
R1	ENDED P01		01812.8
R2	S01	01:00	00020.4
R2	S02	01:00	00086.3
R2	PAUSED		00152.2
R2	RESUMED		00153.3
R2	S03	00:10	00166.0

This example is of a run with multiple racks, using Program 1
Staining rack 1 finished, running Program 1.
Next staining rack started.
Run paused and resumed



MAINTENANCE

General Information

- DO switch off the stainer before cleaning
- DO NOT use excessive amounts of solvent for cleaning
- DO NOT use metal scrapers or sharp objects to remove any residue as this will damage the surface finish and paints.
- DO NOT use the system for purposes other than its intended function
- DO practice good housekeeping and maintain the system in a clean condition
- DO ensure that replacement fuses are of the correct specification (1 Amp x 250 volts time delayed)

Routine Maintenance Schedule

Maintenance Activity	Daily	Weekly	Monthly or As Needed
Clean the keypad and the display window with a lint-free cloth.	X		
Clean outside surfaces of system and lid with soft cloth. Use cleaning detergent, if necessary.		X	
Remove and clean the reagent containers. A dishwasher up to 65°C (149°F) can be used.		X	
Replace charcoal filter.			X (every 6 months)

Cleaning Procedures

The Compass Stainer is designed to properly function under recommended settings. Please use the following instructions and cleaning procedures carefully.

- Turn off the stainer when cleaning. The stainer should always be disconnected from the main power supply when cleaning, particularly if flammable solvents are used.
- Use only minimal quantities of cleaning solvent (such as glass cleaner) on an absorbent cloth. Do NOT use Xylene and Xylene substitute as well as other decolorizing agents that can attack paint, plastic and other insulating materials. Do not use excessive amount of cleaning agent while wiping down the surfaces.
- Periodically clean the solution containers with 10% diluted bleach solution to minimize any growth of fungus.



Interior: Remove the reagent containers. Wipe the stainless-steel platform with a regular cleaner and then wipe with water to remove the residue of the cleaner.

Transport arm mechanism: Wipe down with a slightly moistened cloth.

Outside surfaces: Clean the painted outside surface with a mild detergent and subsequently wipe down with a moistened cloth. Do not use any solvents for cleaning the outside surfaces

Keypad and the Display Window: Use a commercial screen cleaner, glass cleaner or alcohol for cleaning the keypad and the display window. DO NOT USE Xylene, Xylene Substitutes, Acetone or other harsh chemicals on the keypad or the display window.

Reagent containers: Clean reagent containers using a standard laboratory detergent, rinse multiple times with water, followed by distilled water, then dry thoroughly. A dishwasher may be used if the maximum water temperature is no higher than 65°C (149°F).

Slide racks: Clean with household or laboratory cleaners, as needed.

Charcoal Filter Replacement (Once every 6 months, or as needed)

The charcoal filter is located in the back of the unit as shown in Figure 1-3. Lift the old filter to remove it and drop in a new one to replace the old one. Be sure to orient the filter so that the air flow is from the stainer side through to the outside.

Changing the Fuses (as needed)

The fuses are located in the power entry module, refer to Figure 1-3. To change the user accessible fuses, turn off and unplug the stainer from the power source. Remove the power cord from the connector located at the power entry module. Using a flat bladed screwdriver, gently pry off the cover to the fuse holder.

Pull the fuses out, noting the orientation for the replacement fuses. Remove and discard the fuses (they may go in regular laboratory trash). Replace with the new fuses and insert into the fuse holder. Snap the fuse holder cover back on and reconnect the power cord to the power entry module.

Plug the stainer in and turn it on. Confirm that the instrument powers up and the keypad display transitions to the standby mode screen. Contact Technical Support if the stainer does not work.



SERVICE INFORMATION

The Compass Stainer contains no user serviceable components. Contact Technical Support for all service requirements.

Corporate Address

Hologic, Inc.
250 Campus Drive
Marlborough, MA 01752 USA.

Customer Service

Product orders, which include standing orders, are placed through Customer Service by phone during business hours. Contact your local Hologic representative.

Warranty

A copy of Hologic's limited warranty and other terms and conditions of sale may be obtained by contacting Customer Service.

Technical Support

For technical support, contact your local Hologic Technical Solutions office or your local distributor.

For questions about Compass™ Stainer accessory issues and related application issues, representatives from Technical Support are available in Europe and the UK by phone 8.00 to 18.00 CET Monday through Friday, at TScytology@hologic.com and via the toll-free numbers listed here:

Finland	0800 114829
Sweden	020 797943
Ireland	1 800 554 144
United Kingdom	0800 0323318
France	0800 913659
Luxemburg	8002 7708
Spain	900 994197
Portugal	800 841034
Italy	800 786308
Netherlands	800 0226782
Belgium	0800 77378
Switzerland	0800 298921
EMEA	0800 8002 9892

While contacting Technical Support, please have the following information ready.

1. Model name and serial number of the system



2. Location of the system, and name of the person to contact and the contact information
3. Reason for the call

Protocol for Returned Goods

For returns on warranty-covered Compass™ Stainer accessory and consumable items, contact Technical Support.

Service contracts can also be ordered through Technical Support.



ORDERING INFORMATION

Mailing Address

Hologic, Inc.
250 Campus Drive
Marlborough, MA 01752 USA

Remittance Address

Hologic, Inc.
PO Box 3009
Boston, MA 02241-3009 USA

Business Hours

Hologic's business hours are 8:30 a.m. to 5:30 p.m. EST Monday through Friday, excluding holidays.

Customer Service

Product orders, which include standing orders, are placed through Customer Service by phone during business hours. Contact your local Hologic representative.

Warranty

A copy of Hologic's limited warranty and other terms and conditions of sale may be obtained by contacting Customer Service at the numbers listed above.

Protocol for Returned Goods

For returns on Compass Stainer accessory and consumable items, contact Technical Support.



OPTIONAL ACCESSORIES

Part Number	Description	Quantity
ASY-05576	Compass™ Stainer	1
OEM-01078	Reagent Containers with Lids	6
OEM-01079	Slide Rack 30 position (with RS adapter)	1
OEM-01080	Adapter for 30 Position Slide Rack	1
OEM-01100	Adapter for Sakura or Leica-20 Slide Rack	1
50077-013	Fuse (pack of 2 fuses) 5x20mm, T, Semko, 1 A	1
50080-001	Line Cord (USA & Canada)	1
50081-001	Line Cord (Europe)	1
50083-001	Line Cord (England)	1
MAN-08472-001	Operator Manual for Compass Stainer	1
PWR-00140	UPS, 1500VA, 120 VAC 50/60 Hz, RS series	1
PWR-00141	UPS, 1500VA, 230 VAC, 50/60 Hz, RS series	1
PKG-00852	Shipping Carton	1
PKG-00853	Packaging material	1 set
OEM-01081	Charcoal Filter	1
OEM-01082	Optional External Exhaust Hose Adapter	1
OEM-01083	Optional External Exhaust Hose, 9' long	1
OEM-01084	Fume Shield	1



TROUBLESHOOTING GUIDE

Symptom	Probable Causes	Suggested Actions
The unit does not power up	<ul style="list-style-type: none"> Unit not connected to the power outlet No power at the power outlet Power Switch in the OFF position 	<ul style="list-style-type: none"> Ensure that the power cord is plugged in at the outlet as well as in the rear of the unit. Check the circuit breaker for the power outlet and ensure that the power is available at the power outlet. Turn ON the power switch in the rear of the.
	<ul style="list-style-type: none"> Blown Fuse 	<ul style="list-style-type: none"> Check the fuses and replace any blown fuse with a fuse of the same rating. Investigate the cause for overload and correct the problem before re-starting the system.
Display does not power up	<ul style="list-style-type: none"> Communication between host and the Display controller not working or Display power is interrupted 	<ul style="list-style-type: none"> Contact Hologic Technical Support
Up-down mechanism does not initialize or move	<ul style="list-style-type: none"> Obstruction in the transport mechanism, mechanism does not move freely 	<ul style="list-style-type: none"> Remove any obstructions Contact Hologic Technical Support
	<ul style="list-style-type: none"> Defective PCB 	<ul style="list-style-type: none"> Contact Hologic Technical Support
	<ul style="list-style-type: none"> Defective Motor 	<ul style="list-style-type: none"> Contact Hologic Technical Support
	<ul style="list-style-type: none"> Broken Belt 	<ul style="list-style-type: none"> Contact Hologic Technical Support
Rotary mechanism does not initialize or move	<ul style="list-style-type: none"> Follow the same procedure as described above for up-down mechanism 	<ul style="list-style-type: none"> Follow the same procedure as described above for up-down mechanism



Staining Protocol, 95% Reagent Alcohol Fixed ThinPrep™ Slides for Use with ThinPrep Imaging

Equipment: Hologic Compass Stainer Agitation: Dips = 10, Height = 30 mm
Exit speed = Normal

Run no more than four slide racks together. Wait for all four to be unloaded before adding new racks.

Caution: Change the Distilled / Instrument Feed Water bath at **Station 5** after every **four** racks of slides. Maintain bath heights to completely cover the slides at full immersion.

Note: Bath fill volume = 360 ml.

Station	Time	Duration	Solution
LOAD	n/a	n/a	95% Reagent or Ethyl alcohol
1	01'00"	Non-critical	70% Reagent or Ethyl alcohol
2	01'00"	Non-critical	50% Reagent or Ethyl alcohol
3	01'00"	Non-critical	Distilled or Instrument Feed Water (IFW) ^a
4	07'00"	Critical	ThinPrep Nuclear Stain
5	00'10"	Critical	Distilled or Instrument Feed Water (IFW) ^a (Replace after every 4 racks.)
6	01'00"	Critical	ThinPrep Rinse Solution
7	00'30"	Non-critical	Distilled or Instrument Feed Water (IFW) ^a
8	00'30"	Critical	ThinPrep Bluing Solution
9	00'30"	Non-critical	Distilled or Instrument Feed Water (IFW) ^a
10	00'30"	Non-critical	50% Reagent or Ethyl alcohol
11	00'30"	Non-critical	95% Reagent or Ethyl alcohol
12	02'00"	Critical	ThinPrep Orange G Solution
13	00'15"	Critical	95% Reagent or Ethyl alcohol
14	00'15"	Critical	95% Reagent or Ethyl alcohol
15	04'00"	Critical	ThinPrep EA Solution
16	01'00"	Critical	95% Reagent or Ethyl alcohol
17	01'00"	Critical	95% Reagent or Ethyl alcohol
18	00'30"	Non-critical	100% Reagent or Ethyl alcohol
19	00'30"	Non-critical	100% Reagent or Ethyl alcohol
20	00'30"	Non-critical	100% Reagent or Ethyl alcohol
21	01'00"	Non-critical	Xylene or other Hologic approved clearing agent ^b
22	03'00"	Non-critical	Xylene or other Hologic approved clearing agent ^b
UNLOAD	n/a	n/a	Xylene or other Hologic approved clearing agent ^b

a. Hologic specification for IFW: ≥ 1.0 megohm-cm Resistivity OR ≤ 1.0 μ Siemens/cm Conductivity (Refer to Clinical and Laboratory Standards Institute (CLSI) document C3-A4, 2006)

b. See ThinPrep Stain User's Manual, Section 1, "STAINING" or contact Hologic for current list of Hologic approved clearing agents and mounting medias



Solution Stations for Staining 95% Reagent Alcohol Fixed ThinPrep Slides

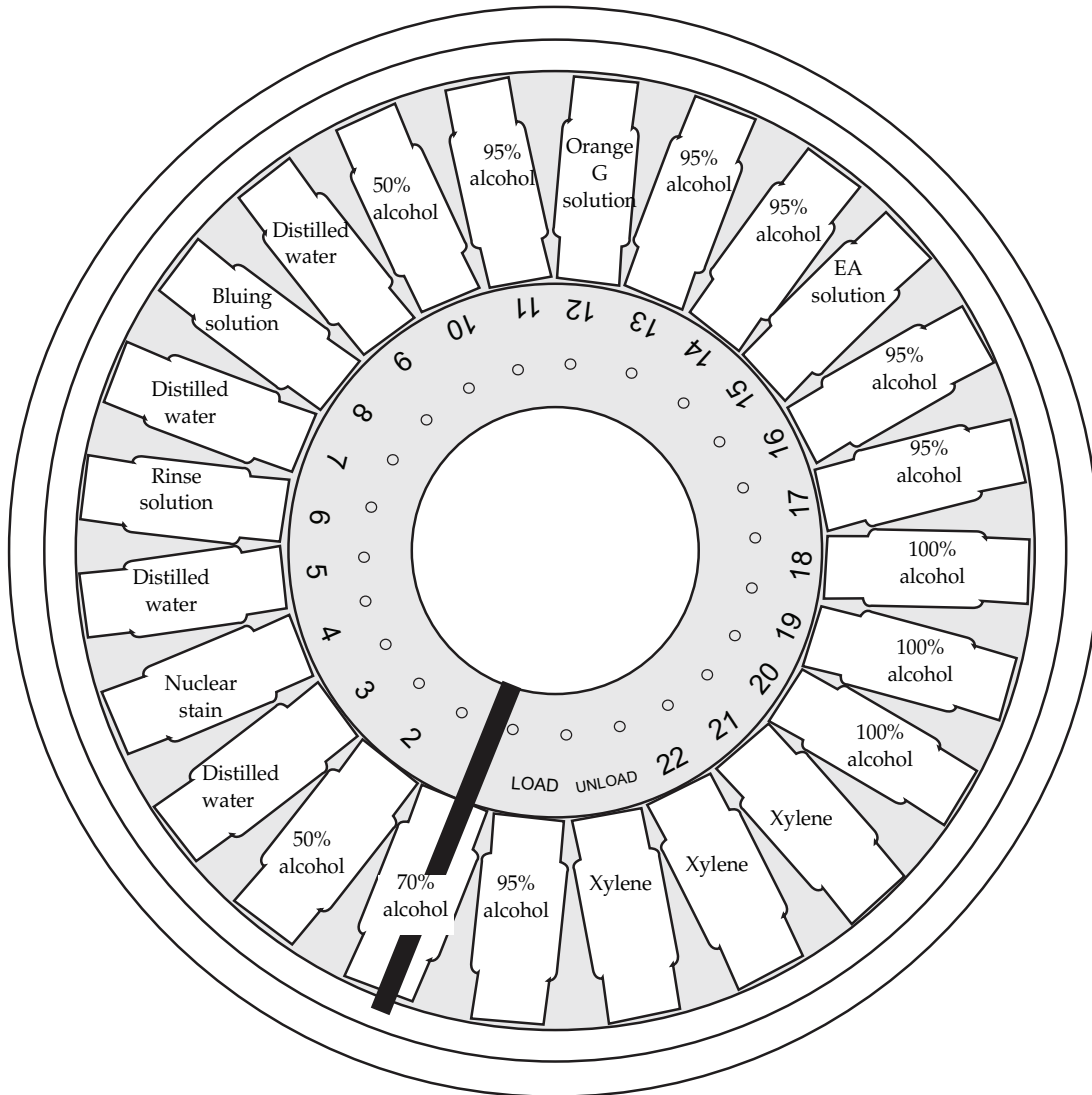

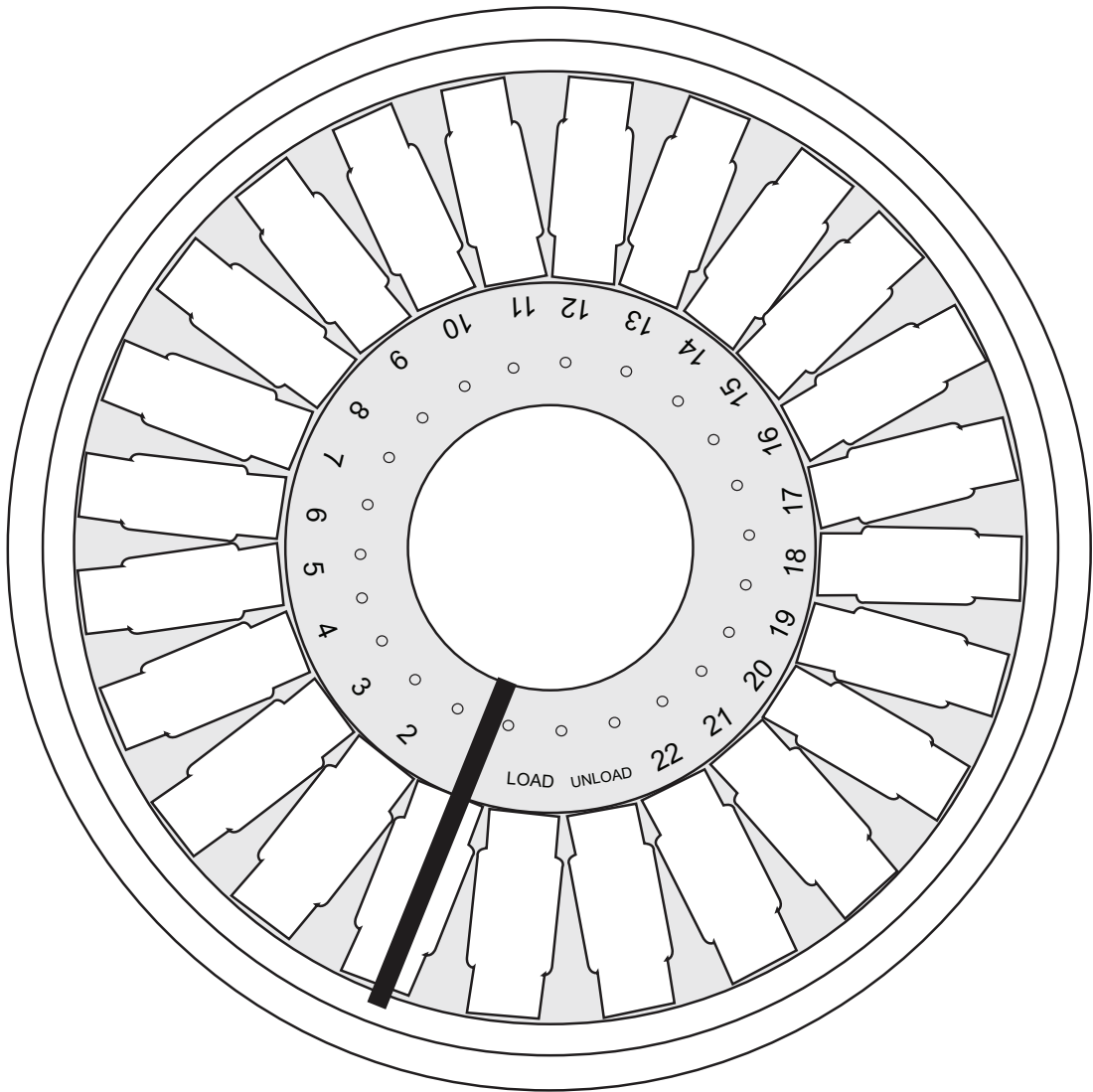

LOAD		12	
1		13	
2		14	
3		15	
4		16	
5		17	
6		18	
7		19	
8		20	
9		21	
10		22	
11		UNLOAD	

Worksheet for stain protocols. This worksheet may be photocopied.



This page intentionally left blank.