

Omni™ Lok Quick Reference Guide

HOLOGIC®

Indications for Use

The Omni Lok cervical seal is used during a hysteroscopic procedure to minimise liquid distention media leakage from the cervix.

Contraindications

The Omni Lok cervical seal should not be used in a patient with contraindications to hysteroscopy.

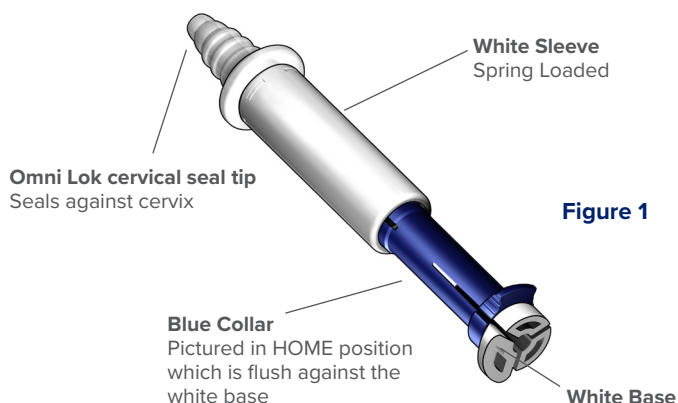

Figure 1

IF THE 50-250XL MYOSURE® XL ROD LENS HYSTEROSCOPE IS BEING USED, TRIM THE TIP PER INSTRUCTIONS BELOW:

The tip needs to be trimmed in order to accommodate the larger scope diameter of the MyoSure XL Rod Lens Hysteroscope. Use scissors to cut the proximal end of the seal tip at the location on the first rib as indicated in Figure 2. If the device is not cut in this location, it cannot be used with the 50-250XL MyoSure XL Hysteroscope. Inspect the tip following trimming to ensure there is no extra hanging material, no rough edges, etc. prior to use.

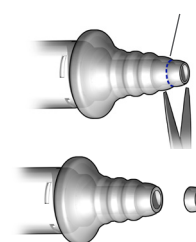

Figure 2

Operation

- For all compatible Hysteroscopes:
Simply slide the proximal end of the cervical seal onto the distal end of the hysteroscope. Hold the device by aligning the white spring loaded sleeve and blue collar in one hand as shown in Figure 3. To allow for ease of entry, angle the hysteroscope slightly as it's introduced to the white base.

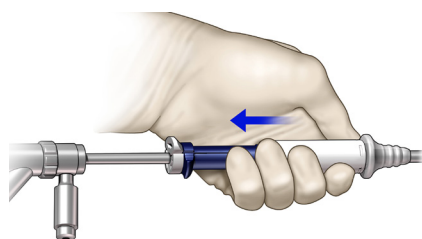

Figure 3

NOTE: The white base of the cervical seal device will expand to accommodate the hysteroscope diameter as shown in Figure 4. The cervical seal grips the hysteroscope, but does not “lock” on the scope. The device will not slide any further on the hysteroscope once it is flush with the hysteroscope as shown in Figure 5.

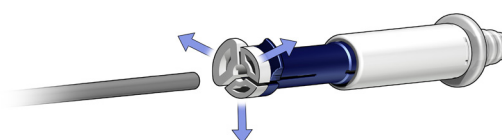

Figure 4

- Advance the cervical seal to the desired location on the scope based on user preference. At a minimum the scope should protrude slightly from the distal end of the cervical seal prior to advancing the hysteroscope into the external os.

NOTE: The orientation of the cervical seal on the hysteroscope does not matter.

The blue tab and white tab must maintain the orientation as packaged. DO NOT twist or rotate the tabs with respect to each other as shown in Figure 7.

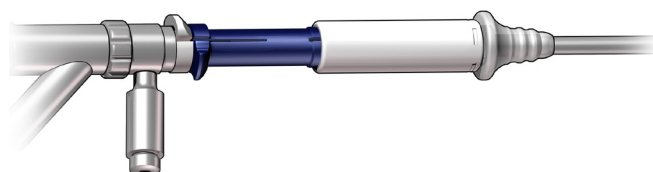

Figure 5

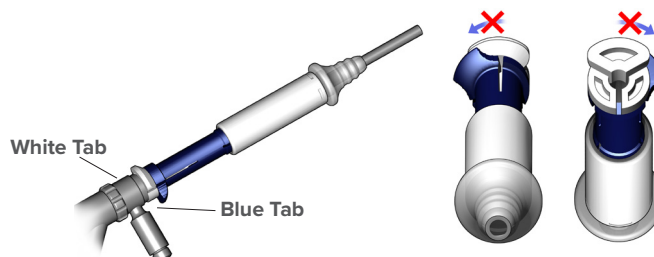

Figure 6

Figure 7

Omni™ Lok
Cervical Seal

3. To extend the overall length of the cervical seal, an optional device feature can be used.

Figure 8
“HOME” position, as packaged

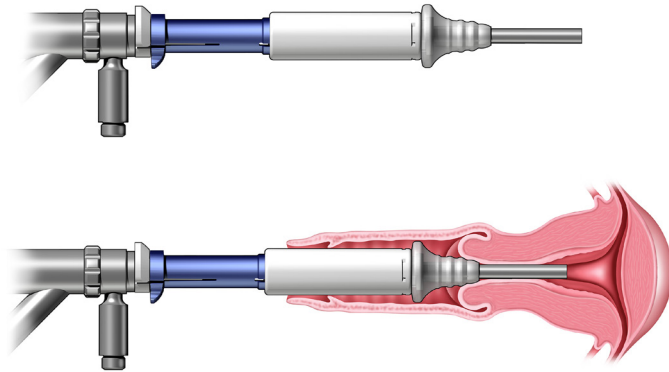
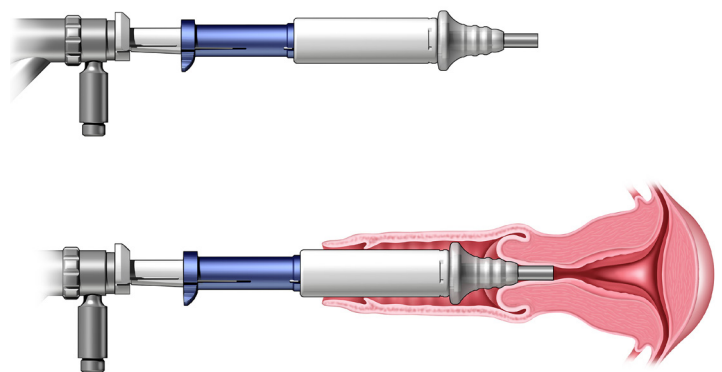

Figure 9
“EXTENDED”



To change the cervical seal from the “HOME” configuration (as packaged in the pouch, Figure 8) to the “EXTENDED” position (Figure 9),

- Under visualisation, hold the hysteroscope with one hand. Ensure the **white base** is flush against the hysteroscope. Place a finger or thumb on the white tab of the base with the same hand that is holding the scope to secure the **white tab**.
- With the other hand, push the blue tab on the blue collar forward (Figure 10) until it locks into the “EXTENDED” position shown in Figure 9.

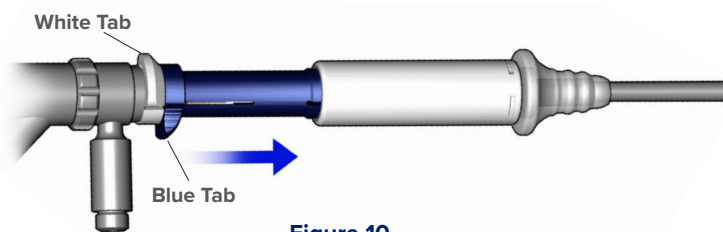

Figure 10

4. To change the cervical seal from the “EXTENDED” position to the “HOME” position:

- Under visualisation, hold the hysteroscope with one hand. Ensure that the **white base** is flush against the hysteroscope. Place a finger or thumb on the white tab of the base with the same hand that is holding the hysteroscope.
- As shown in Figure 11, with the other hand, grasp the **blue tab** and lift it up and over the step on the white base (1). Slide the **blue tab** to the “HOME” position, until it is flush with the white base (2).

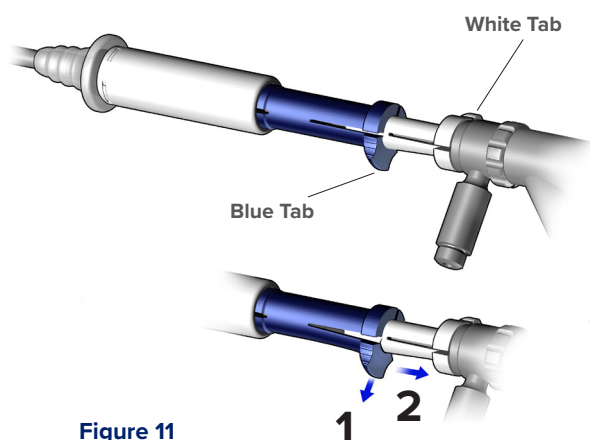

Figure 11

This Quick Reference Guide is designed to be used in conjunction with, not replace, the Omni Lok cervical seal Instructions for Use. Prior to performing the procedure, the physician must review and be familiar with the full operating instructions for the Omni Lok cervical seal, as well as any warnings, contraindications, and safety information.

MISC-05963-EUR-EN Rev 001 © 2020 Hologic Inc. All rights reserved. Hologic, MyoSure and Omni associated logos are trademarks or registered trademarks of Hologic, Inc. and/or its subsidiaries in the United States and/or other countries. This information is intended for medical professionals and is not intended as a product solicitation or promotion where such activities are prohibited. Because Hologic materials are distributed through websites, eBroadcasts and tradeshow, it is not always possible to control where such materials appear. For specific information on what products are available for sale in a particular country, please contact your local Hologic representative or write to euinfo@hologic.com